



Wall Type Fans





Wall Type Fans



Contents

Wall Type Square Casing Industrial Ventilation Series

2

Wall Type Square Casing Industrial Ventilation Series

10

Wall Type Square Casing Industrial Ventilation Series

Aironn AIR-KKSA Series fans are suitable to operate at maximum 55 °C. In order for you to make a selection to meet your need, 11 different models are available. They have axial fan blades.

Fan Body

They are made of electrostatic powder coated DKP sheet metal in square cages.

Fan Blades

Concave Fan Blade System with 6 Blades is made of plastic. The wheels are statically and dynamically balanced in compliance with ISO 1940/1-2003.

Motor

B insulation class motor is inside the air flow.

Electricity

Electric switch box is not included.

Accessories

Speed Control Switch, Damper



Wall Type Square Casing Industrial Ventilation Series

Dimensions

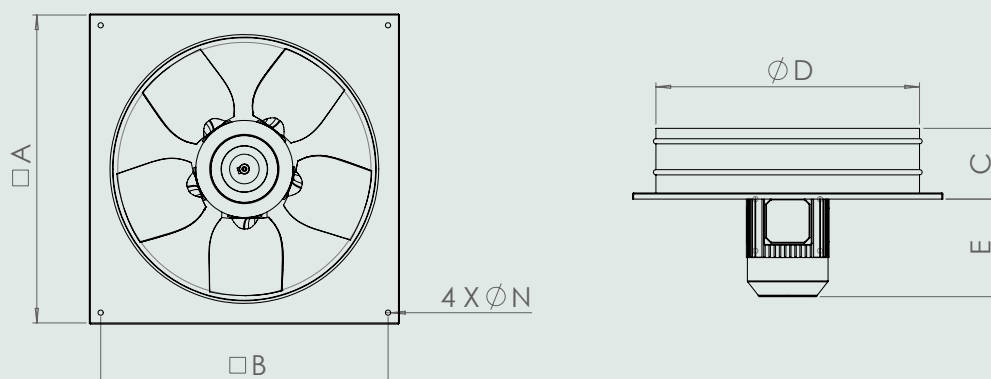

	A	B	C	D	E	Ø N
AIR-KKSA 250	333	275	80	261	80	8
AIR-KKSA 300	412	336	80	307	80	8
AIR-KKSA 350	465	390	90	364	80	8
AIR-KKSA 400	500	420	100	403	80	8
AIR-KKSA 450	560	480	105	462	80	8
AIR-KKSA 500	630	561	110	513	90	8
AIR-KKSA 600	700	550	125	610	239	10
AIR-KKSA 700	800	640	1270	730	259	10
AIR-KKSA 800	950	770	220	830	284	10
AIR-KKSA 900	1100	900	250	930	336	12
AIR-KKSA 1000	1200	960	250	1030	375	12

Type	Voltage V	Frequency Hz	Motor Power W	Current A	Motor Speed d / d	Condenser µF	Noise dBA	Weight kg
AIR-KKSA 250	230 / 380	50	190	1,1	1475	8	60	7,3
AIR-KKSA 300	230 / 380	50	210	1,1	1445	8	60	8,5
AIR-KKSA 350	230 / 380	50	270	1,3	1400	8	63	9,9
AIR-KKSA 400	230 / 380	50	310	1,4	1350	8	65	10,4
AIR-KKSA 450	230 / 380	50	360	1,6	1240	8	66	11,4
AIR-KKSA 500	230 / 380	50	440	2	1130	8	68	13,6
AIR-KKSA 600	230 / 380	50	0,75	4,6 / 2	1400	-	75	20,5
AIR-KKSA 700	230 / 380	50	1,1	7.1 / 2.6	1400	-	82	33
AIR-KKSA 800	230 / 380	50	2,2	13.4 / 5.1	1400	-	85	52
AIR-KKSA 900	380	50	4	8,2	1400	-	88	61
AIR-KKSA 1000	380	50	5,5	11,3	1400	-	91	90

Wall Type Square Casing Industrial Ventilation Series

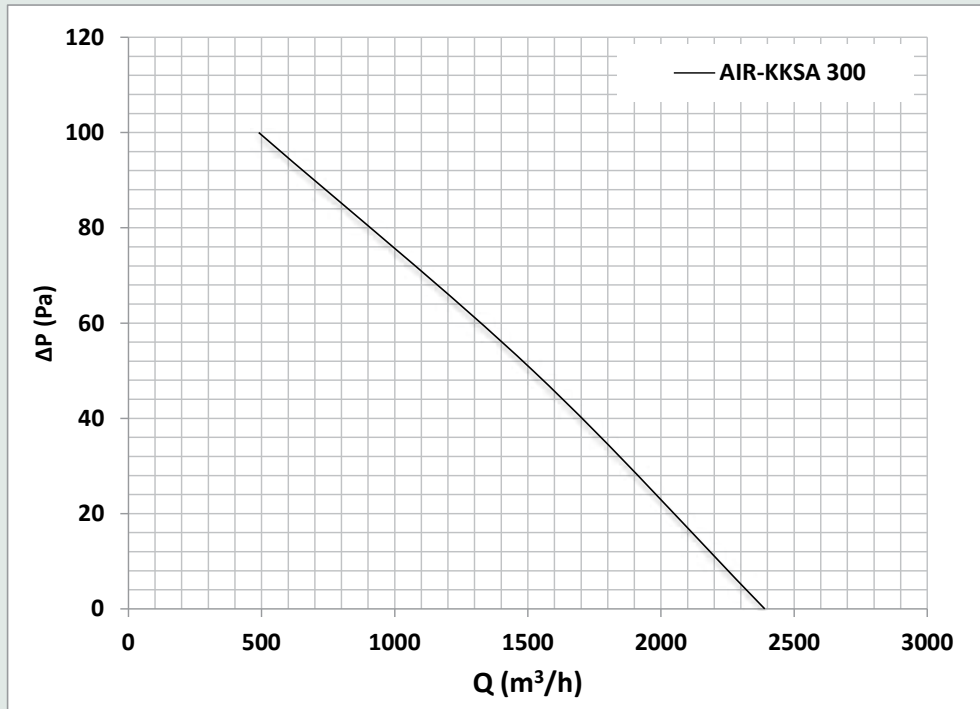
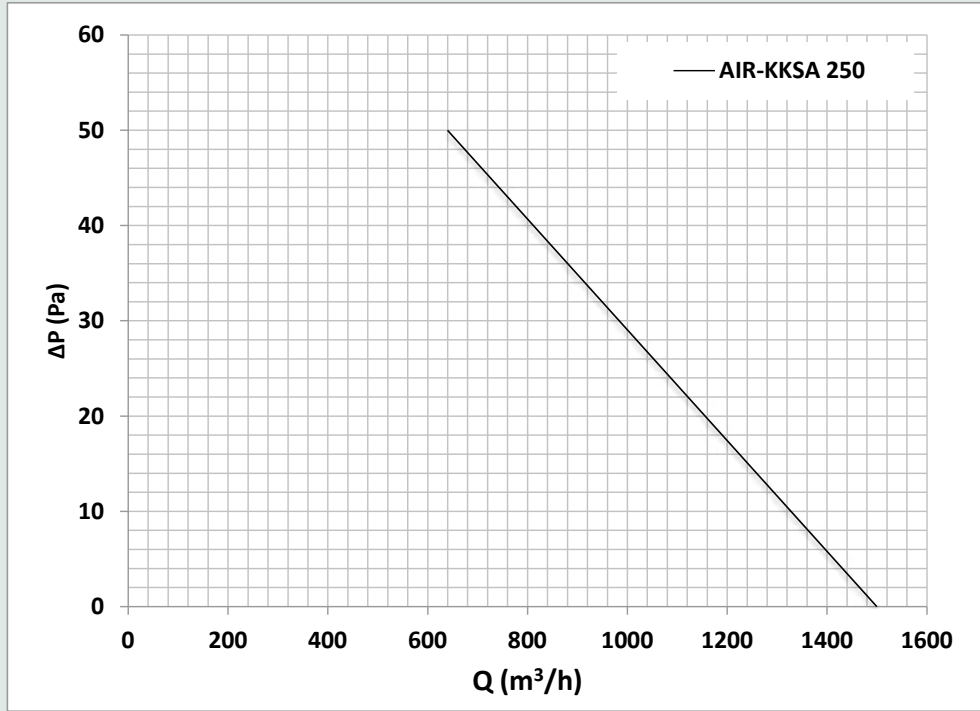

Wall Type Square Casing Industrial Ventilation Series

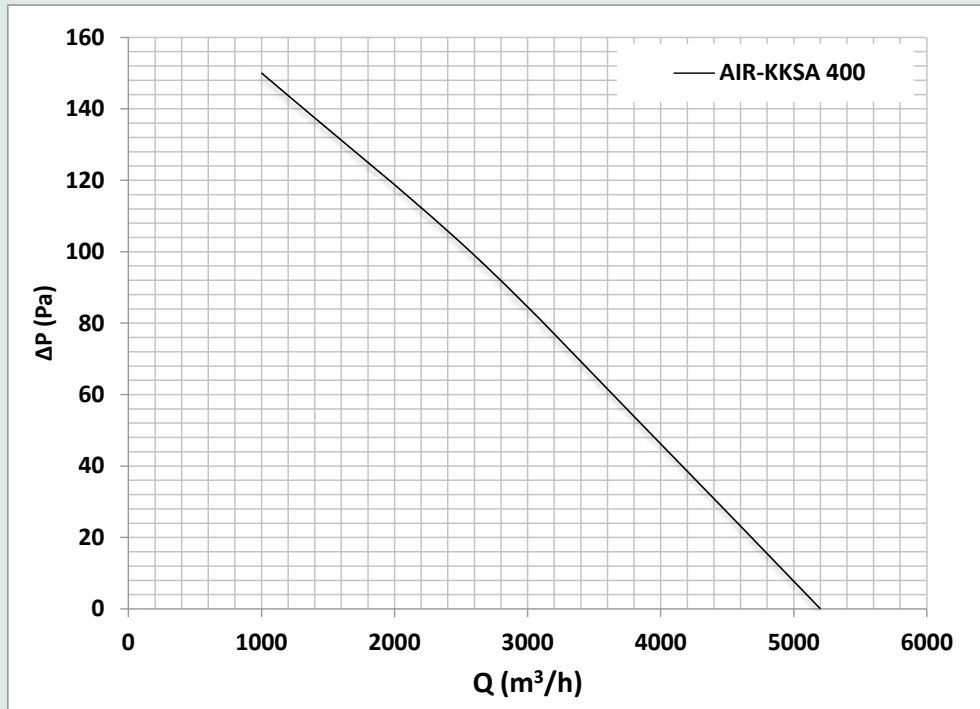
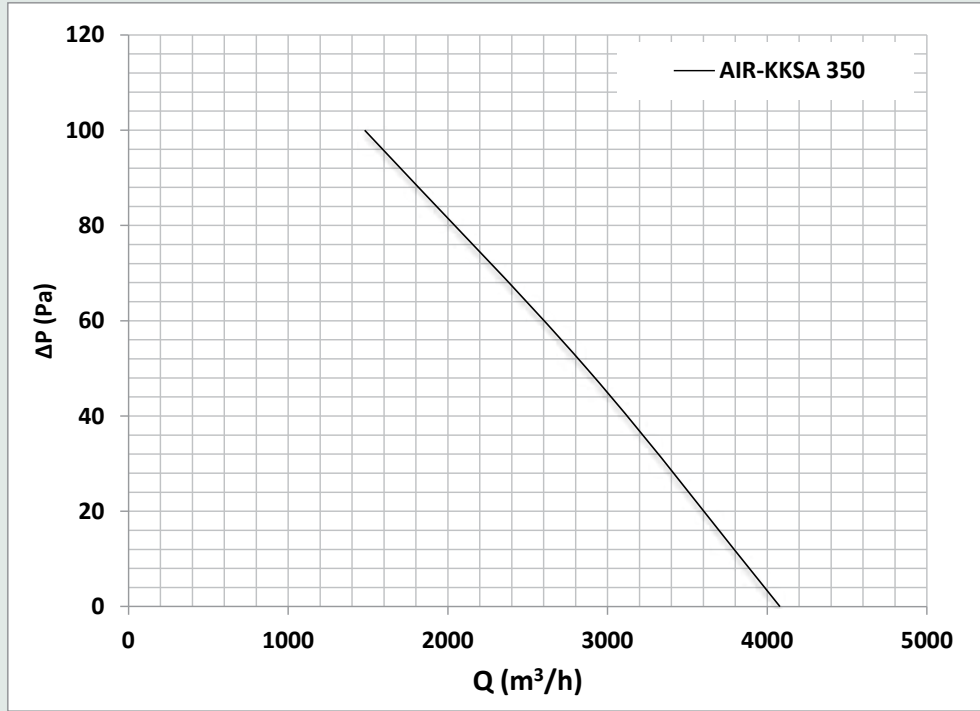

Wall Type Square Casing Industrial Ventilation Series

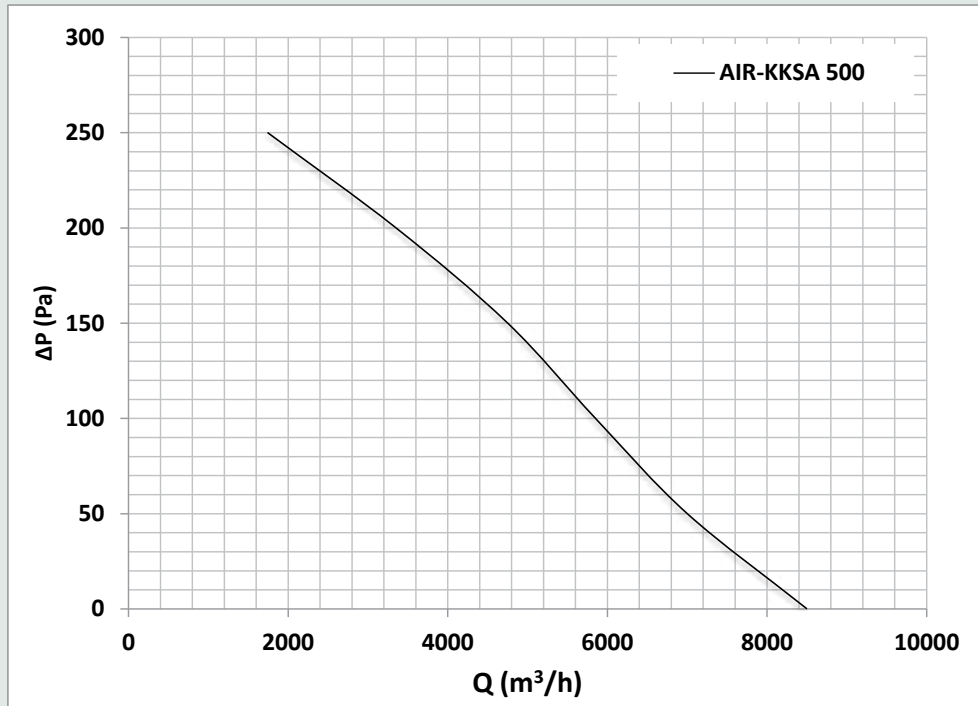
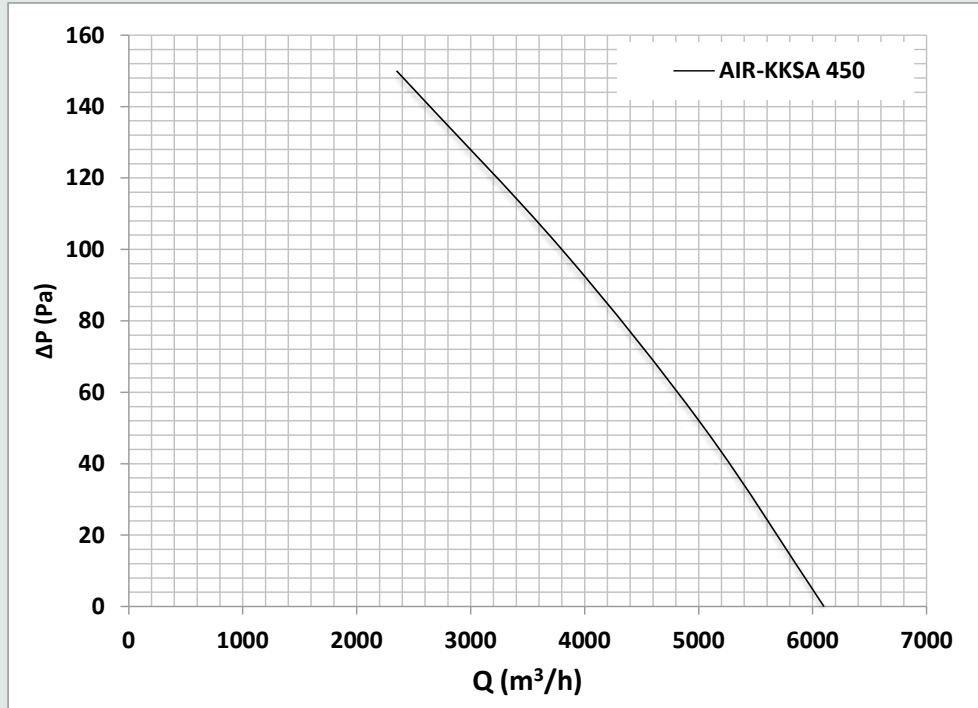

Wall Type Square Casing Industrial Ventilation Series

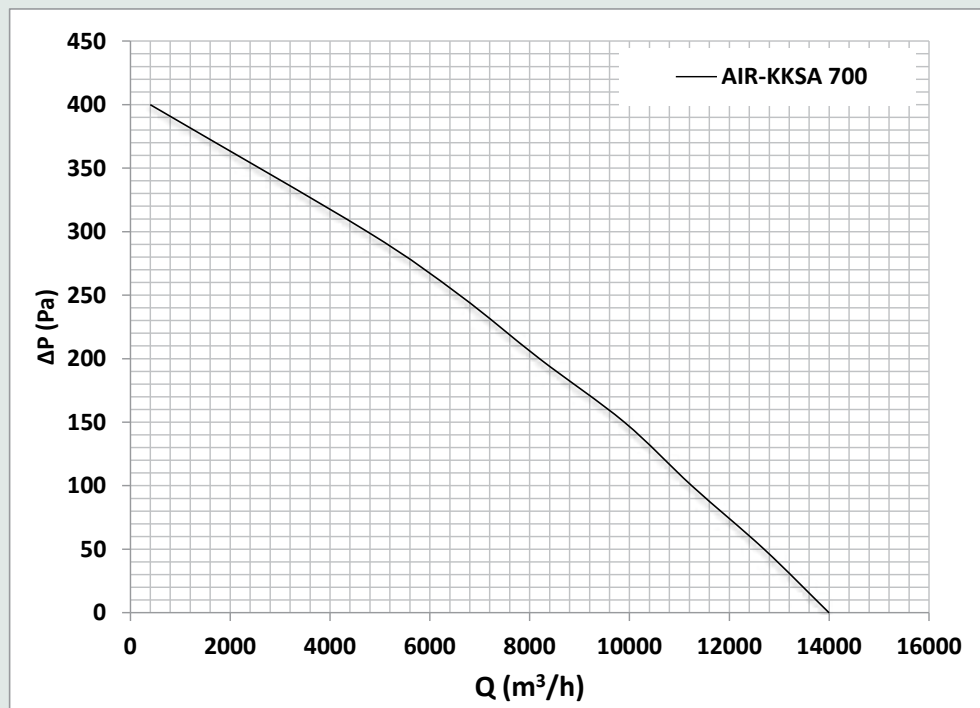
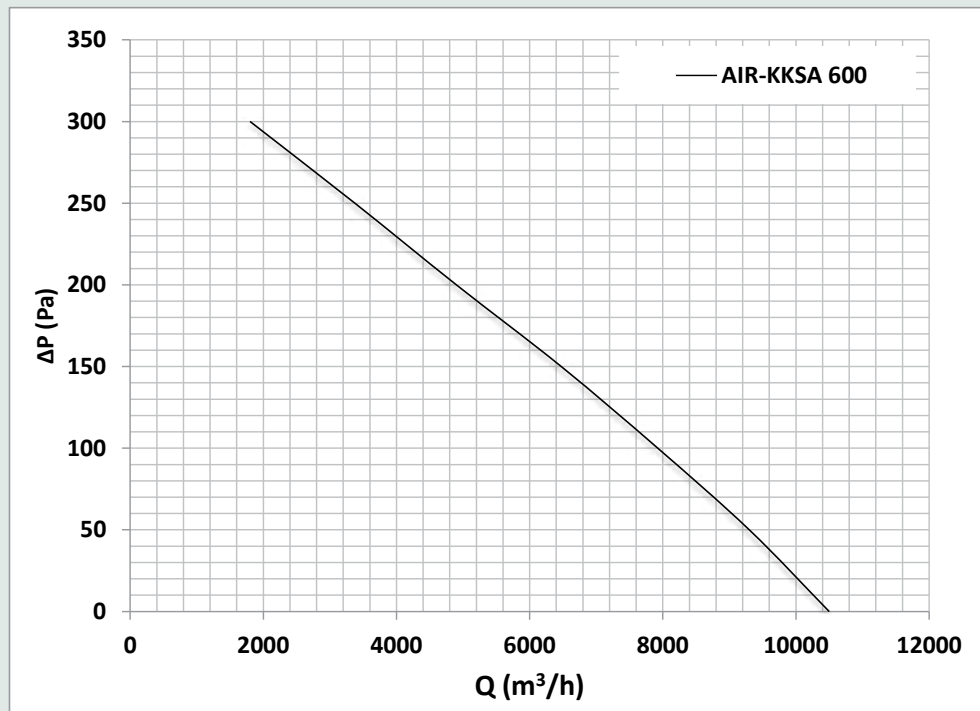

Wall Type Square Casing Industrial Ventilation Series

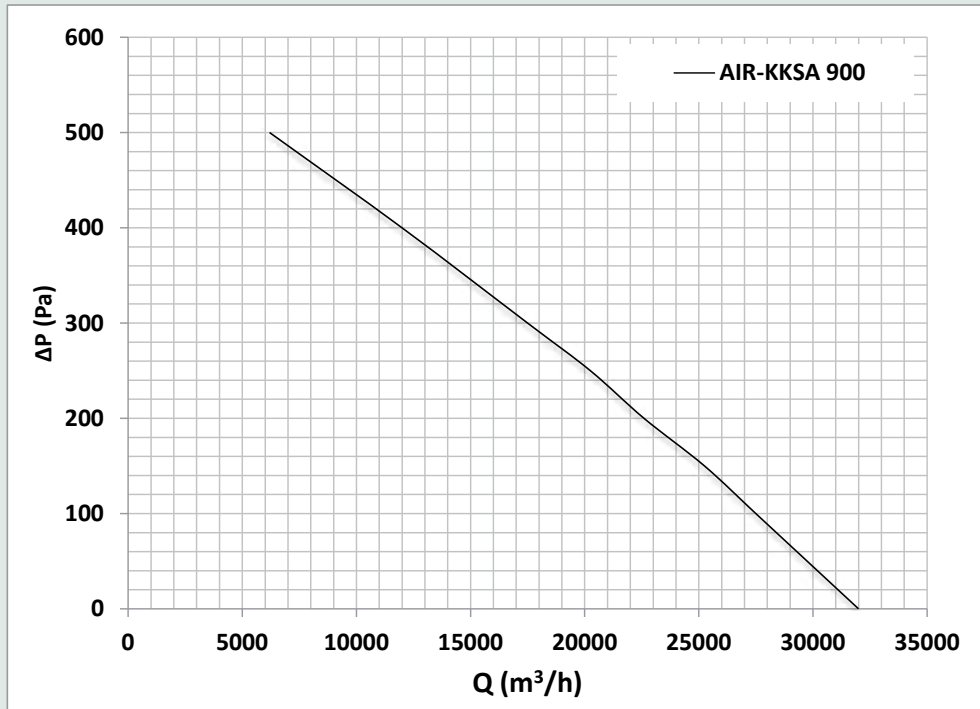
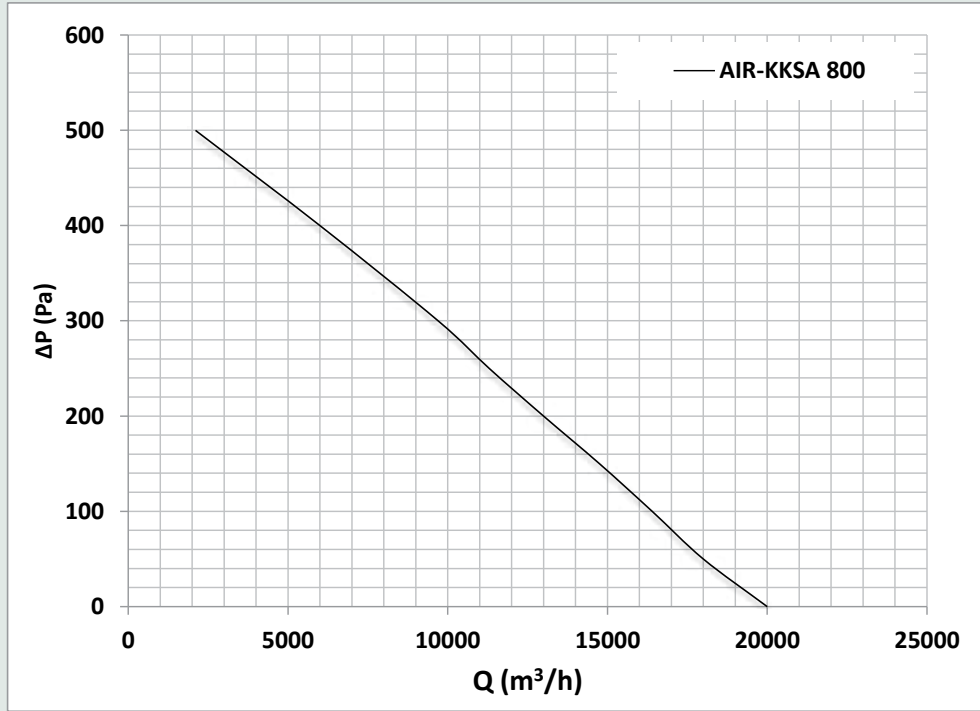

Wall Type Square Casing Industrial Ventilation Series

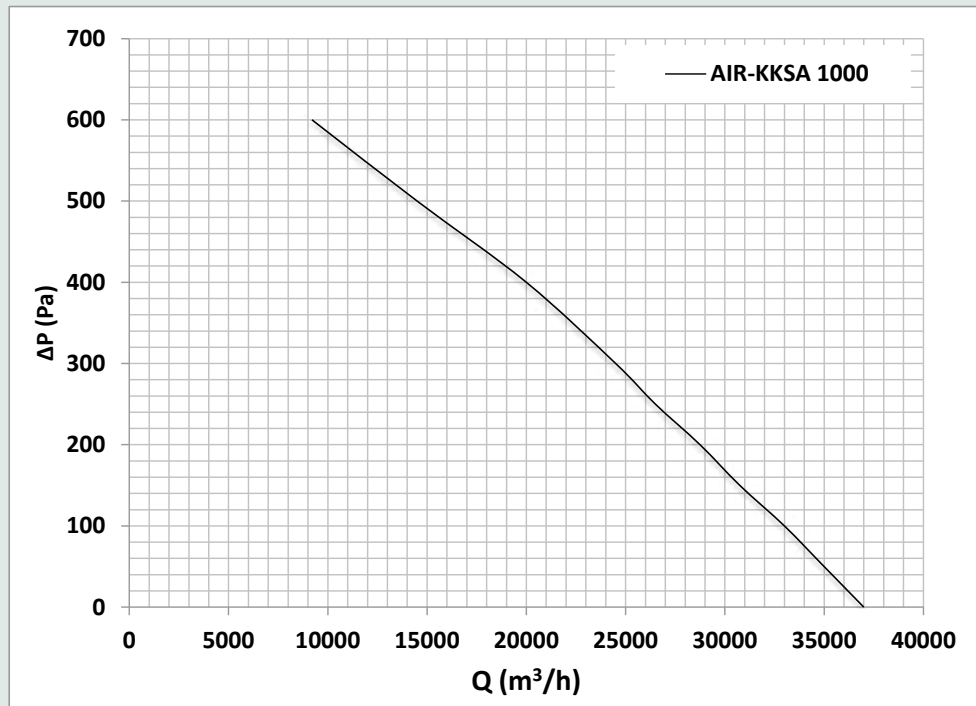

Wall Type Square Casing Industrial Ventilation Series

Aironn AIR-KSA Series fans are suitable to operate at maximum 55 °C. In order for you to make a selection to meet your need, 9 different models are available. They have axial fan blades.

Fan Body

They are made of electrostatic powder coated DKP sheet metal in square cages.

Fan Blades

Concave Fan Blade System with 6 Blades is made of DKP sheet metal. The wheels are statically and dynamically balanced in compliance with ISO 1940/1-2003.

Motor

B insulation class motor is inside the air flow.

Electricity

Electric switch box is not included.

Accessories

Speed Control Switch, Damper



Wall Type Square Casing Industrial Ventilation Series

Dimensions

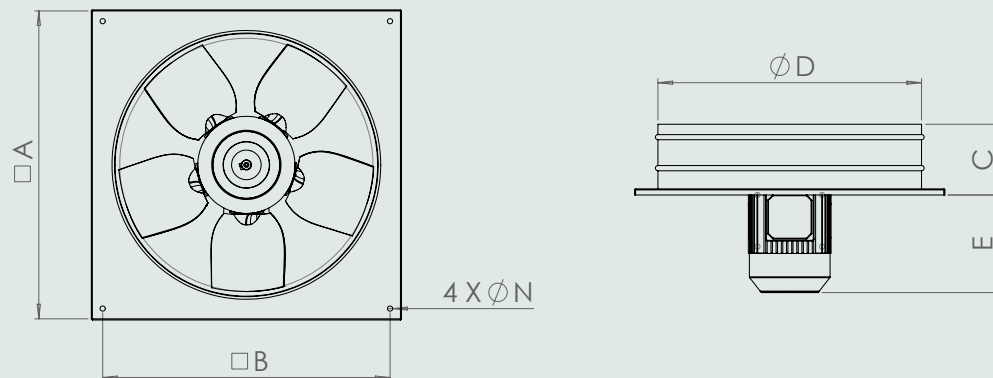

	A	B	C	D	E	Ø N
AIR-KSA 250	333	275	80	261	80	8
AIR-KSA 250 A	333	275	80	261	80	8
AIR-KSA 300	412	336	80	307	80	8
AIR-KSA 350	465	390	90	365	80	8
AIR-KSA 400	500	420	100	403	80	8
AIR-KSA 450	560	480	105	462	80	8
AIR-KSA 500	630	561	110	513	90	8
AIR-KSA 550	660	585	145	565	135	8
AIR-KSA 600	700	631	145	612	135	8

Tip	Voltage V	Frequency Hz	Motor Power W	Current A	Motor Speed d/d	Condenser µF	Noise dBA	Weight kg
AIR-KSA 250	230 / 380	50	195	0,87	2900	8	70	6,3
AIR-KSA 250 A	230 / 380	50	170	1,08	1465	8	52	6
AIR-KSA 300	230 / 380	50	210	12	1400	8	60	7
AIR-KSA 350	230 / 380	50	200	1,1	1400	8	58	8,2
AIR-KSA 400	230 / 380	50	230	1,2	1420	8	70	8,2
AIR-KSA 450	230 / 380	50	240	1,2	1385	8	70	9,6
AIR-KSA 500	230 / 380	50	245	1,2	1335	8	75	11
AIR-KSA 550	230 / 380	50	240	1	1350	10	70	15,3
AIR-KSA 600	230 / 380	50	235	1	1370	10	75	15,6

Wall Type Square Casing Industrial Ventilation Series

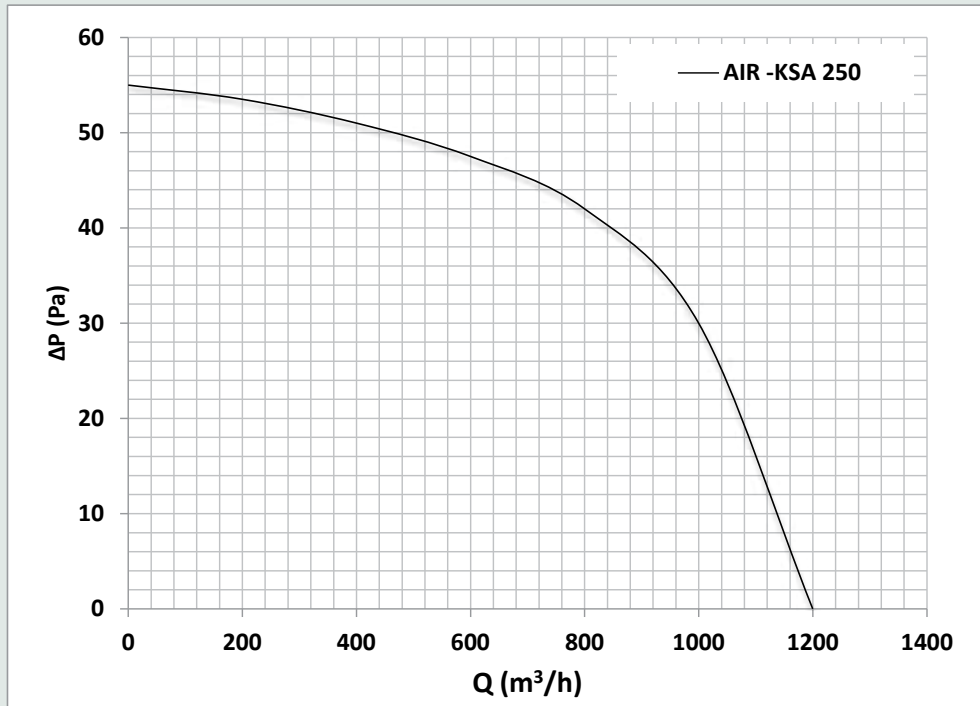
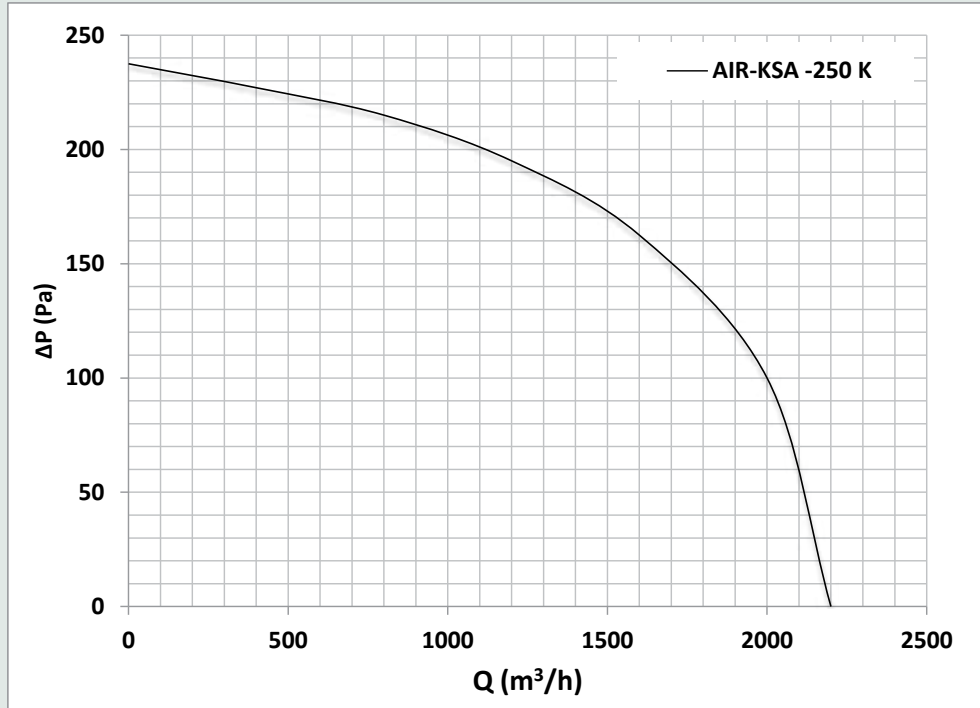

Wall Type Square Casing Industrial Ventilation Series

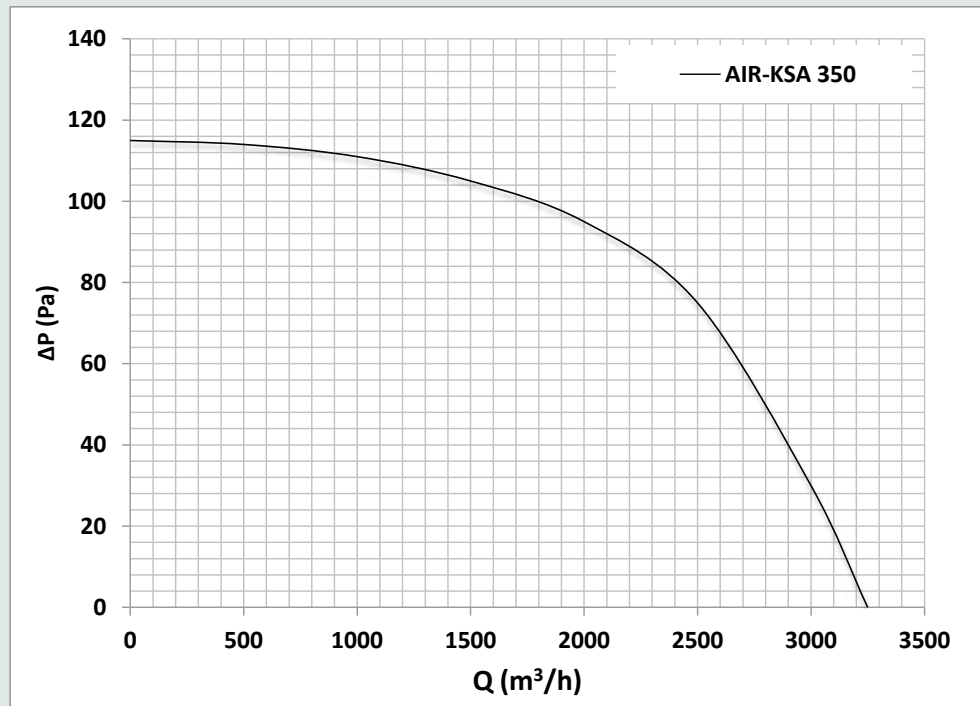
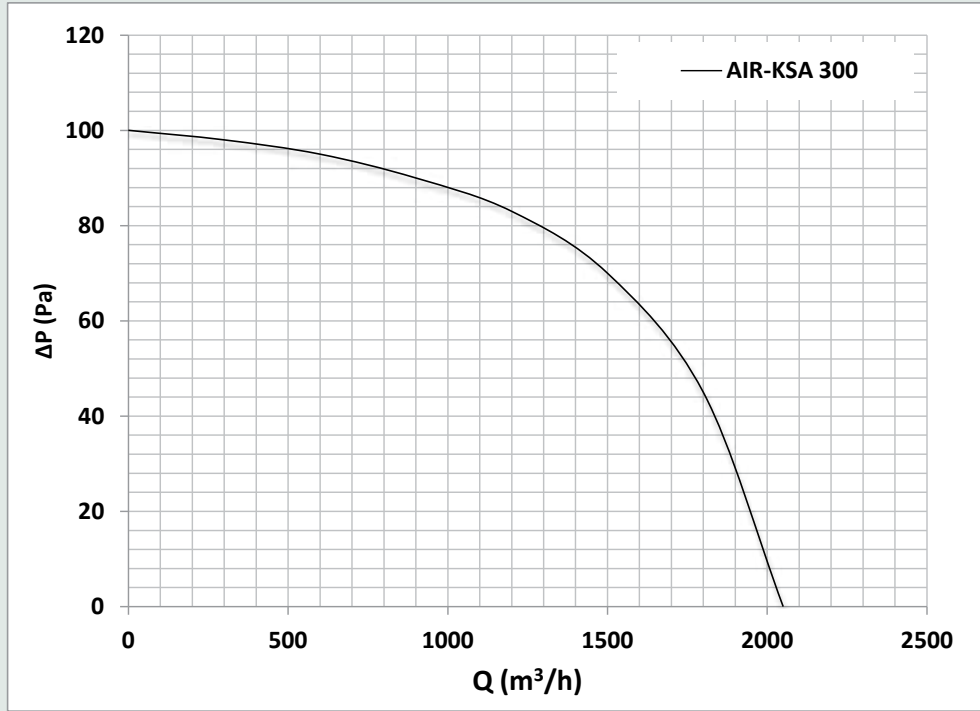

Wall Type Square Casing Industrial Ventilation Series

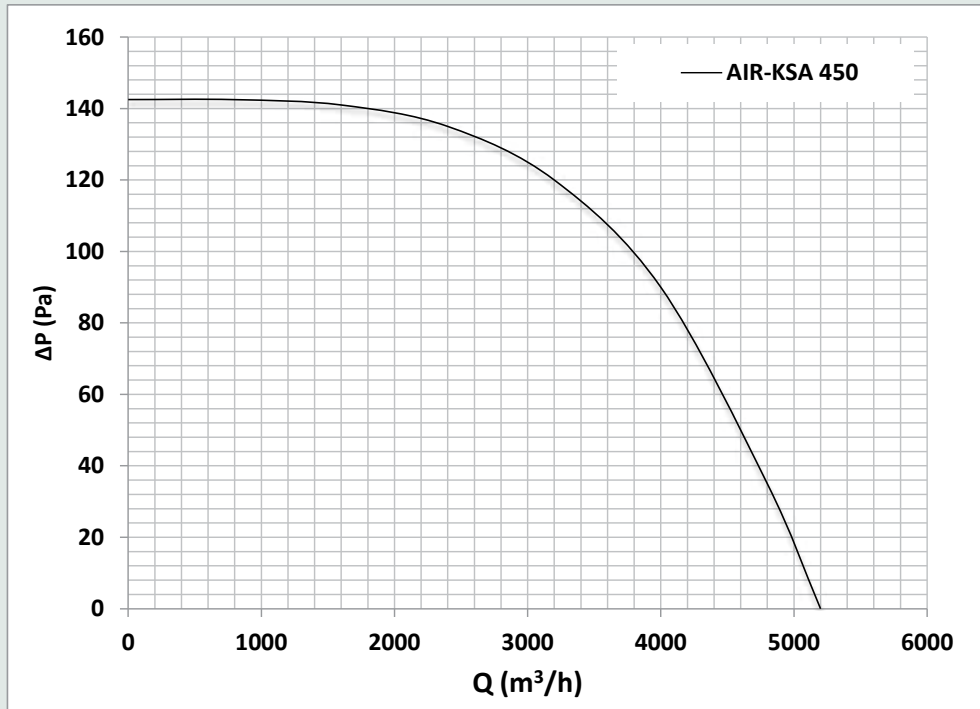
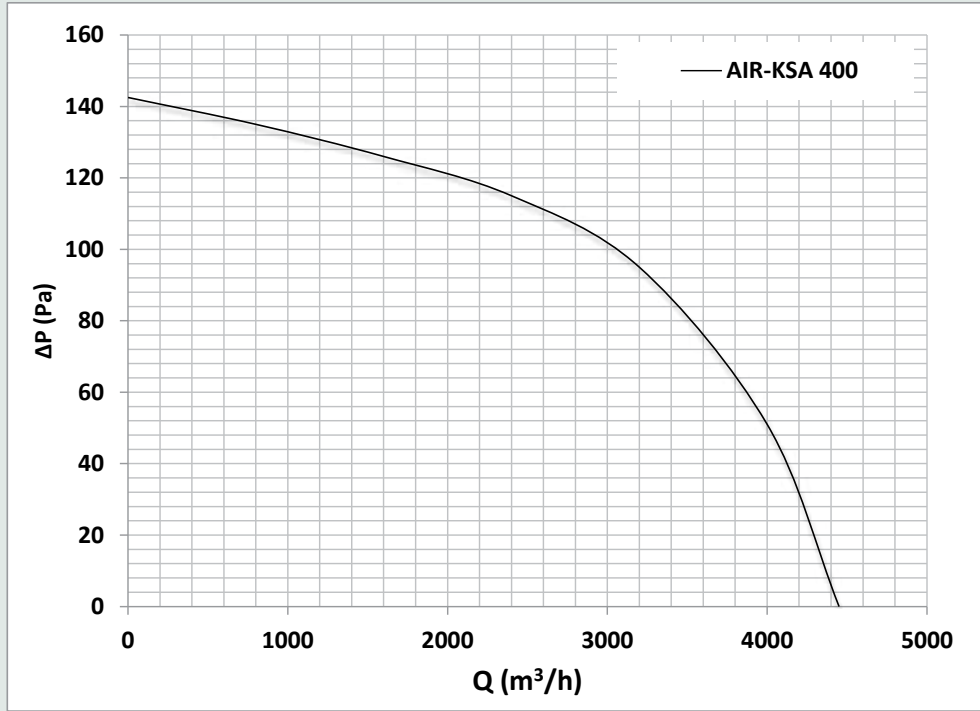

Wall Type Square Casing Industrial Ventilation Series

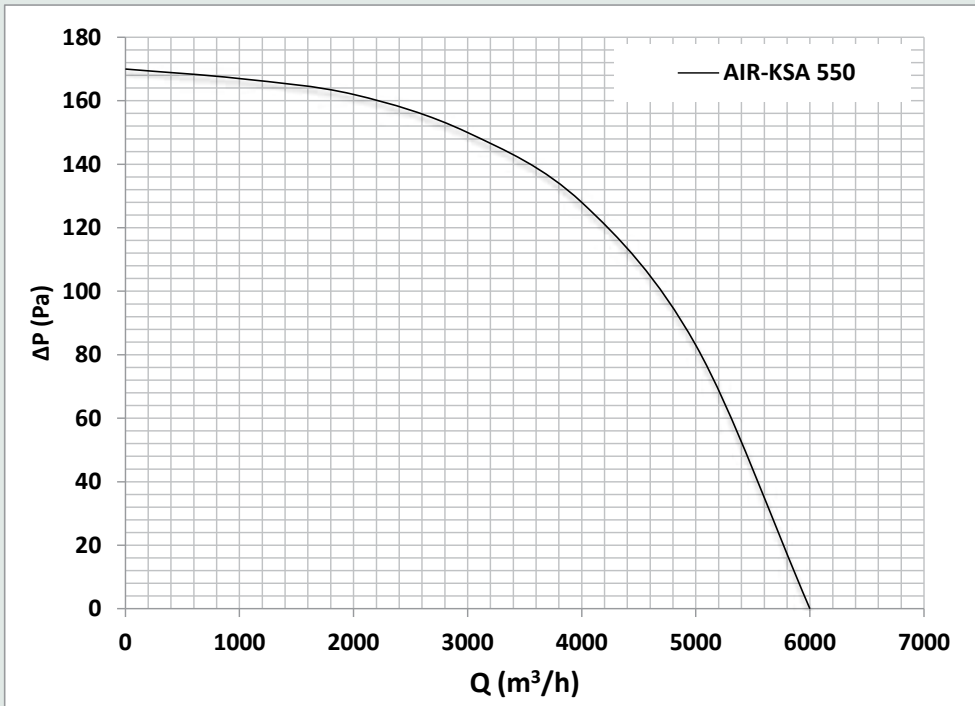
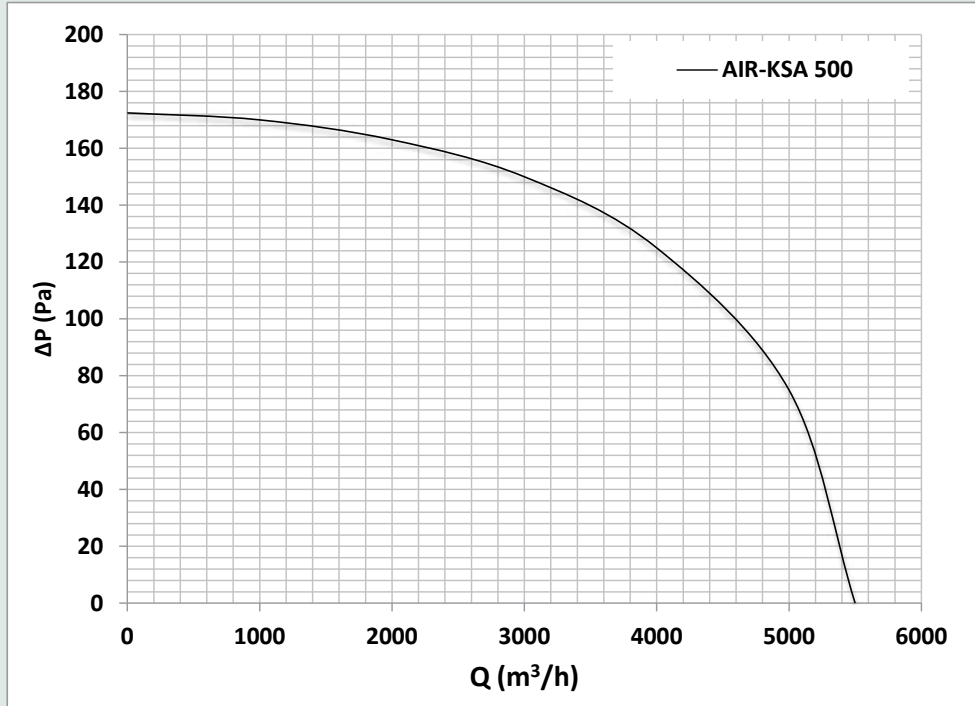

Wall Type Square Casing Industrial Ventilation Series

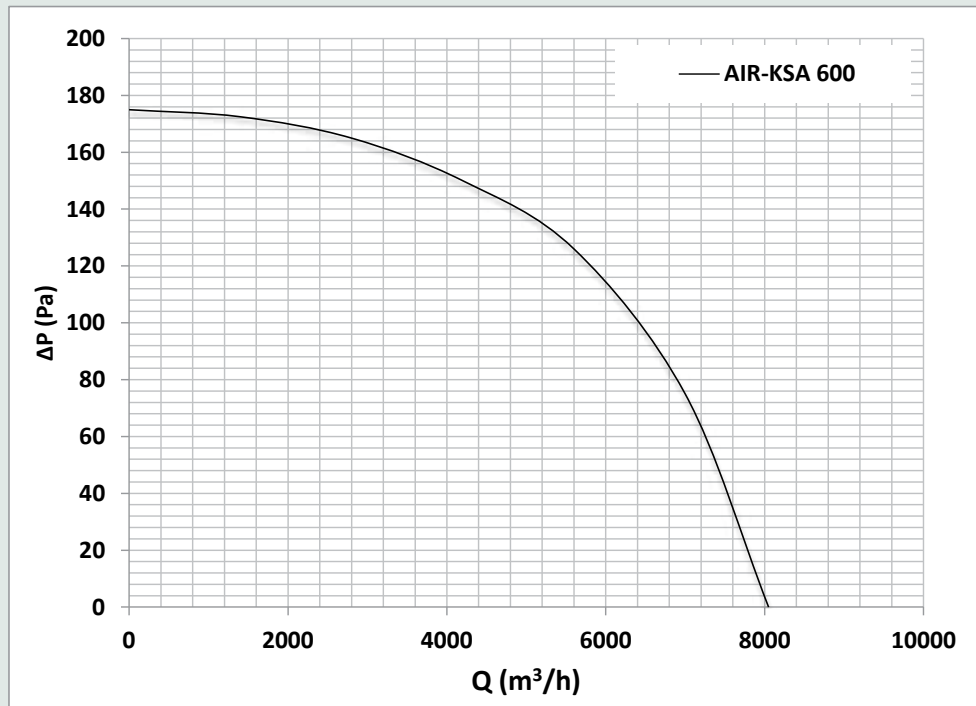





“FAN ENGINEERING”

AIRONN HAVALANDIRMA VE KLİMA SİSTEMLERİ SAN. DIŐ TİC. LTD. ŐTİ.

Tatlısu Mah. Őenol GneŐ Bulvarı Mira Tower K: 3 D: 16 Őerifali, AtaŐehir - İstanbul / Turkey

Phone: +90 216 594 56 96 Fax: +90 216 594 57 17 E-mail: info@aironn.com.tr

www.aironn.com.tr