



# Axial Smoke Exhaust and Fresh Air Fans



"FAN ENGINEERING"



# Axial Smoke Exhaust and Fresh Air Fans

# Contents

Axial Smoke Exhaust & Fresh Air Fan Series	2
Roof Type Axial (Horizontal) Smoke Exhaust & Fresh Air Fan Series	68
Roof Type Axial (Vertical) Smoke Exhaust & Fresh Air Fan Series	132
Cell Type Axial Smoke Exhaust & Fresh Air Fan Series	195
Series Type Axial Smoke Exhaust & Fresh Air Fan Series	260
Twin Spindle Axial Type Smoke Exhaust & Fresh Air Fan Series	324
Lobby Type Axial Smoke Exhaust & Fresh Air Fan Series for Roofs	388
Axial Type Silencer Body Smoke Exhaust & Fresh Air Fan	452

# Axial Smoke Exhaust Fan Series

Fans in the Aironn Axial Type Smoke Exhaust Fan series have 300 °C-2 hours and 400 °C-2 hours certificates in compliance with EN 12101-3. Adjustable edge angle of the series in the range of diameters between 400 mm and 1600 mm presents a broad performance range. It also provides an advantage by precisely ensuring the required flow. Performance of the fans in Axial Type Smoke Exhaust Fan Series have been tested in accordance with AMCA 210-07 standard.

## Fan Body

The body of the fans is made of high quality and corrosion resistant hot-dip galvanize coated sheet metal. The fan flanges are manufactured by bending the body so they are self flanged. Short and long body models of all fans are available. They are convenient for vertical or horizontal installation. Body inspection hatch is optional.

## Fan Blades

Aerodynamic fan blades are made of ETIAL 171 with injection moulding method. They are statically and dynamically balanced in compliance with ISO 1940/1-2003.

## Motor

IP 55 motors with class H insulation are available in single cycle or double cycle options. If requested, single cycle motors can be used with inverters.

## Electricity

IP 55 electric terminal box made of aluminium is standard.

## Accessories

Horizontal Mount Foot, Vertical Mount Foot, Silencer (50), Silencer (100), Silencer with Pod (100), Counter Flange, Back Draft Damper, Protection Grill, Spring Insulator, Inlet Cone, Flexible Coupling, Pacco (Package) Switch, Vibration Sensor, Inverter



# Axial Fresh Air Fan Series

Fans in Aironn Axial Type Fresh Air Fan Series are suitable to operate at maximum 55 °C. Adjustable edge angle of the series in the range of diameters between 400 mm and 1600 mm presents a broad performance range. It also provides an advantage by precisely ensuring the required flow. Performance of the fans in Roof Type Axial Smoke Exhaust Fan Series have been tested in accordance with AMCA 210-07 standard.

## Fan Body

The body of the fans is made of high quality and corrosion resistant hot-dip galvanize coated sheet metal. The fan flanges are manufactured by bending the body so they are self flanged. Short and long body models of all fans are available. They are convenient for vertical or horizontal installation. Body inspection hatch is optional.

## Fan Blades

Aerodynamic fan blades are made of ETIAL 171 with injection moulding method. They are statically and dynamically balanced in compliance with ISO 1940/1-2003.

## Motor

IP 55 motors with class F insulation are available in single cycle or double cycle options. If requested, single cycle motors can be used with inverters.

## Electricity

IP 55 electric terminal box made of plastic is standard.

## Accessories

Horizontal Mount Foot, Vertical Mount Foot, Silencer (50), Silencer (100), Silencer with Pod (100), Counter Flange, Back Draft Damper, Protection Grill, Spring Insulator, Inlet Cone, Flexible Coupling, Pacco (Package) Switch, Vibration Sensor, Inverter



## Long Body Axial Smoke Exhaust & Fresh Air Fan Series

### Dimensions

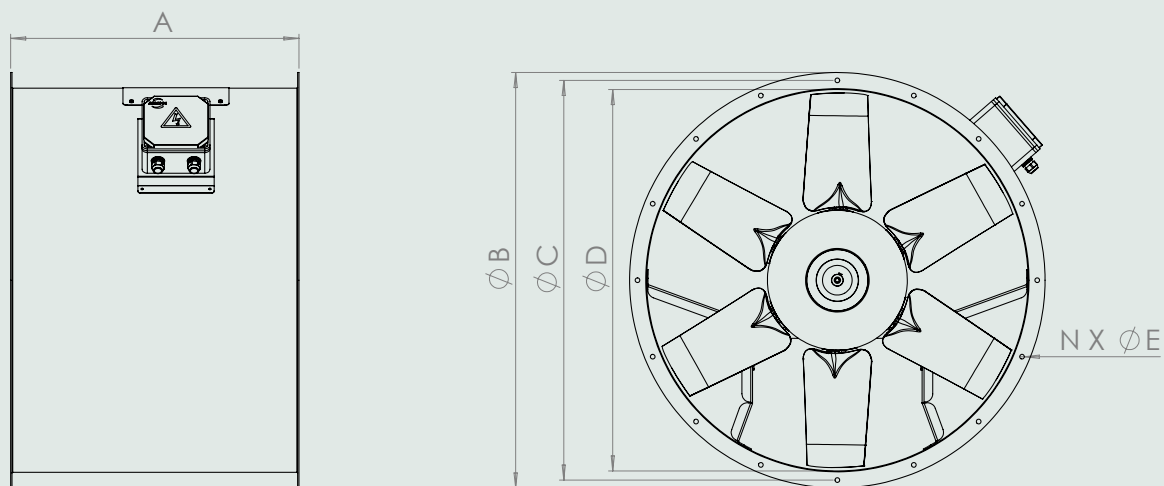

	A	B	C	D	N X Ø E
400	420	460	430	400	8 x 11
450	420	510	484	450	8 x 11
500	420	560	537	500	8 x 11
560	420	620	597	560	8 x 11
630	470	590	667	630	8 x 11
710	500	770	747	710	8 x 11
800	580	880	844	800	16 x 11
900	700	980	944	900	16 x 13
1000	775	1080	1044	1000	16 x 13
1250	775	1330	1294	1250	16 x 13

## Short Body Axial Smoke Exhaust & Fresh Air Fan Series

### Dimensions

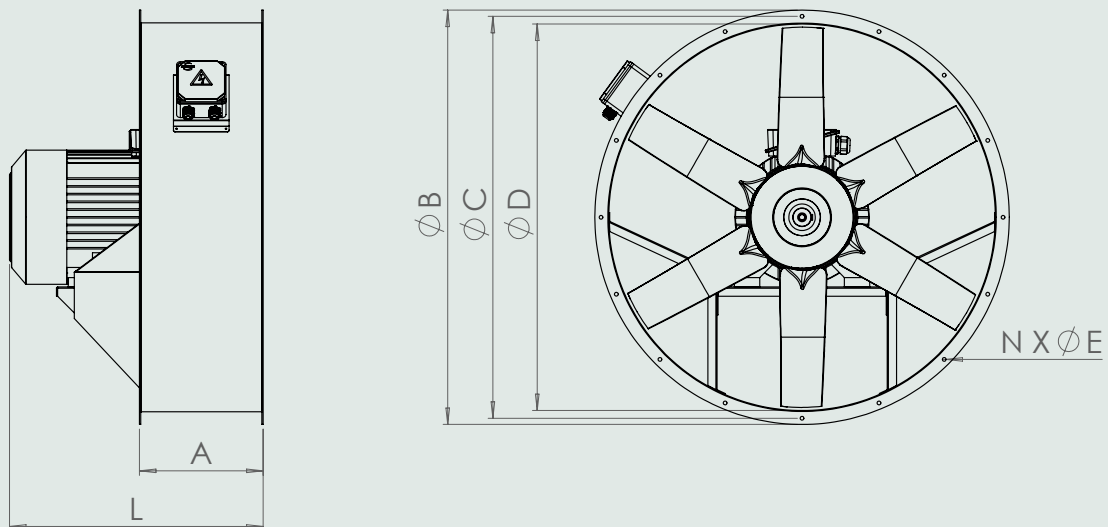

	A	B	C	D	Lmax	N X Ø E
400	400	460	430	400	420	8 x 11
450	400	510	484	450	420	8 x 11
500	400	560	537	500	420	8 x 11
560	400	620	597	560	420	8 x 11
630	400	590	667	630	470	8 x 11
710	400	770	747	710	500	8 x 11
800	400	880	844	800	580	16 x 11
900	400	980	944	900	700	16 x 13
1000	400	1080	1044	1000	775	16 x 13
1250	400	1330	1294	1250	775	16 x 13

# Long Body Vertical Axial Smoke Exhaust & Fresh Air Fan Series

## Dimensions

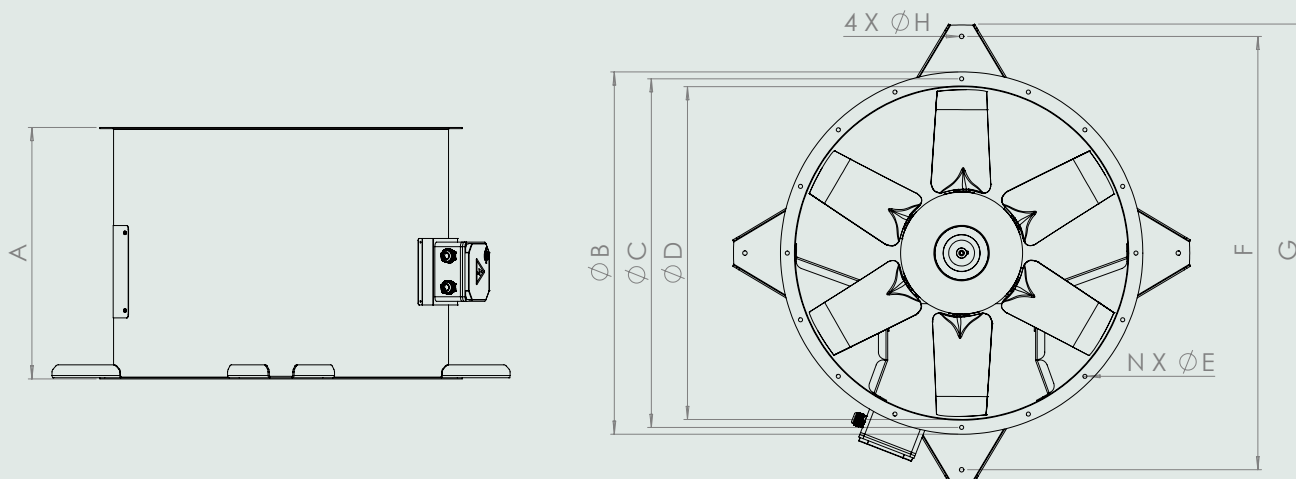

	A	B	C	D	F	G	H	N X Ø E
400	420	460	430	400	573	632	11	8 x 11
450	420	510	484	450	628	687	11	8 x 11
500	420	560	537	500	782	830	12	8 x 11
560	420	620	597	560	842	890	12	8 x 11
630	470	590	667	630	908	956	12	8 x 11
710	500	770	747	710	994	1042	12	8 x 11
800	580	880	844	800	1077	1132	12	16 x 11
900	700	980	944	900	1172	1234	12	16 x 13
1000	775	1080	1044	1000	1284	1334	12	16 x 13
1250	775	1330	1294	1250	1552	1620	12	16 x 13



# Long Body Horizontal Axial Smoke Exhaust & Fresh Air Fan Series

## Dimensions

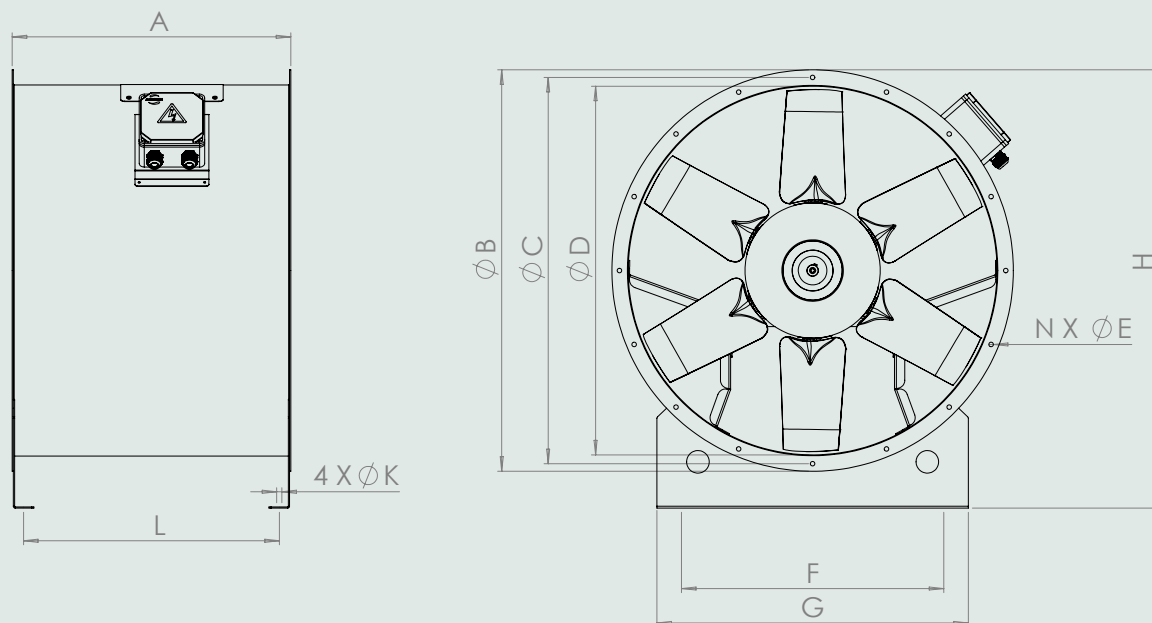

	A	B	C	D	F	G	L	H	N X Ø E	Ø K
400	420	460	430	400	300	360	378	500	8 x 11	11
450	420	510	484	450	320	400	378	550	8 x 11	11
500	420	560	537	500	370	450	378	600	8 x 11	11
560	420	620	597	560	420	500	378	670	8 x 11	11
630	470	590	667	630	460	540	428	790	8 x 11	11
710	500	770	747	710	500	600	458	870	8 x 11	11
800	580	880	844	800	580	680	538	970	16 x 11	11
900	700	980	944	900	660	760	644	1070	16 x 13	13
1000	775	1080	1044	1000	750	850	717	1167	16 x 13	13
1250	775	1330	1294	1250	960	1060	717	1417	16 x 13	13

# Axial Hollow Fresh Air Fan Series

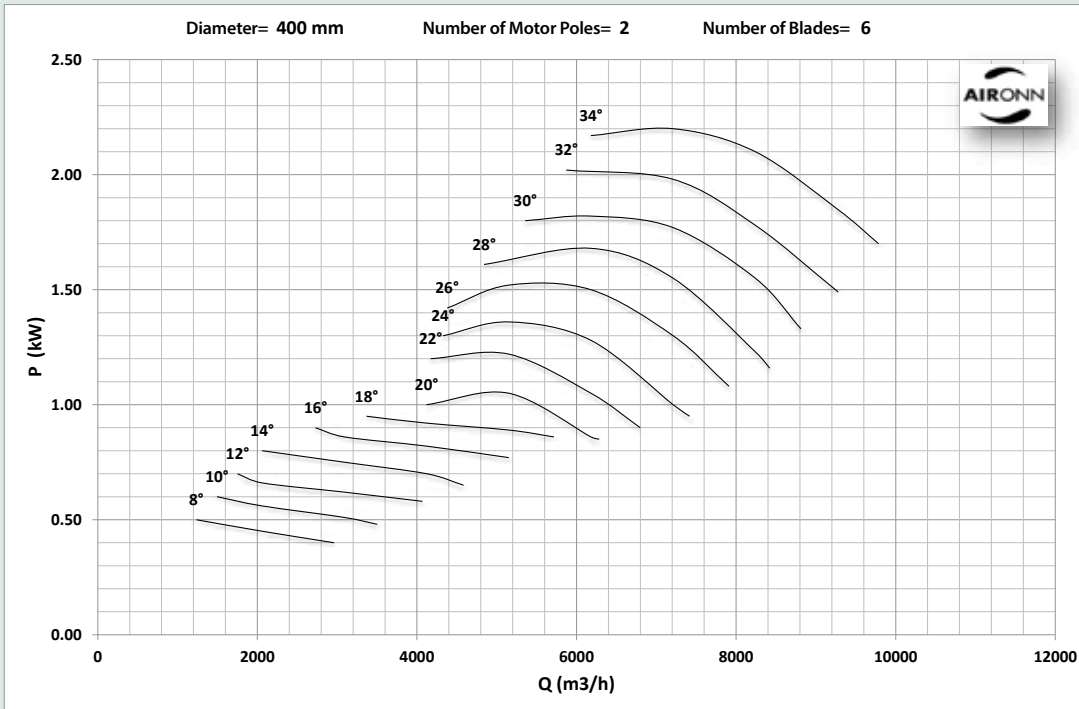
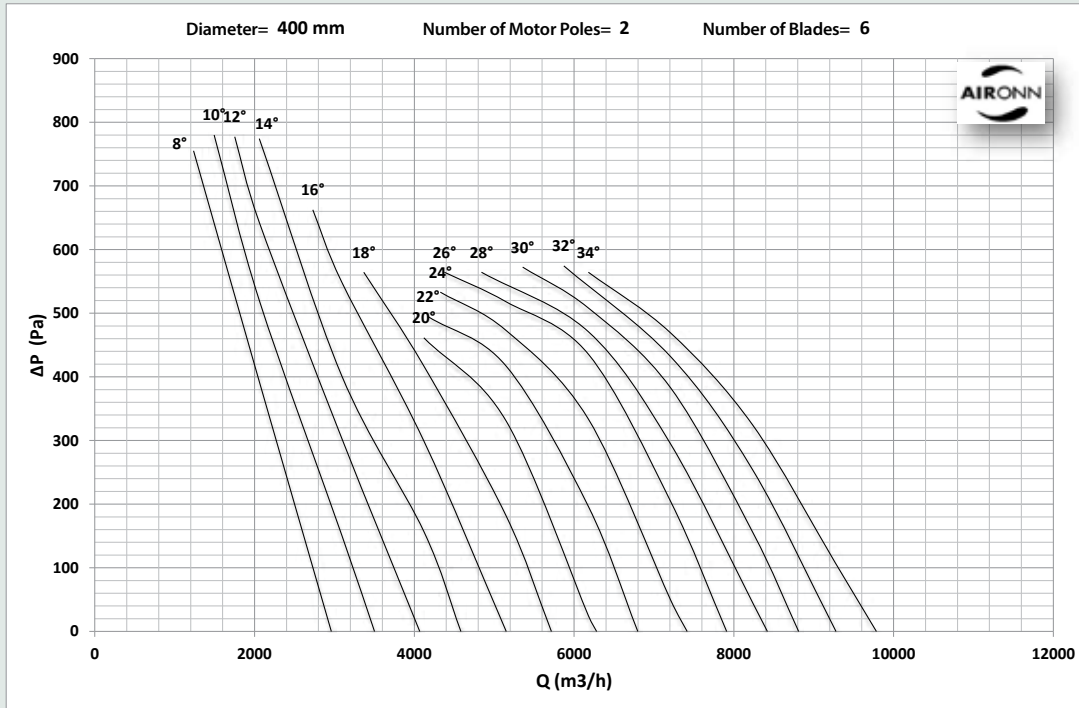

## Axial Hollow Fresh Air Fan Series

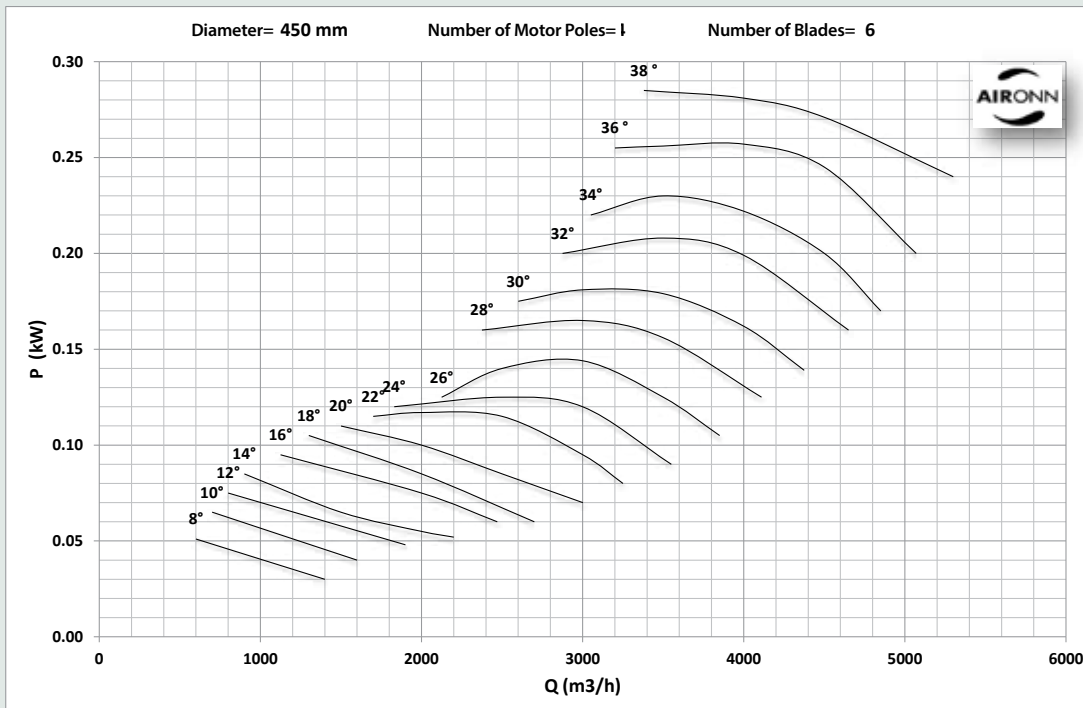
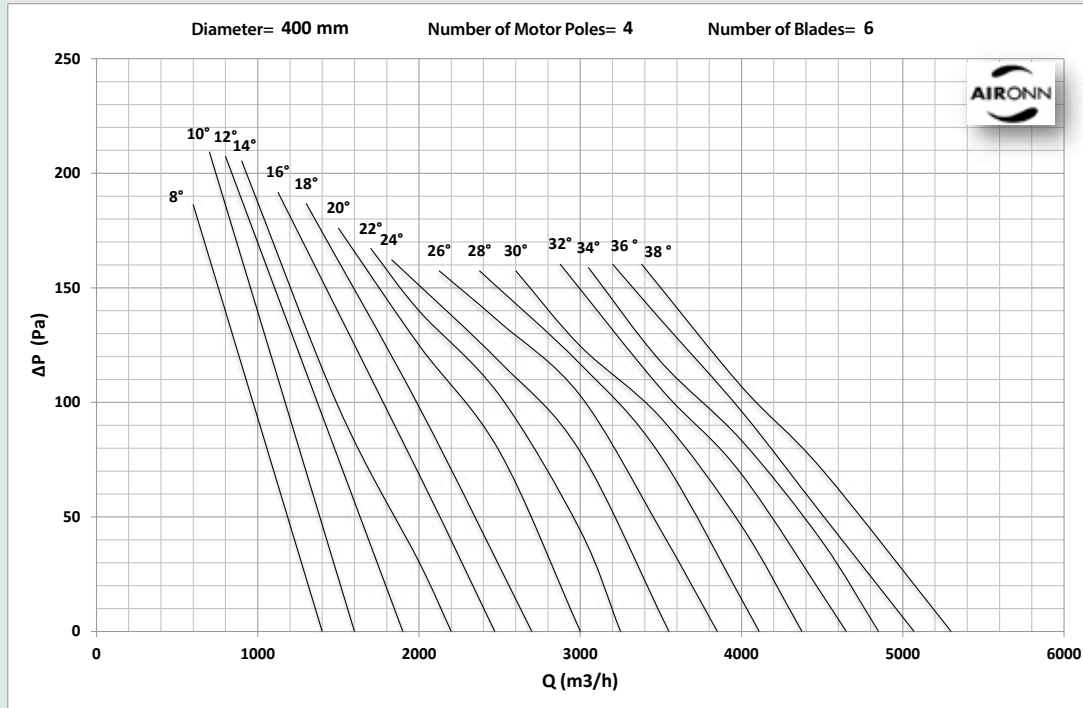

# Axial Hollow Fresh Air Fan Series

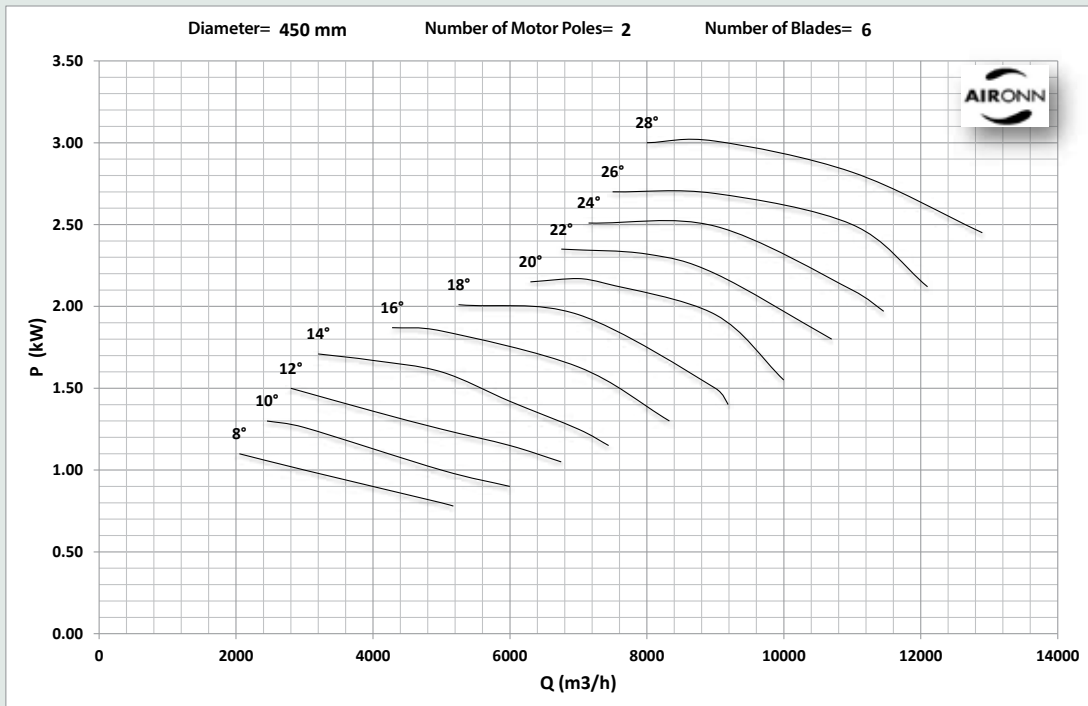
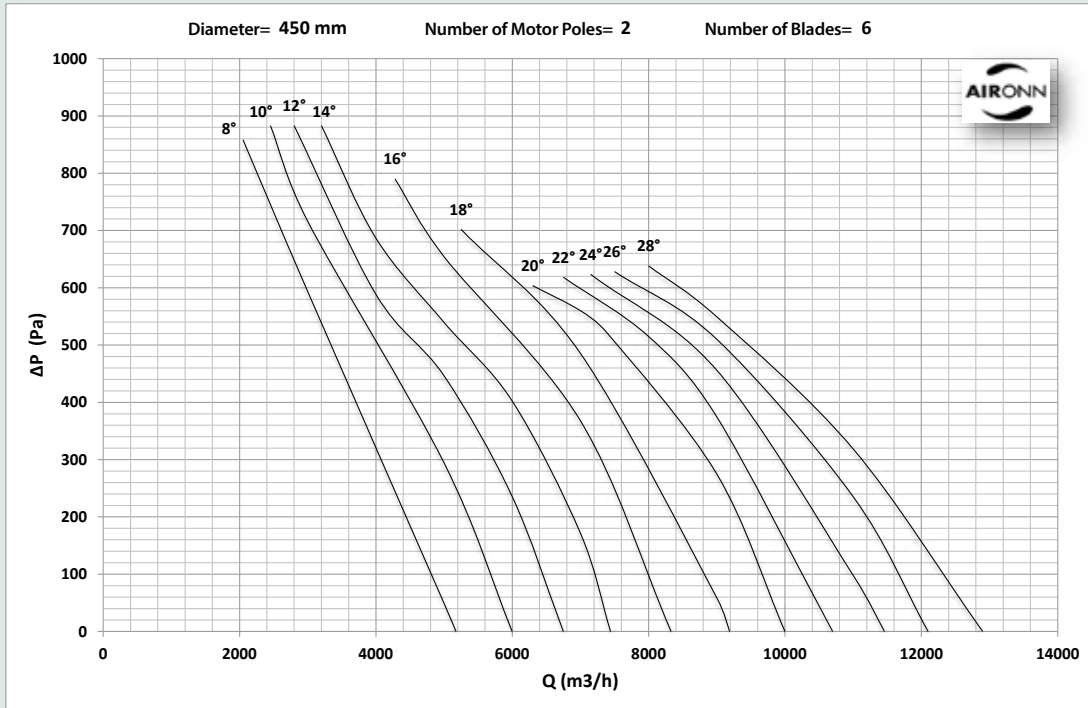

# Axial Hollow Fresh Air Fan Series

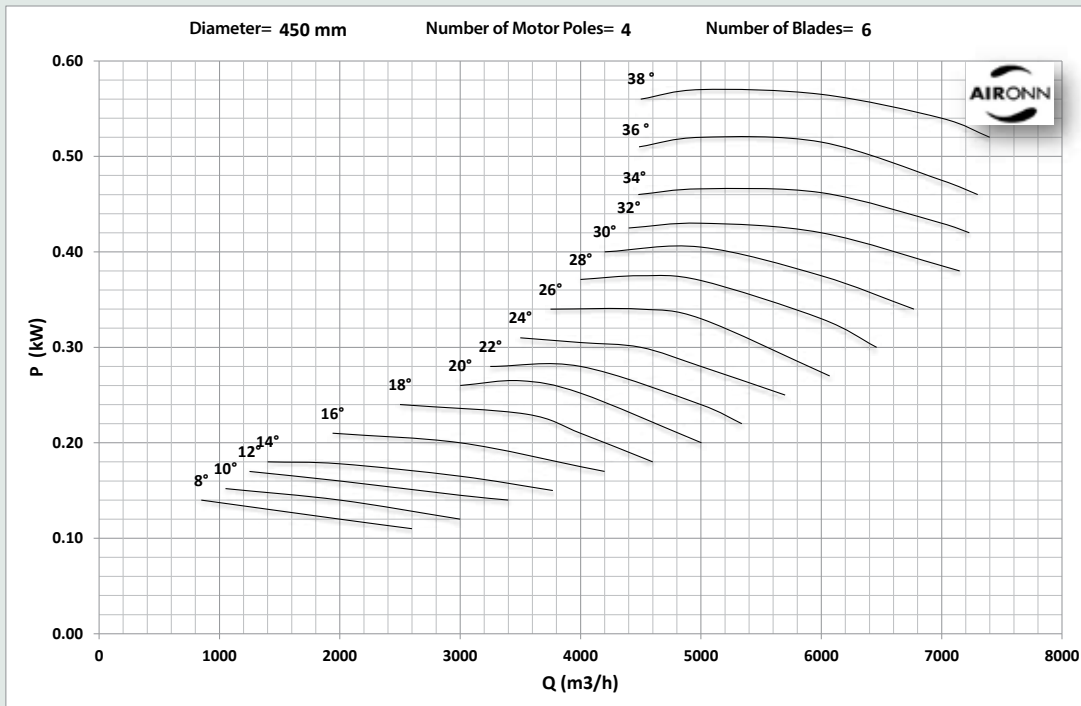
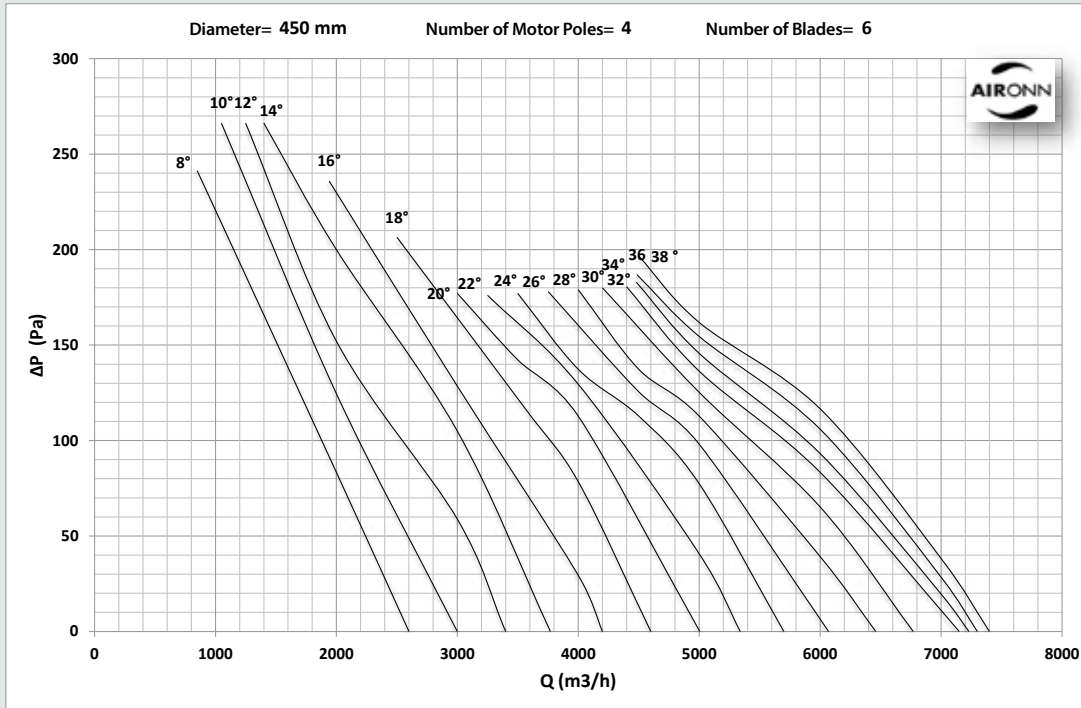

# Axial Hollow Fresh Air Fan Series

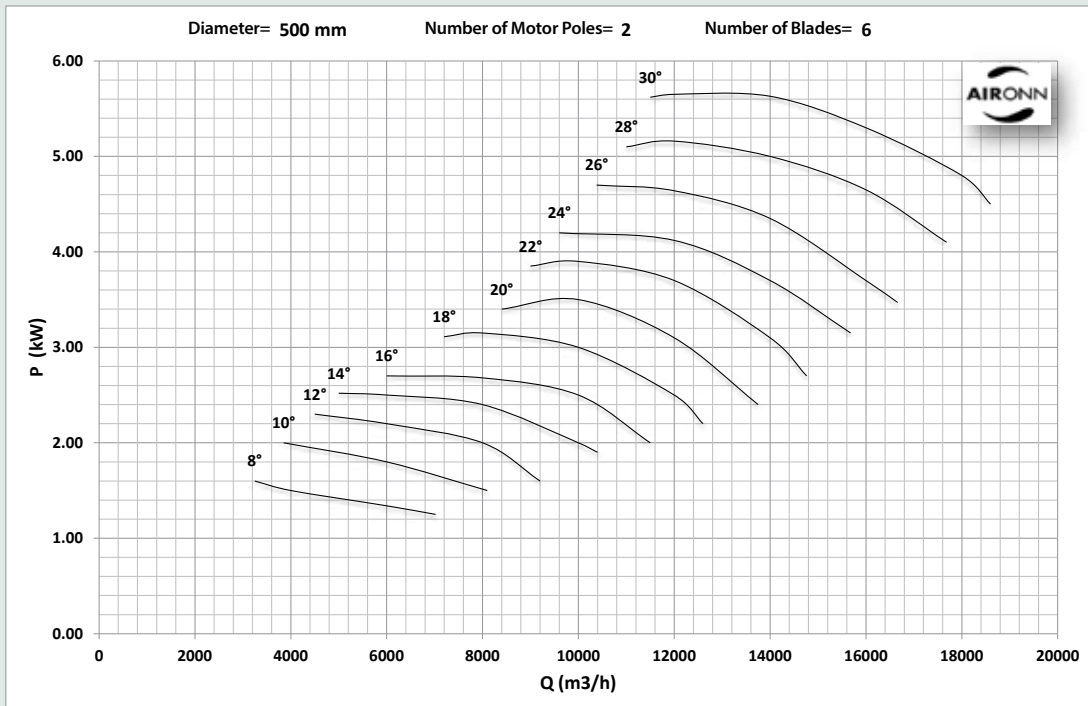
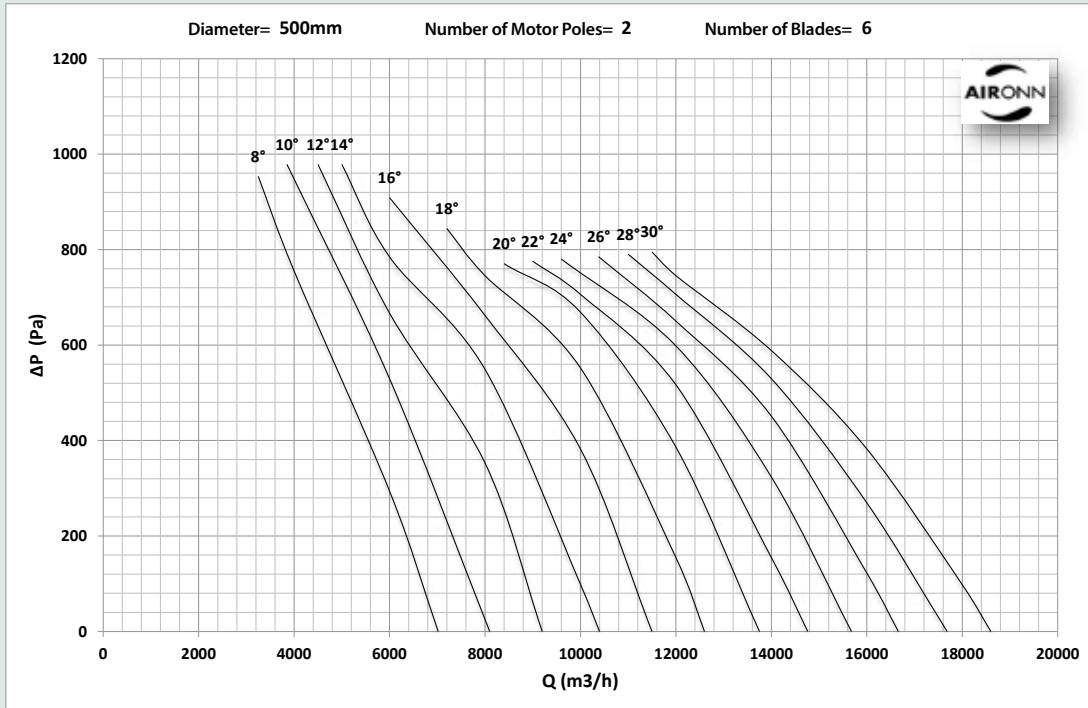

# Axial Hollow Fresh Air Fan Series

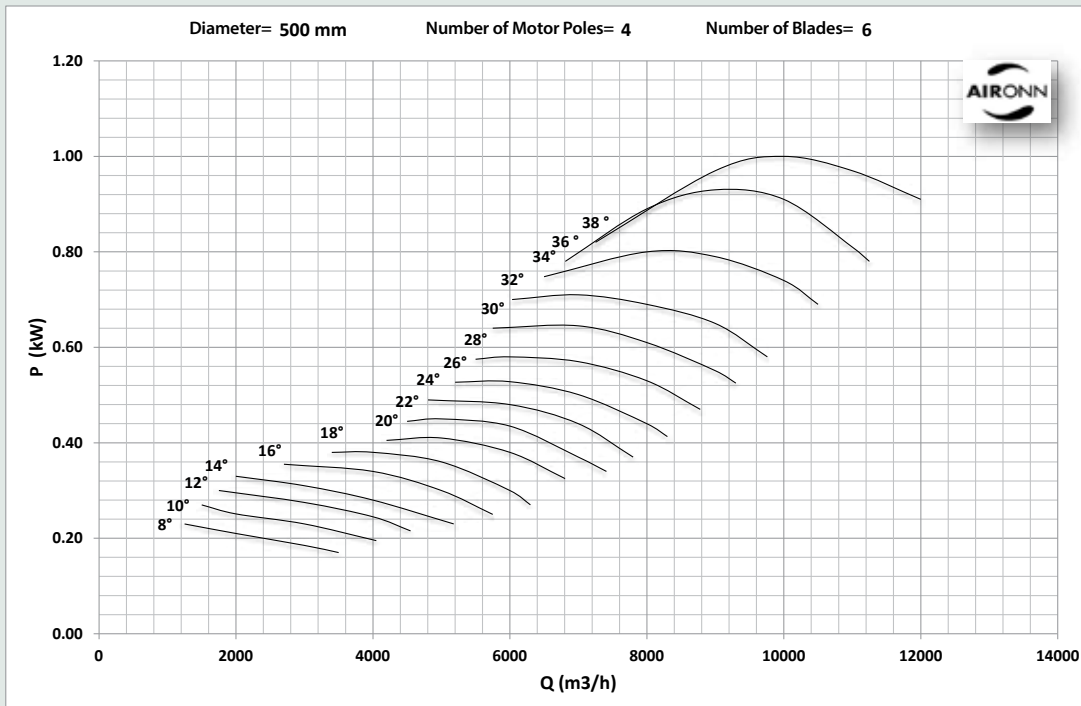
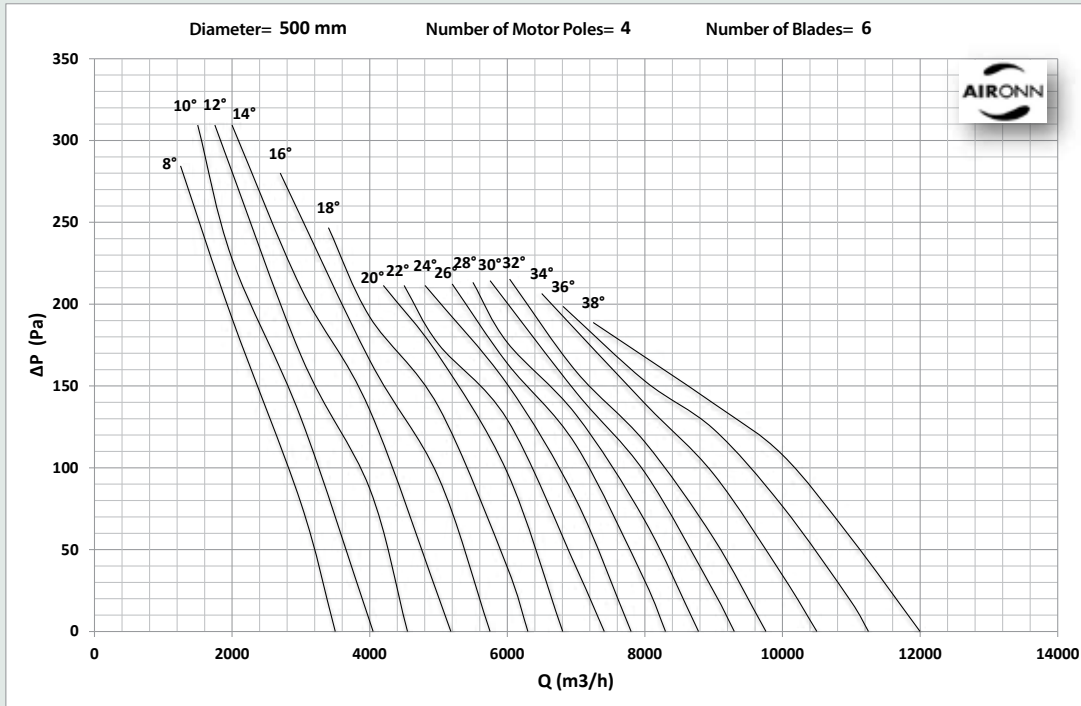

## Axial Hollow Fresh Air Fan Series

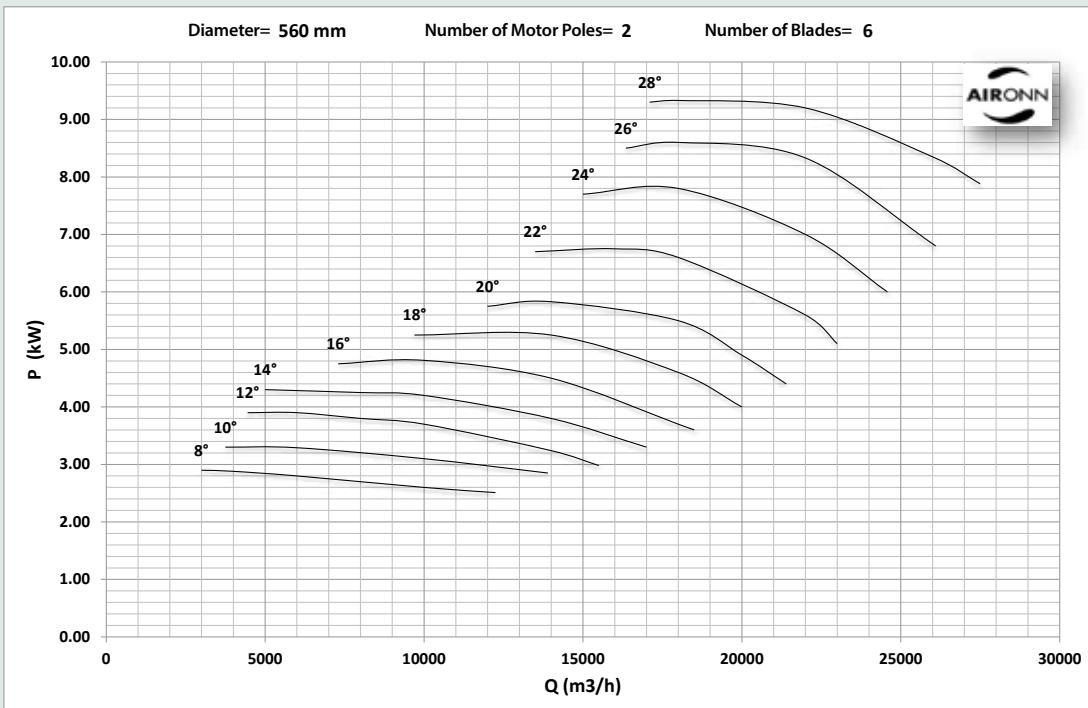
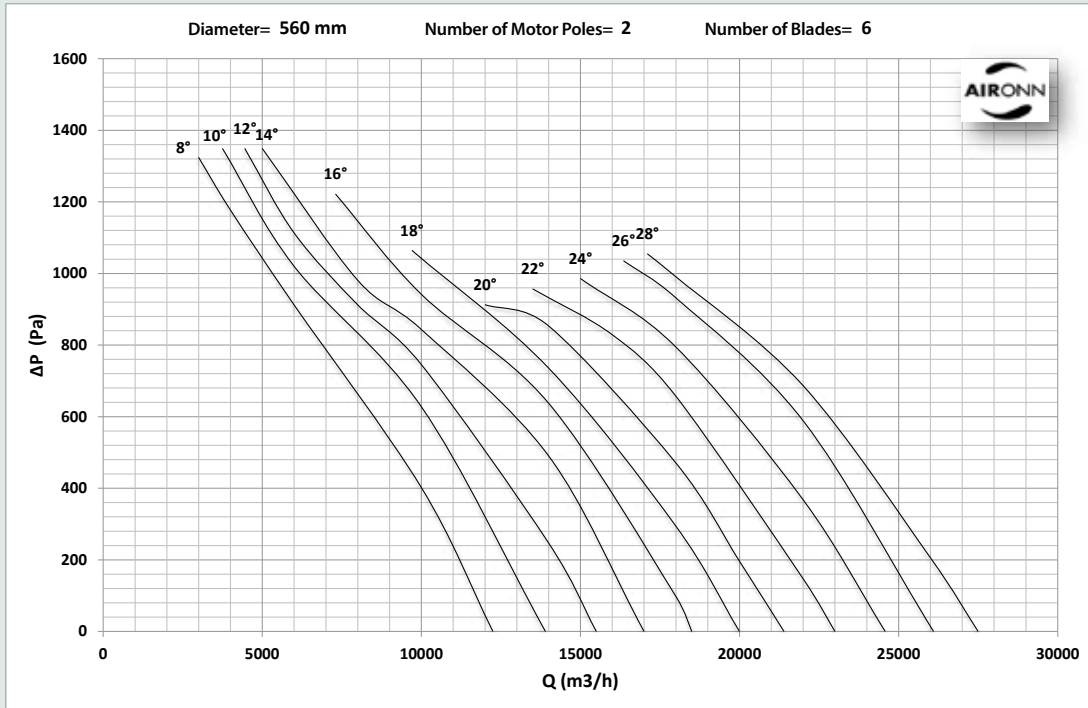



# Axial Hollow Fresh Air Fan Series

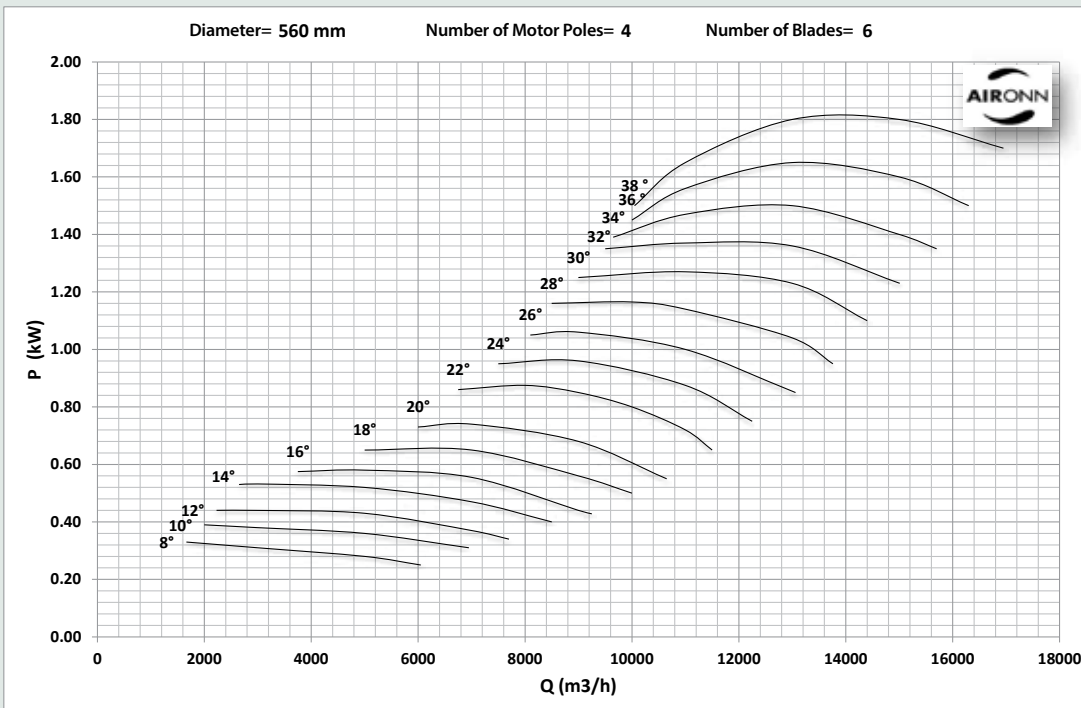
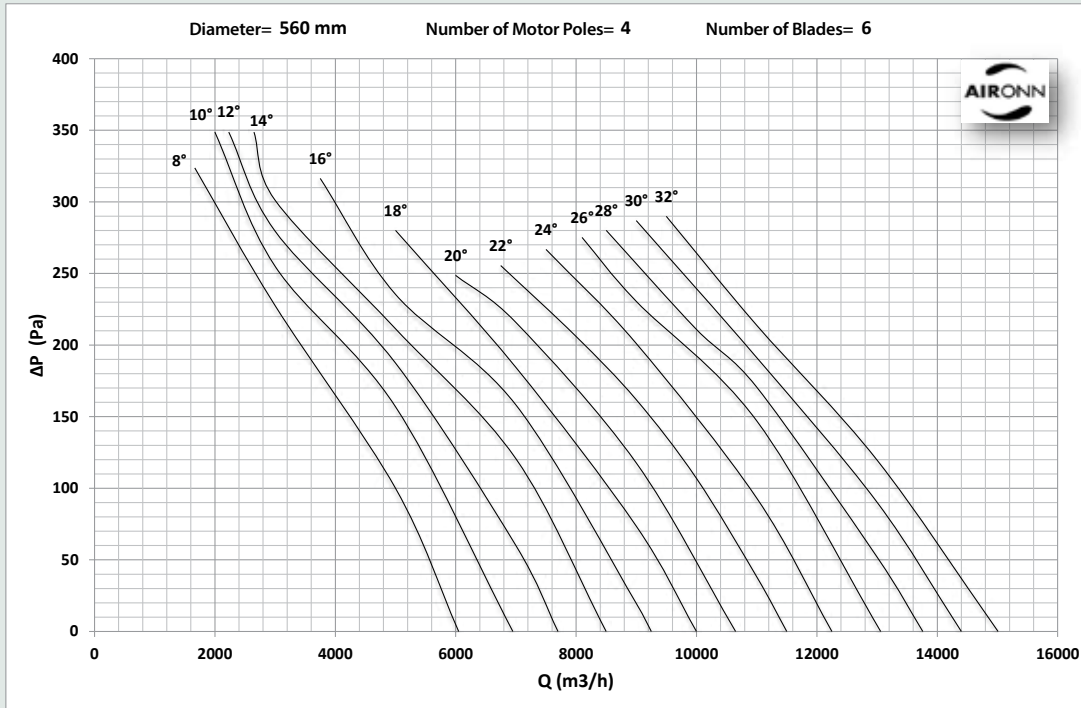

## Axial Hollow Fresh Air Fan Series

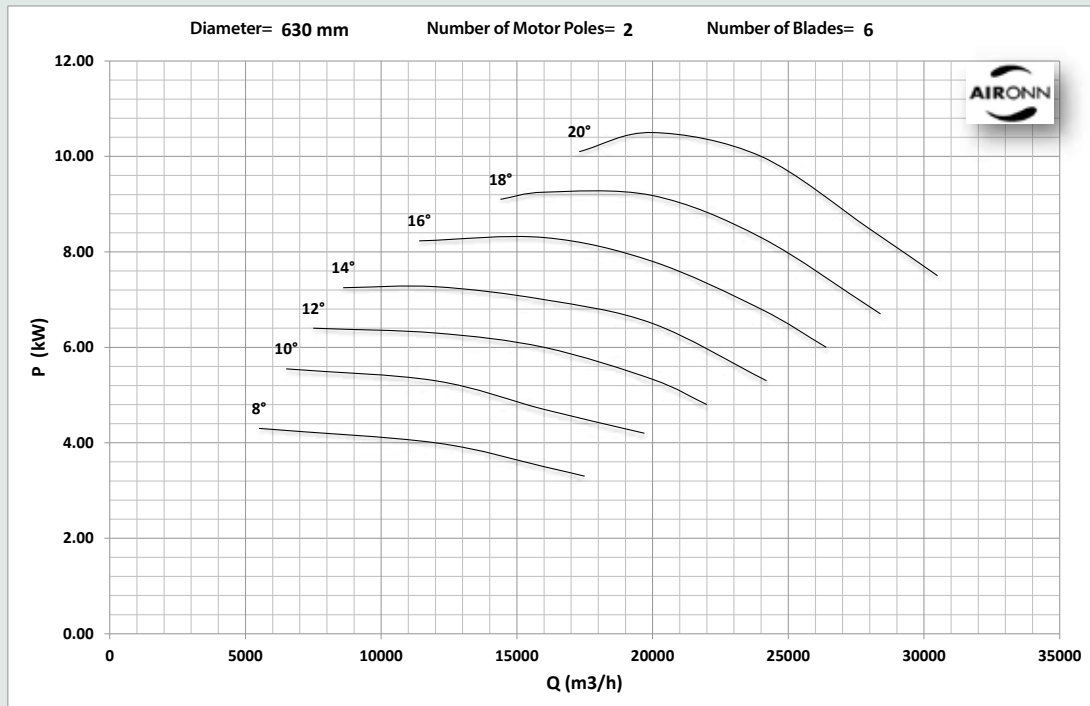
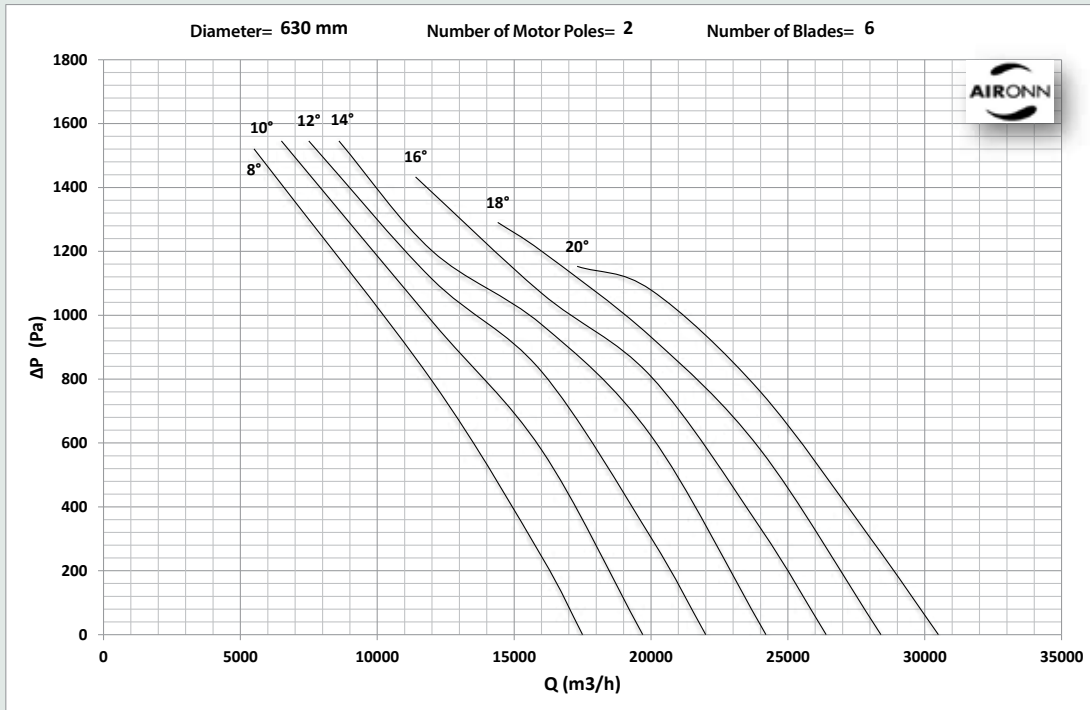

# Axial Hollow Fresh Air Fan Series

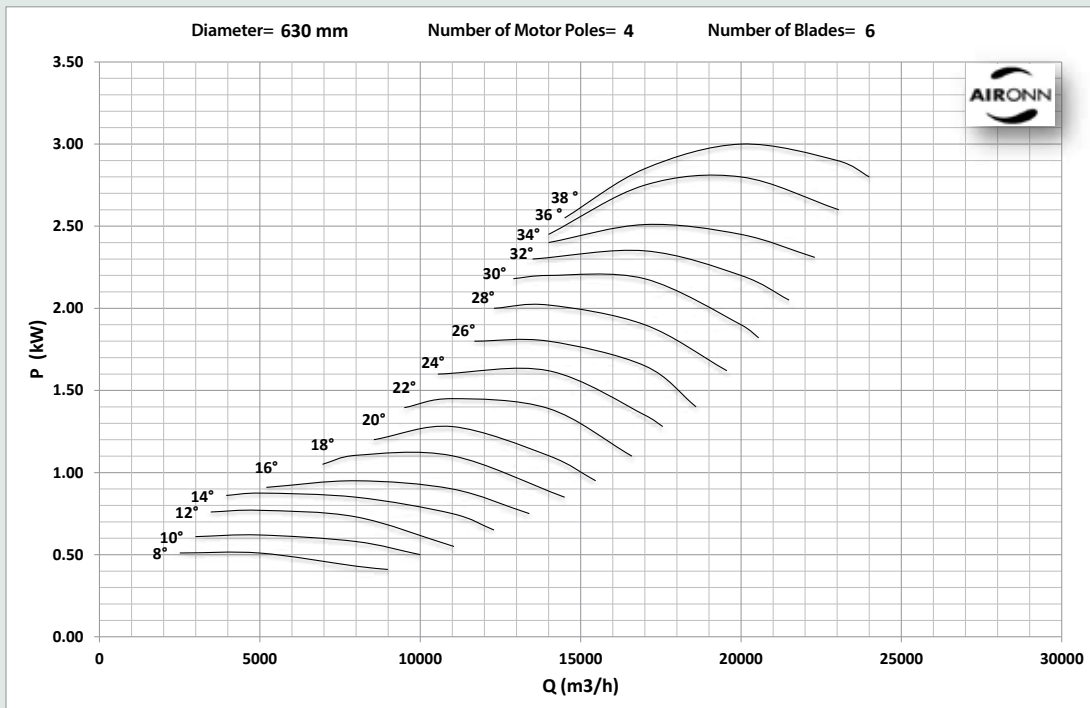
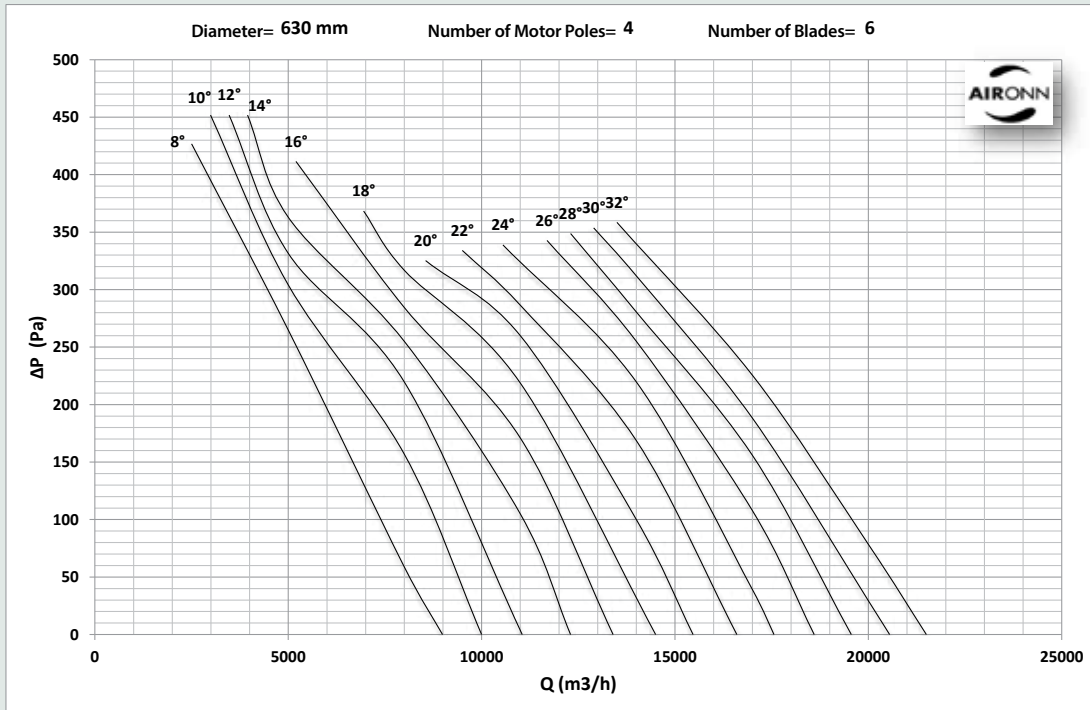

# Axial Hollow Fresh Air Fan Series

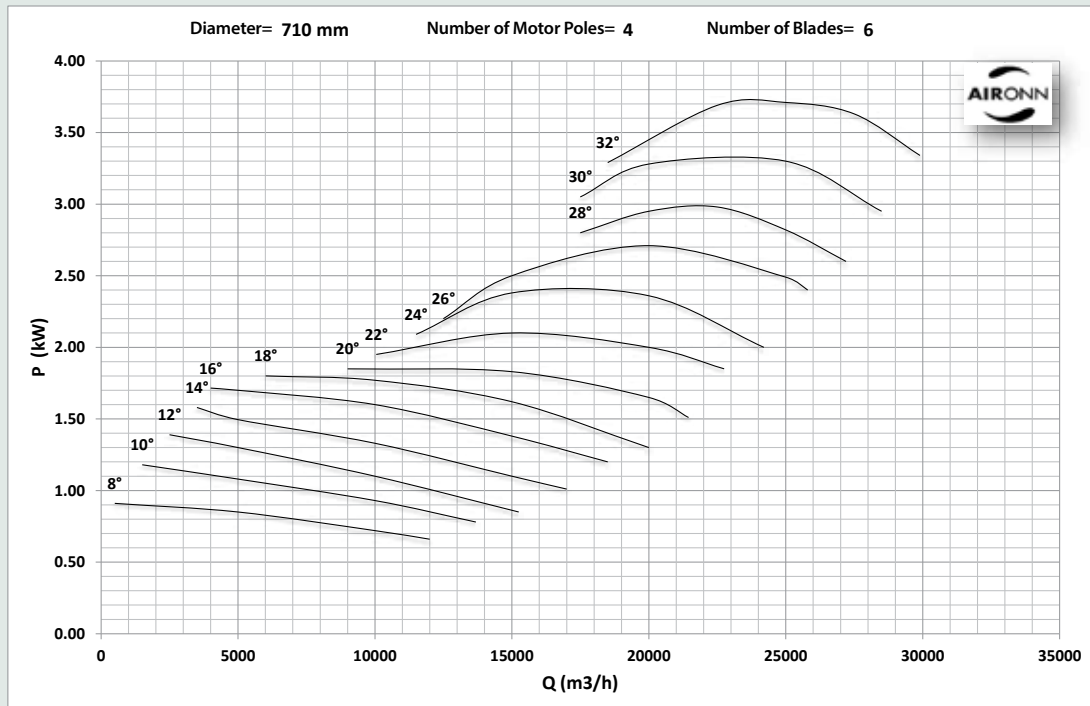
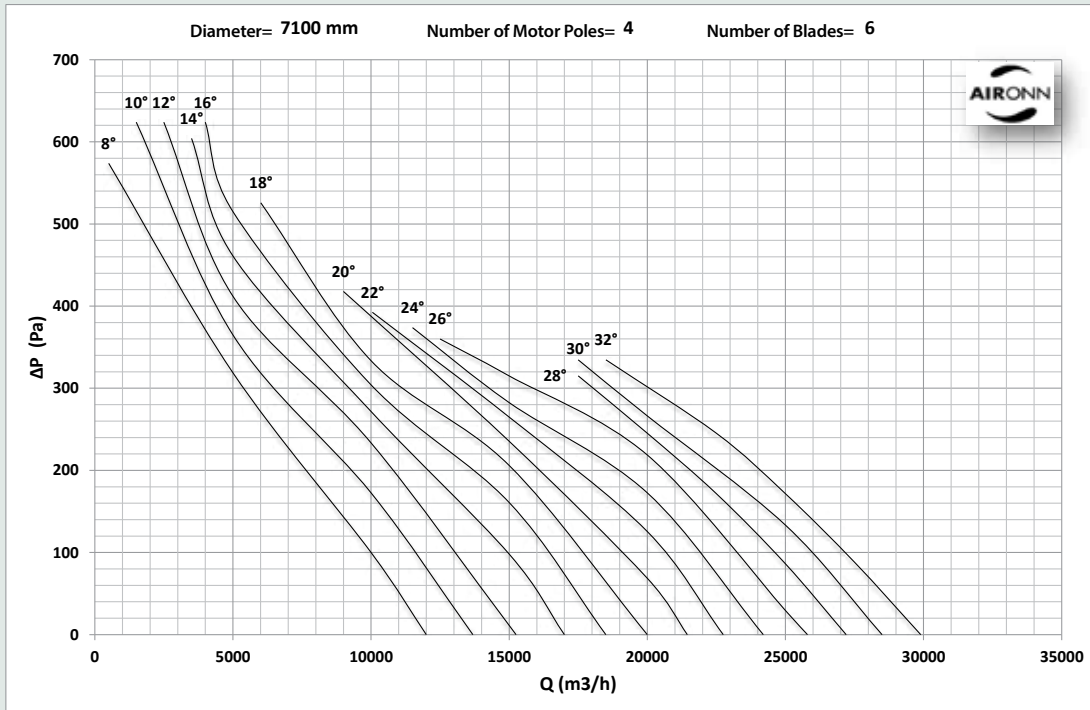

# Axial Hollow Fresh Air Fan Series

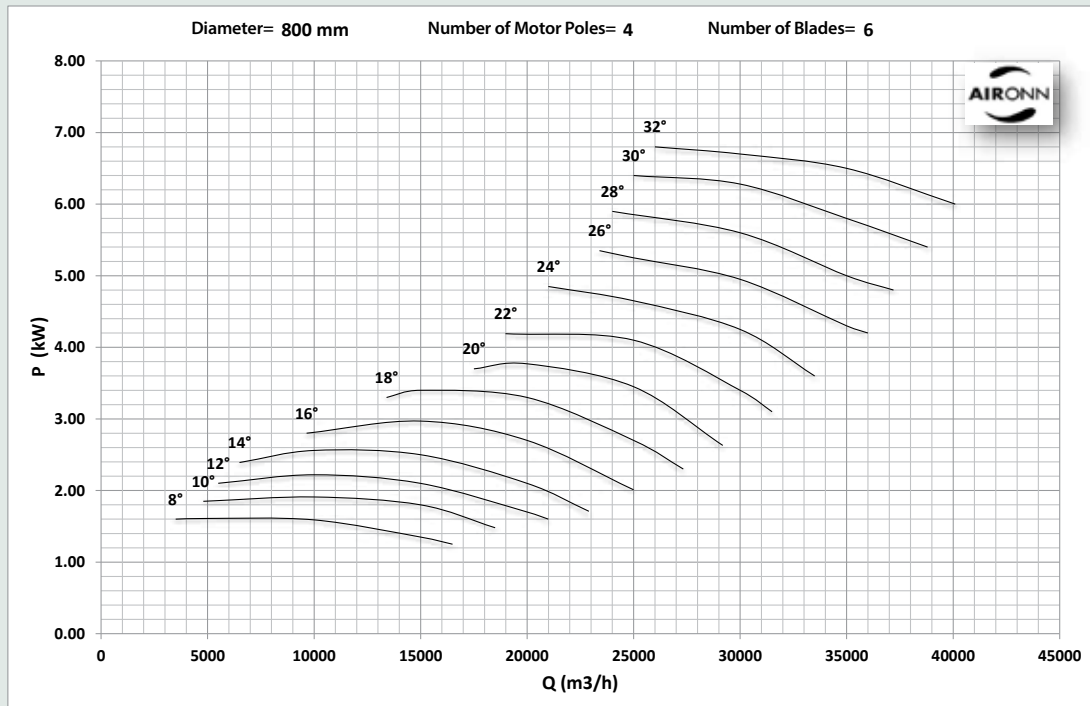
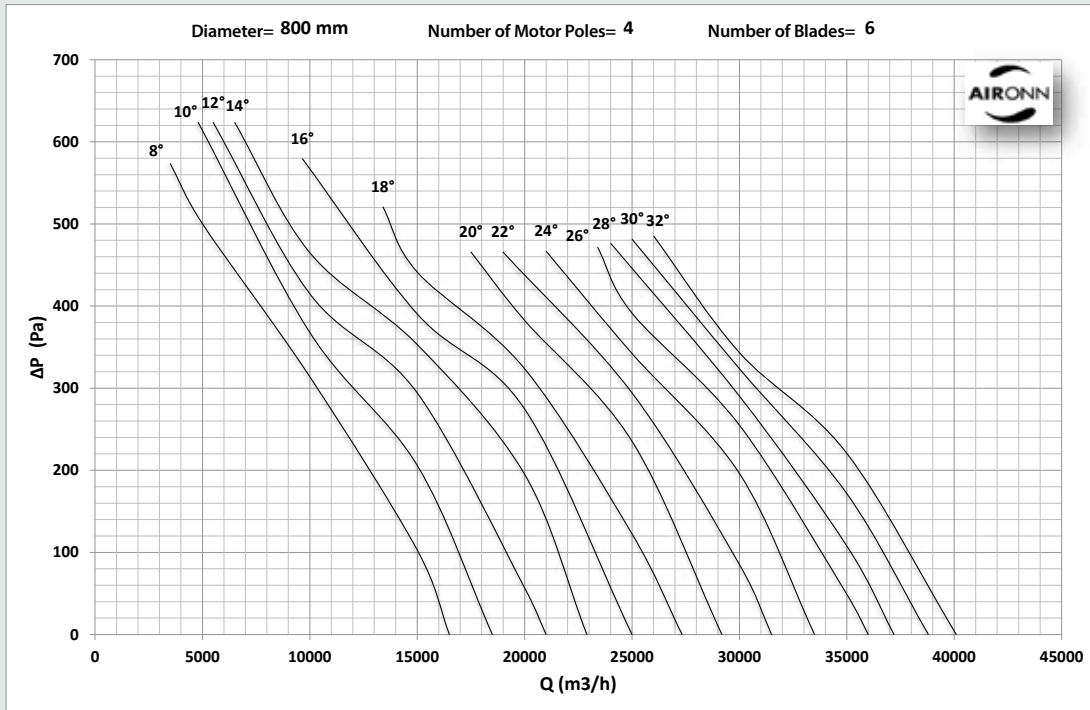

# Axial Hollow Fresh Air Fan Series

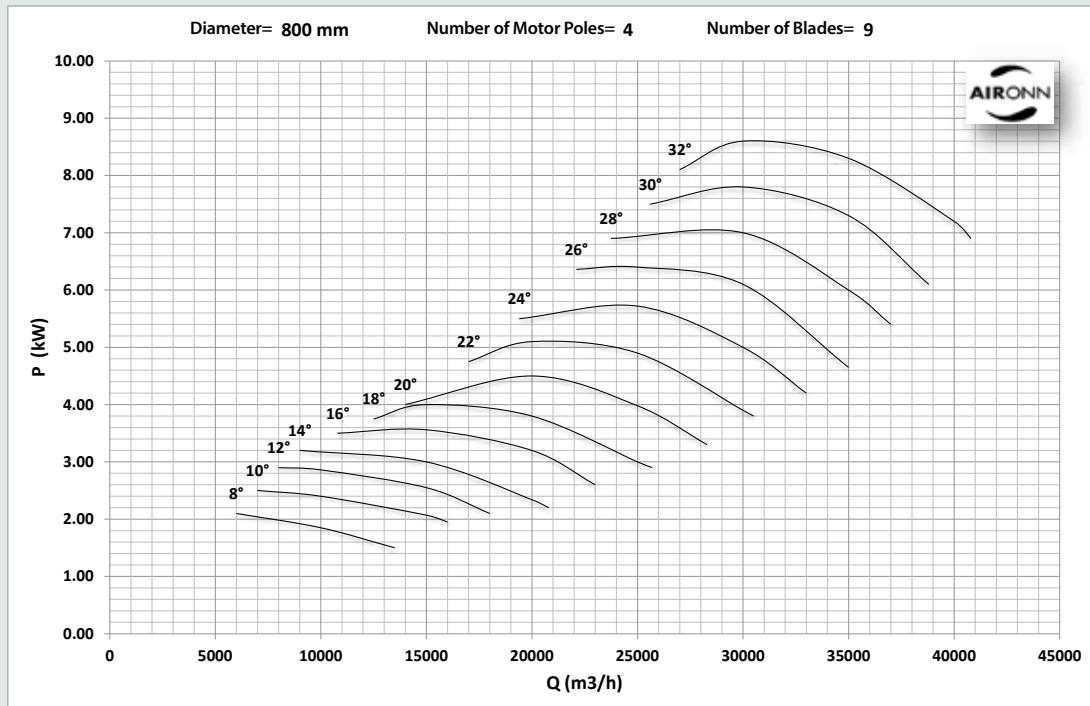
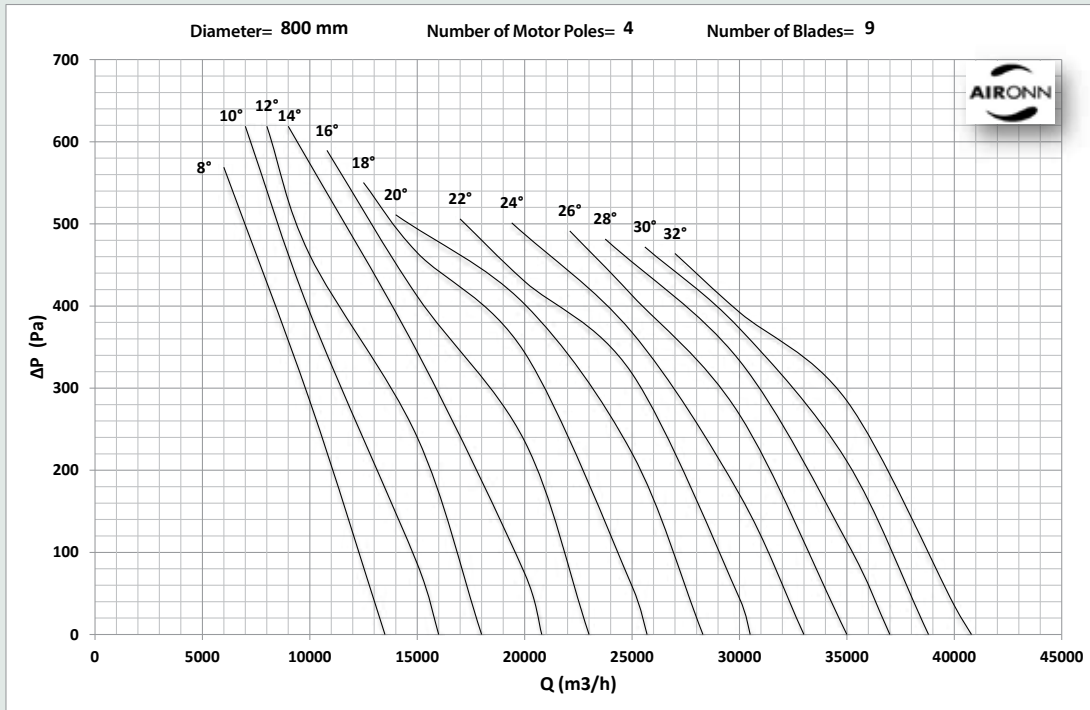

# Axial Hollow Fresh Air Fan Series

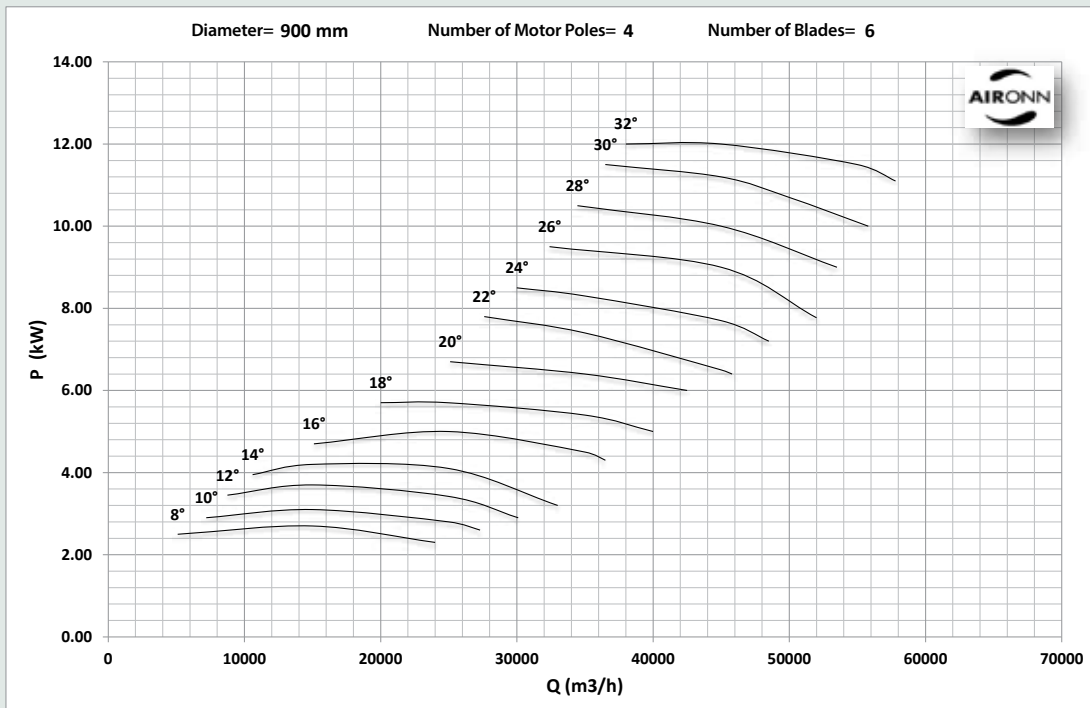
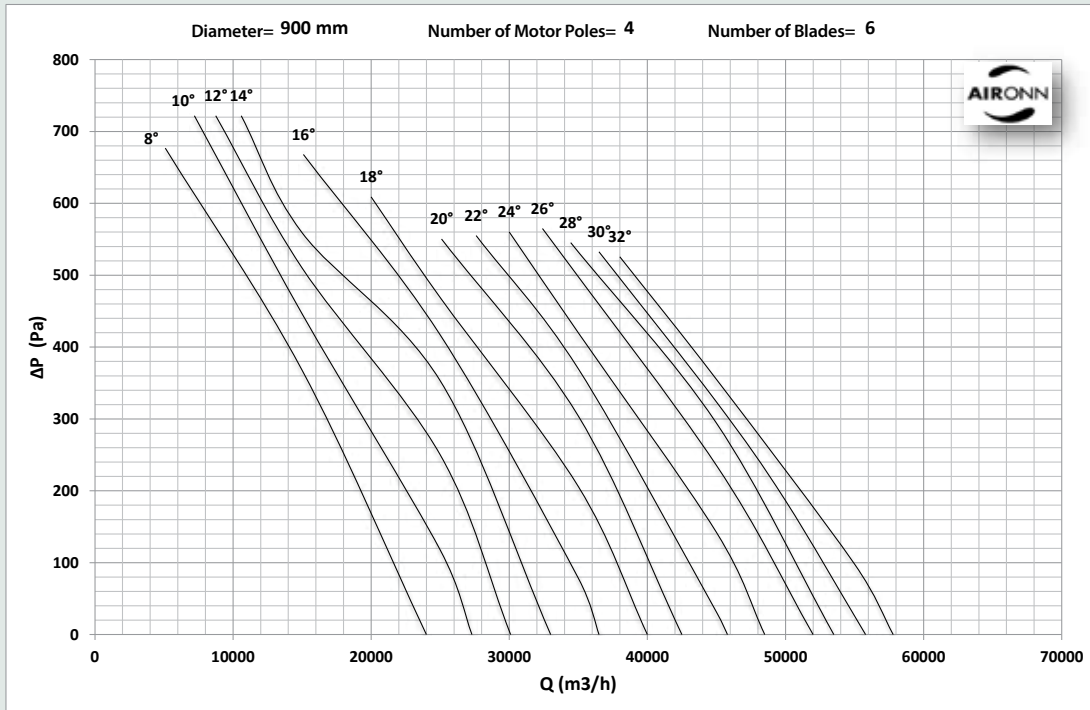

## Axial Hollow Fresh Air Fan Series

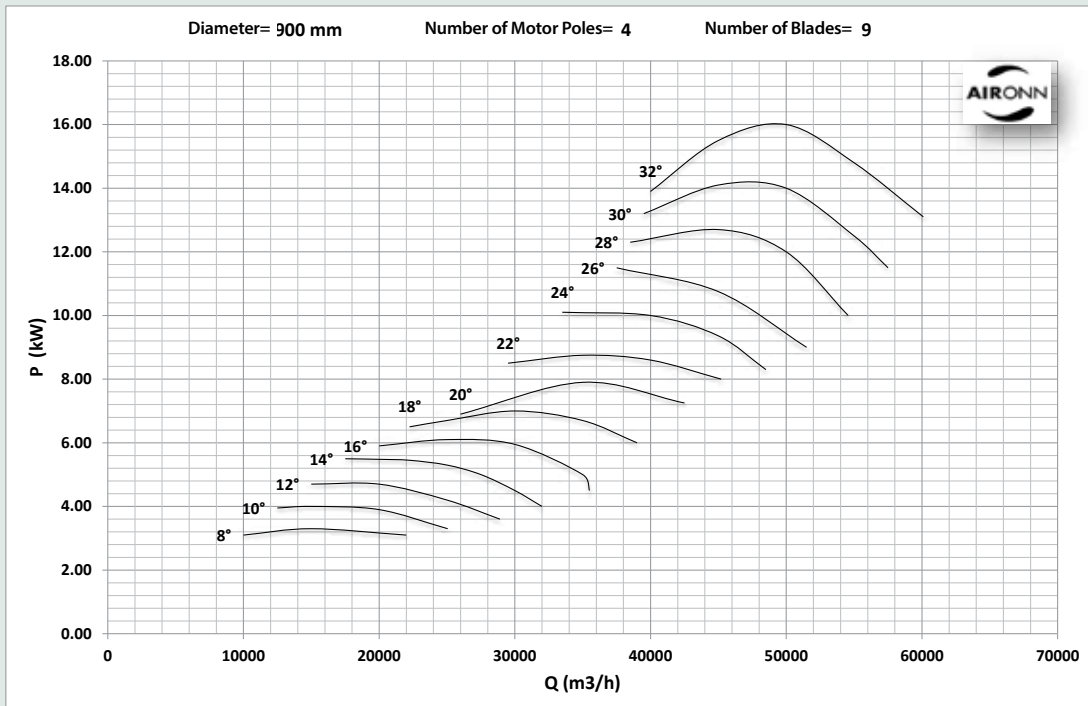
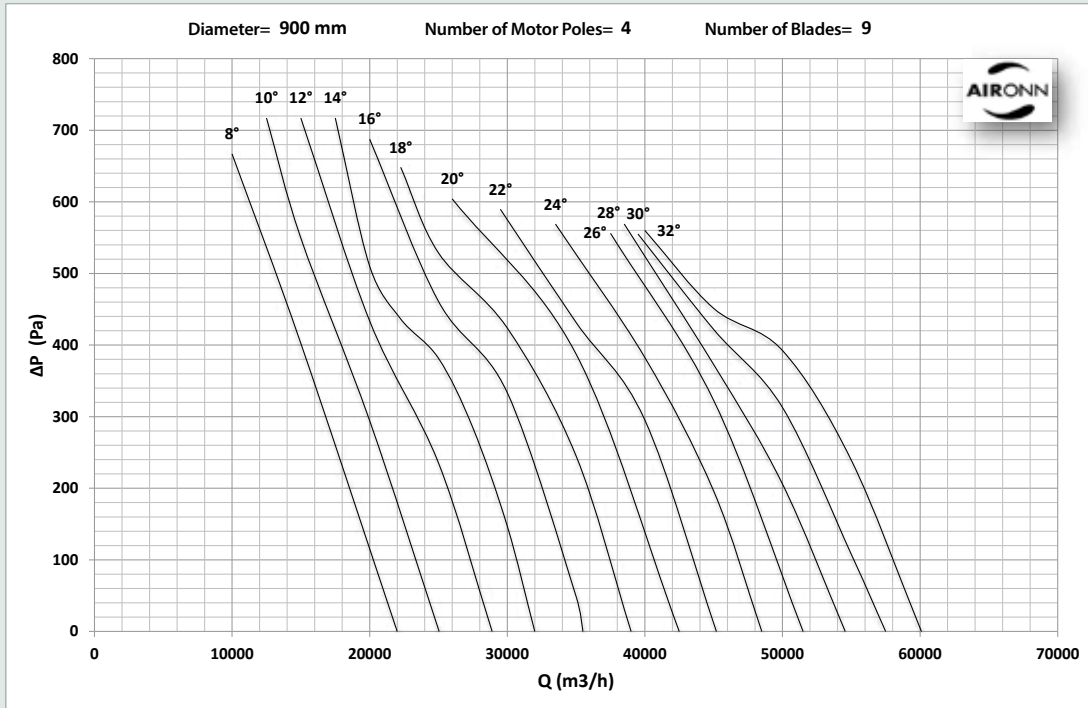



# Axial Hollow Fresh Air Fan Series

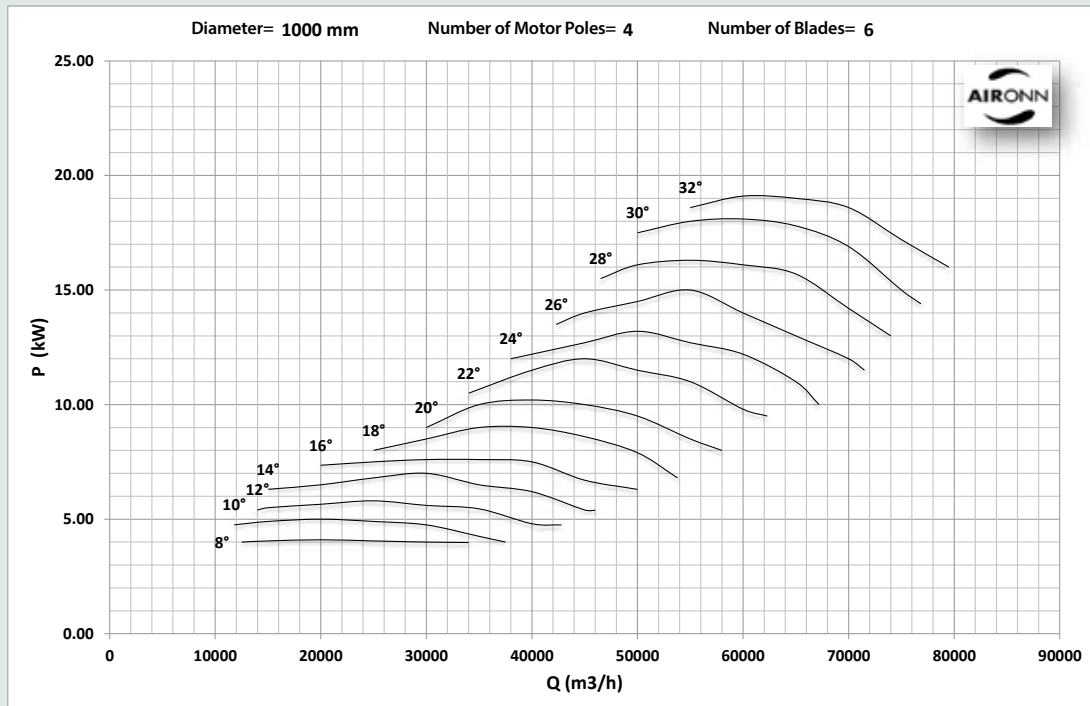
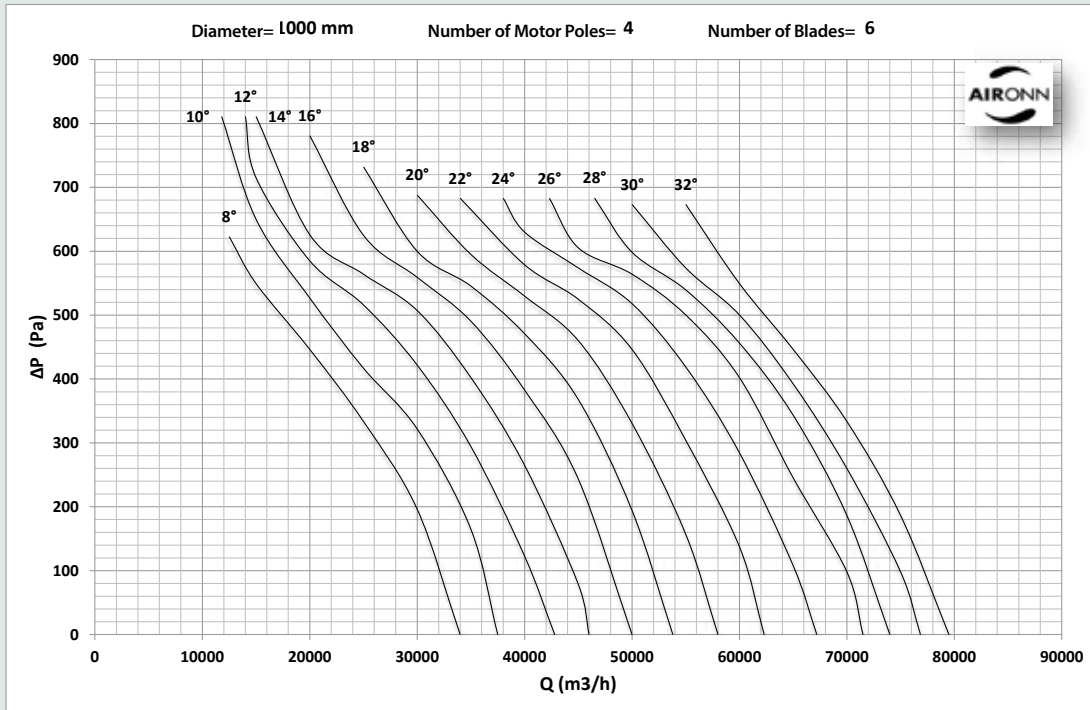

# Axial Hollow Fresh Air Fan Series

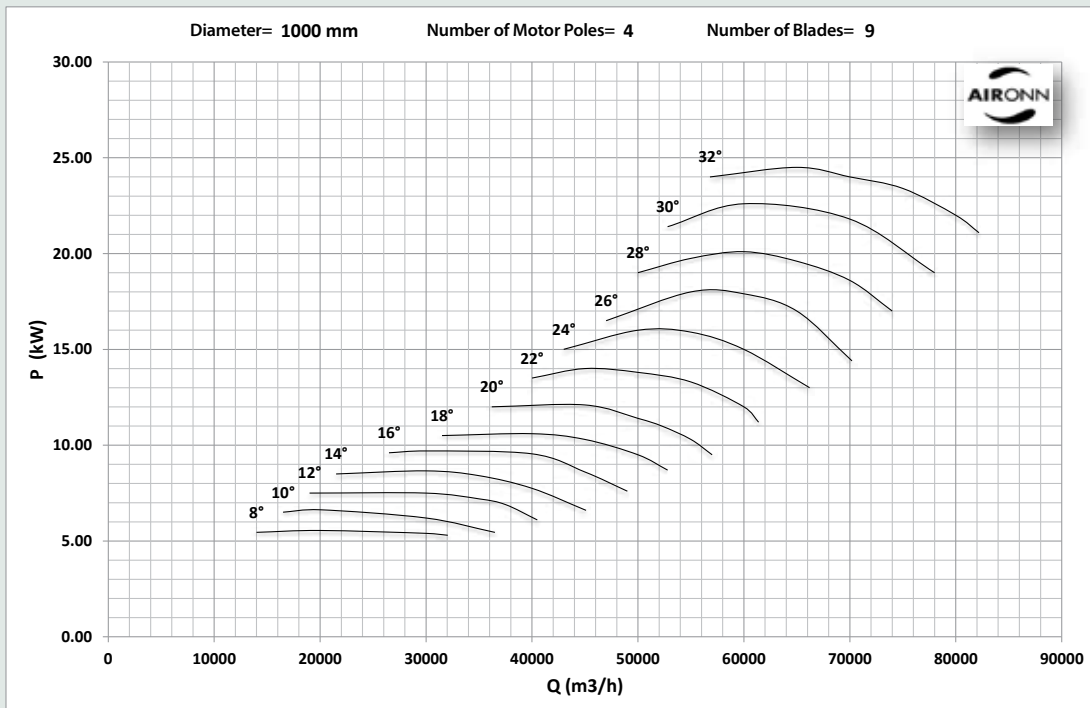
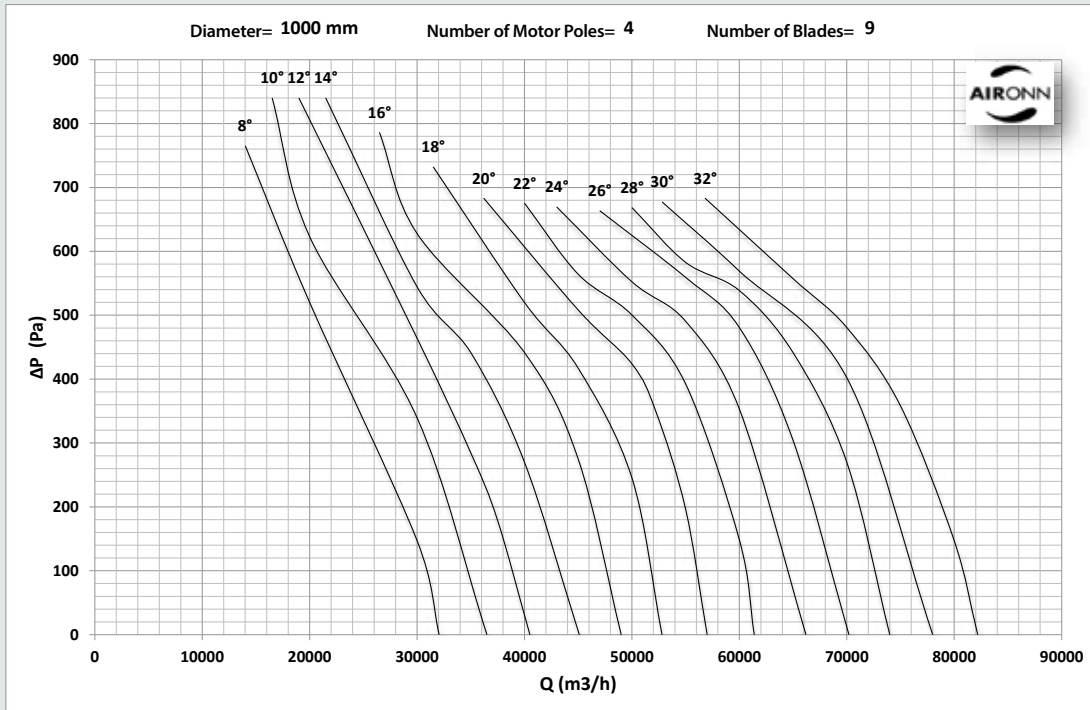

# Axial Hollow Fresh Air Fan Series

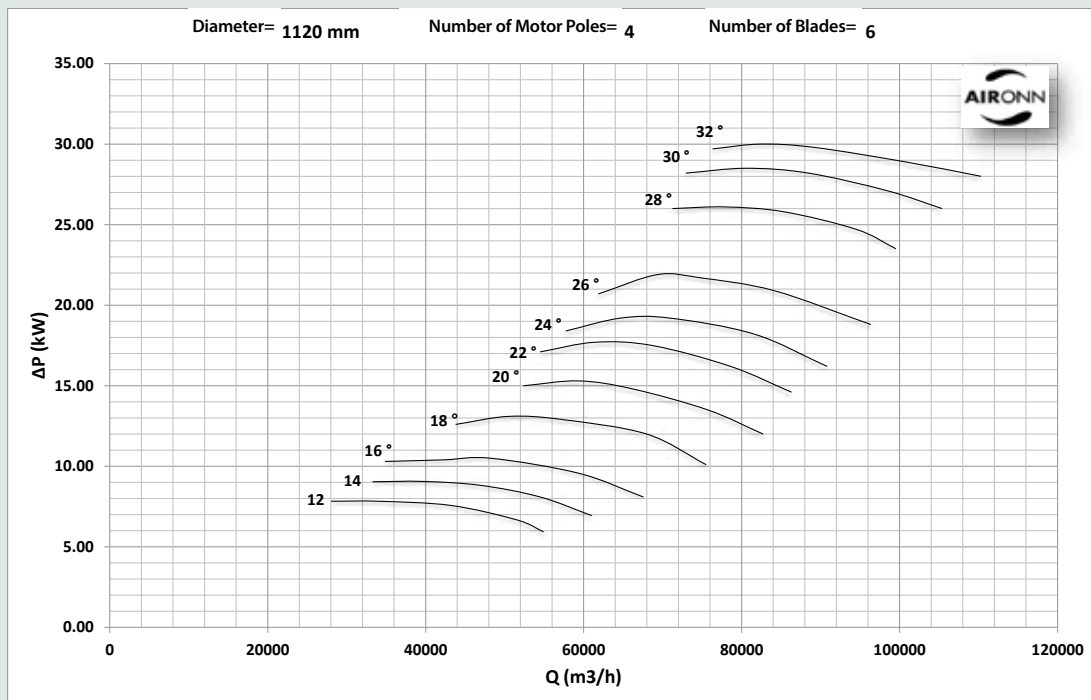
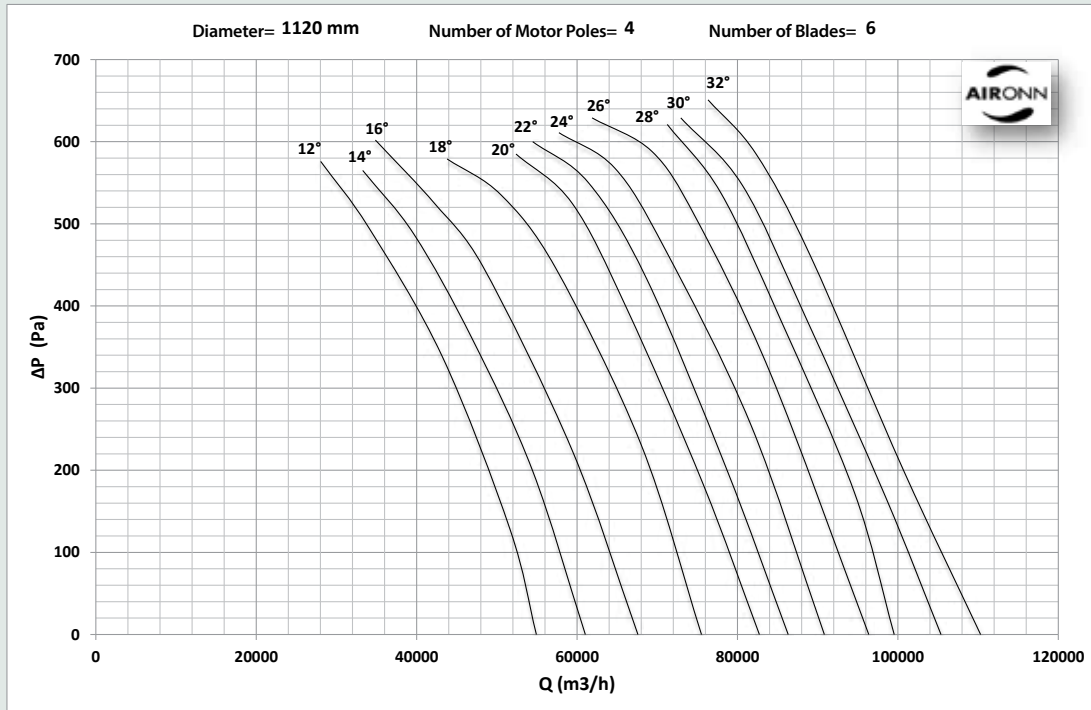

# Axial Hollow Fresh Air Fan Series

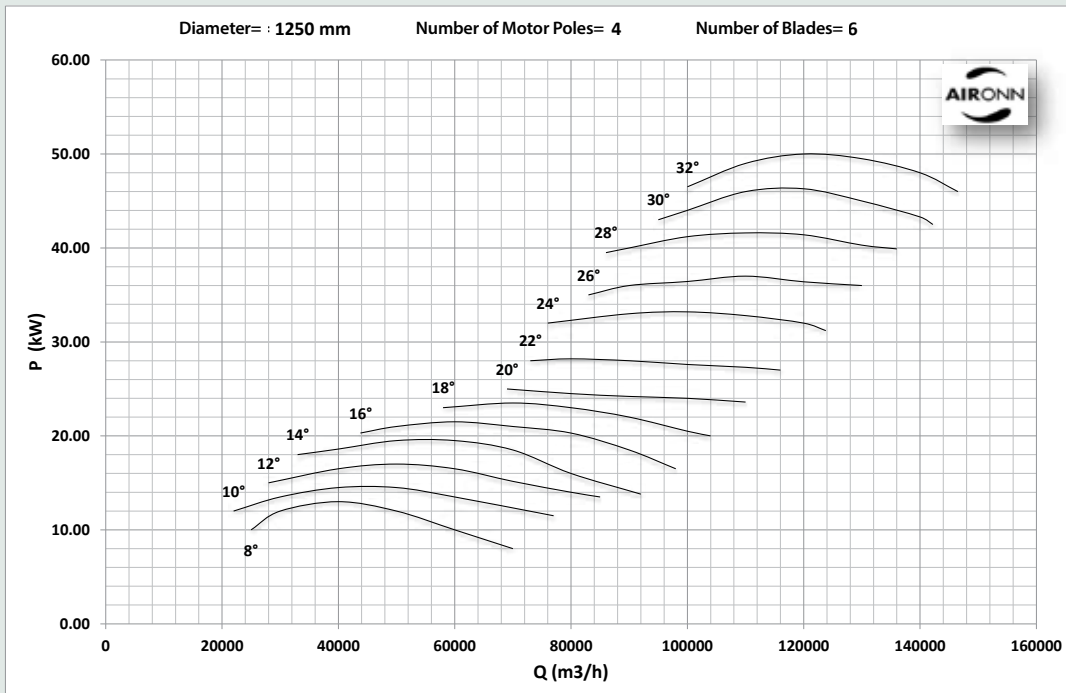
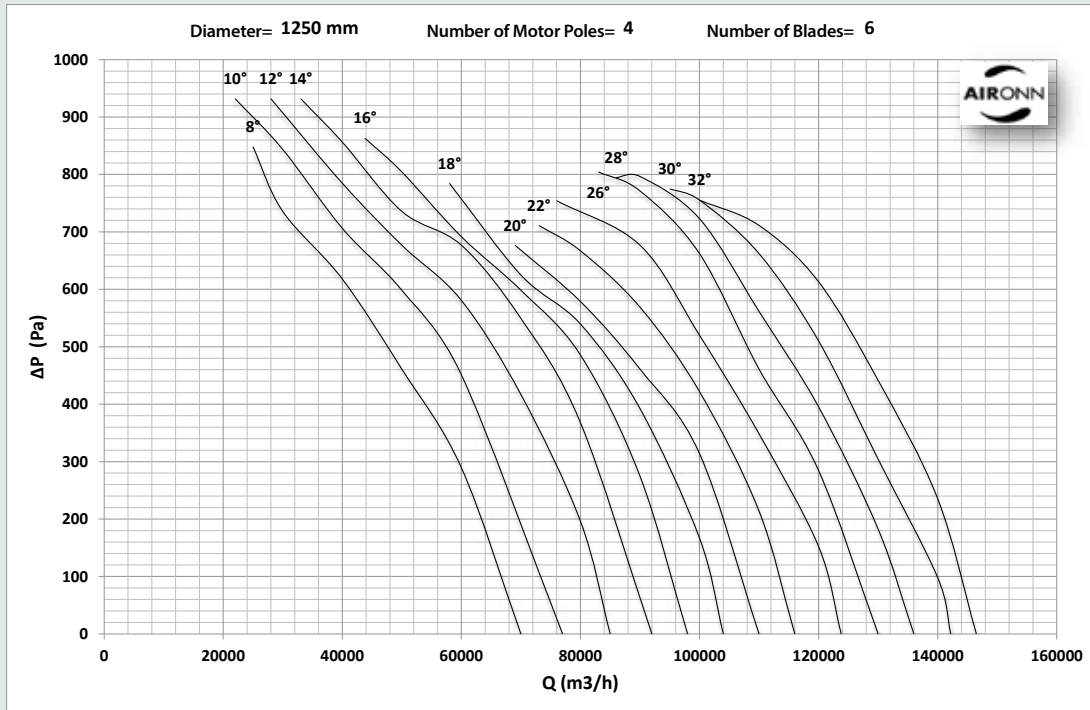

# Axial Hollow Fresh Air Fan Series

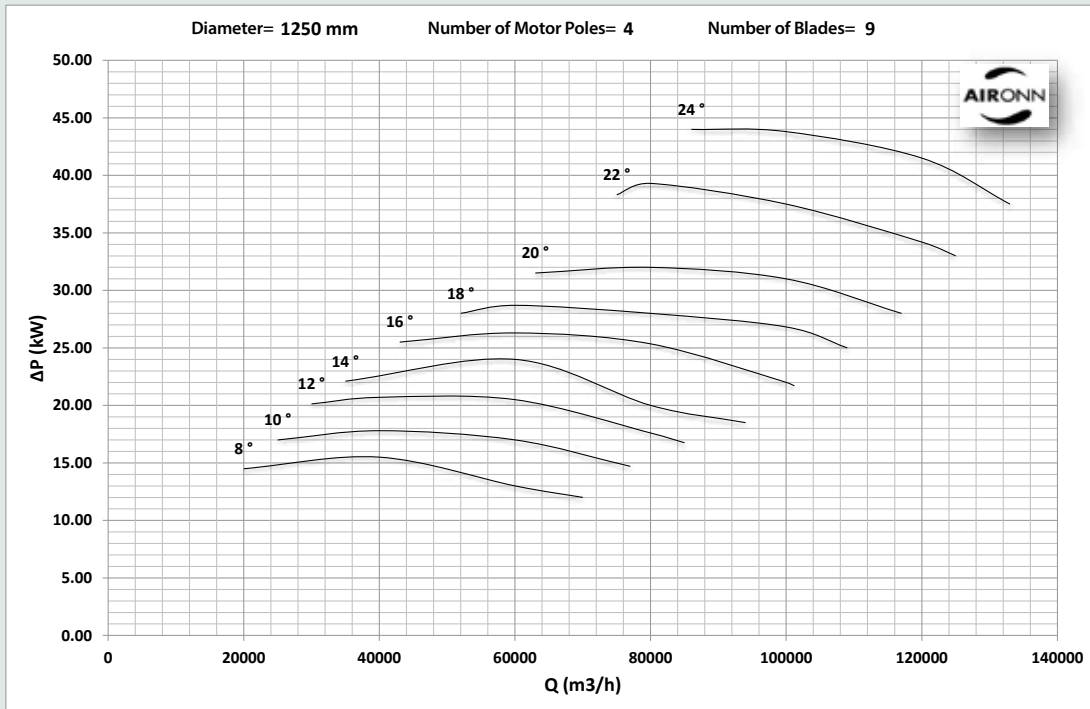
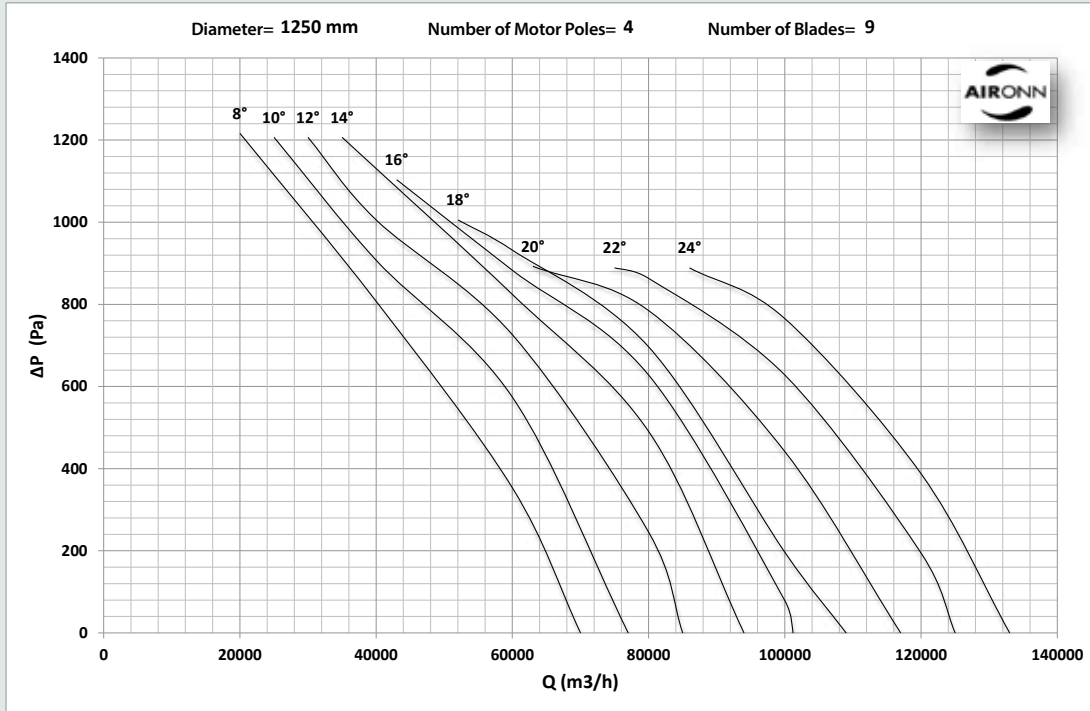

# Axial Hollow Smoke Exhaust Fan Series

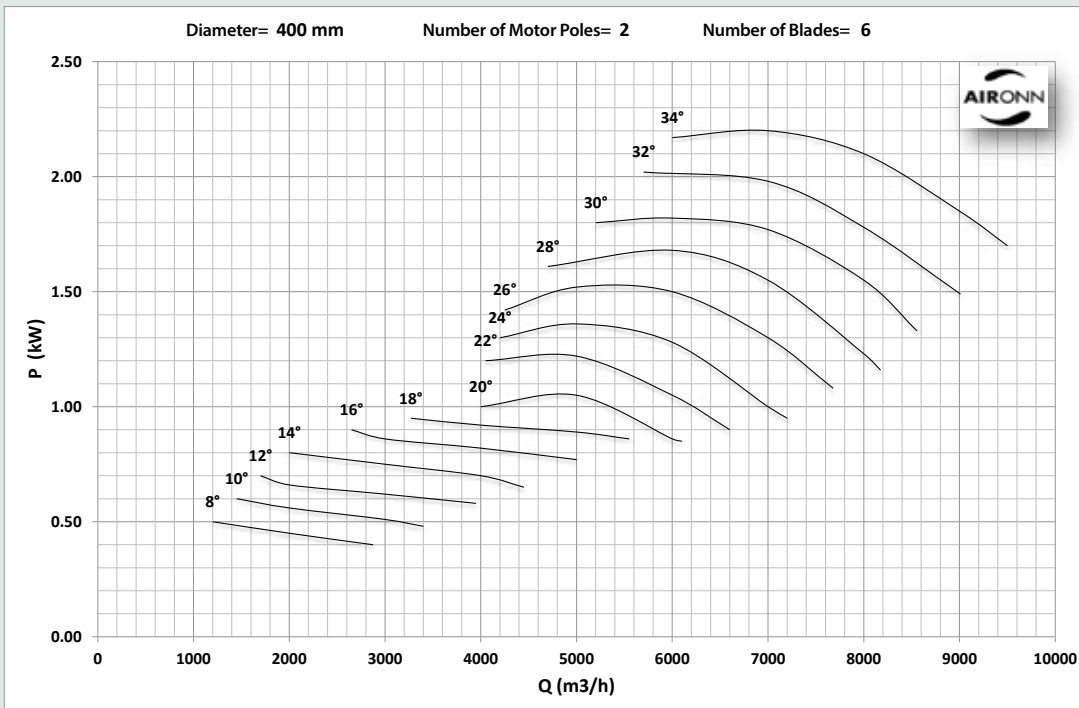
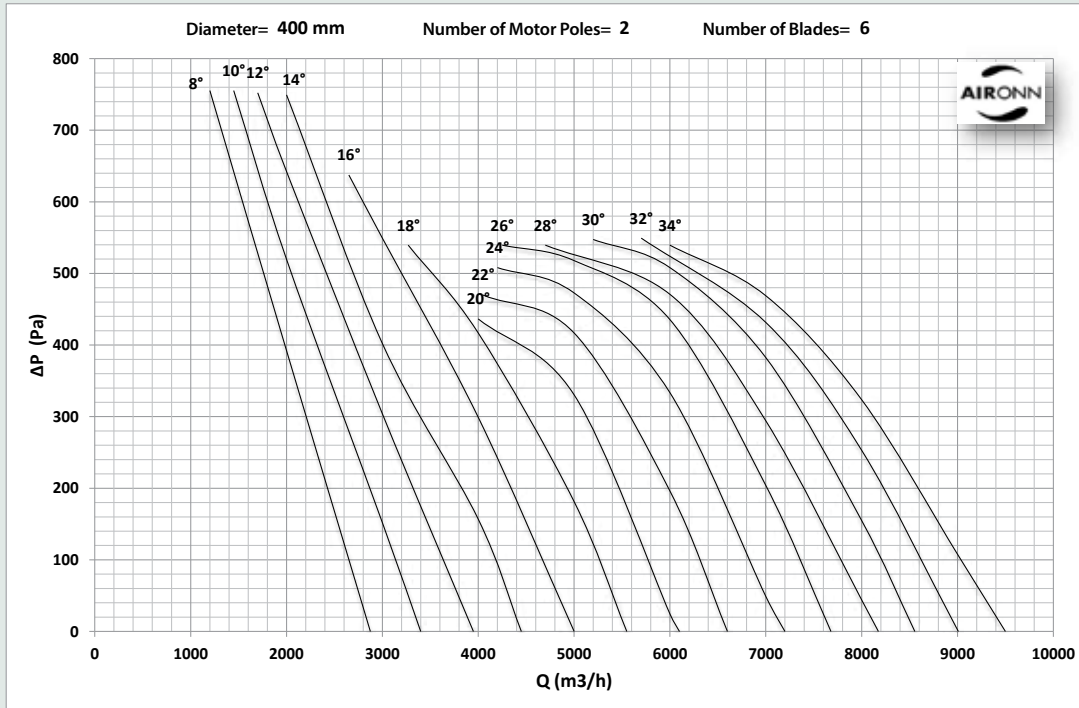

# Axial Hollow Smoke Exhaust Fan Series

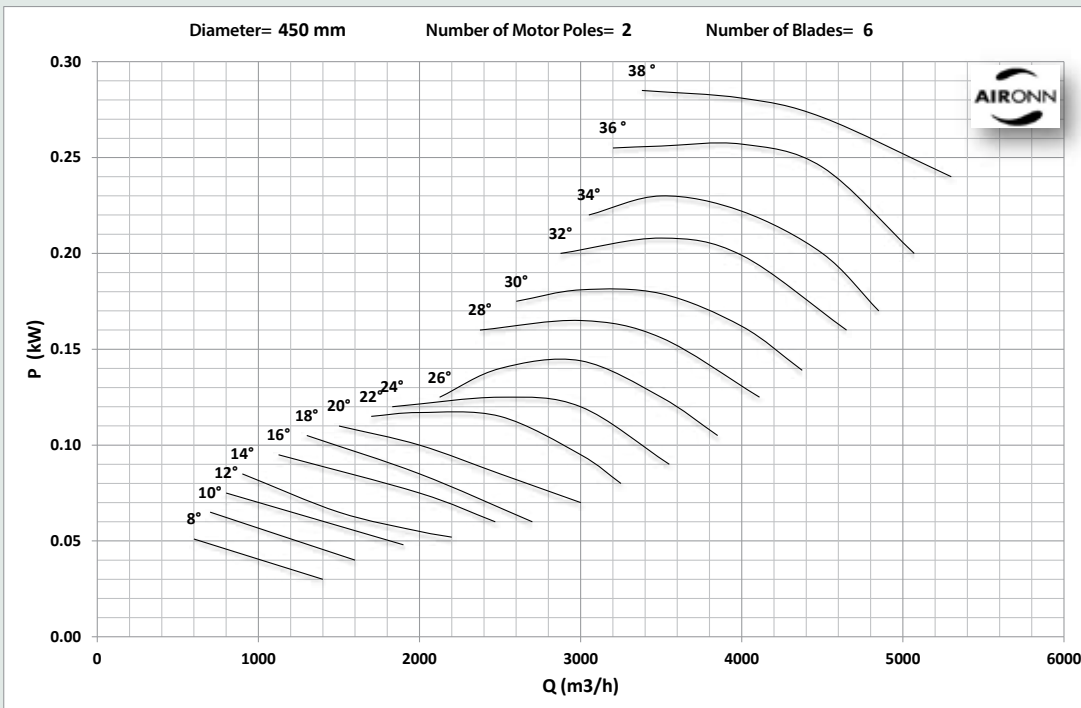
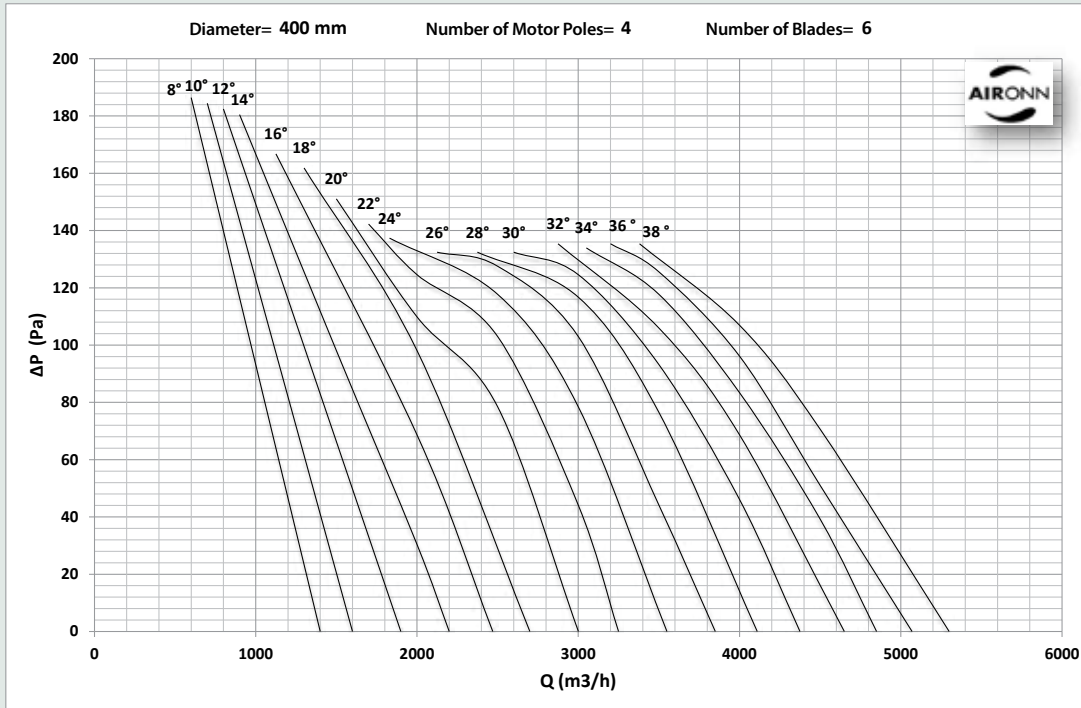

# Axial Hollow Smoke Exhaust Fan Series

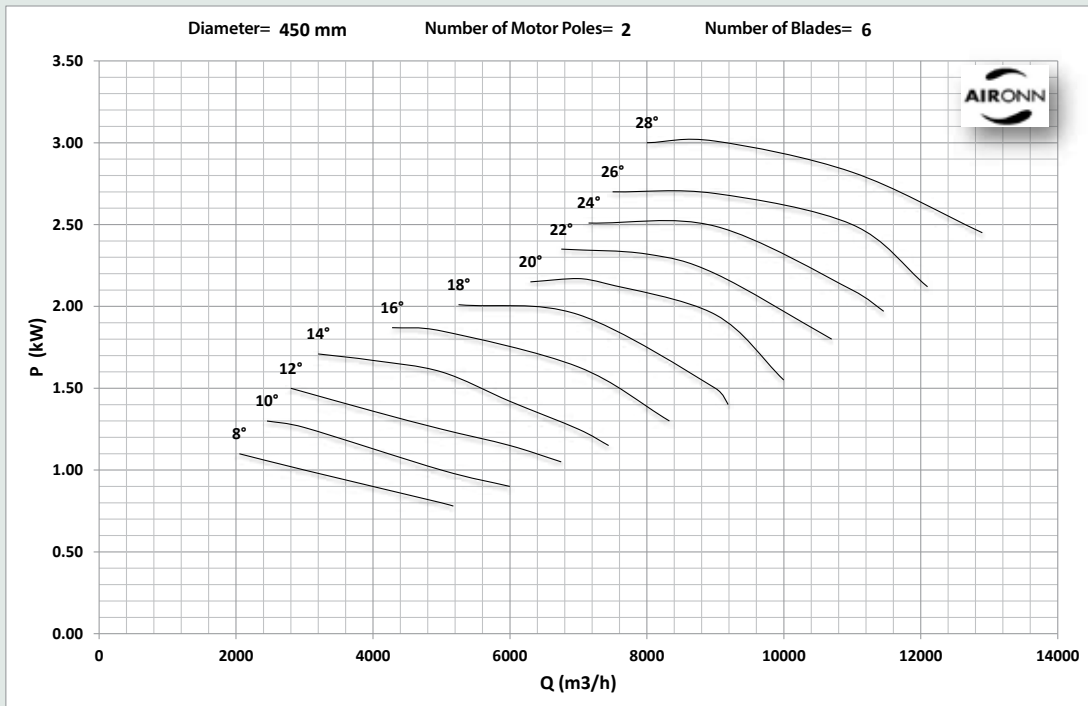
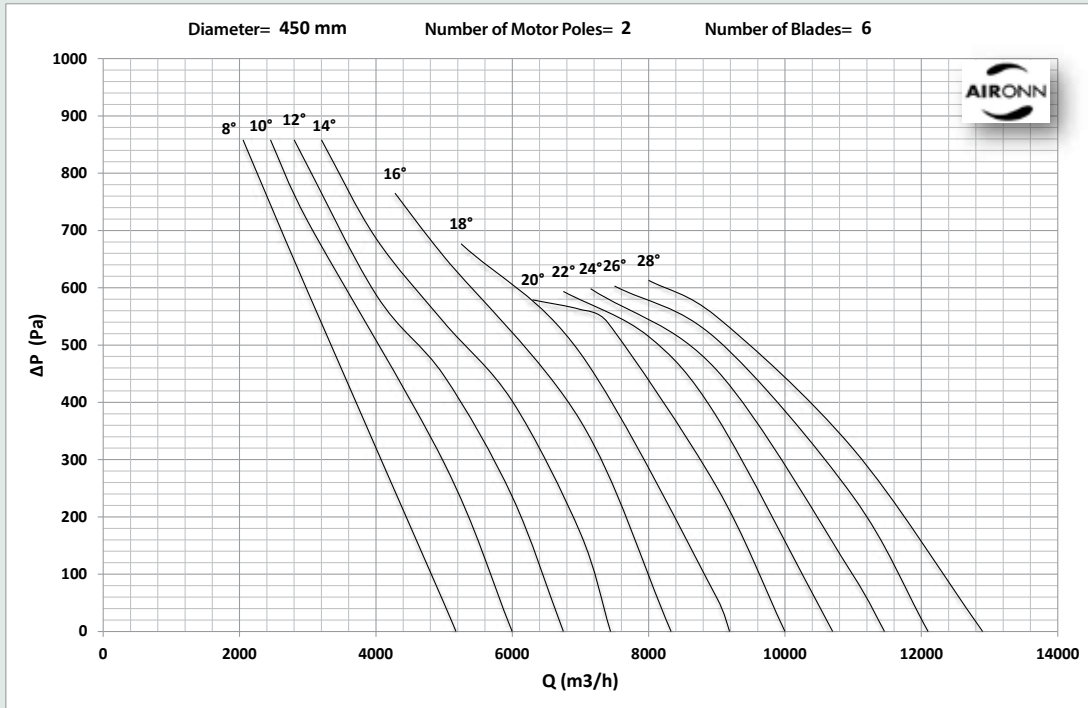



# Axial Hollow Smoke Exhaust Fan Series

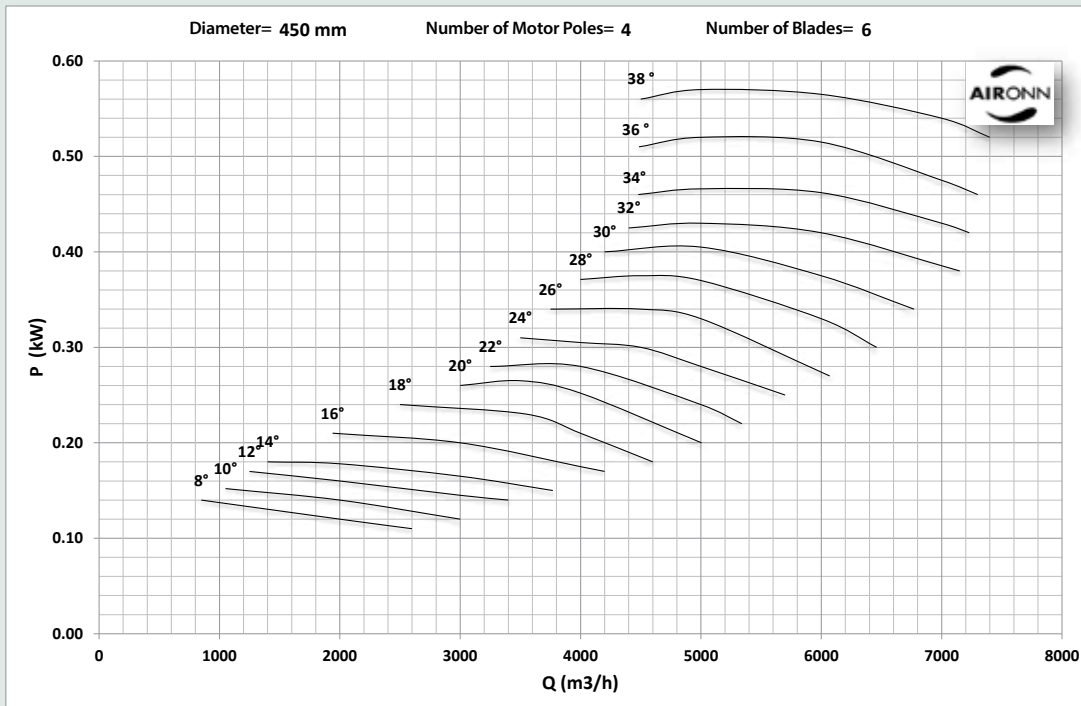
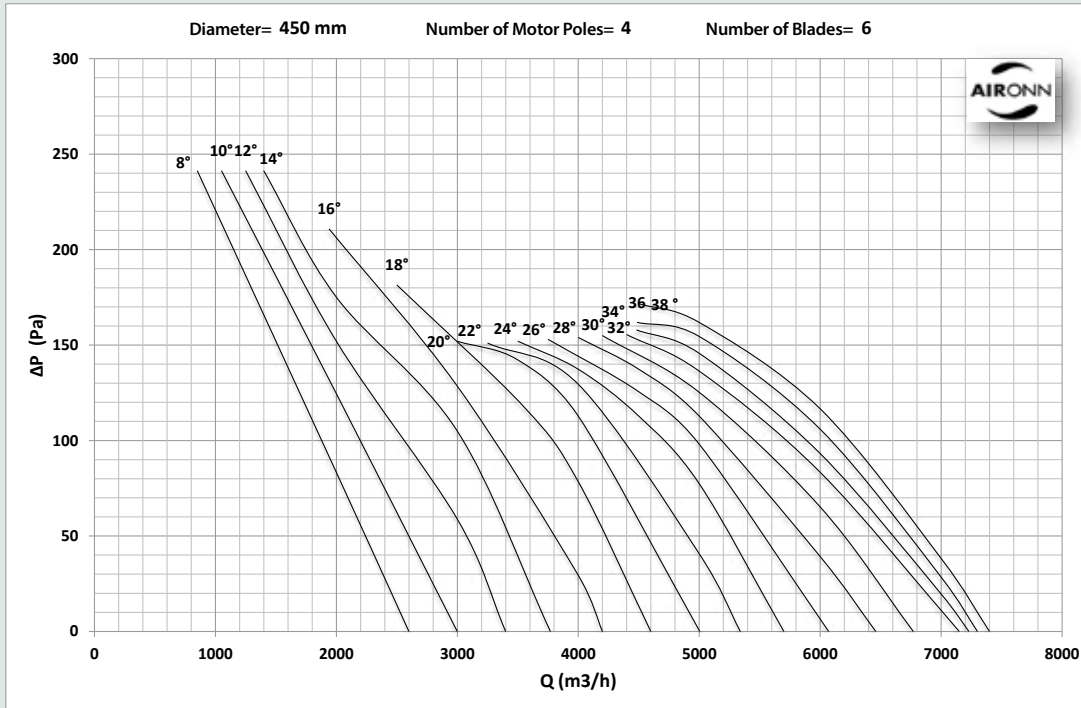

# Axial Hollow Smoke Exhaust Fan Series

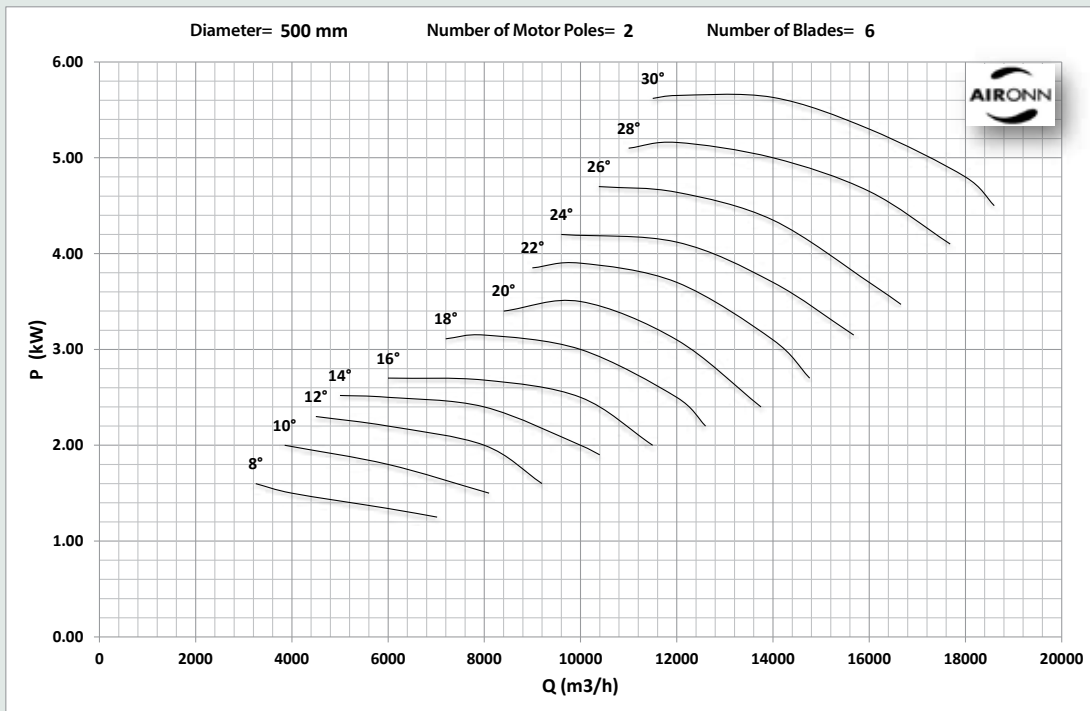
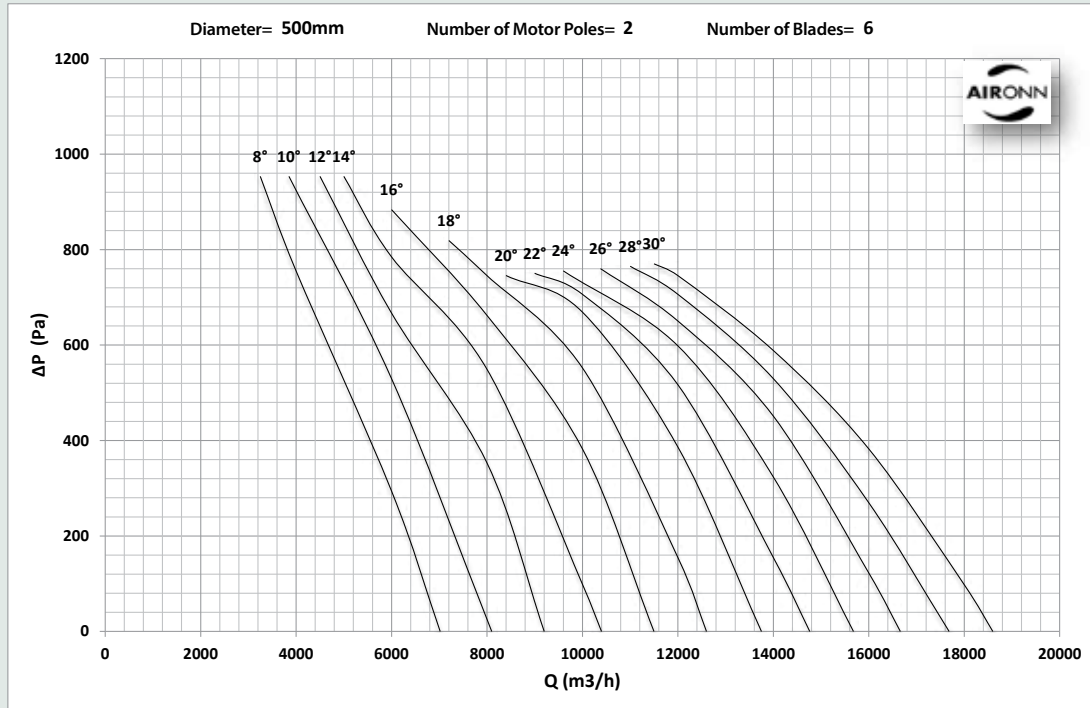

# Axial Hollow Smoke Exhaust Fan Series

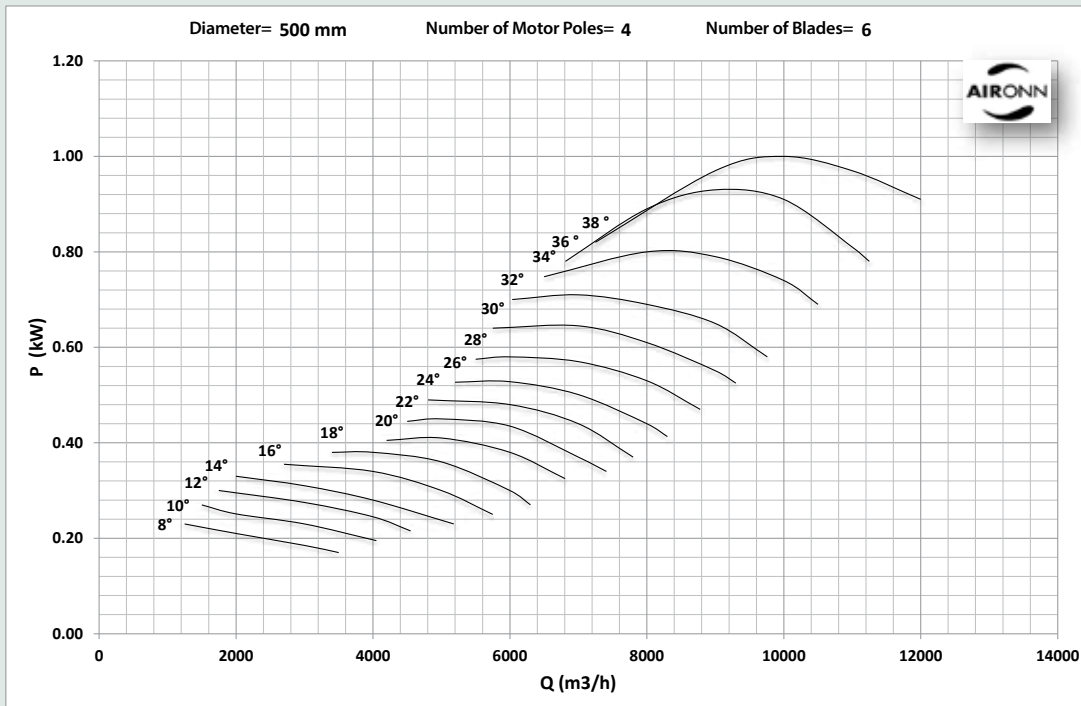
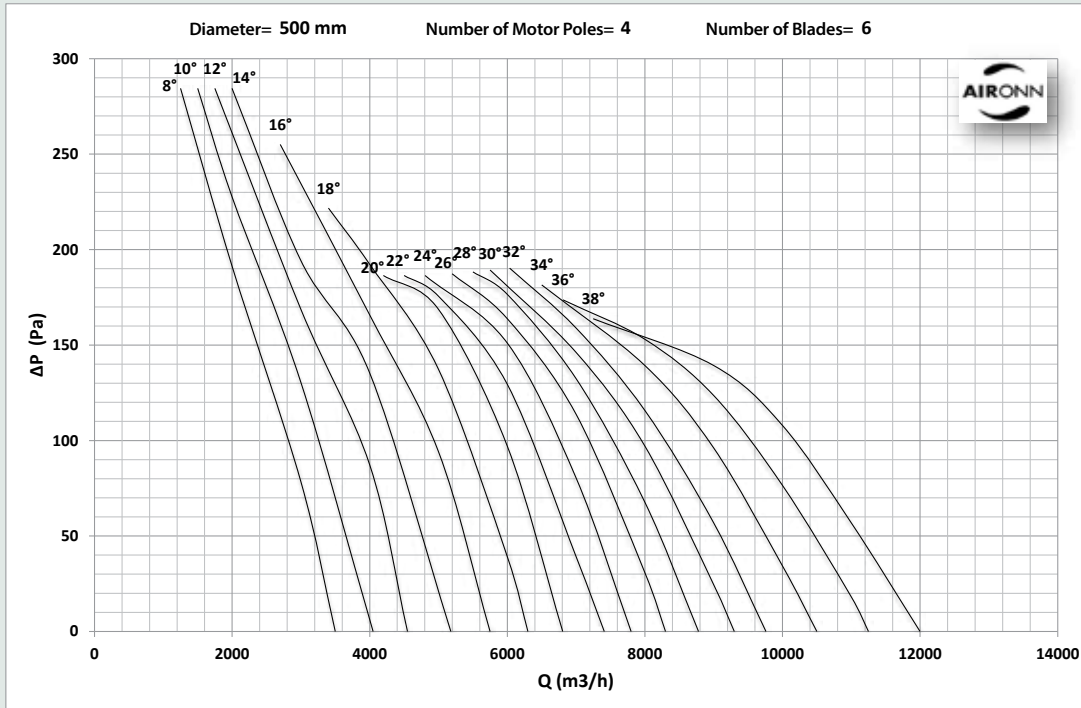

# Axial Hollow Smoke Exhaust Fan Series

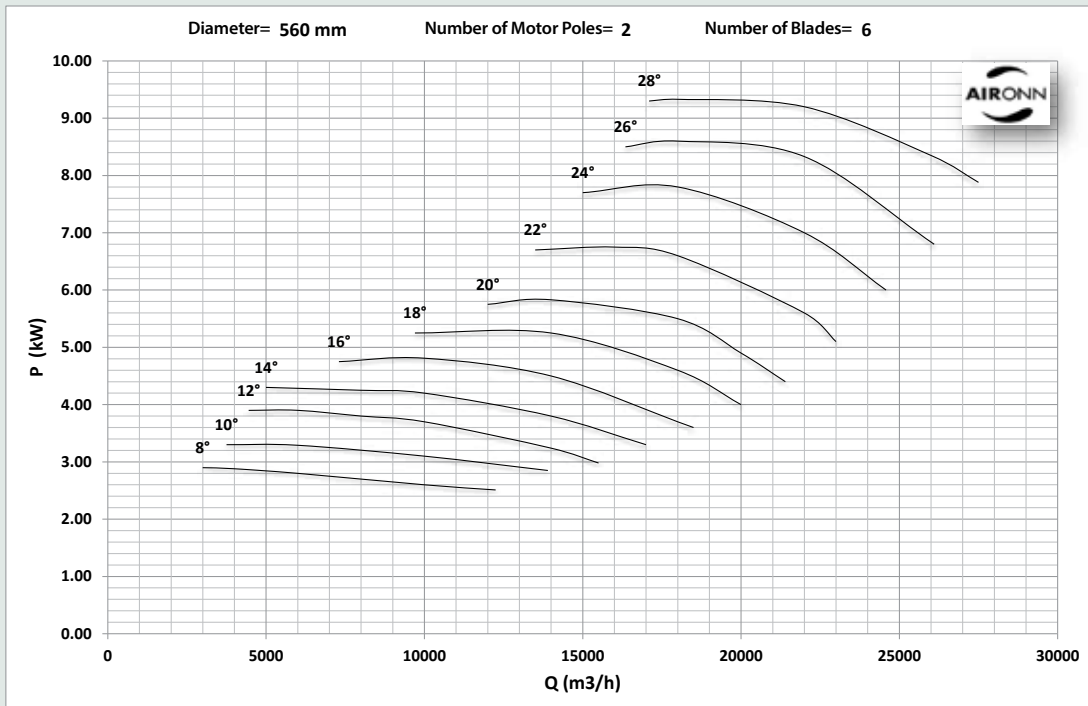
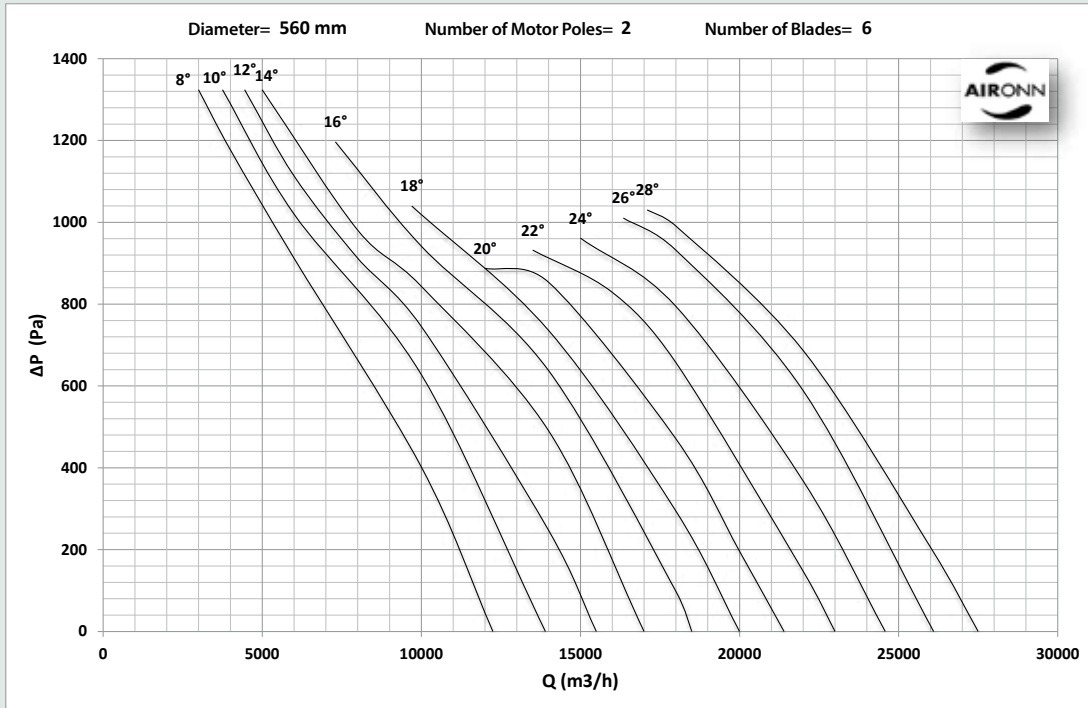

# Axial Hollow Smoke Exhaust Fan Series

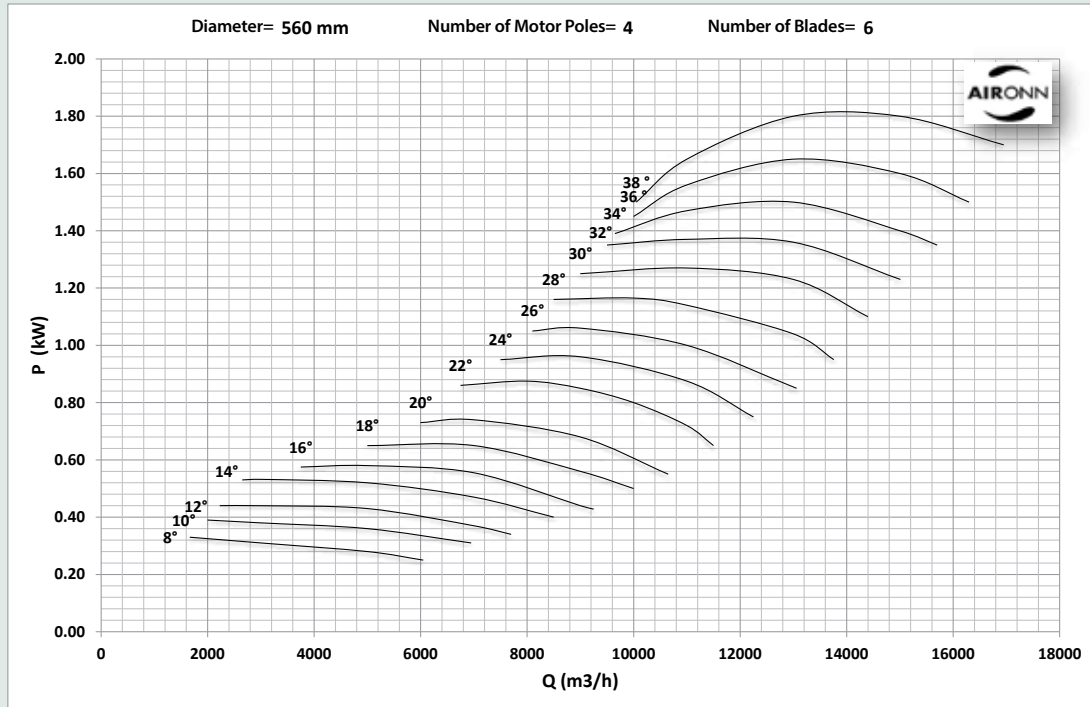
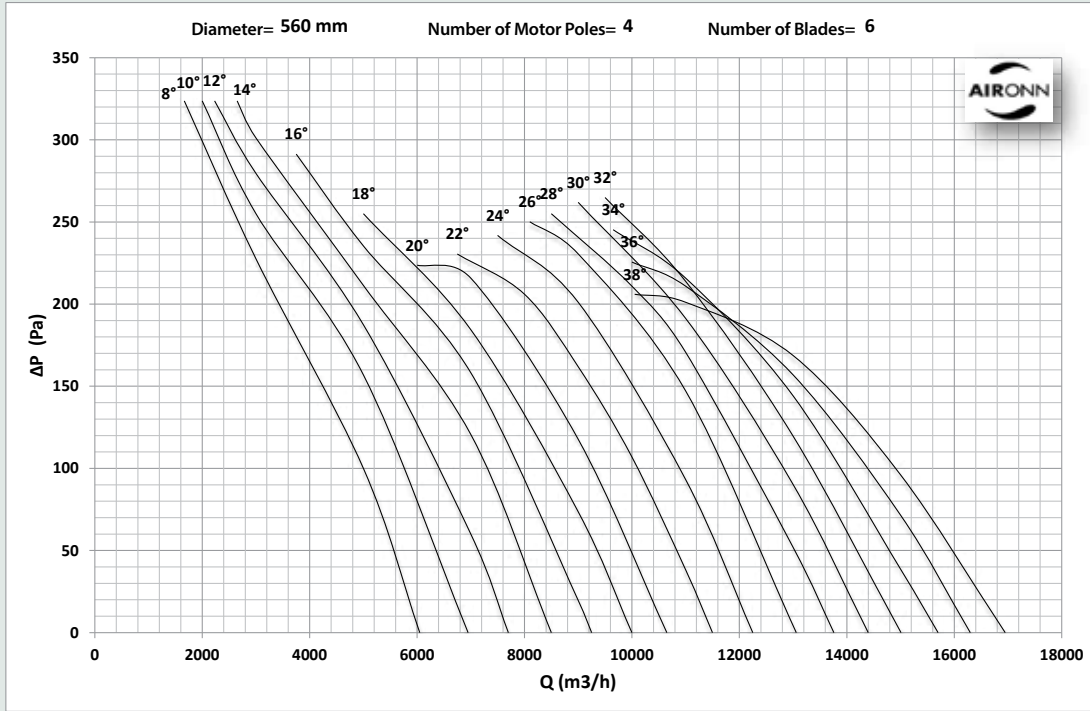

# Axial Hollow Smoke Exhaust Fan Series

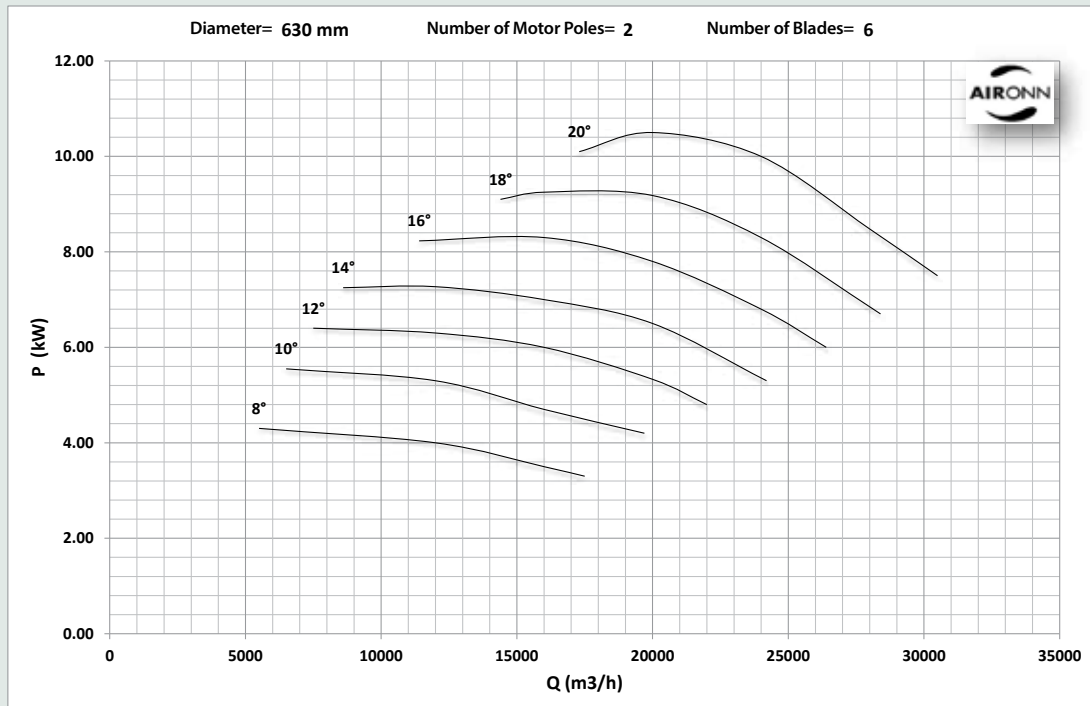
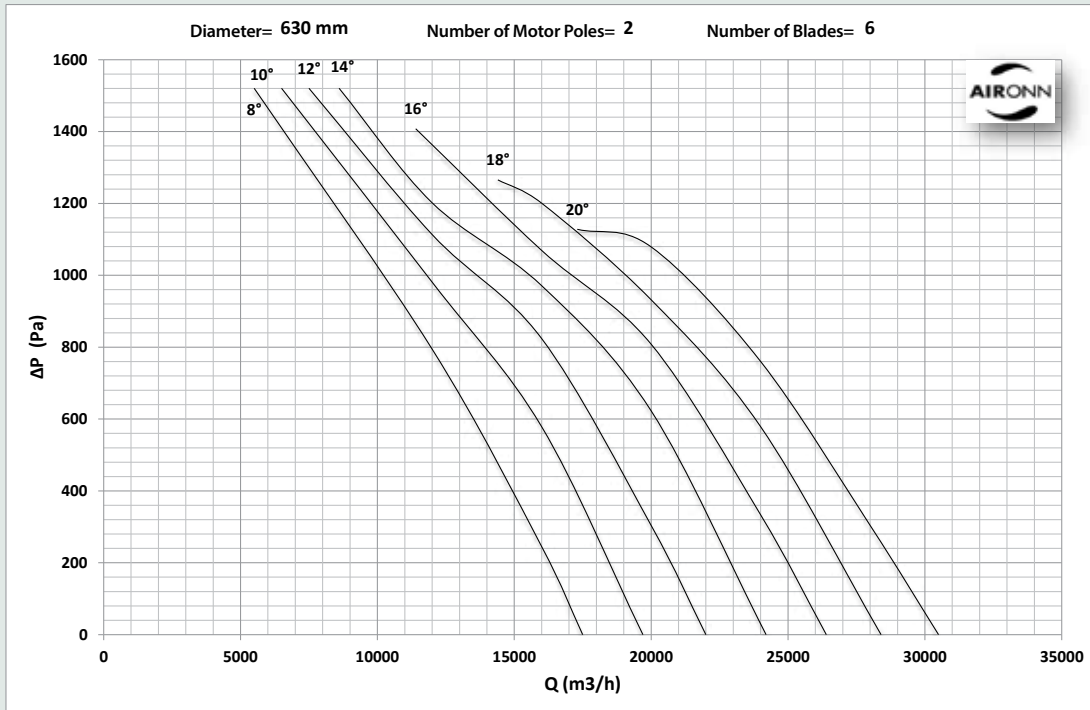

# Axial Hollow Smoke Exhaust Fan Series

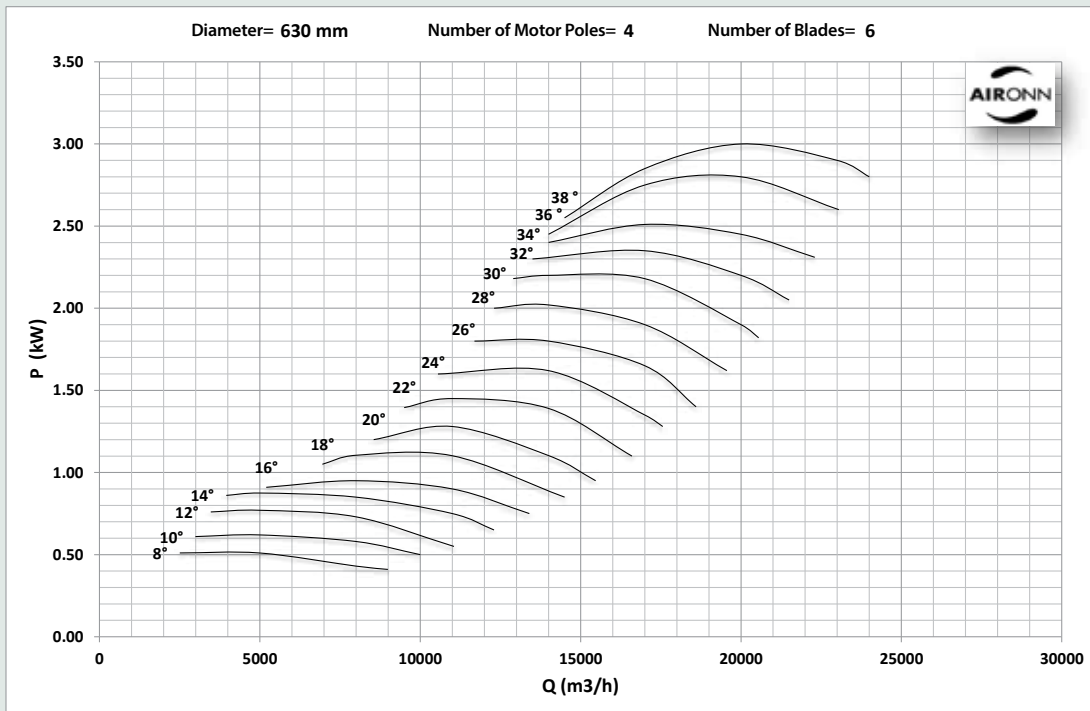
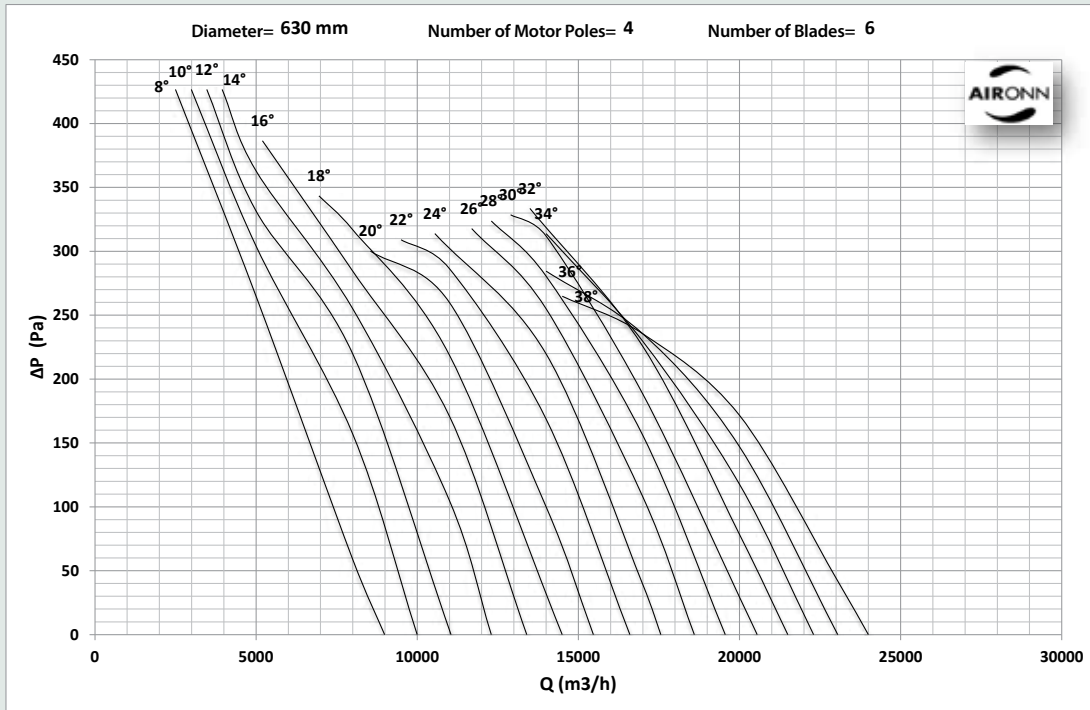

# Axial Hollow Smoke Exhaust Fan Series

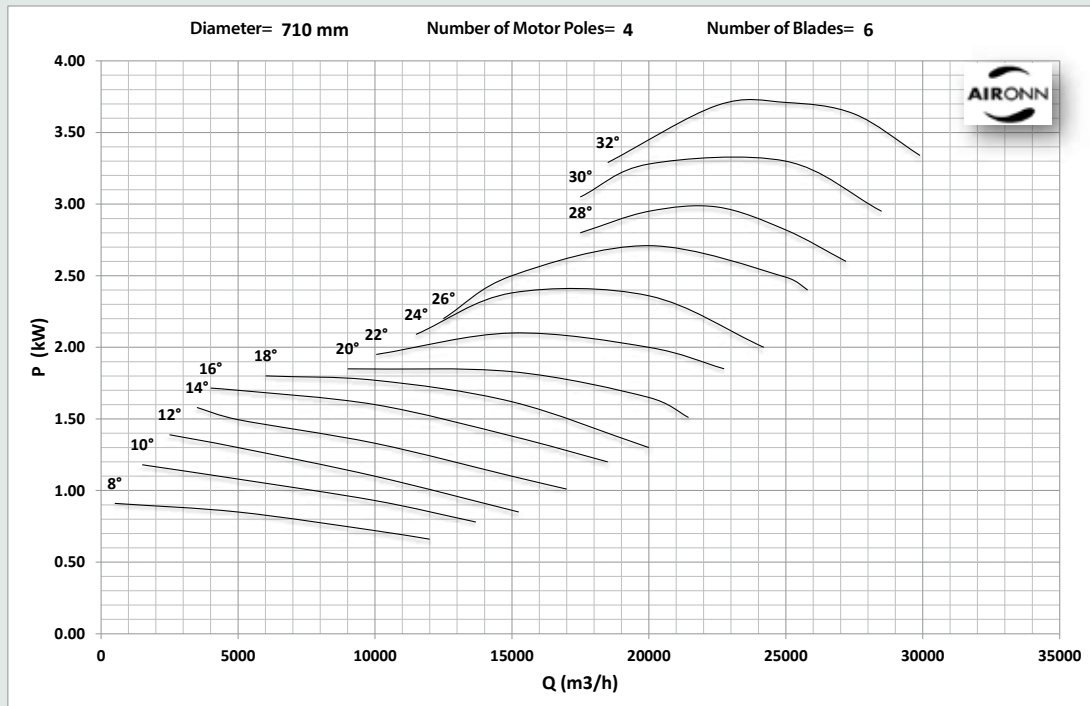
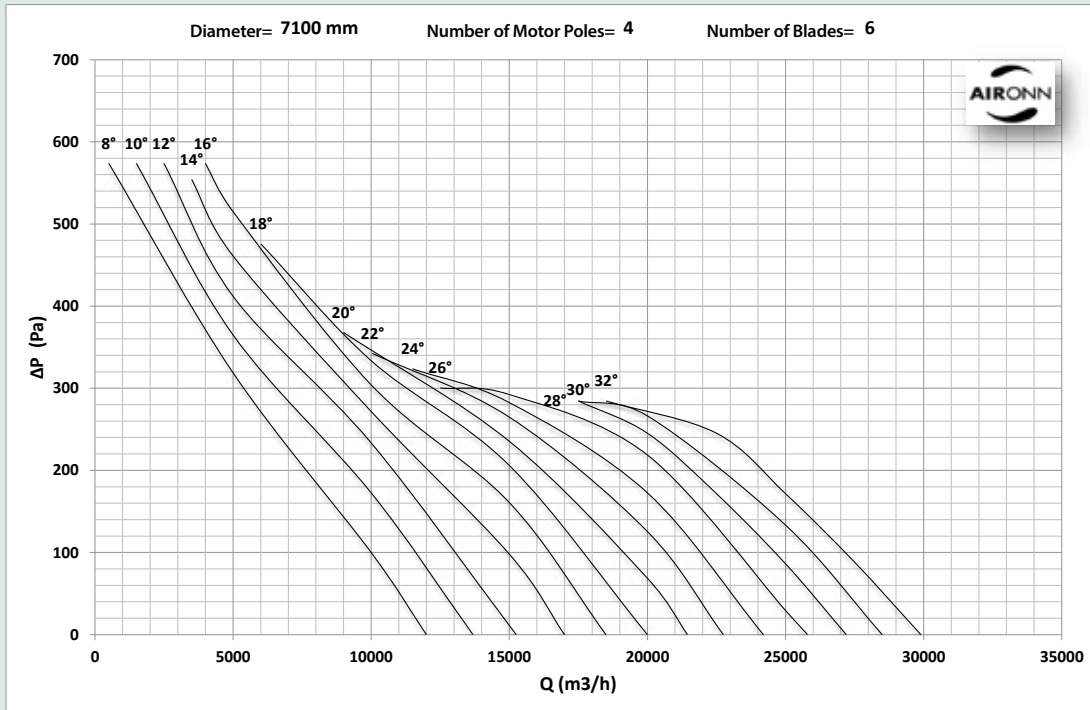



# Axial Hollow Smoke Exhaust Fan Series

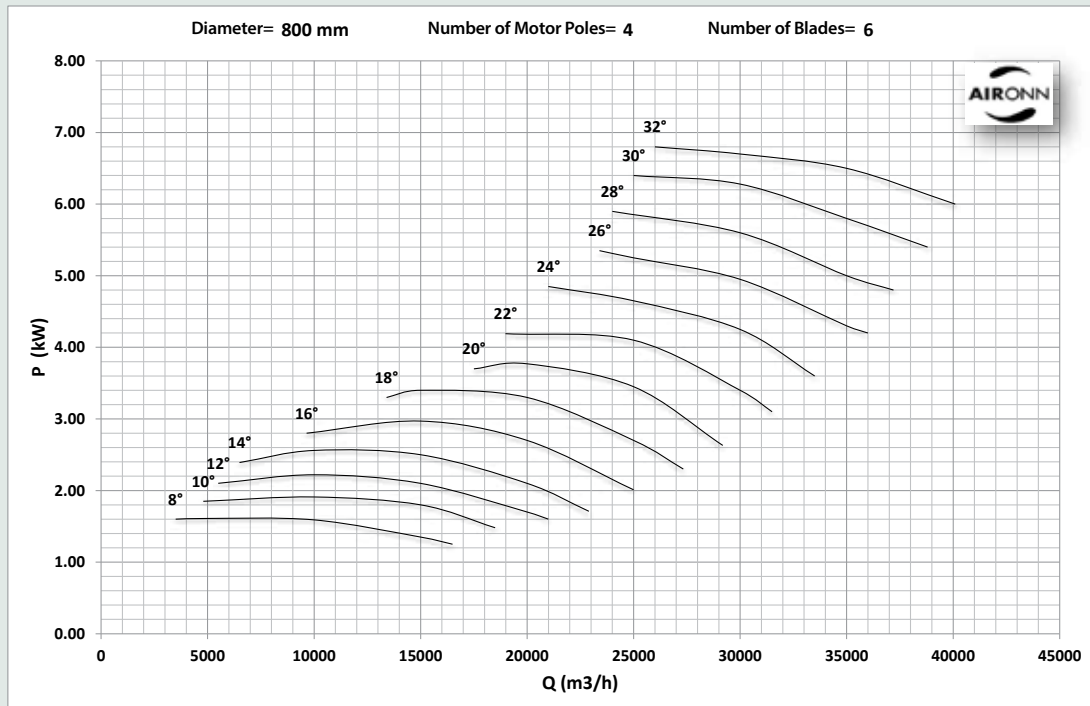
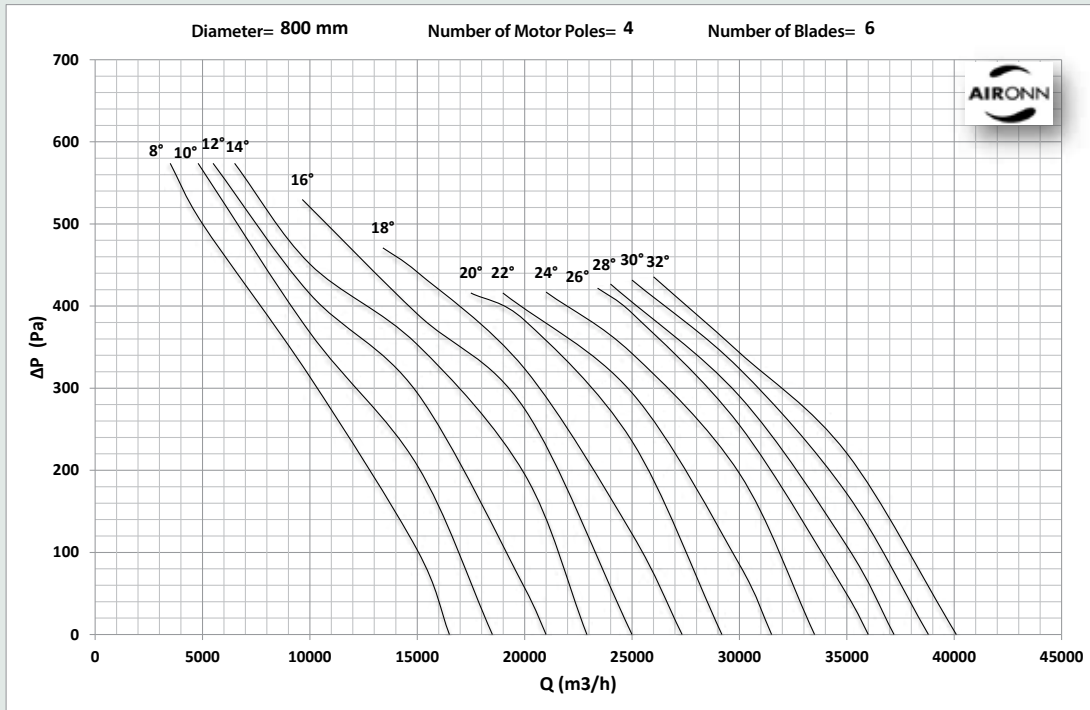

# Axial Hollow Smoke Exhaust Fan Series

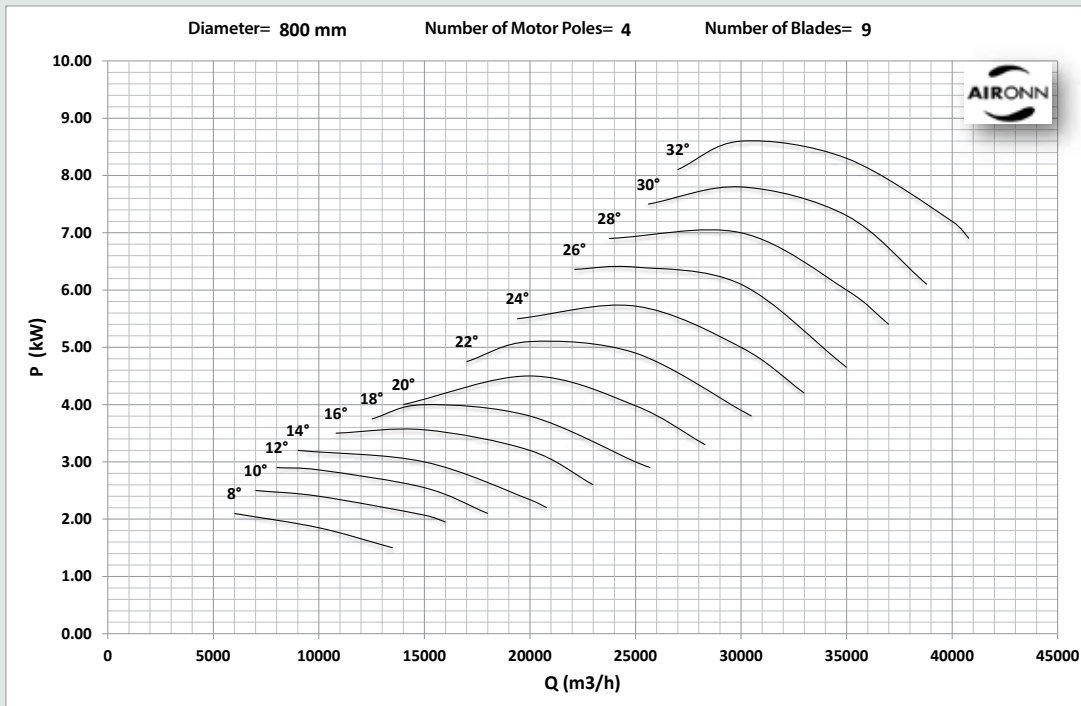
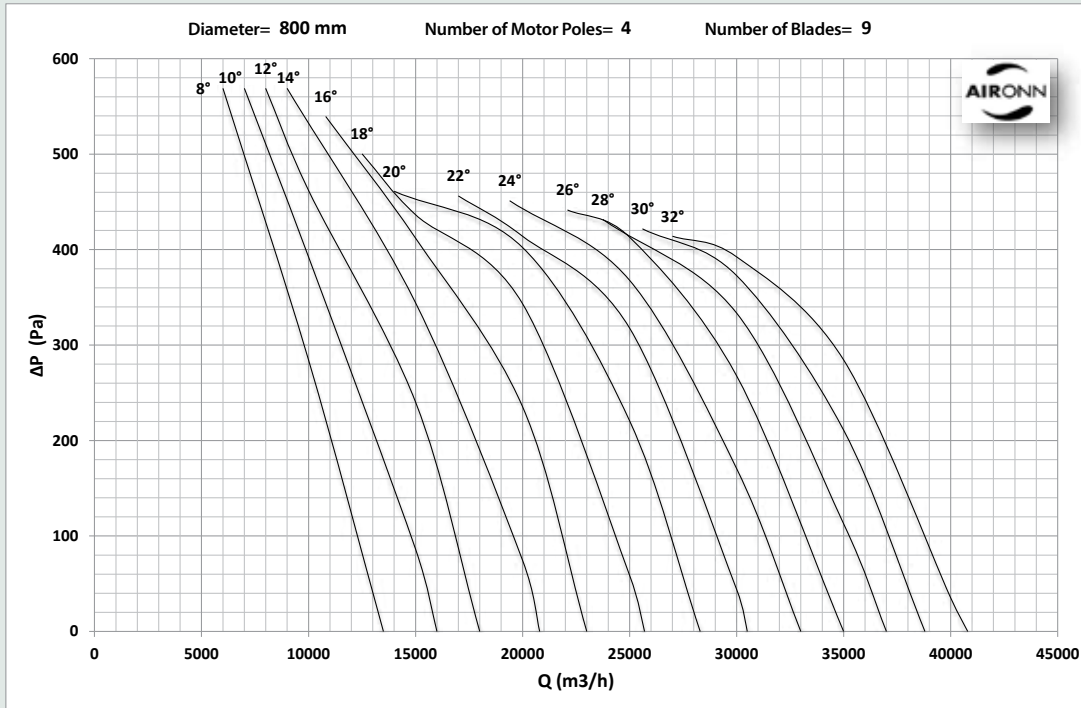

# Axial Hollow Smoke Exhaust Fan Series

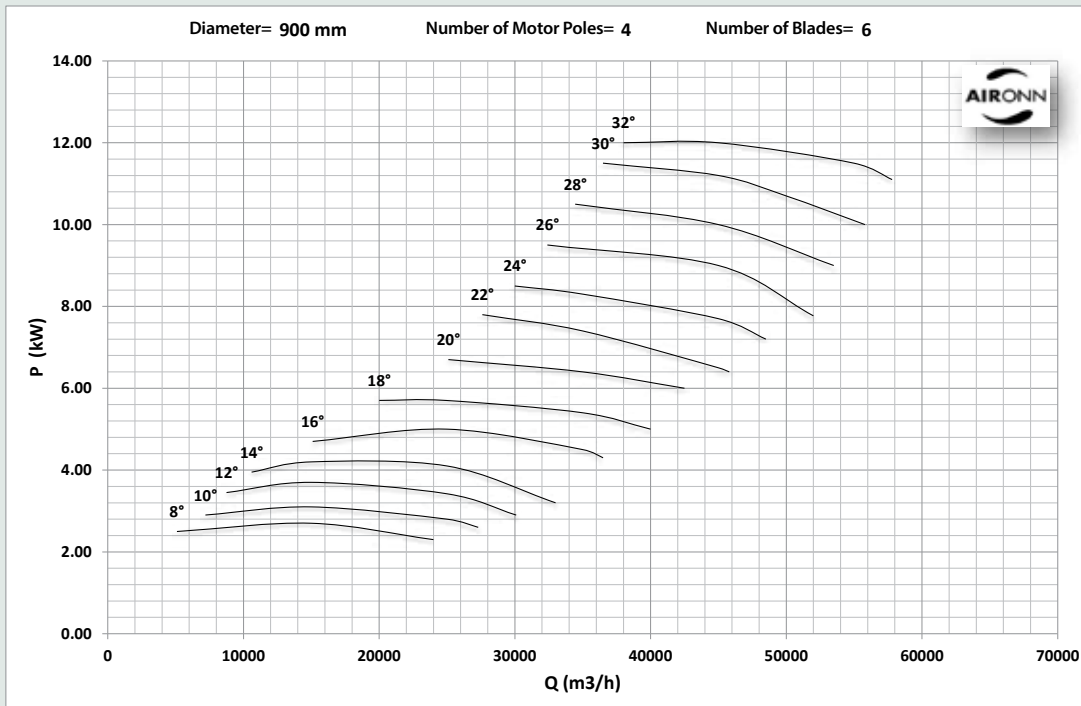
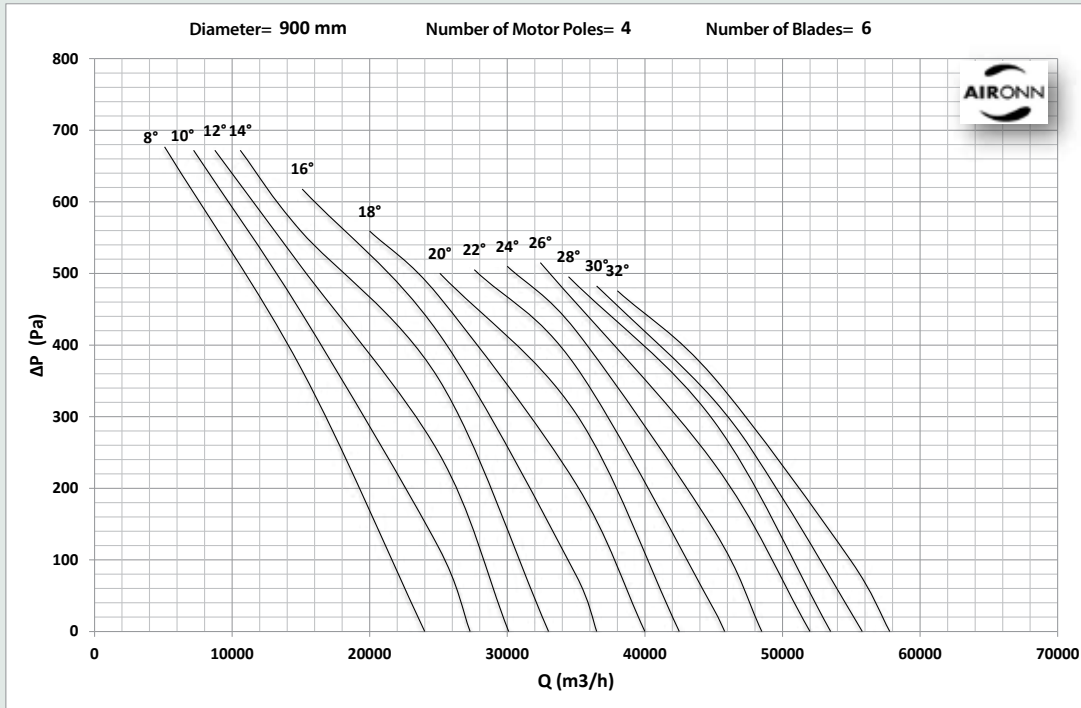

# Axial Hollow Smoke Exhaust Fan Series

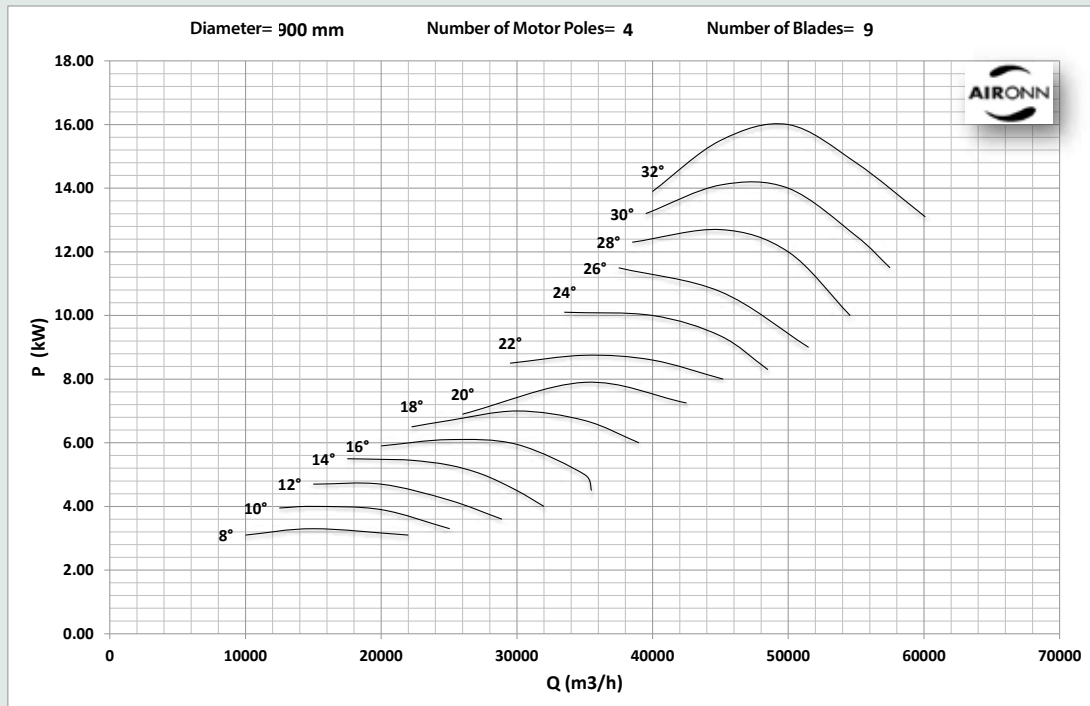
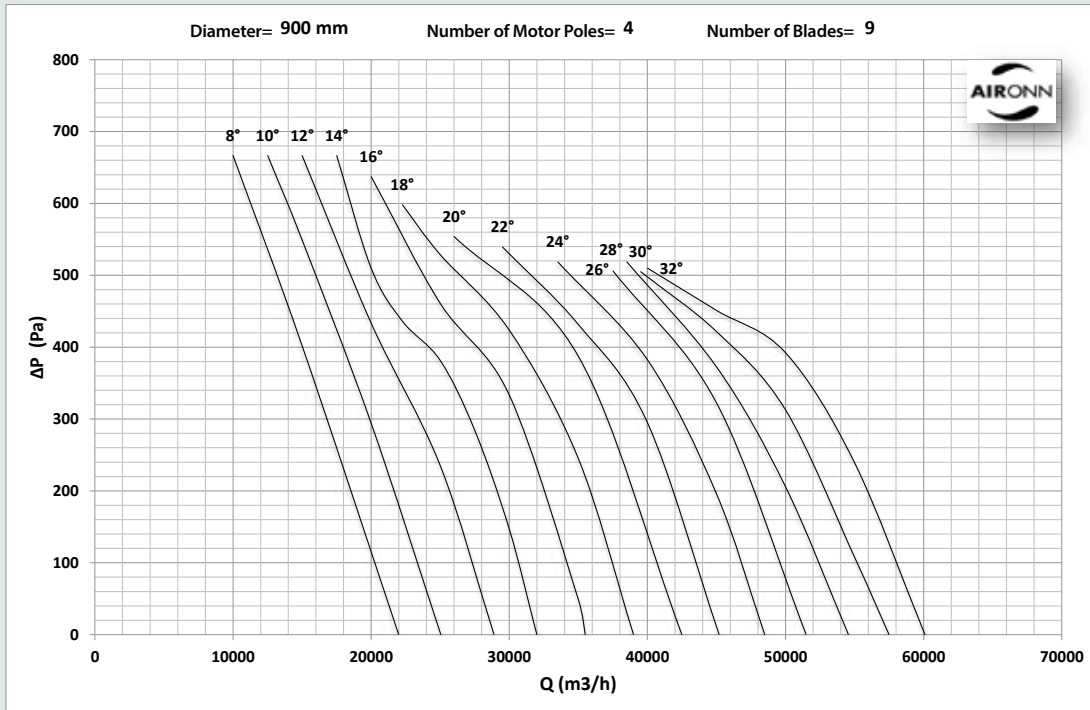

# Axial Hollow Smoke Exhaust Fan Series

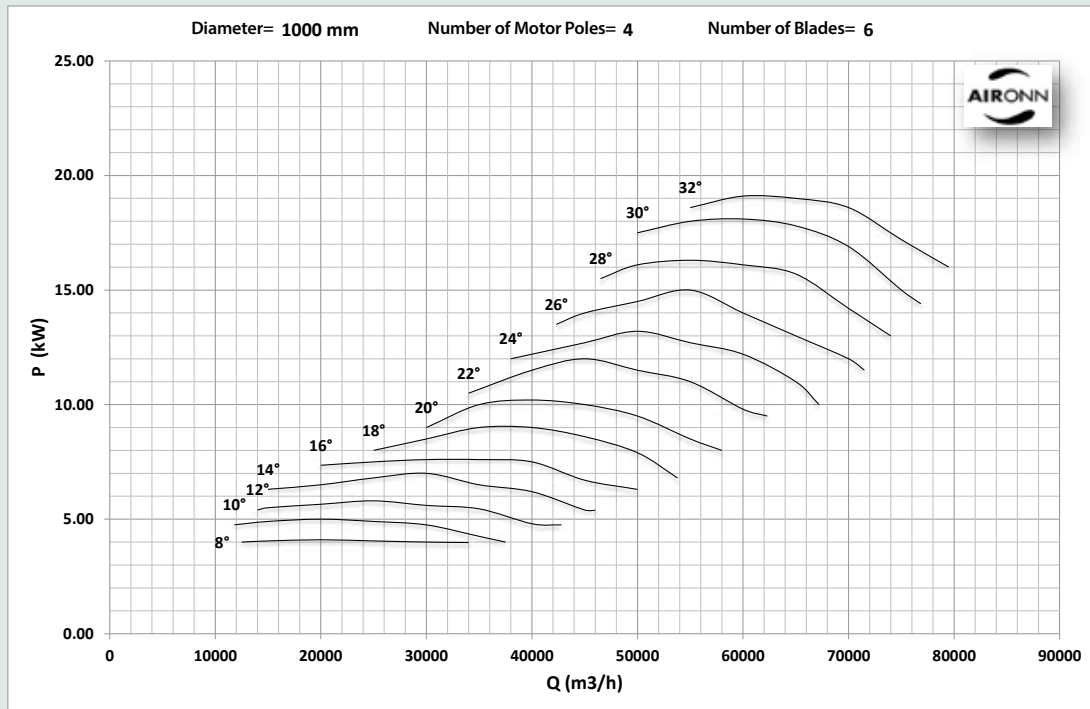
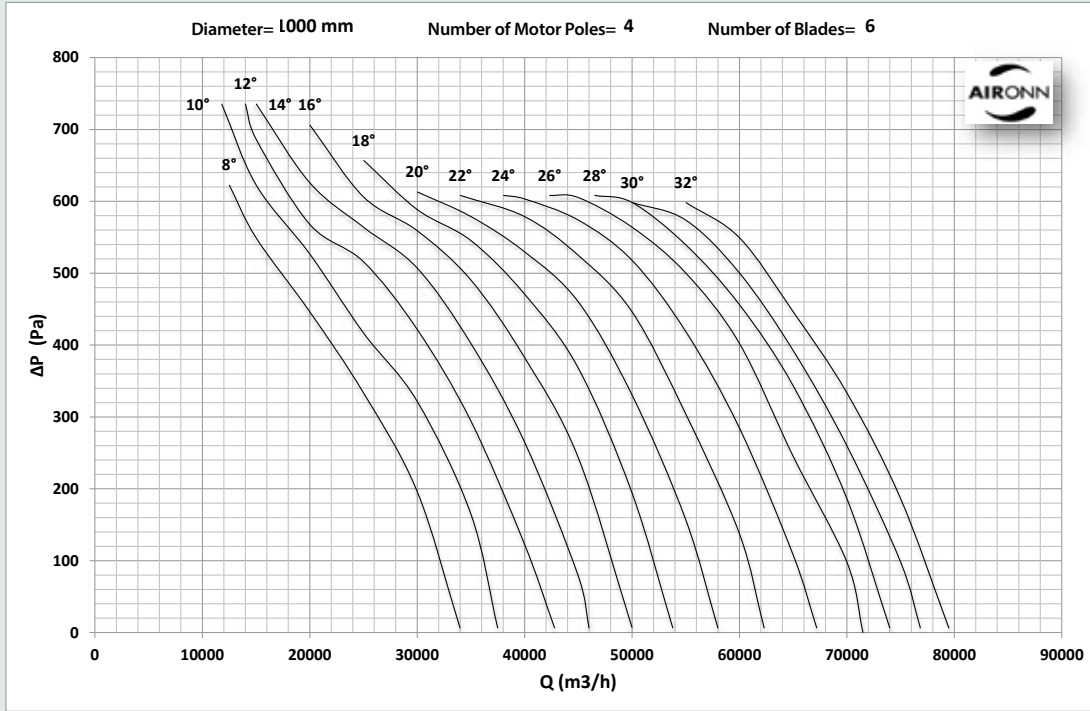

# Axial Hollow Smoke Exhaust Fan Series

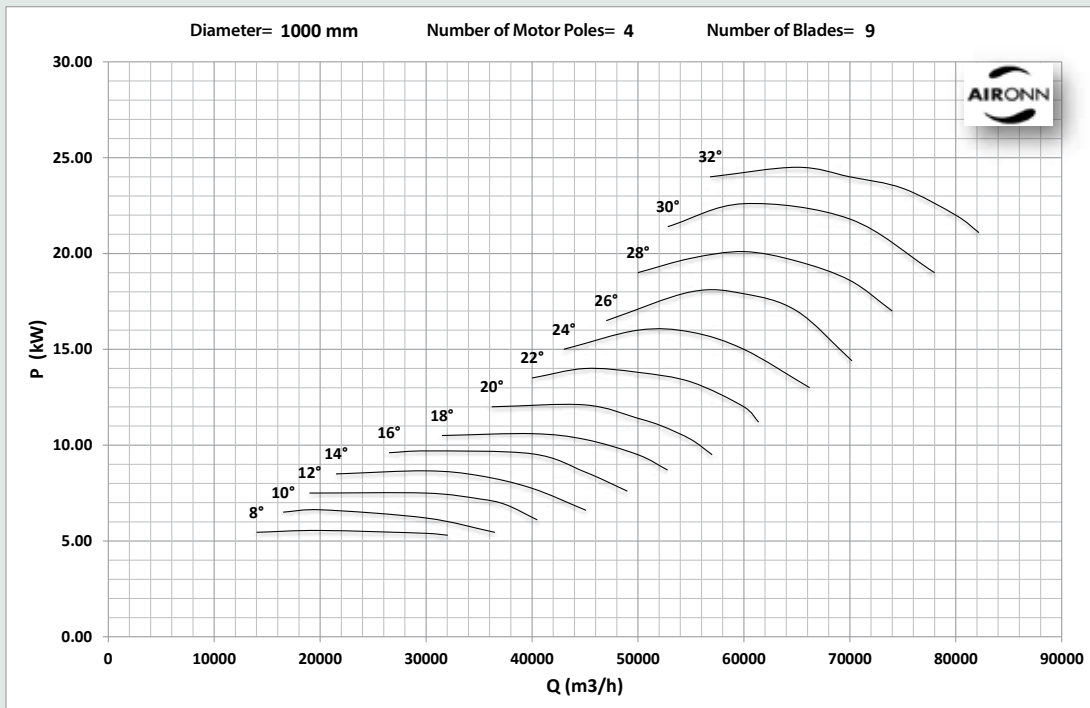
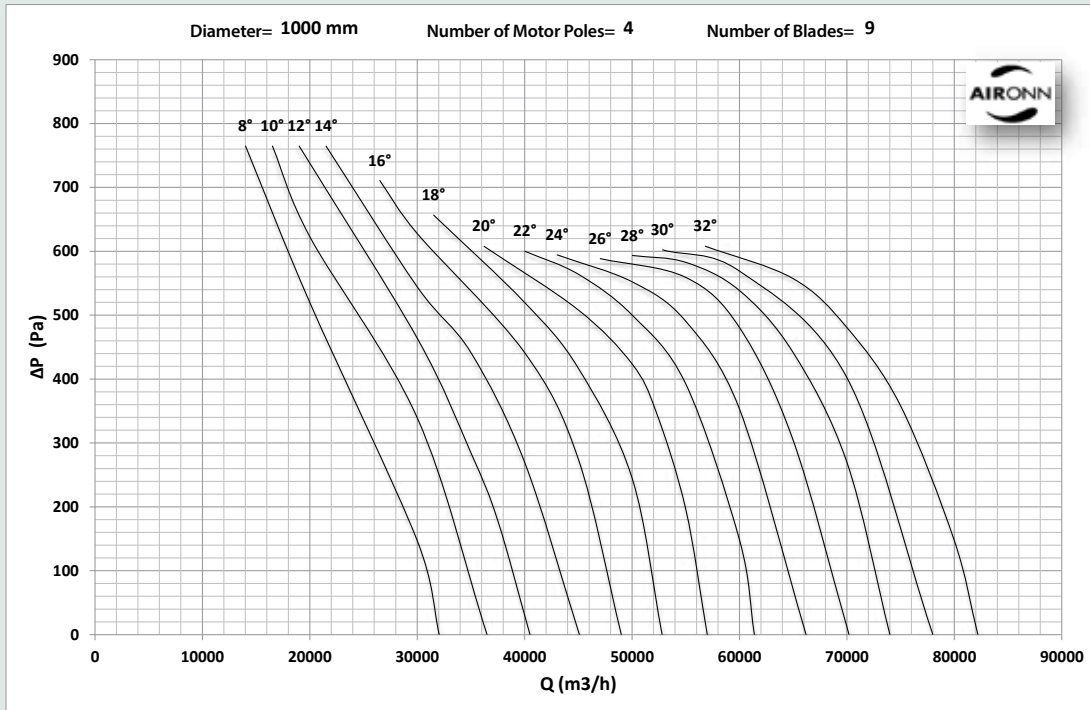

# Axial Hollow Smoke Exhaust Fan Series

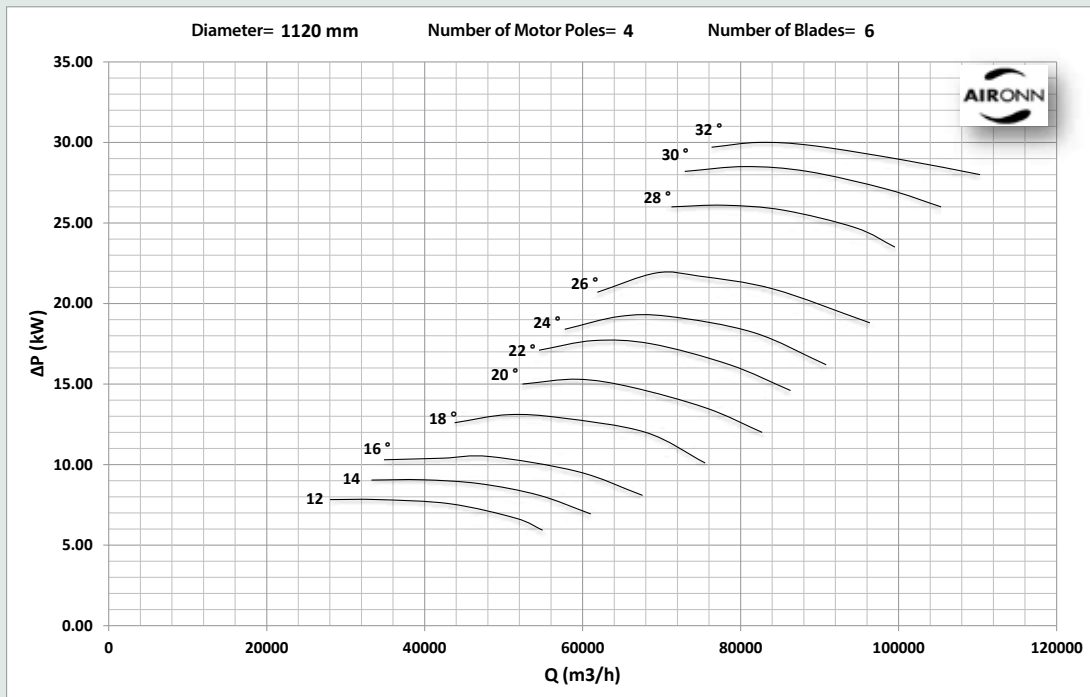
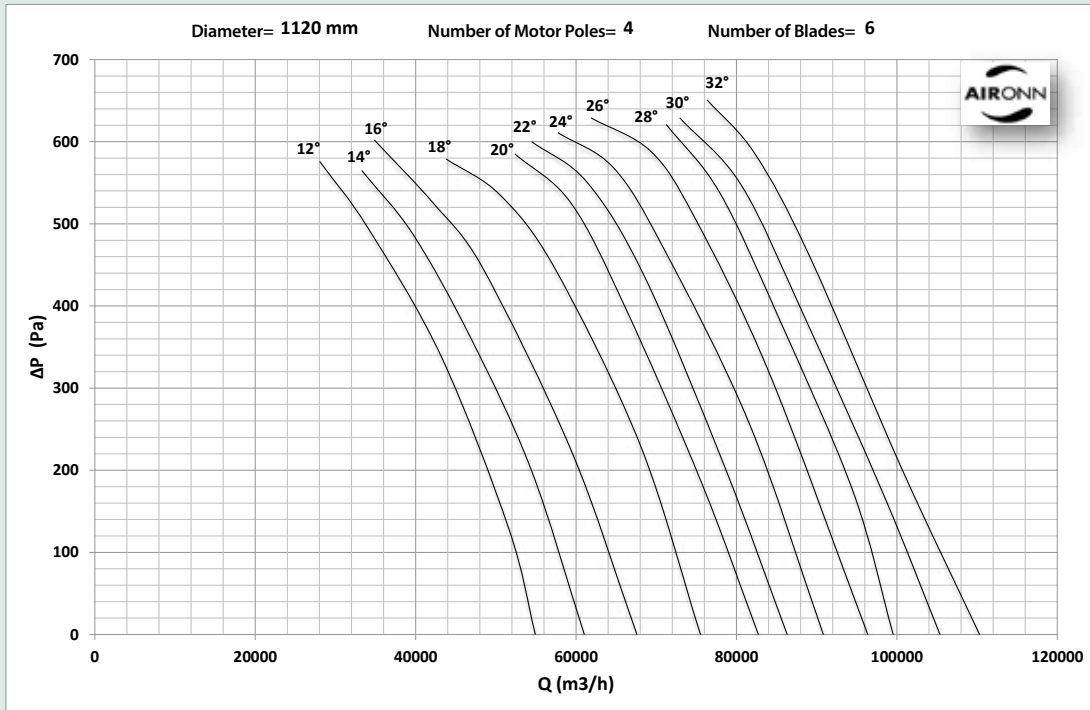

# Axial Hollow Smoke Exhaust Fan Series

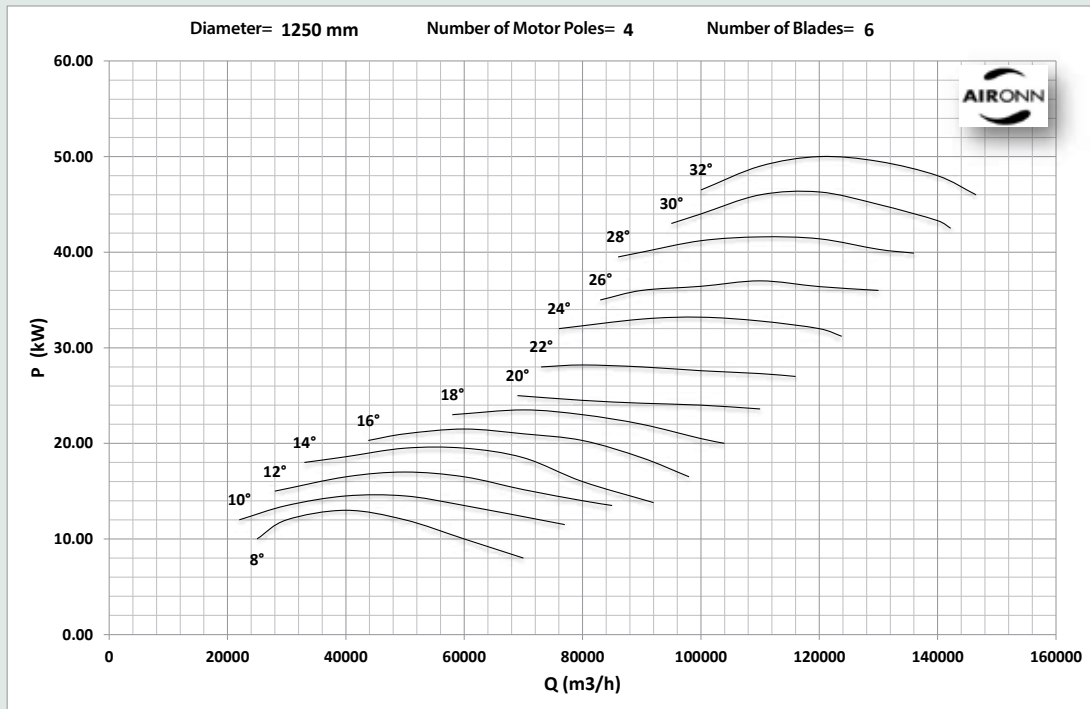
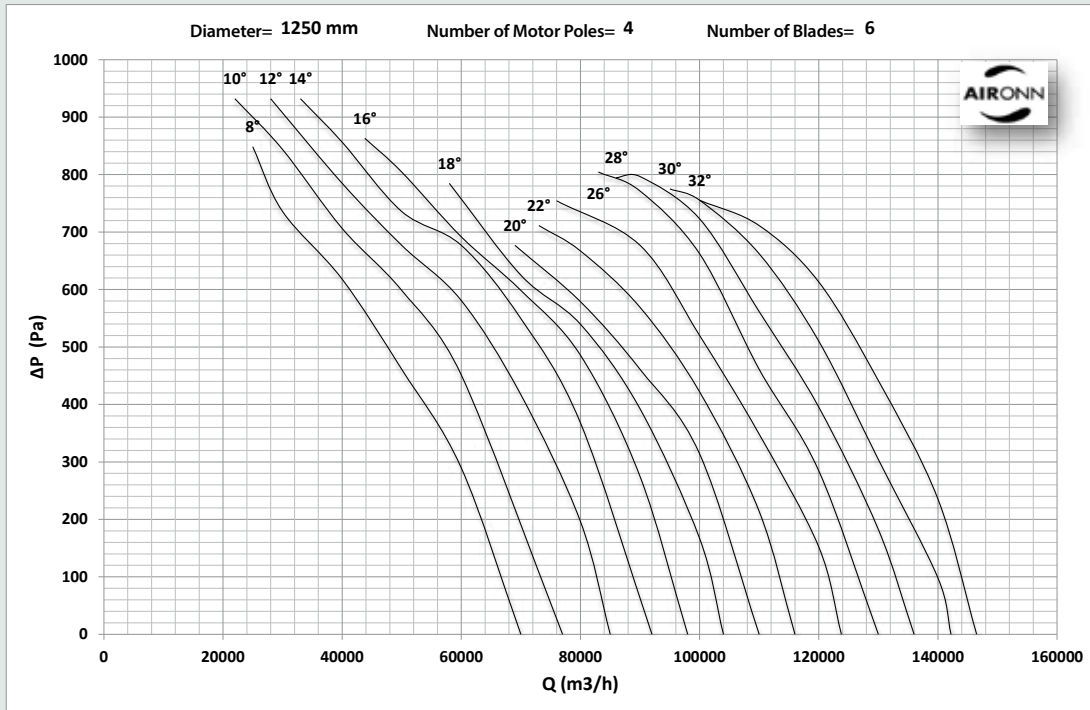



# Axial Hollow Smoke Exhaust Fan Series

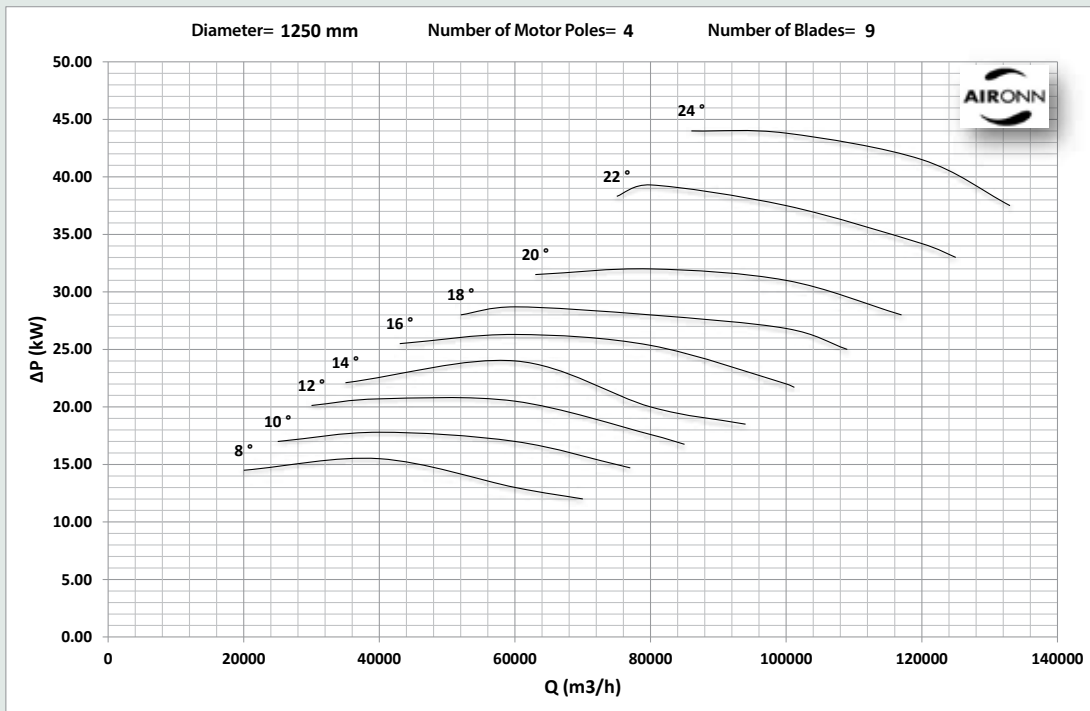
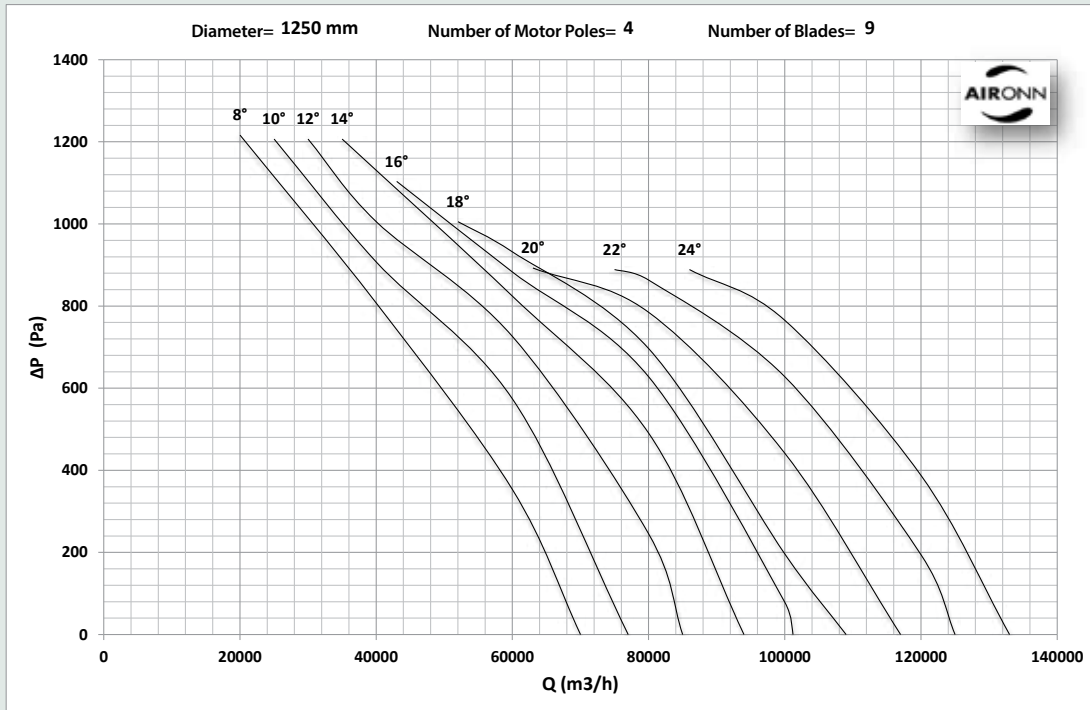

# Axial Hollow Smoke Exhaust Fan Series

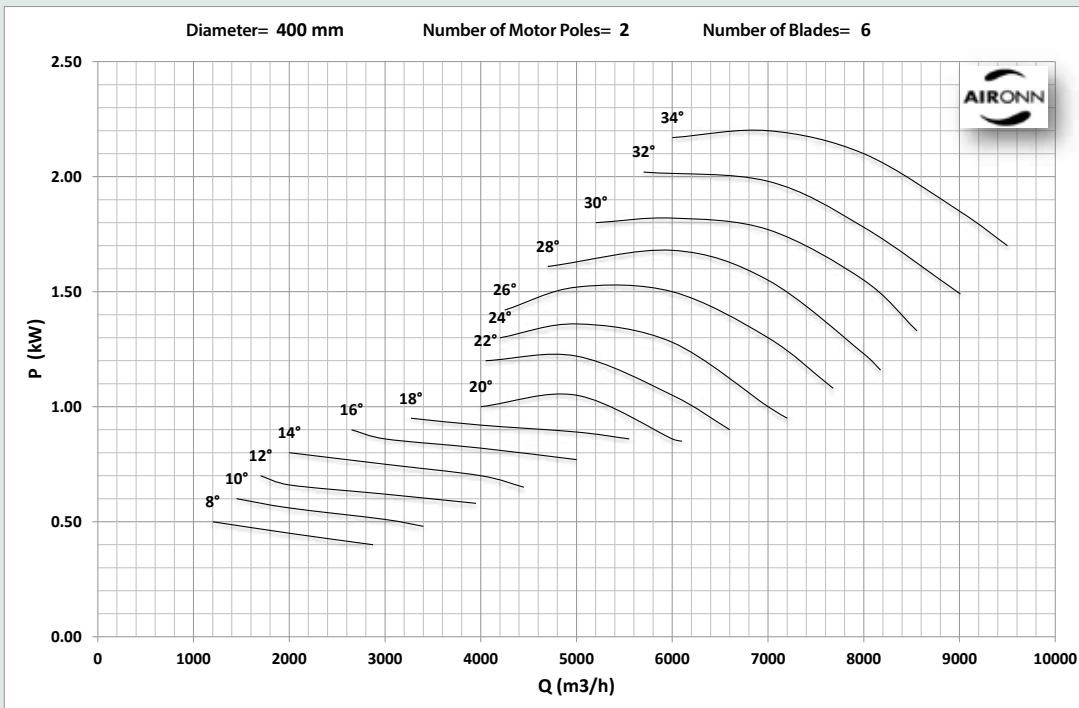
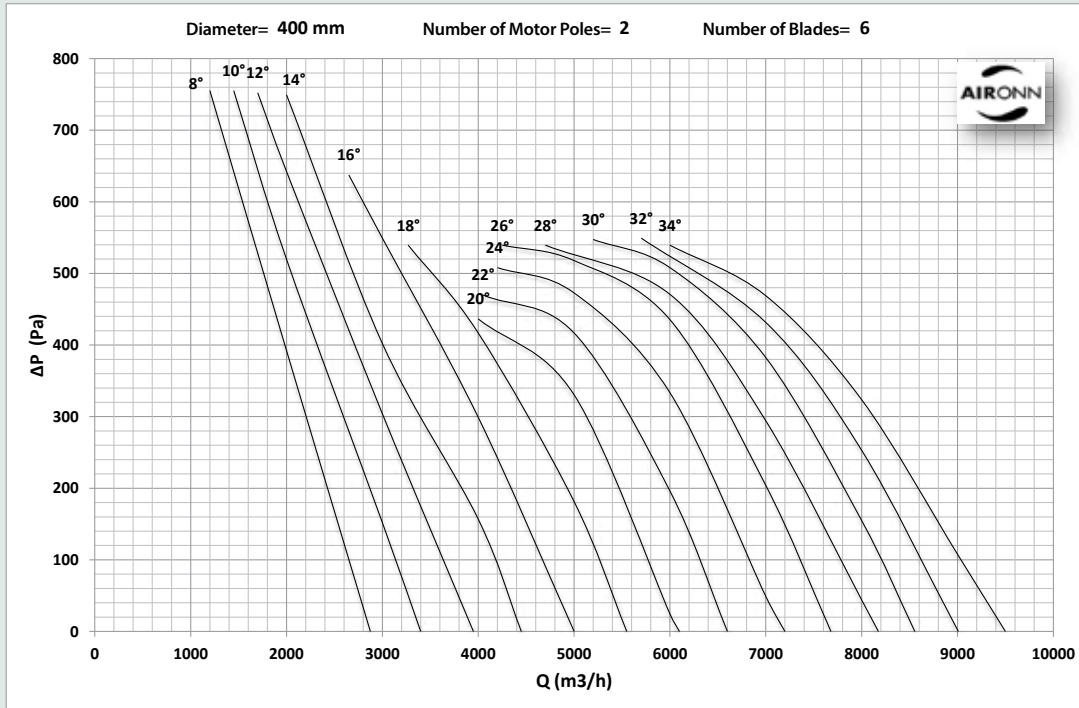

# Axial Hollow Smoke Exhaust Fan Series

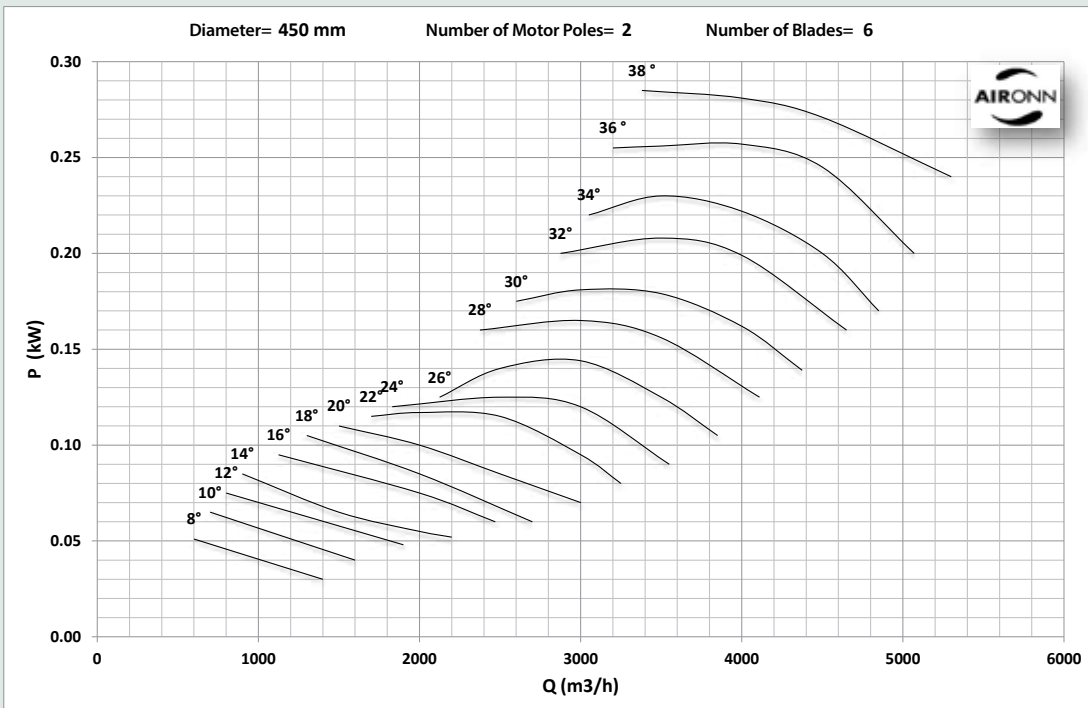
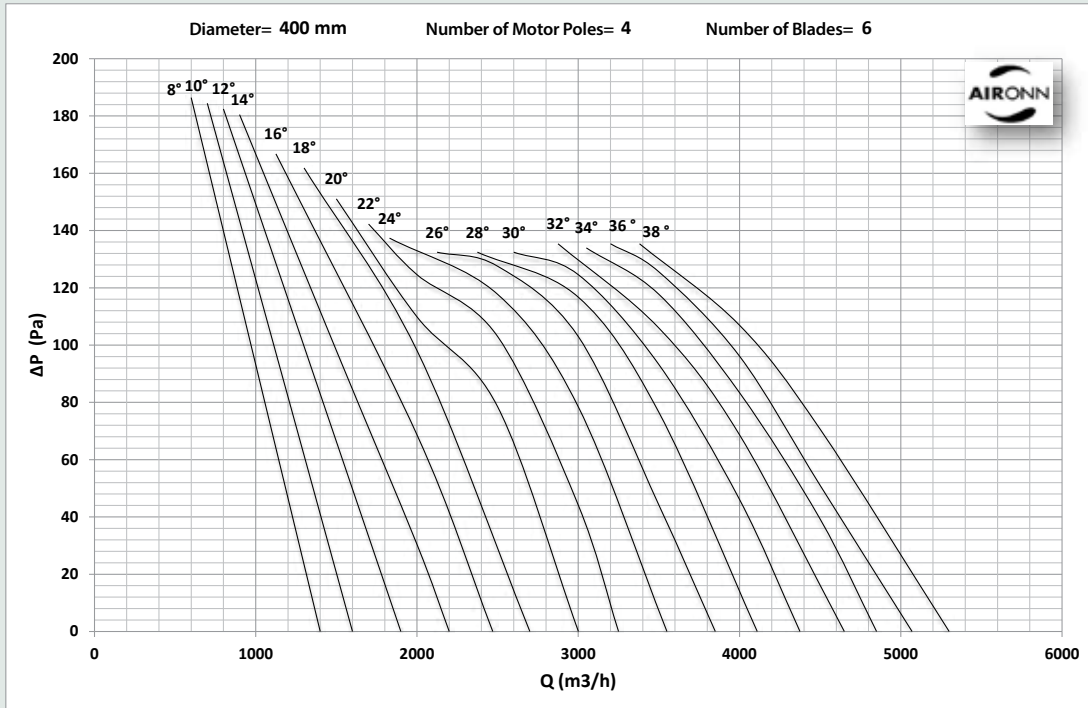

# Axial Hollow Smoke Exhaust Fan Series

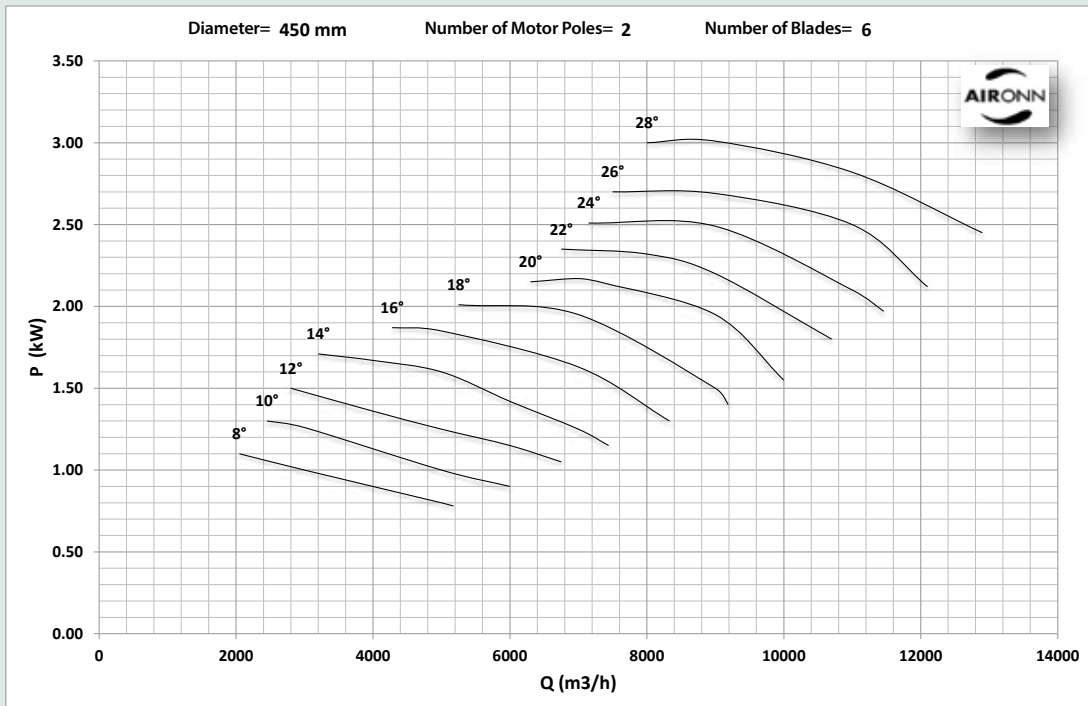
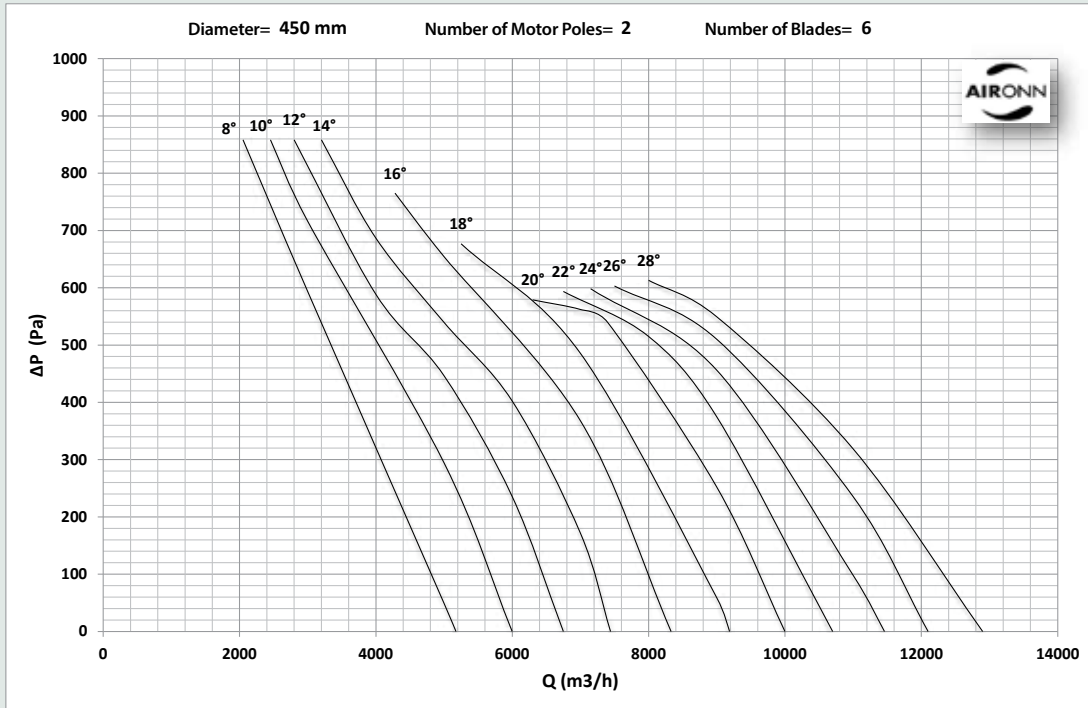

# Axial Hollow Smoke Exhaust Fan Series

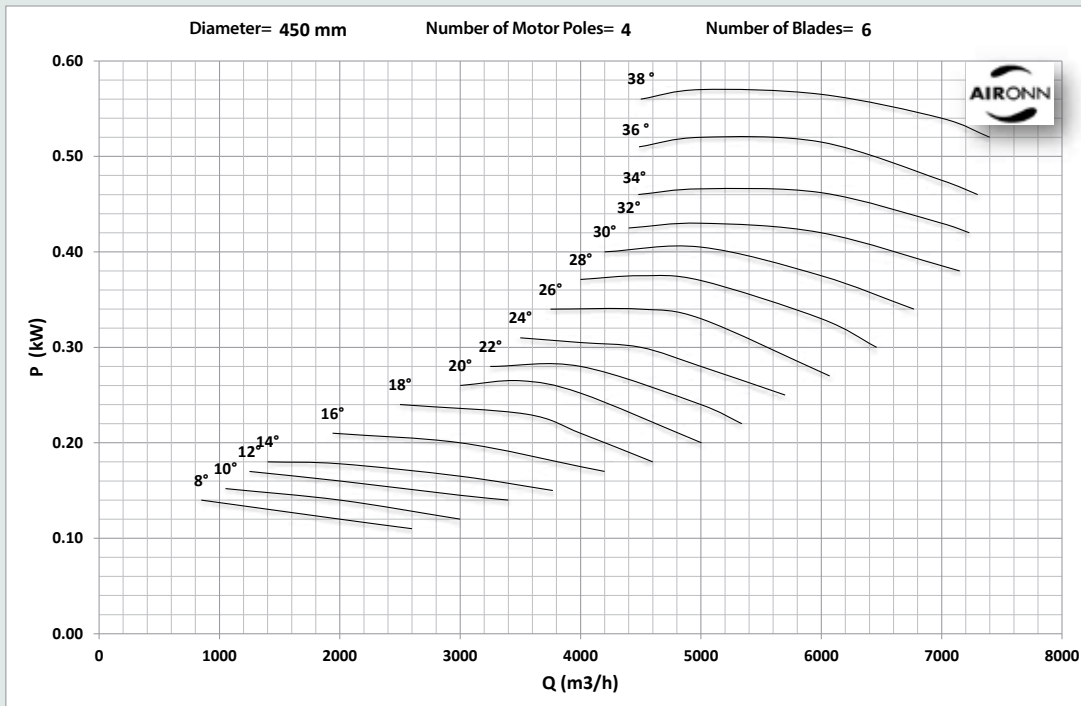
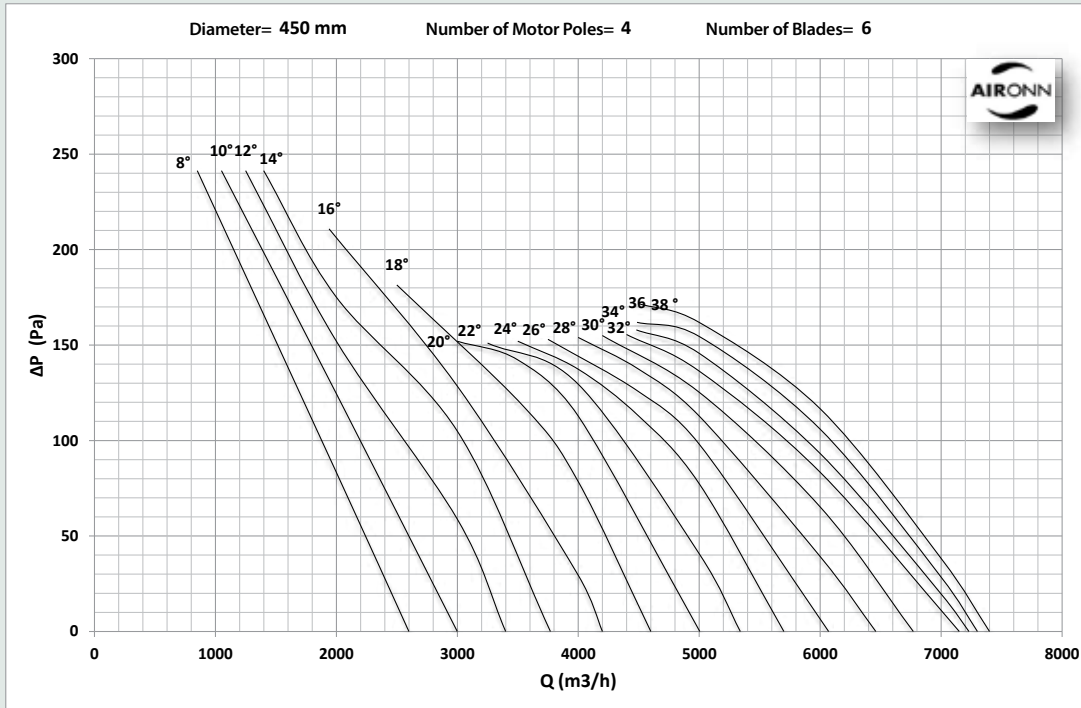

# Axial Hollow Smoke Exhaust Fan Series

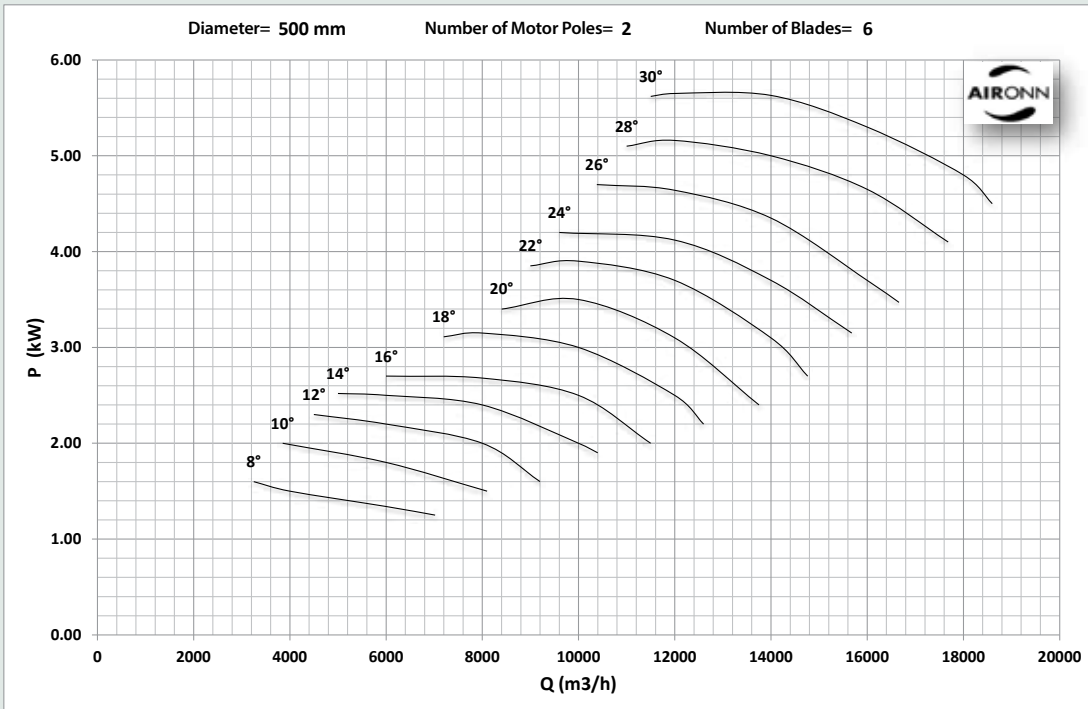
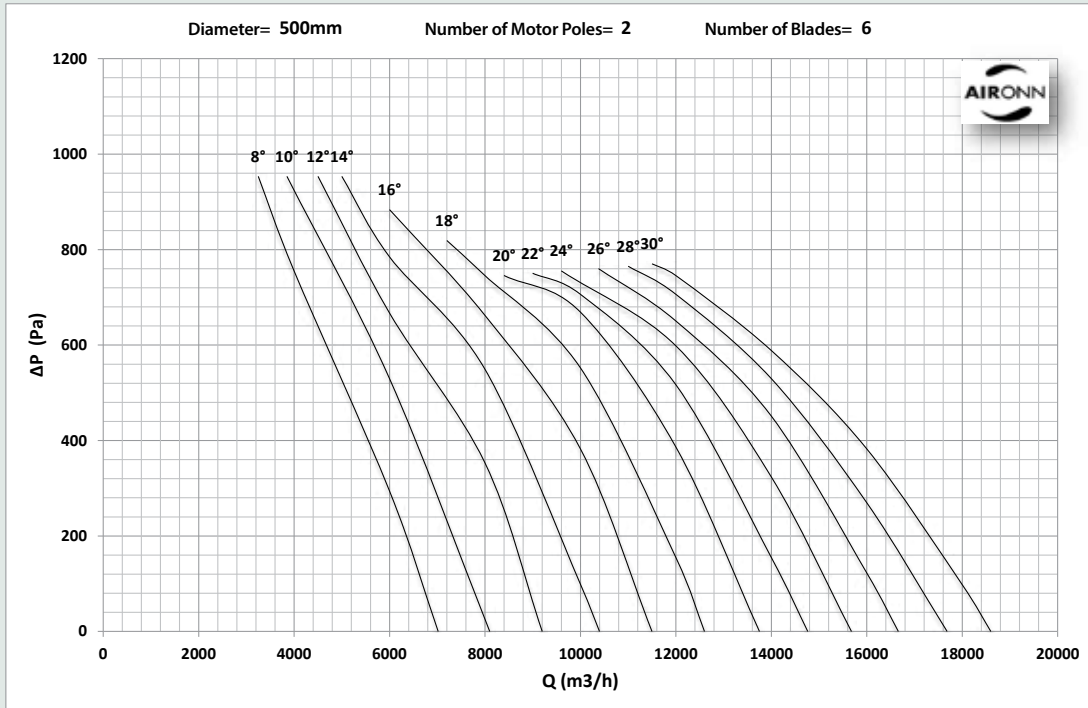

# Axial Hollow Smoke Exhaust Fan Series

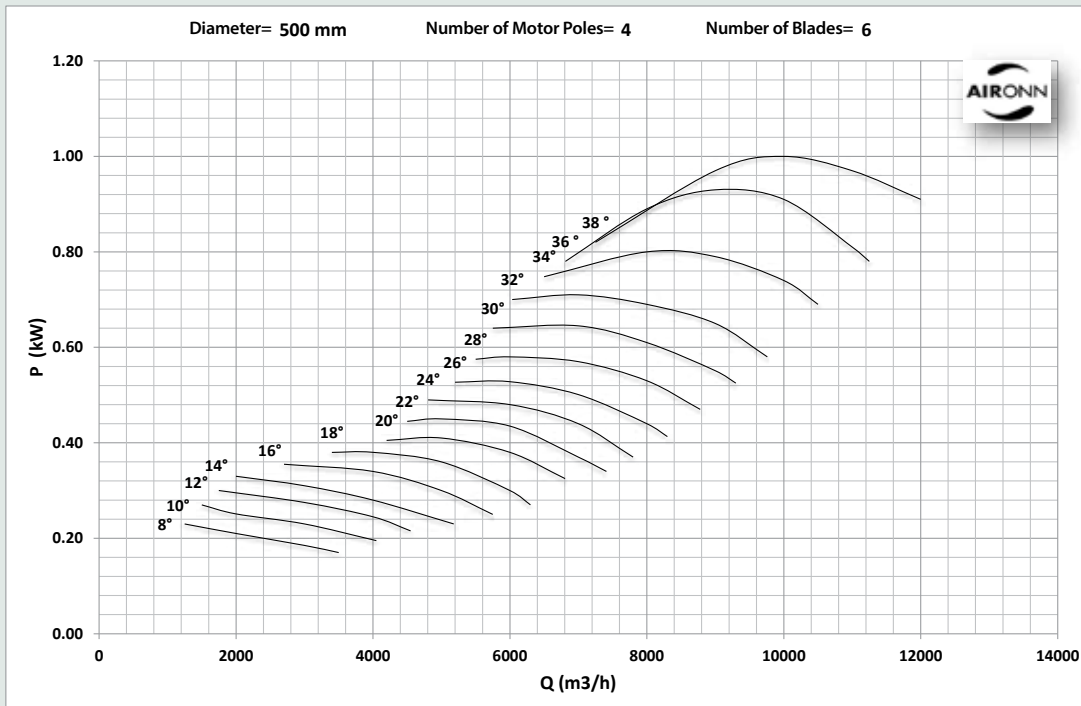
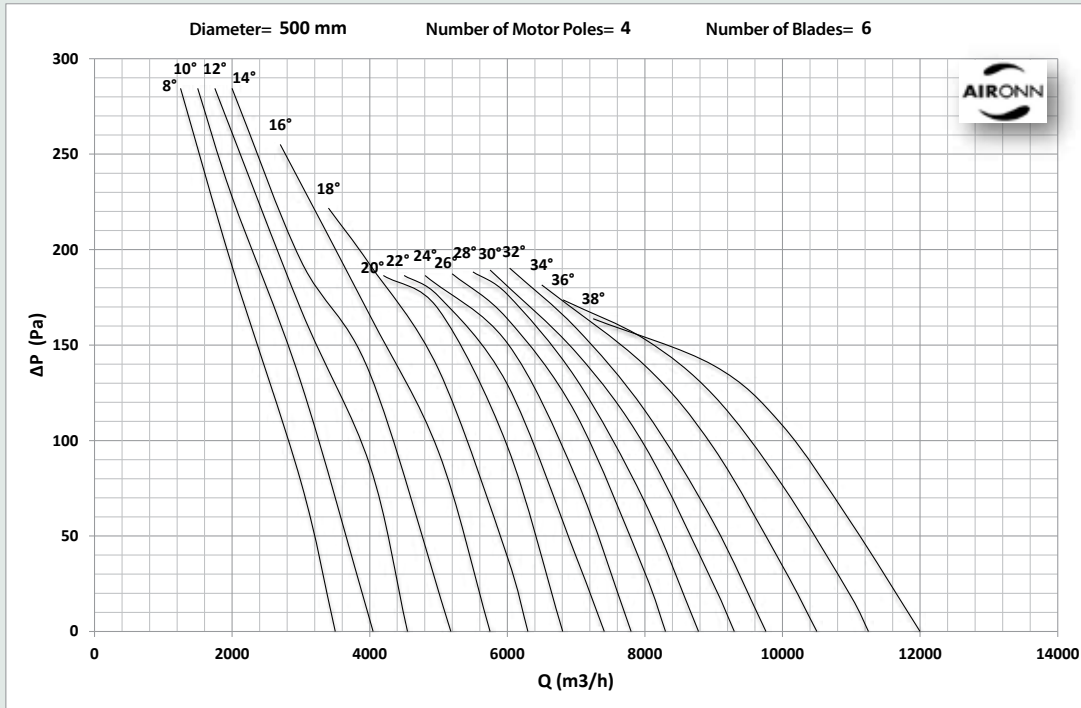

# Axial Hollow Smoke Exhaust Fan Series

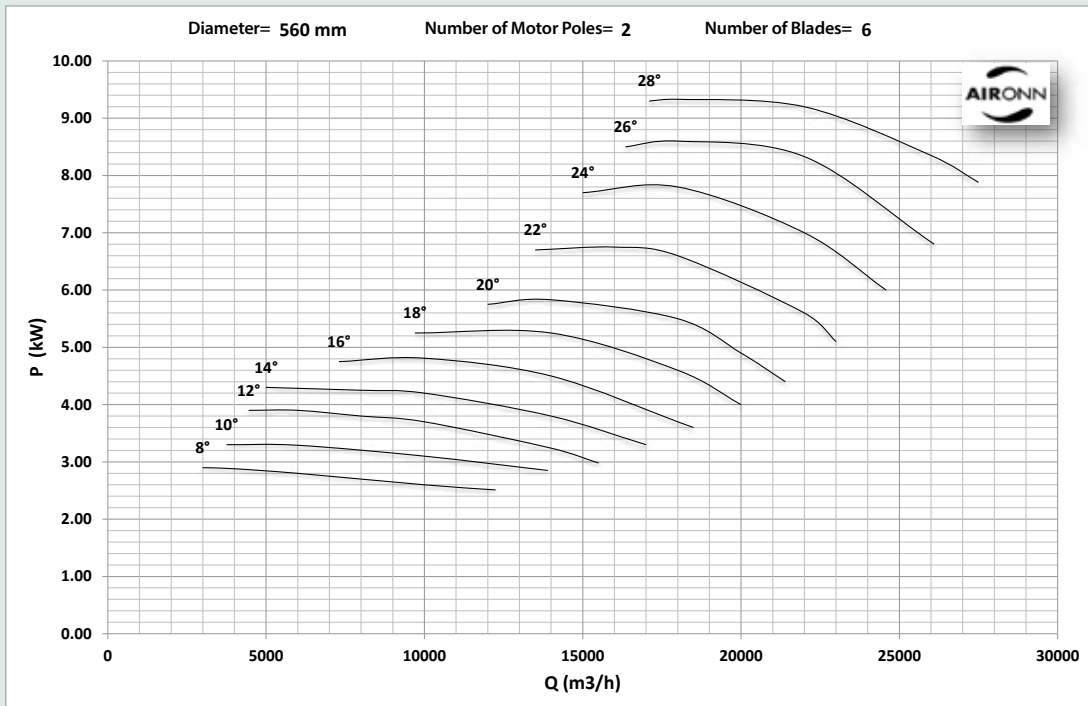
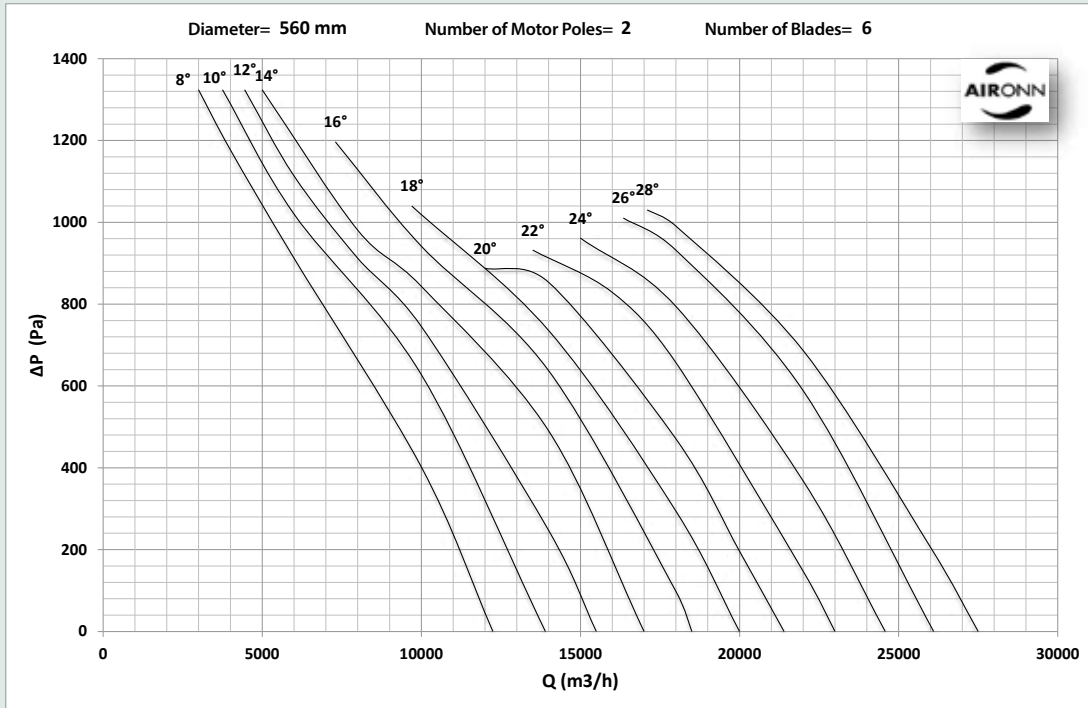



# Axial Hollow Smoke Exhaust Fan Series

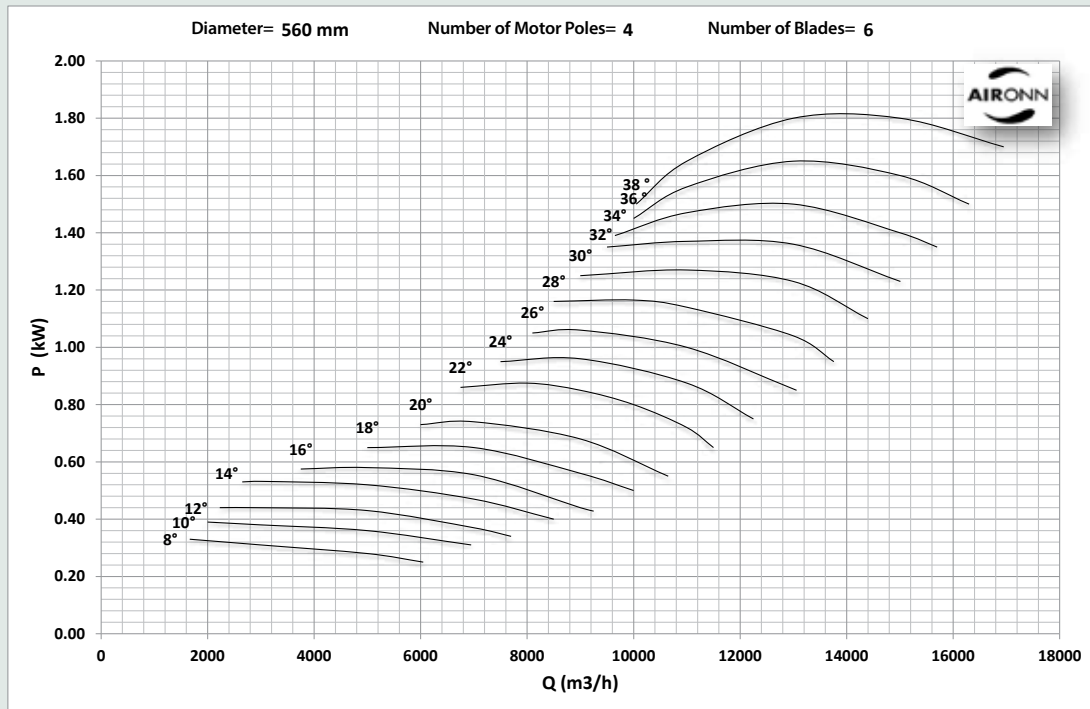
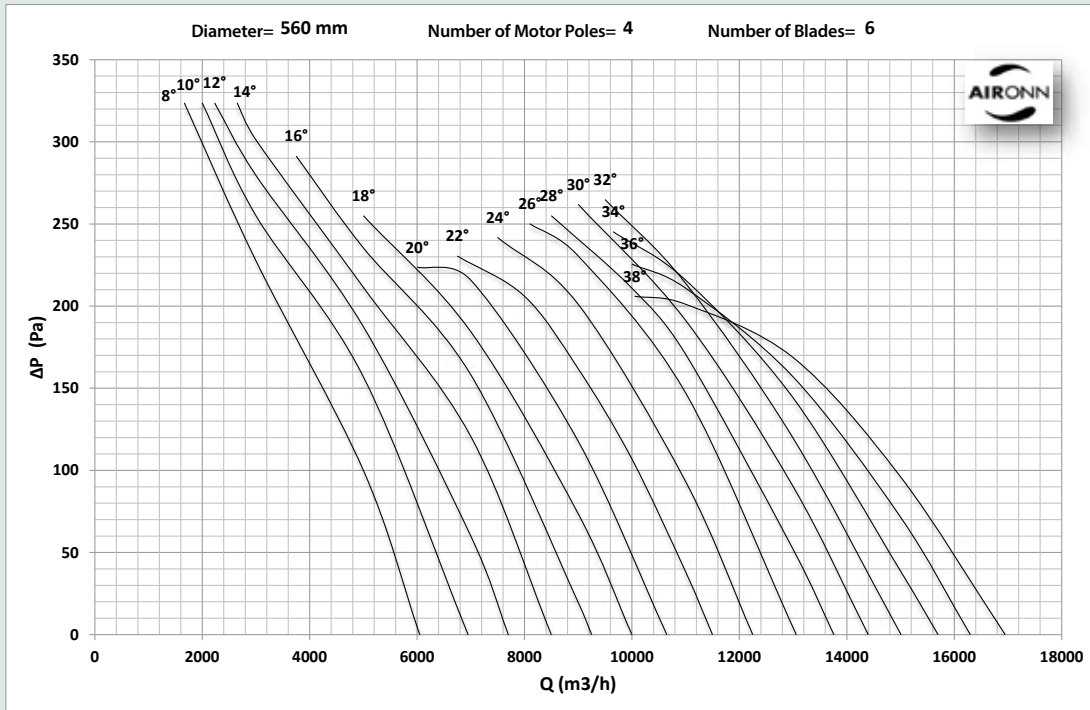

# Axial Hollow Smoke Exhaust Fan Series

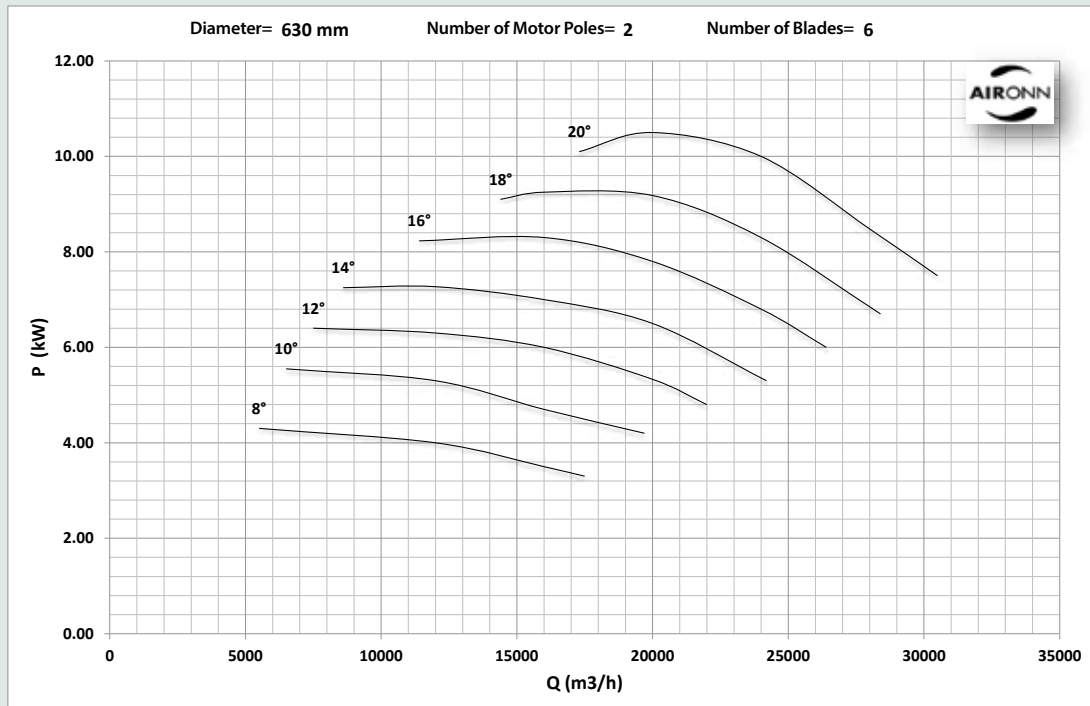
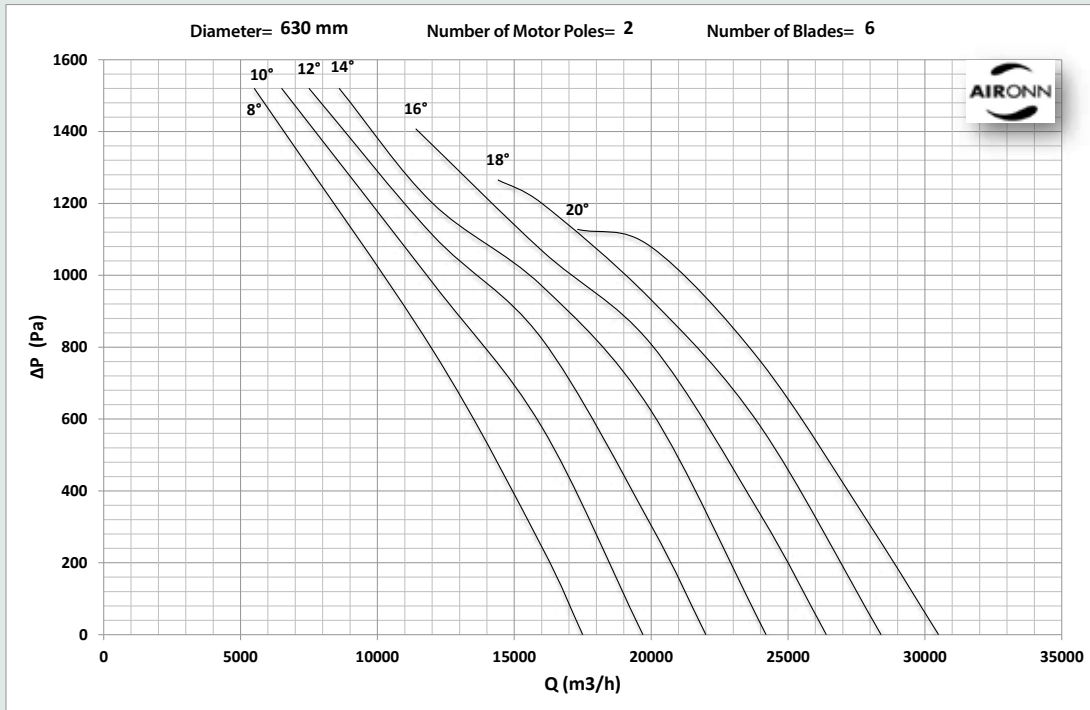

# Axial Hollow Smoke Exhaust Fan Series

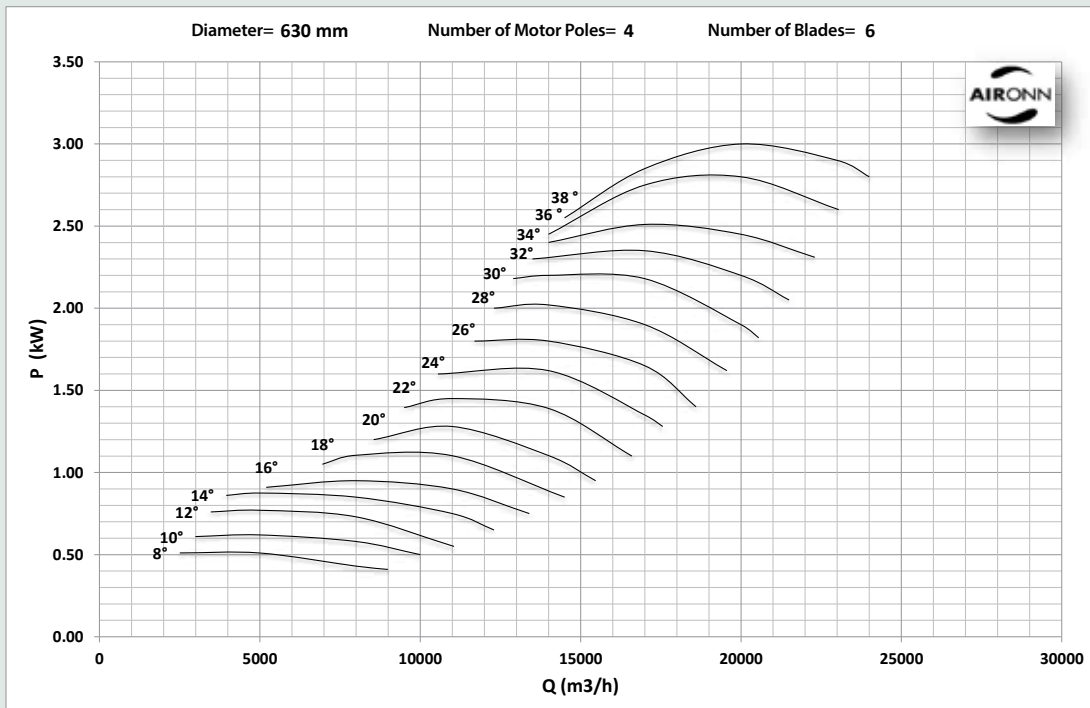
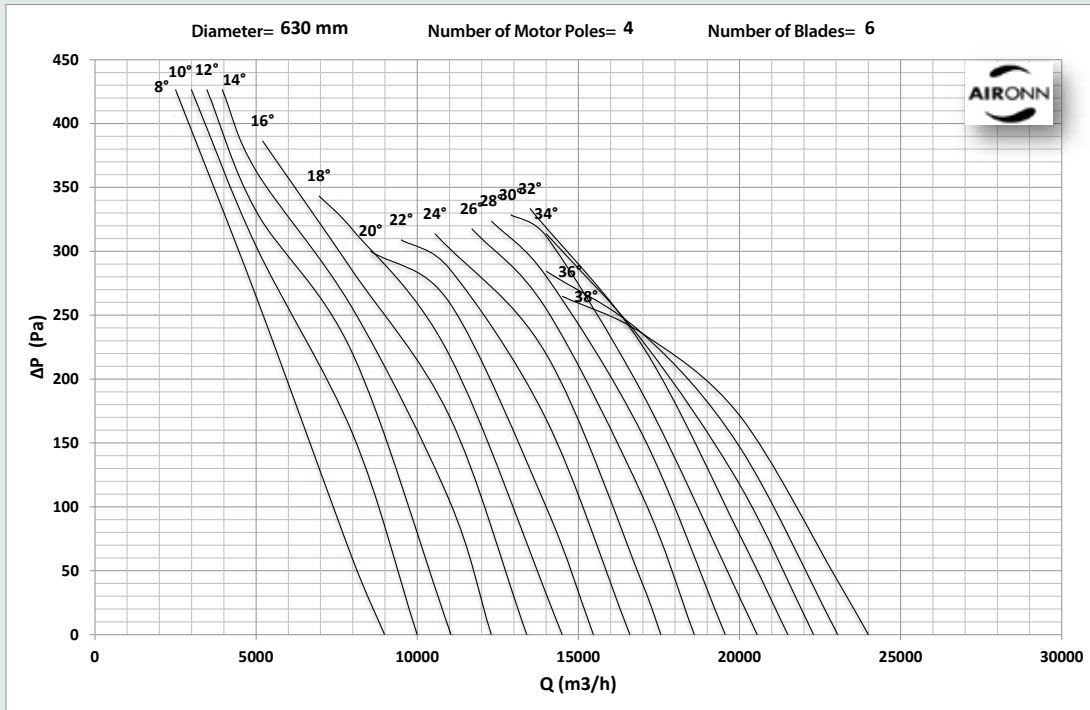

# Axial Hollow Smoke Exhaust Fan Series

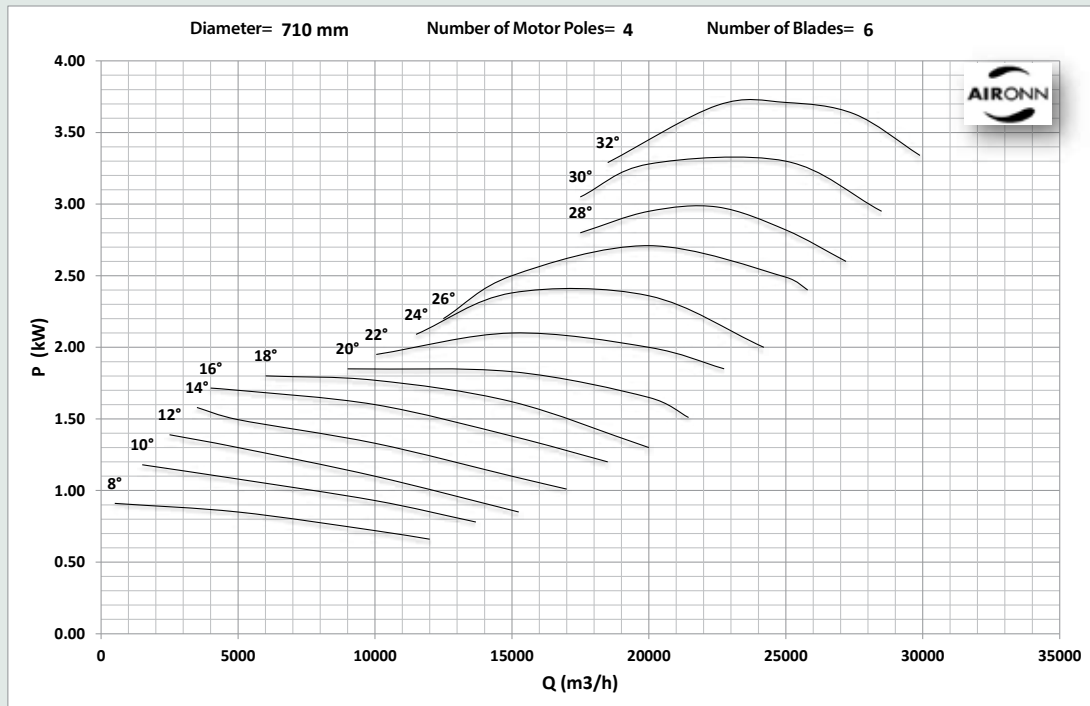
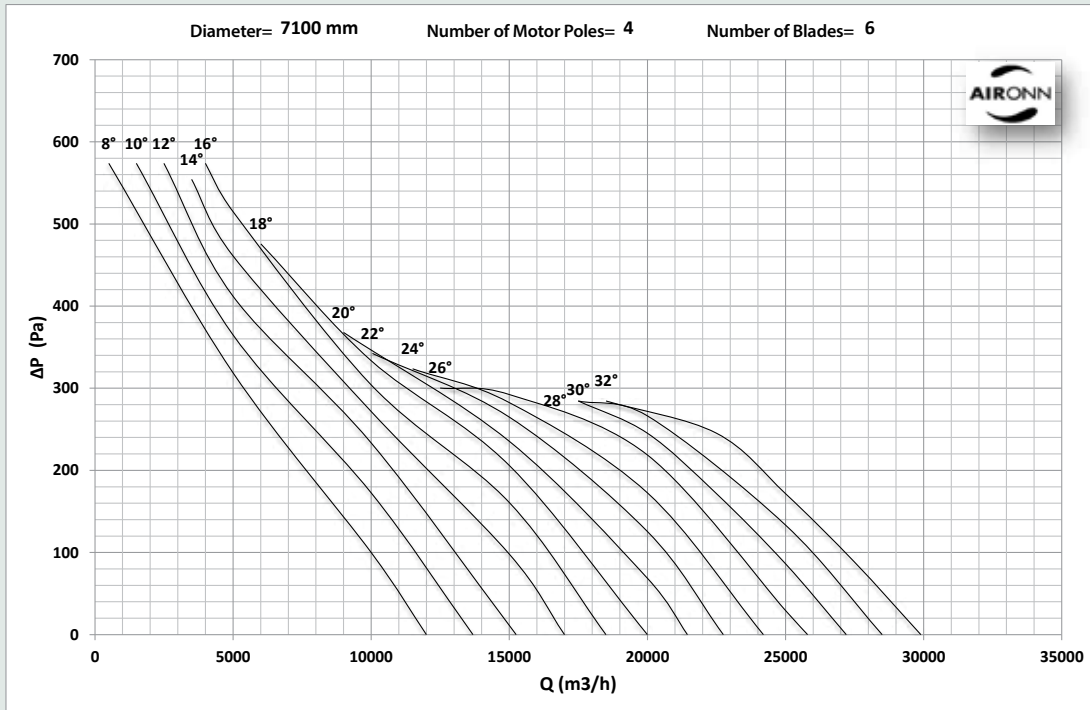

# Axial Hollow Smoke Exhaust Fan Series

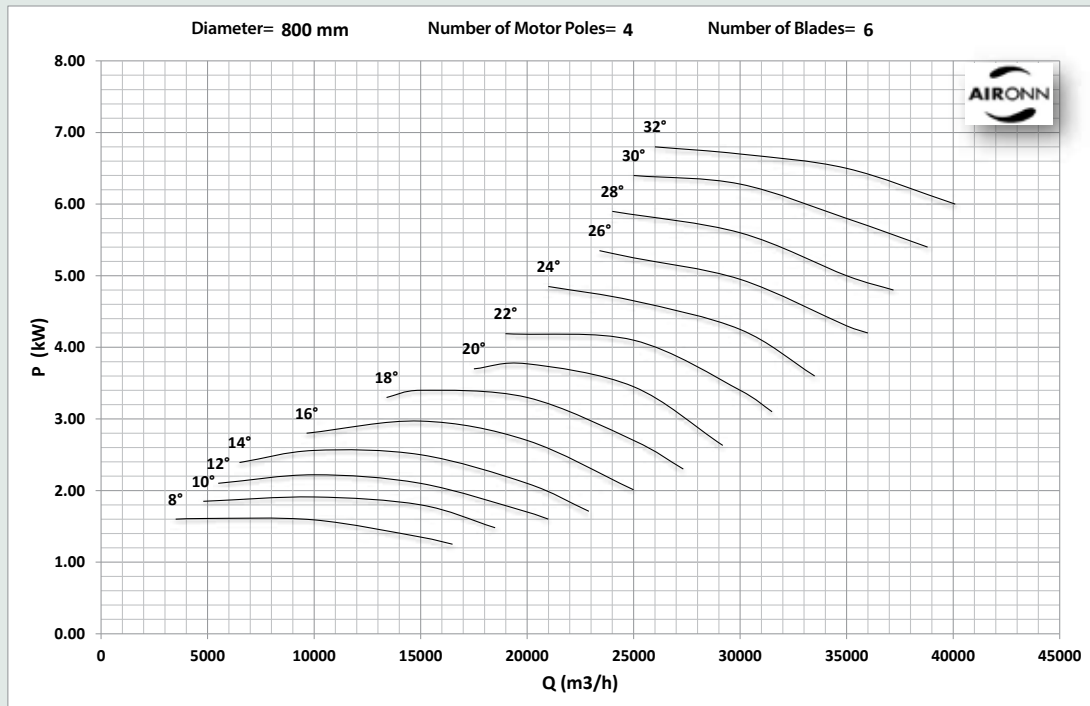
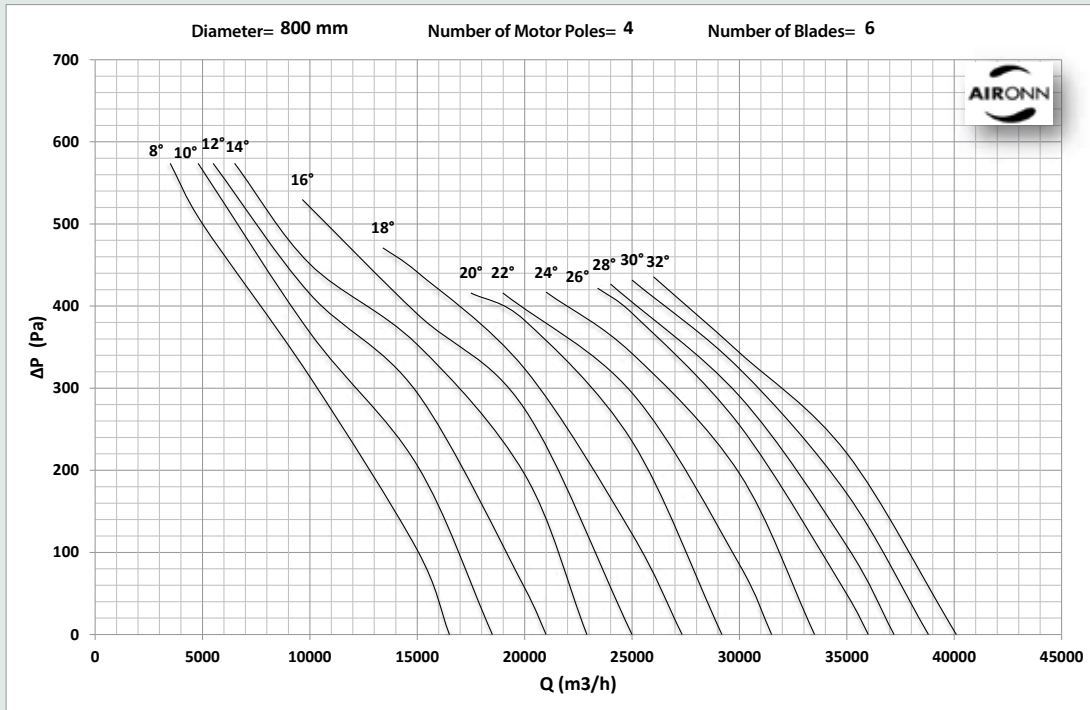

# Axial Hollow Smoke Exhaust Fan Series

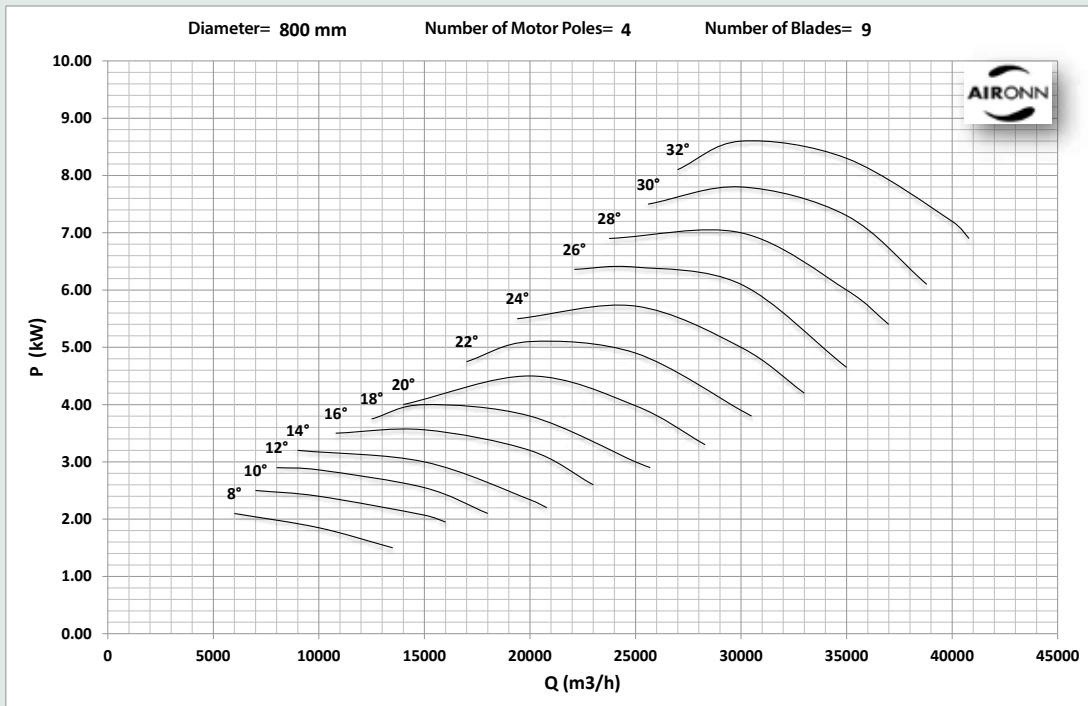
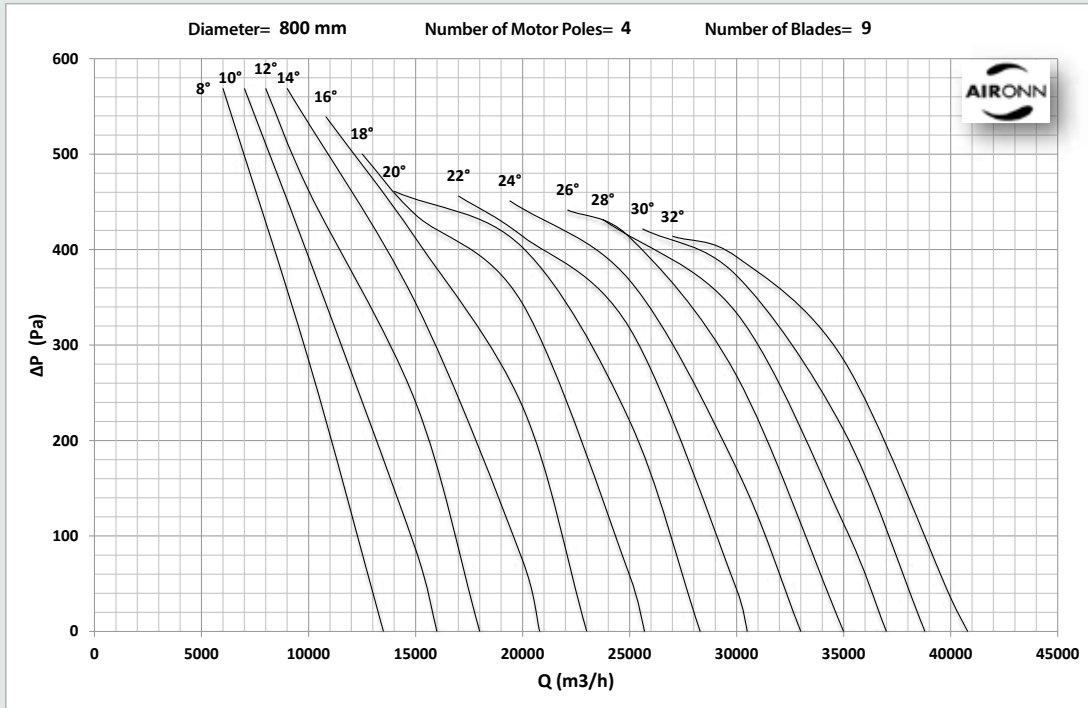

# Axial Hollow Smoke Exhaust Fan Series

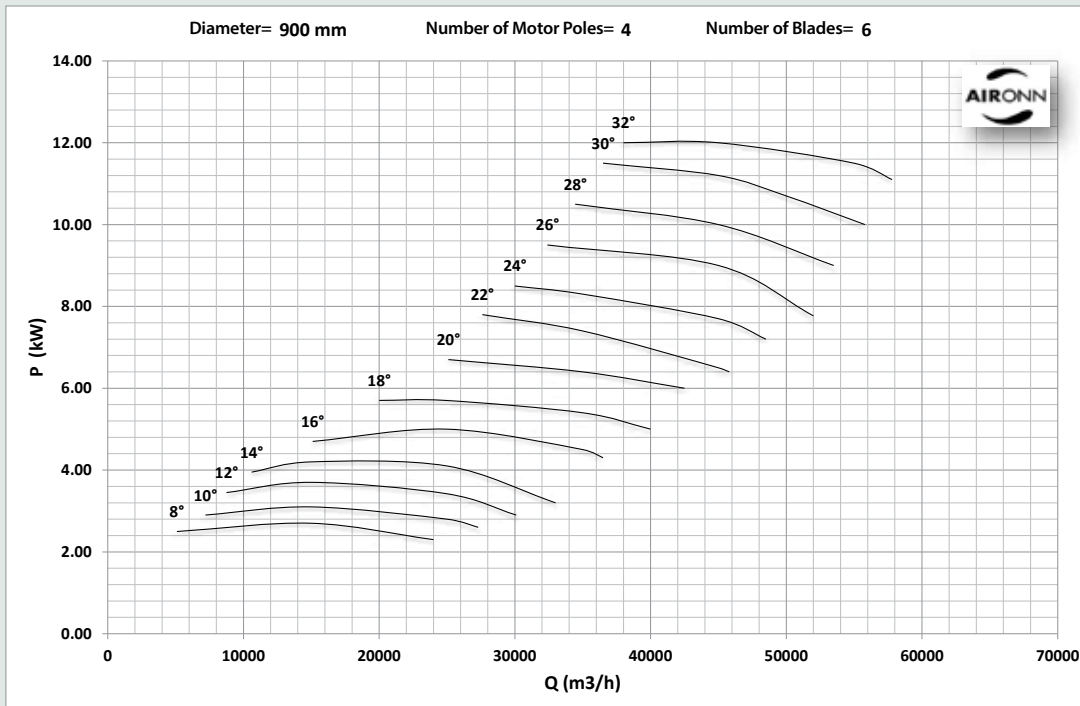
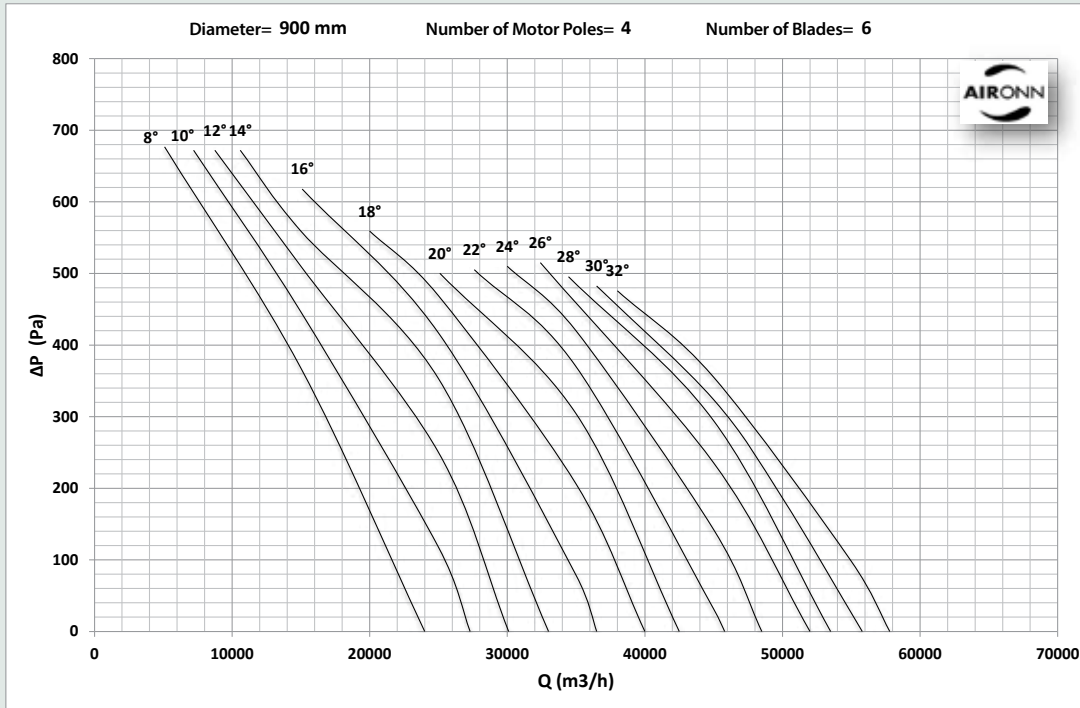

# Axial Hollow Smoke Exhaust Fan Series

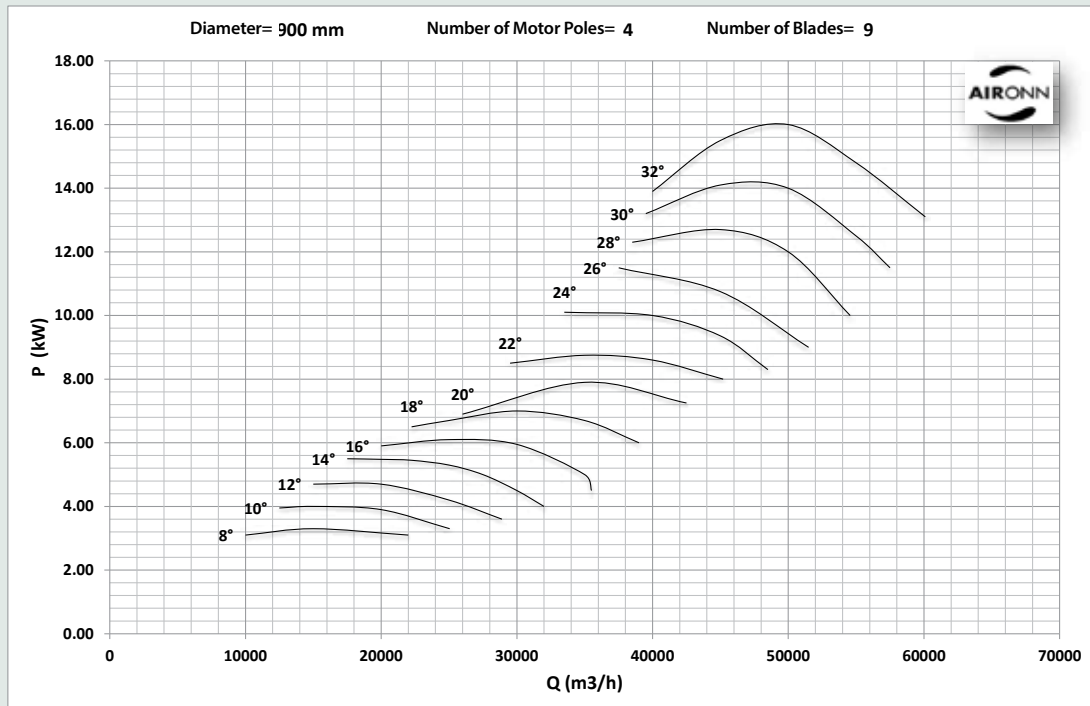
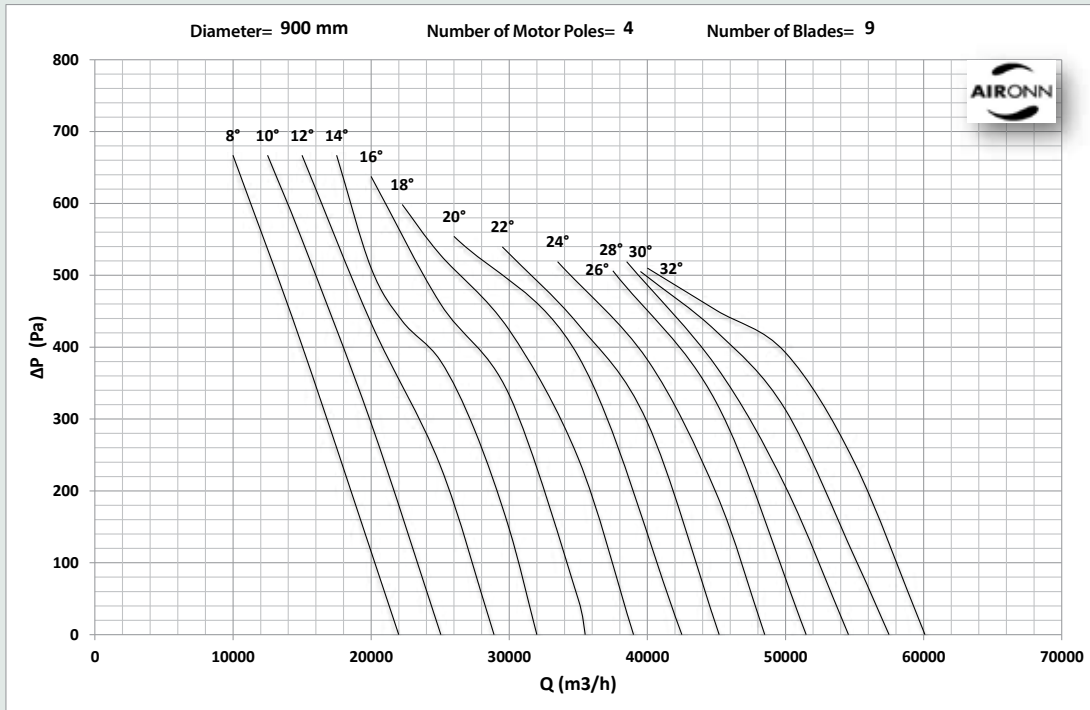



# Axial Hollow Smoke Exhaust Fan Series

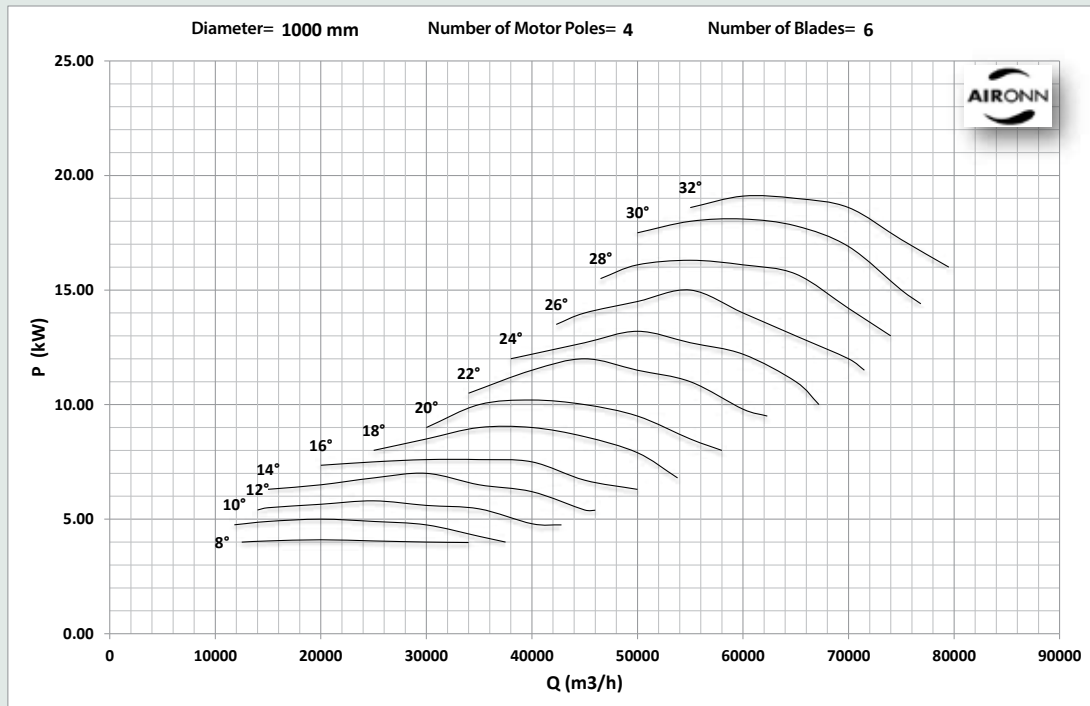
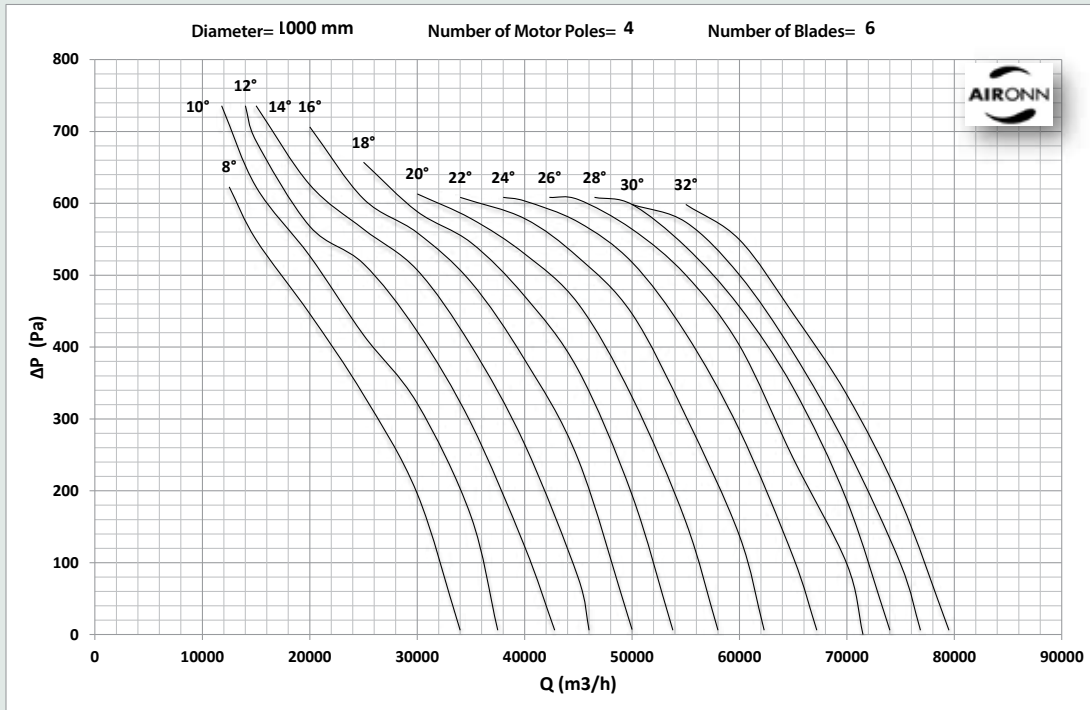

# Axial Hollow Smoke Exhaust Fan Series

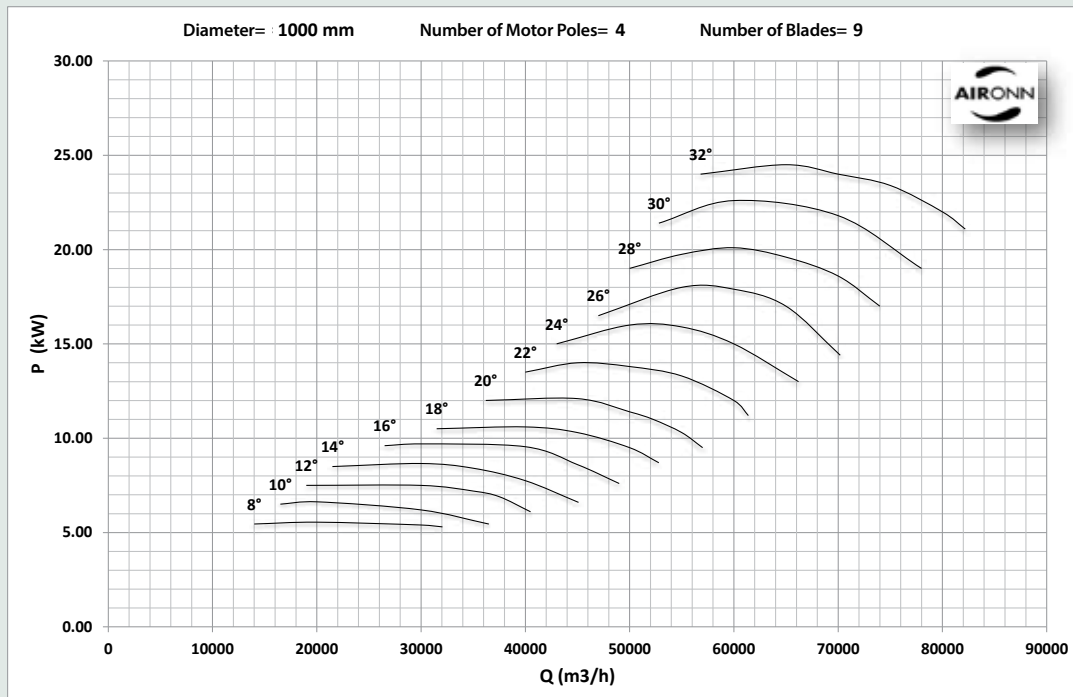
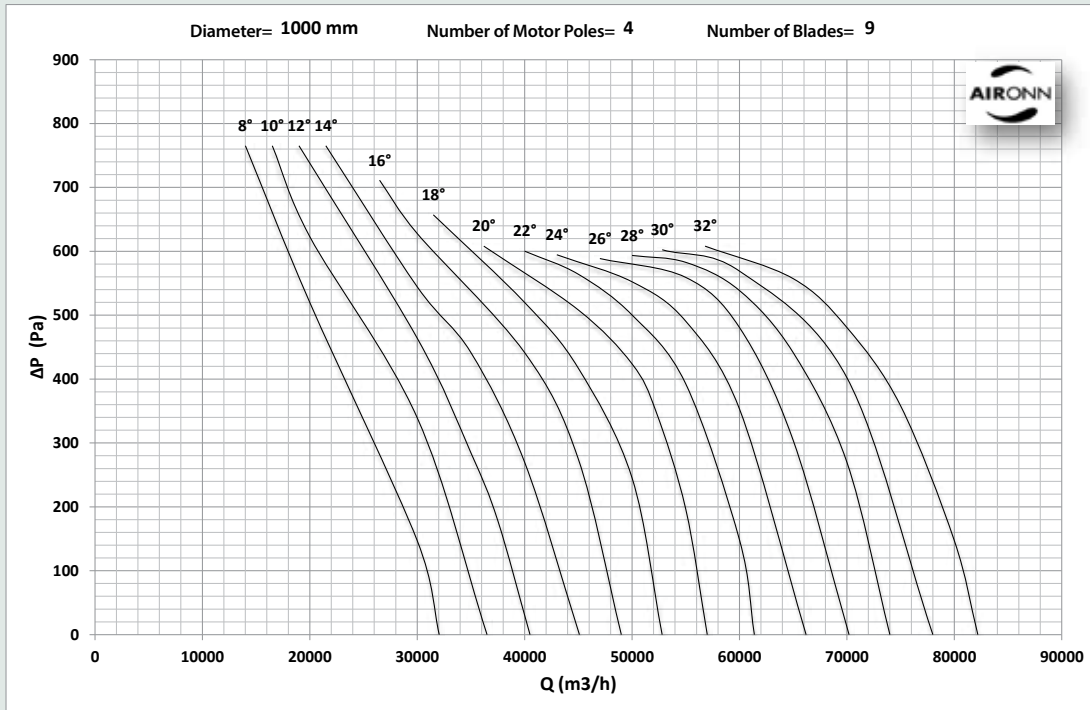

# Axial Hollow Smoke Exhaust Fan Series

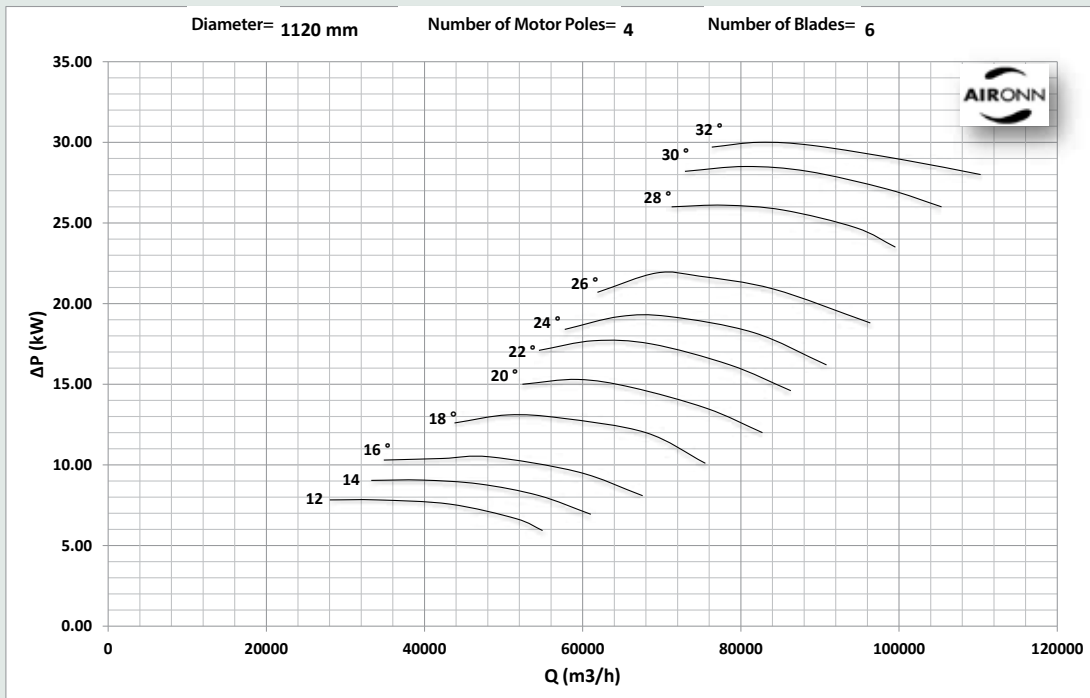
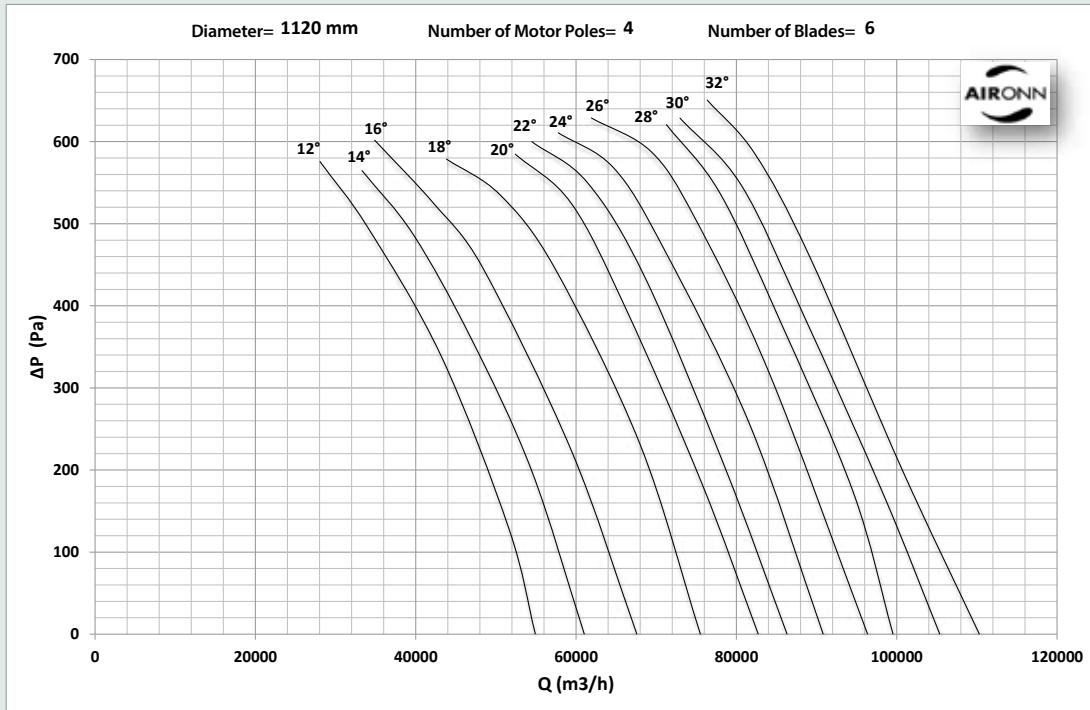

# Axial Hollow Smoke Exhaust Fan Series

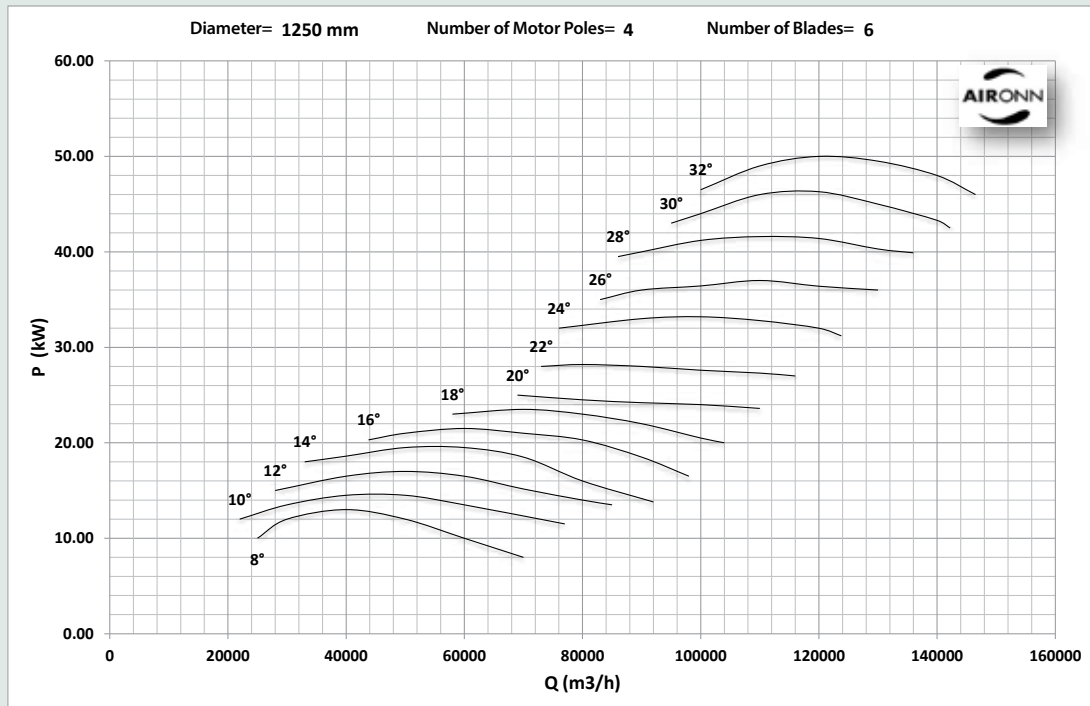
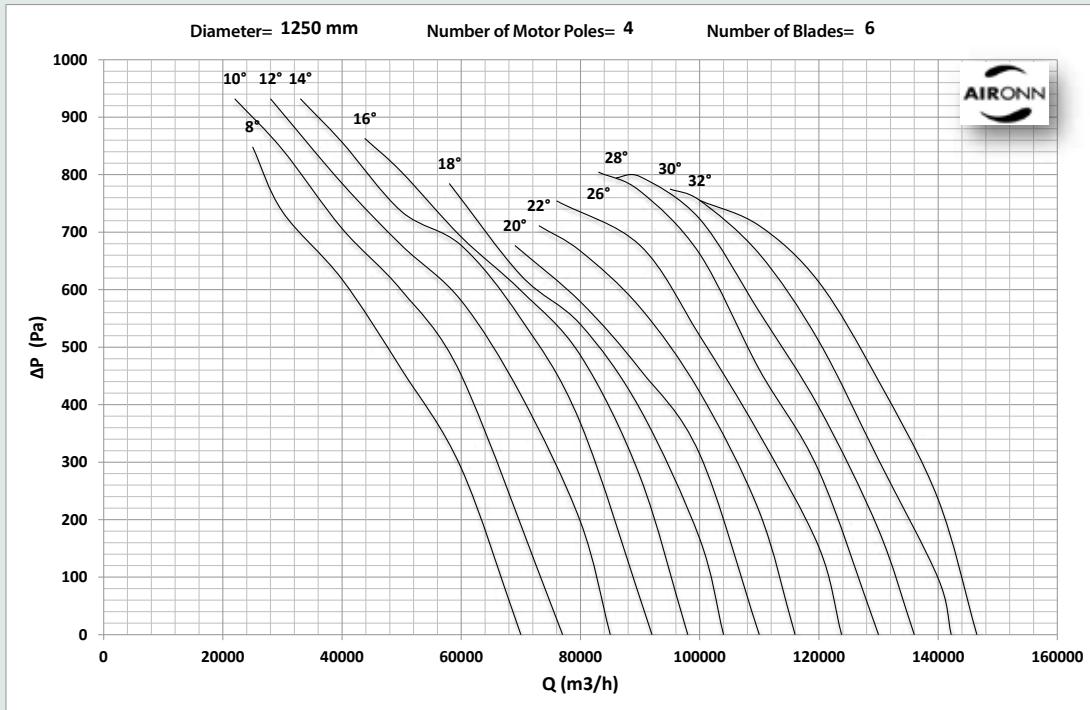

# Axial Hollow Smoke Exhaust Fan Series

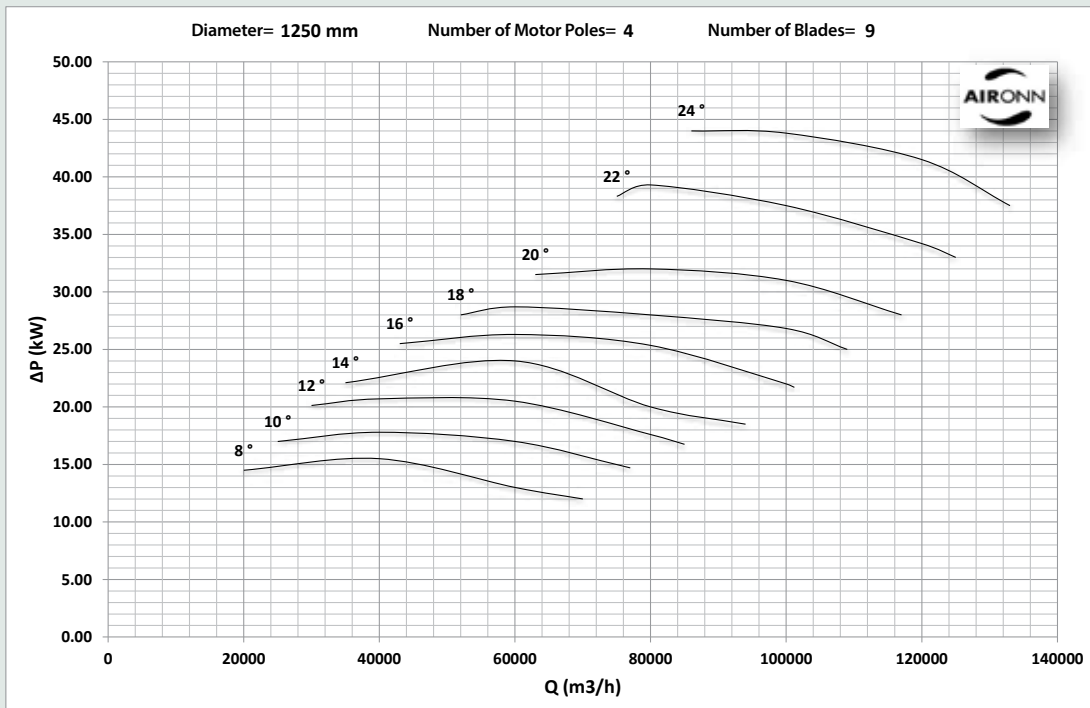
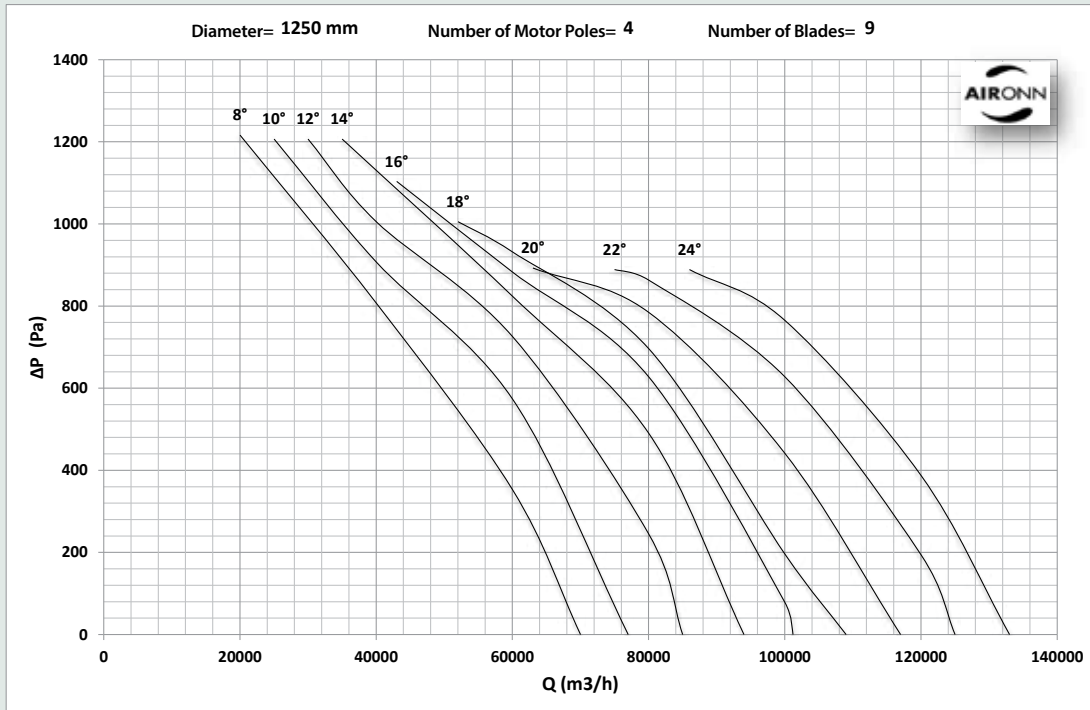

# Roof Type Axial (Horizontal) Smoke Exhaust Fan Series

Fans in the Aironn Roof Type Axial Smoke Exhaust Fan series have 300 °C-2 hours and 400 °C-2 hours certificates in compliance with EN 12101-3. Adjustable edge angle of the series in the range of diameters between 400 mm and 1250 mm presents a broad performance range. It also provides an advantage by precisely ensuring the required flow. Performance of the fans in Roof Type Axial Smoke Exhaust Fan Series have been tested in accordance with AMCA 210-07 standard.

## Fan Body

The body of the fans is made of high quality and corrosion resistant hot-dip galvanize coated sheet metal. The fan flanges are manufactured by bending the body so they are self flanged. All models have horizontal and vertical air throw options. Body inspection hatch is optional.

## Fan Blades

Aerodynamic fan blades are made of ETIAL 171 with injection moulding method. They are statically and dynamically balanced in compliance with ISO 1940/1-2003.

## Motor

IP 55 motors with class H insulation are available in single cycle or double cycle options. If requested, single cycle motors can be used with inverters.

## Electricity

IP 55 electric terminal box made of aluminium is standard.

## Accessories

Back Draft Damper, Counter Flange, Protection Grill, Flexible Coupling, Pacco (Package) Switch, Vibration Sensor, Inverter



# Roof Type Axial (Horizontal) Fresh Air Fan Series

Fans in Aironn Roof Type Fresh Air Fan Series are suitable to operate at maximum 55 °C. Adjustable edge angle of the series in the range of diameters between 400 mm and 1250 mm presents a broad performance range. It also provides an advantage by precisely ensuring the required flow. Performance of the fans in Roof Type Axial Fresh Air Fan series have been tested in accordance with AMCA 210-07 standard.

## Fan Body

The body of the fans is made of high quality and corrosion resistant hot-dip galvanize coated sheet metal. The fan flanges are manufactured by bending the body so they are self flanged. All models have horizontal and vertical air throw options. Body inspection hatch is optional.

## Fan Blades

Aerodynamic fan blades are made of ETIAL 171 with injection moulding method. They are statically and dynamically balanced in compliance with ISO 1940/1-2003.

## Motor

IP 55 motors with class F insulation are available in single cycle or double cycle options. If requested, single cycle motors can be used with inverters.

## Electricity

IP 55 electric terminal box made of plastic is standard.

## Accessories

Back Draft Damper, Counter Flange, Protection Grill, Flexible Coupling, Pacco (Package) Switch, Vibration Sensor, Inverter



# Roof Type Axial (Horizontal) Smoke Exhaust & Fresh Air Fan Series

## Dimensions

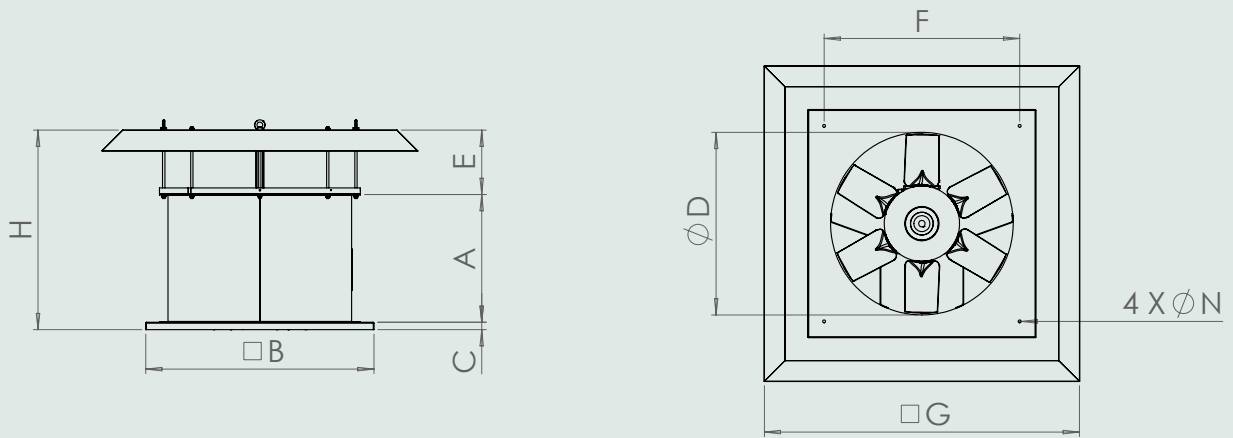

	A	B	C	D	E	F	G	H	ØN
400	420	575	30	400	155	525	900	660	11
450	420	630	30	450	151	580	963	660	11
500	420	695	30	500	147	645	1023	660	11
560	420	745	30	560	140	695	1095	660	11
630	470	815	30	630	151	765	1179	725	11
710	500	895	30	710	178	845	1275	790	11
800	580	995	30	800	191	945	1383	895	13
900	700	1090	30	900	241	1040	1400	1075	13
1000	775	1190	30	1000	265	1140	1624	1185	13
1250	775	1145	30	1250	240	1095	1720	1185	13



## Roof Type Axial (Horizontal) Fresh Air Fan Series

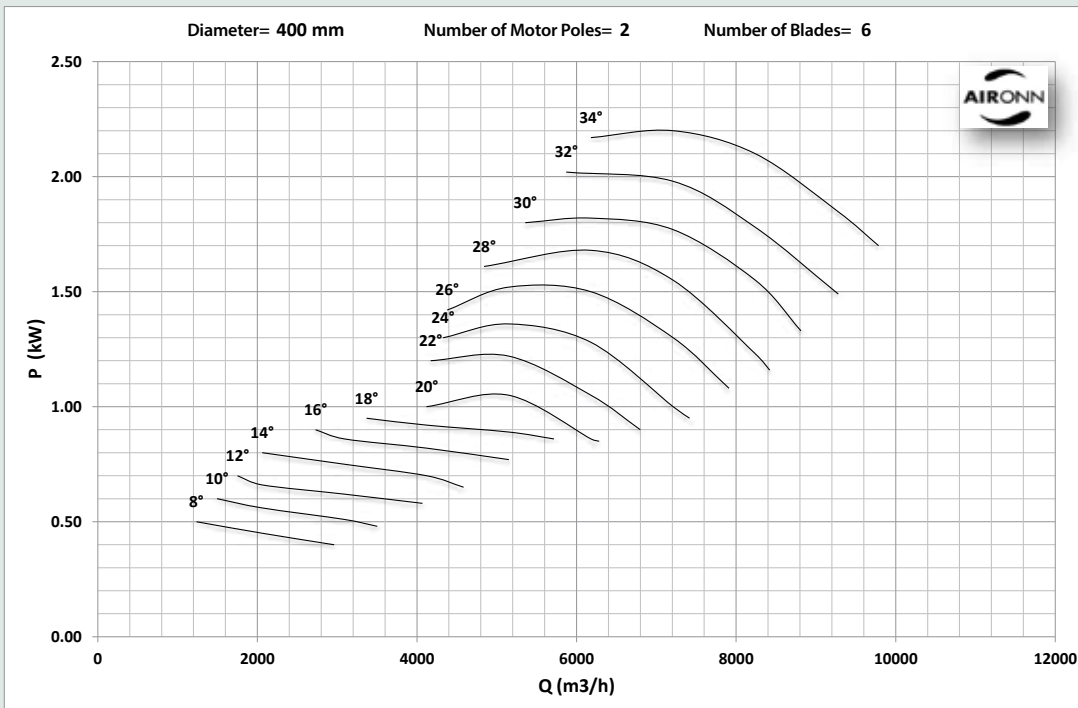
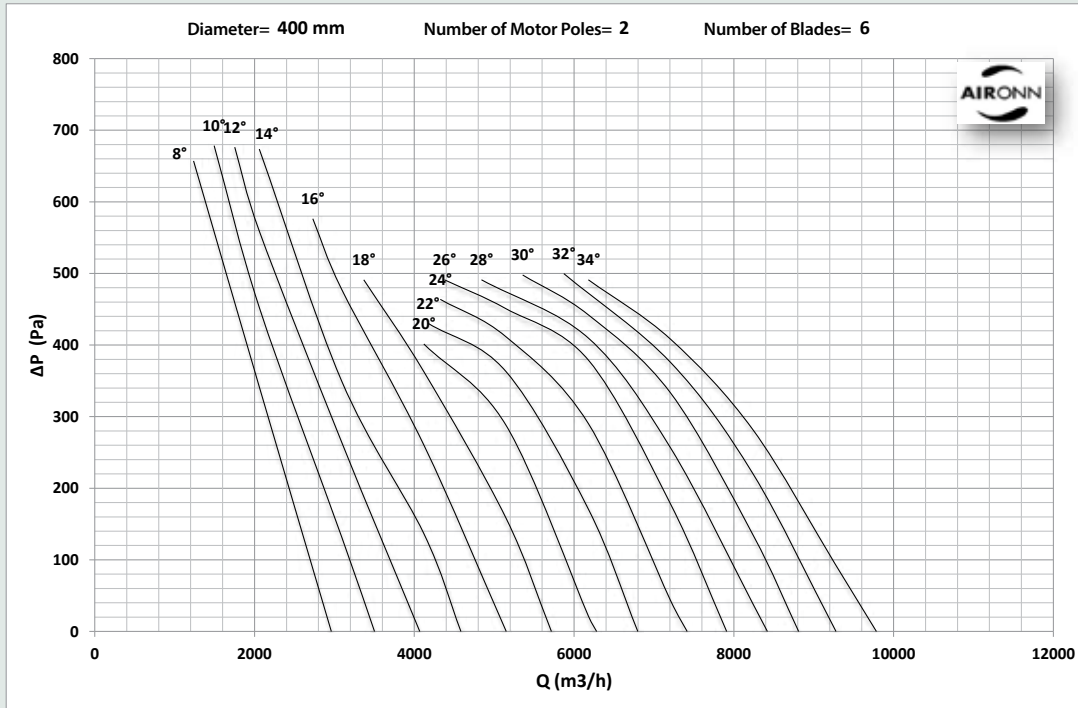

## Roof Type Axial (Horizontal) Fresh Air Fan Series

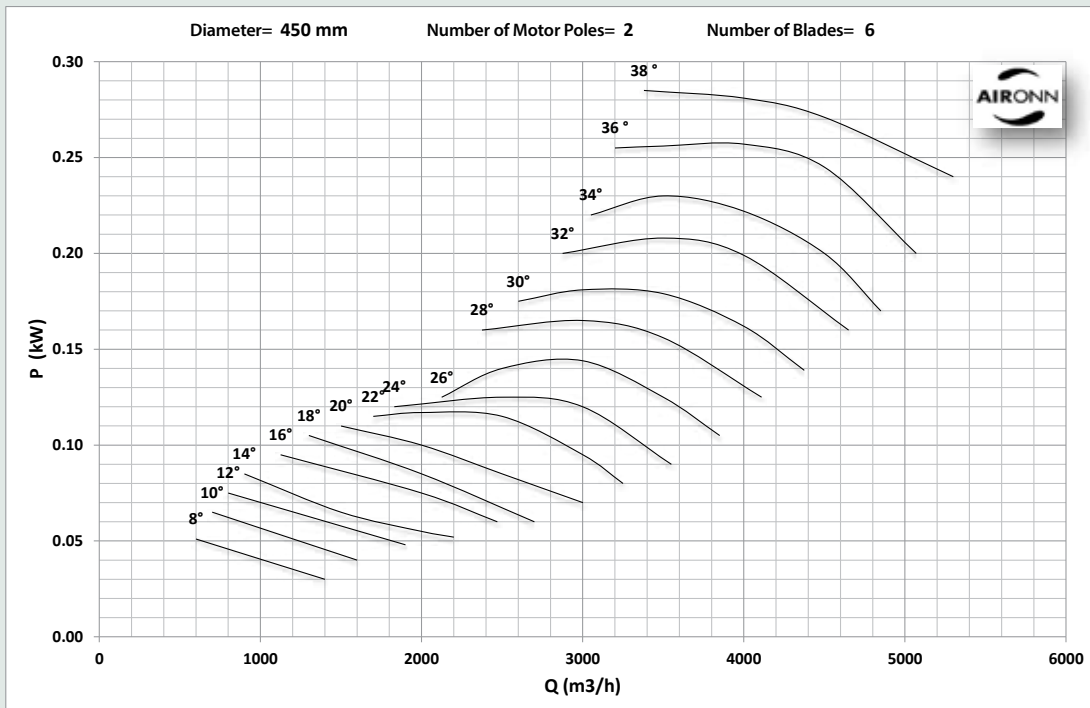
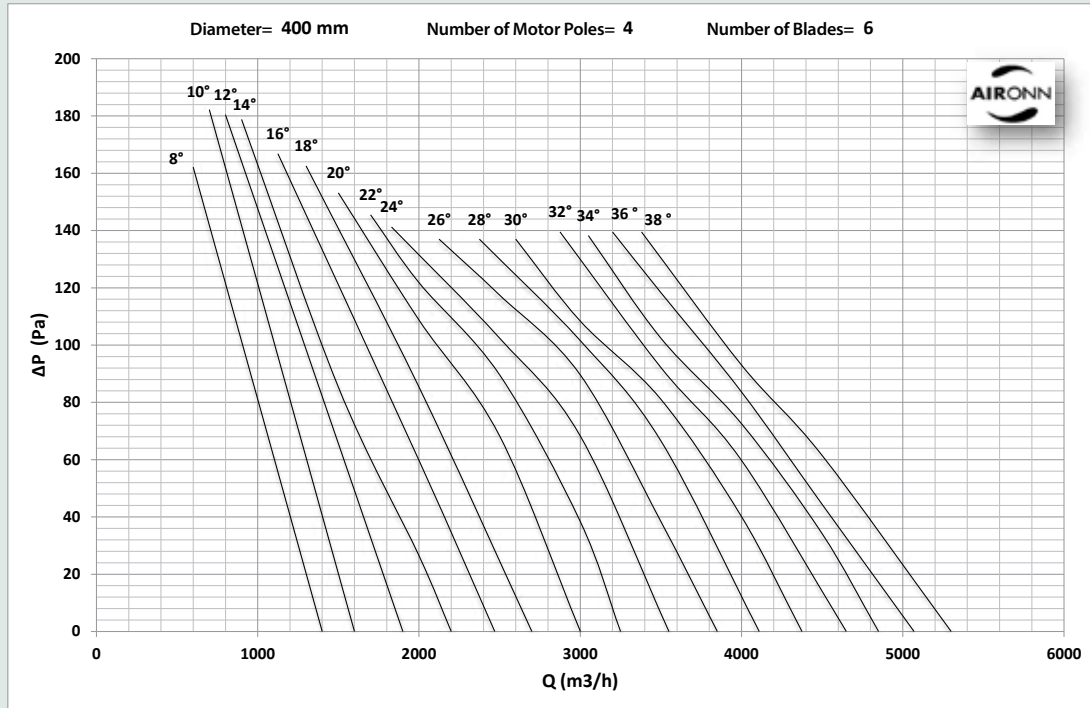

## Roof Type Axial (Horizontal) Fresh Air Fan Series

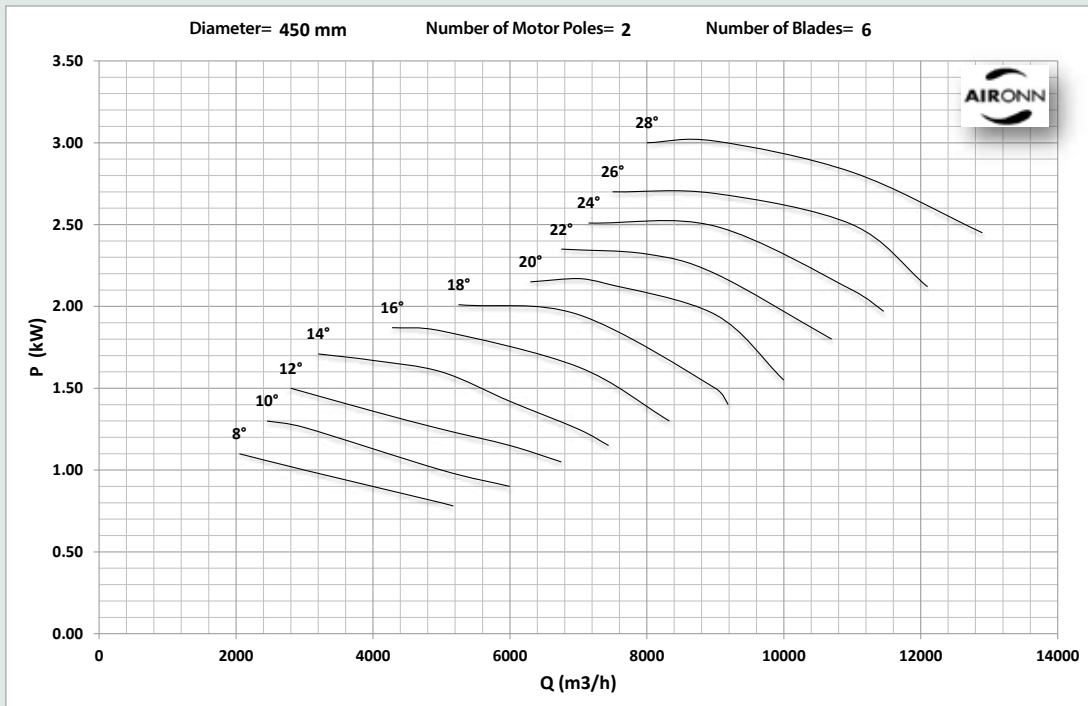
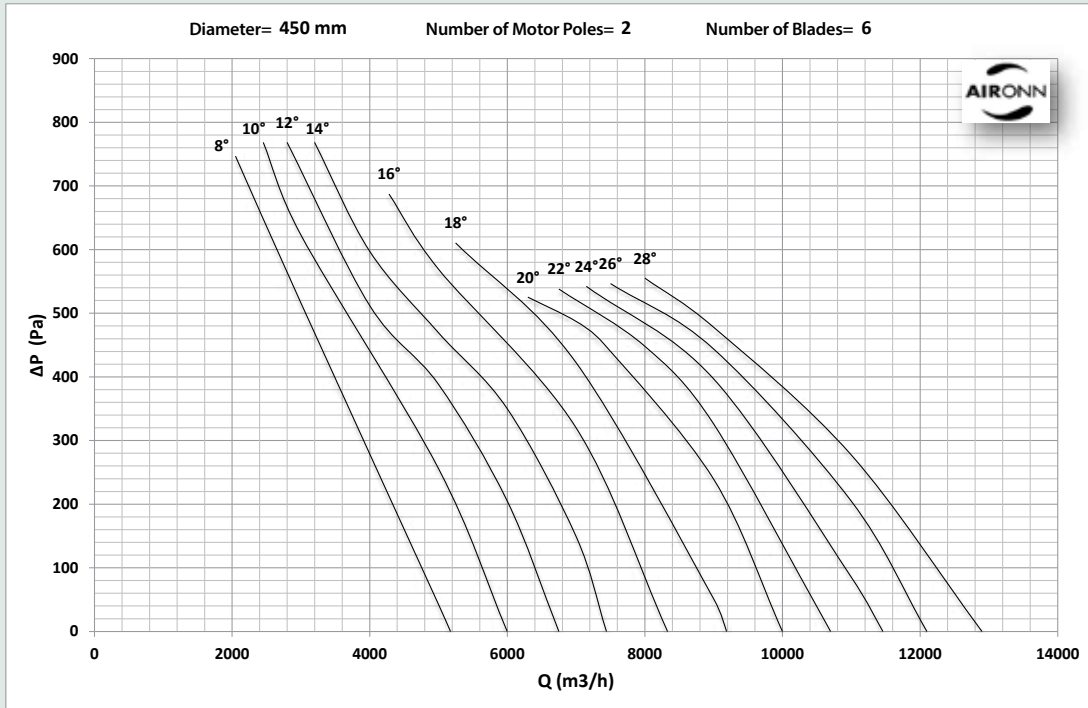

## Roof Type Axial (Horizontal) Fresh Air Fan Series

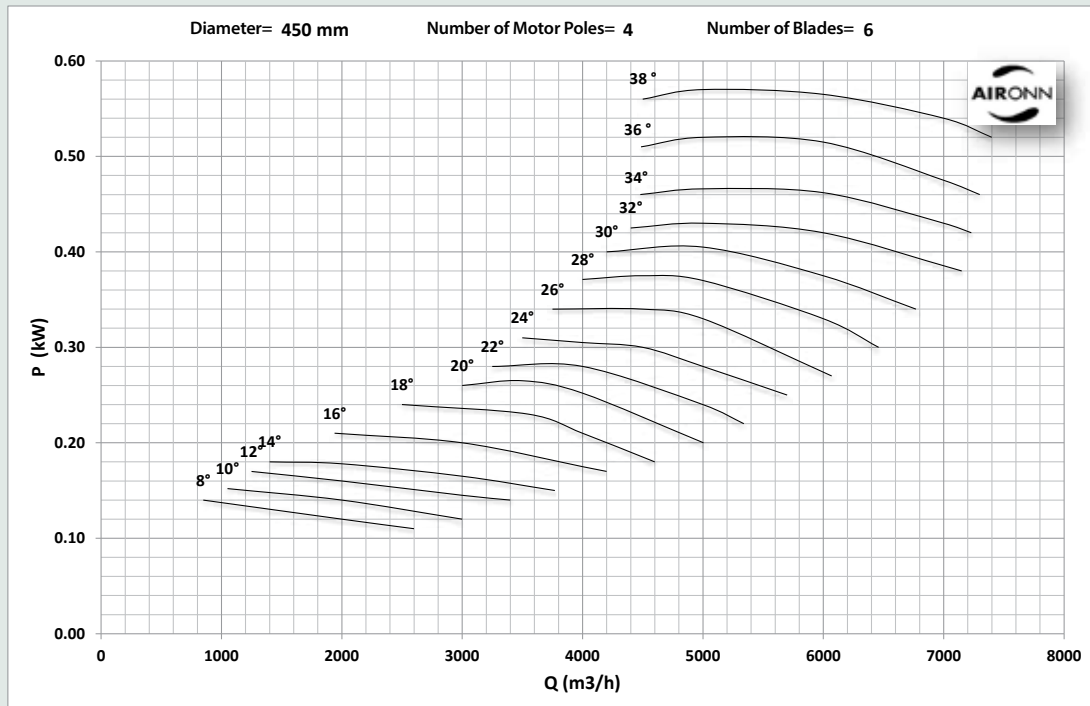
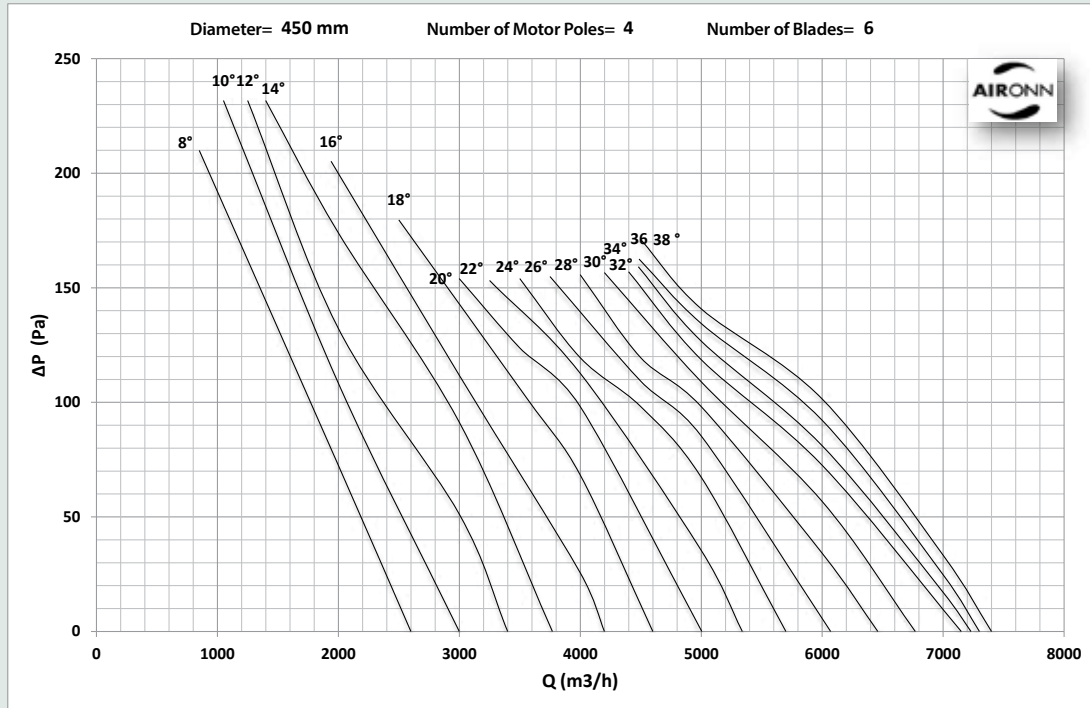

# Roof Type Axial (Horizontal) Fresh Air Fan Series

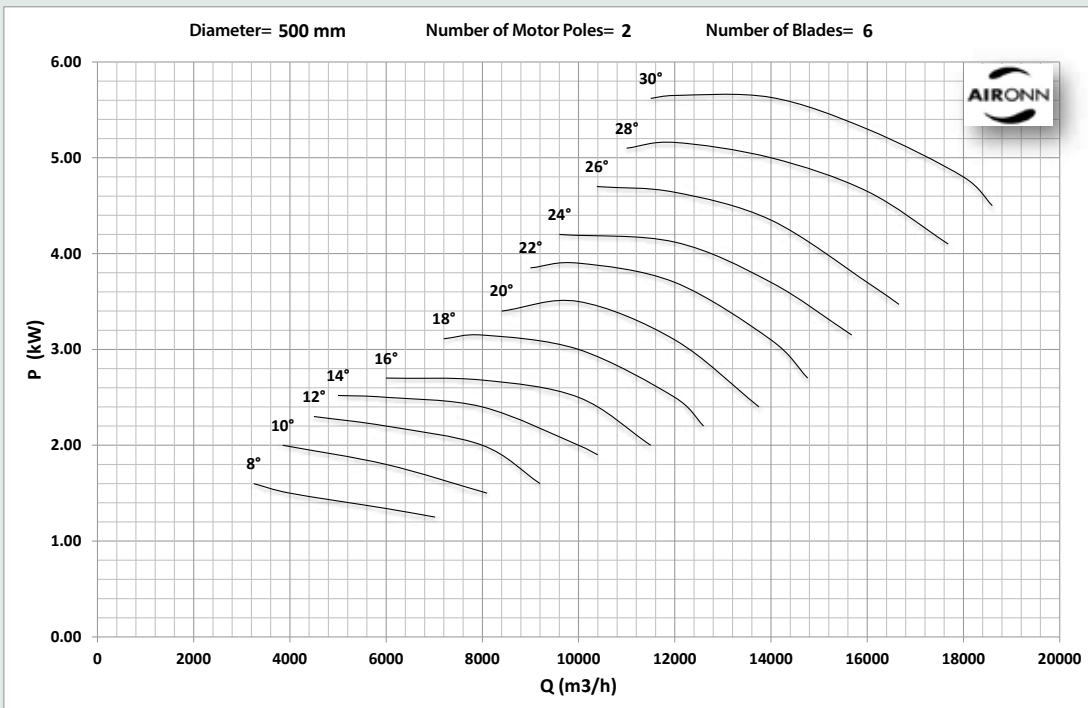
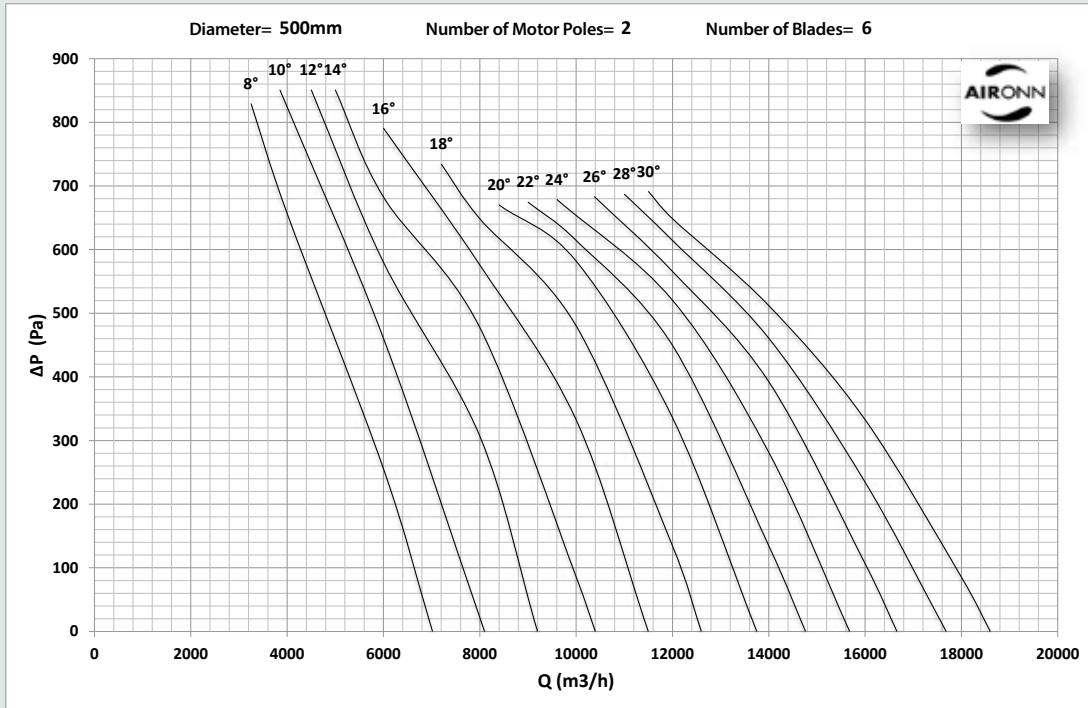

## Roof Type Axial (Horizontal) Fresh Air Fan Series

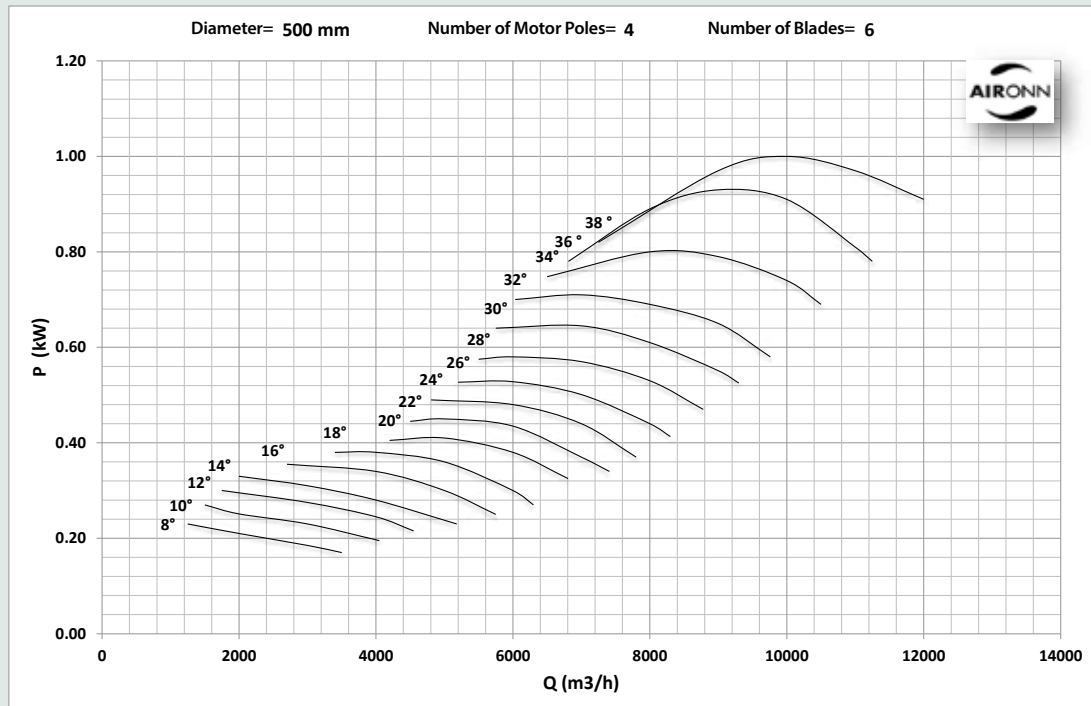
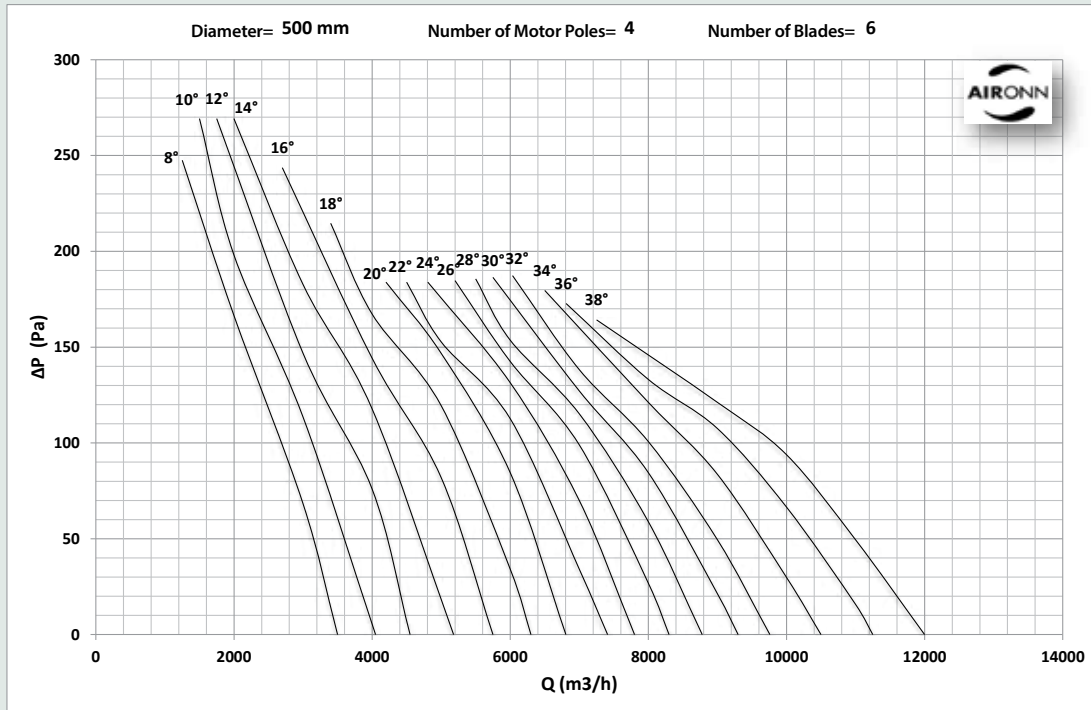

## Roof Type Axial (Horizontal) Fresh Air Fan Series

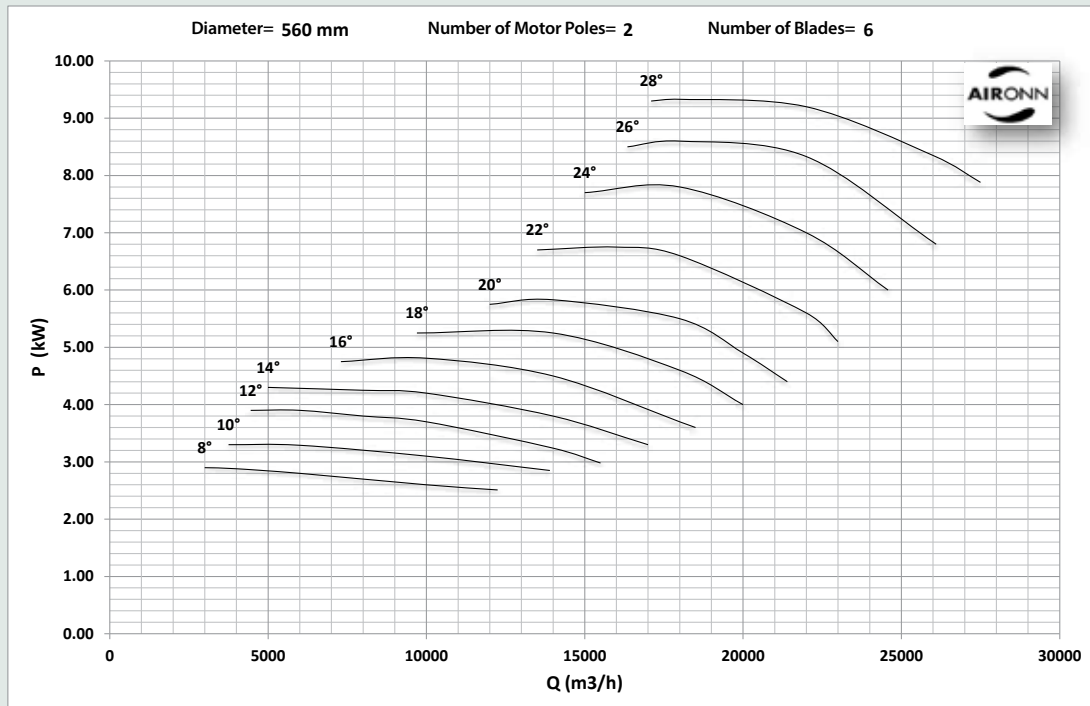
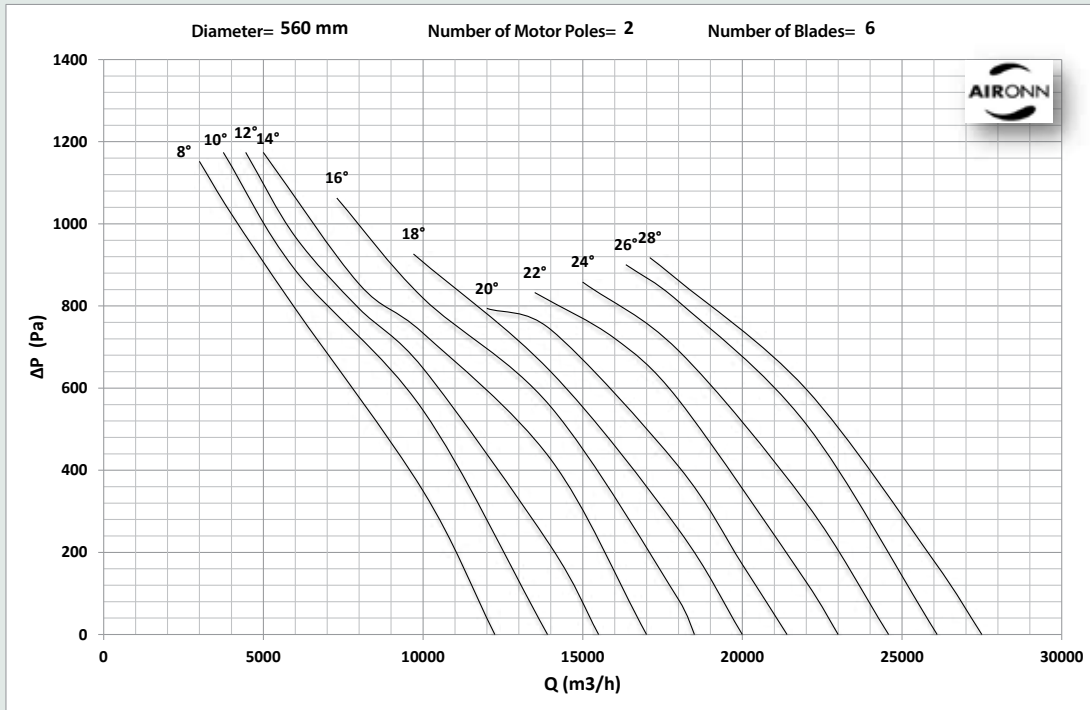

## Roof Type Axial (Horizontal) Fresh Air Fan Series

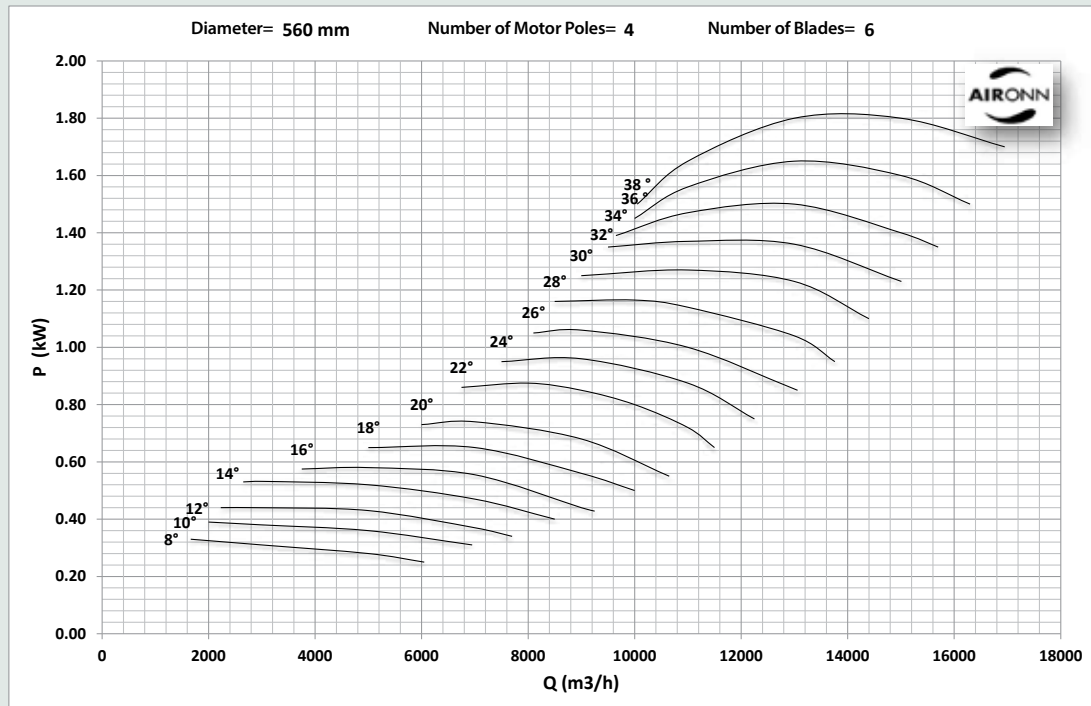
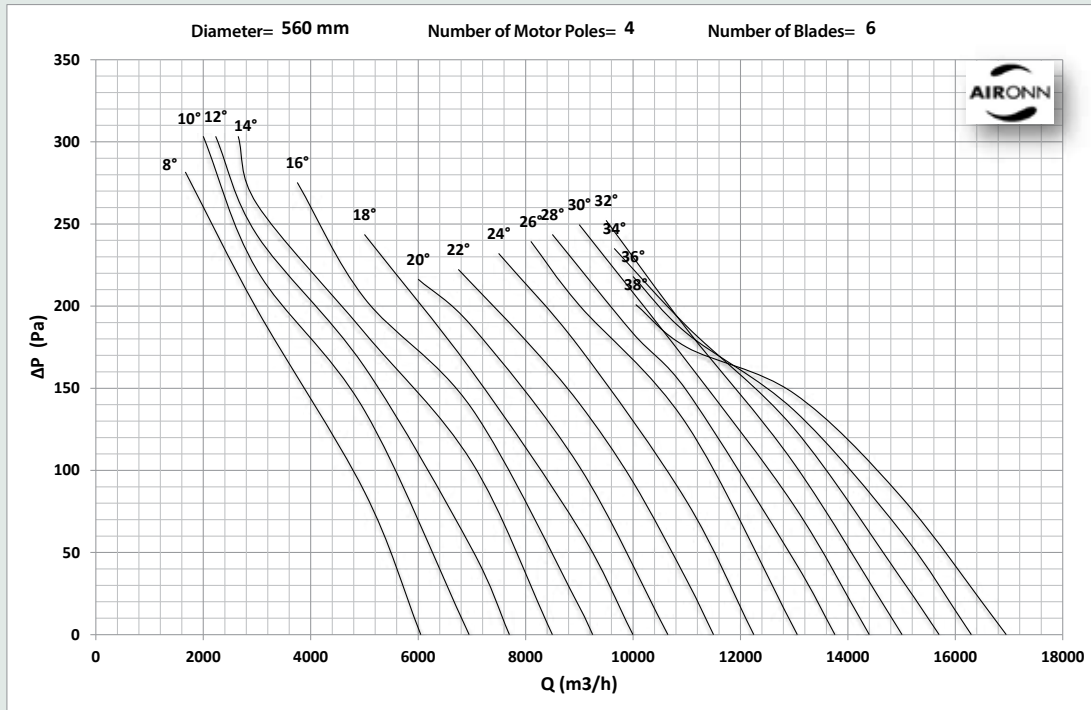



## Roof Type Axial (Horizontal) Fresh Air Fan Series

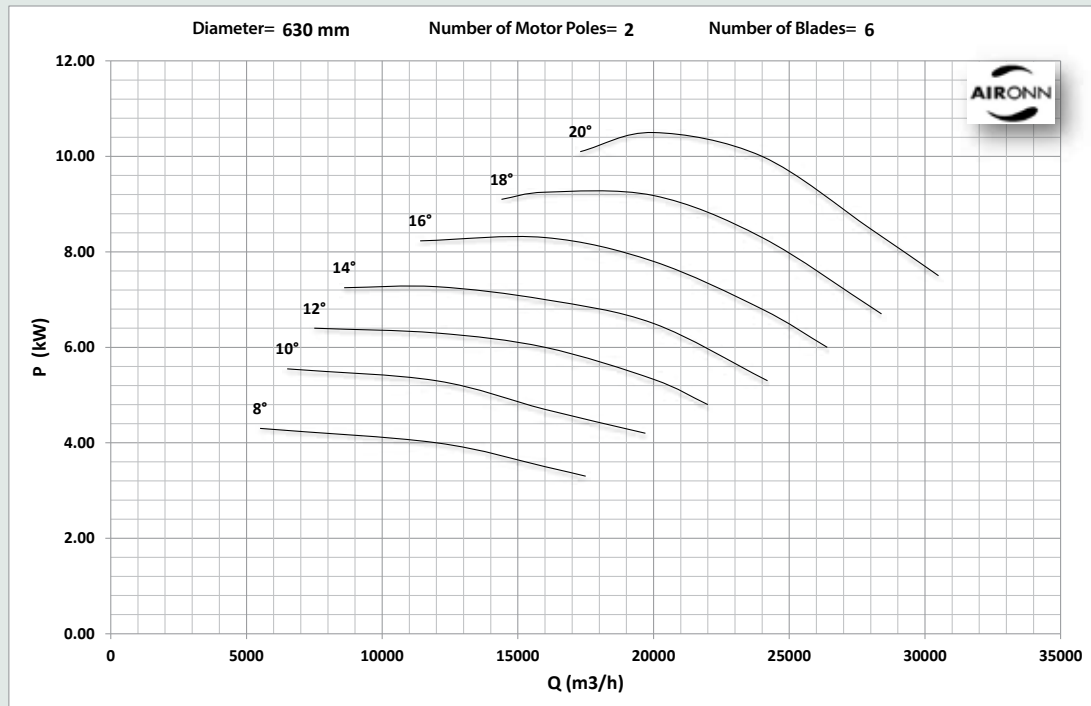
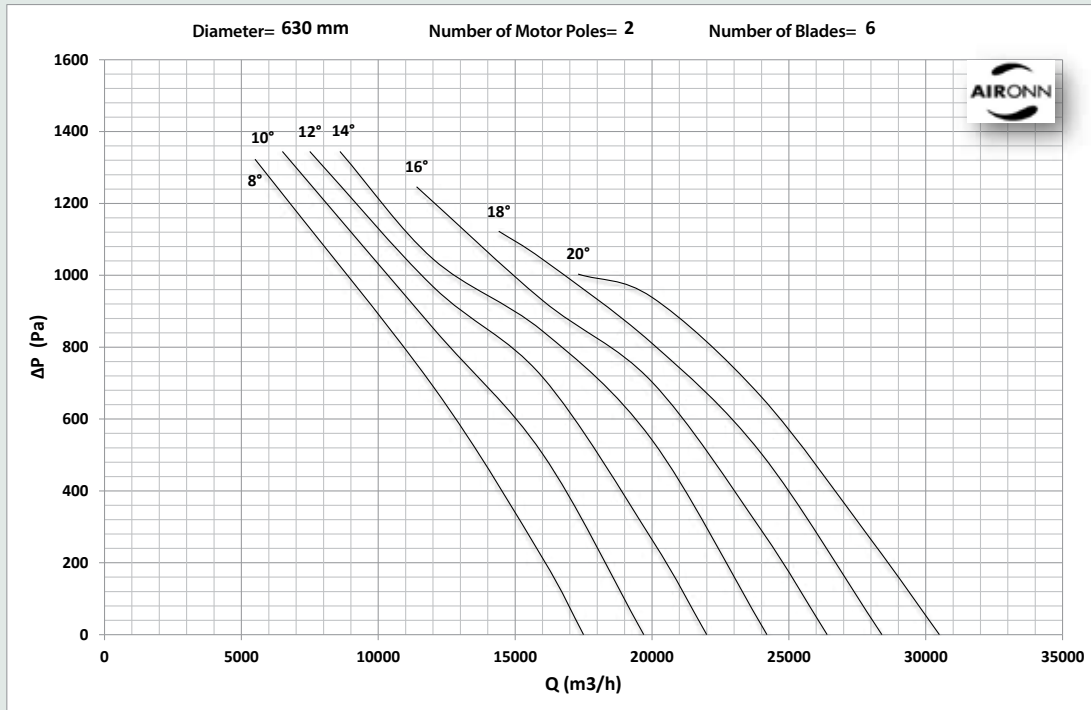

## Roof Type Axial (Horizontal) Fresh Air Fan Series

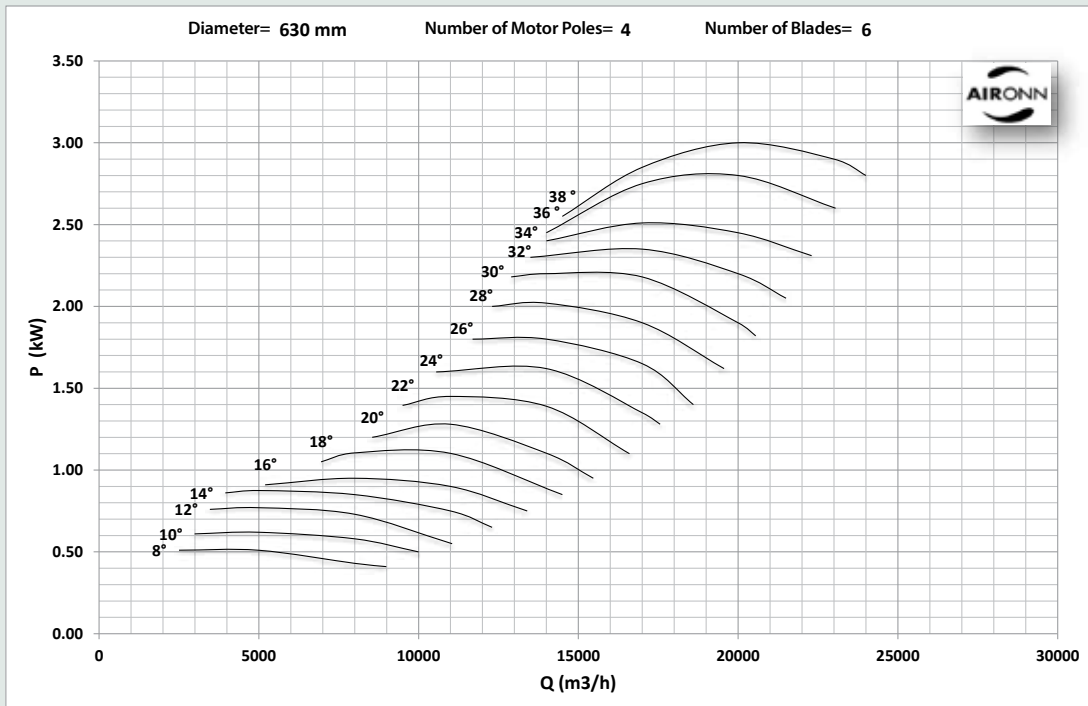
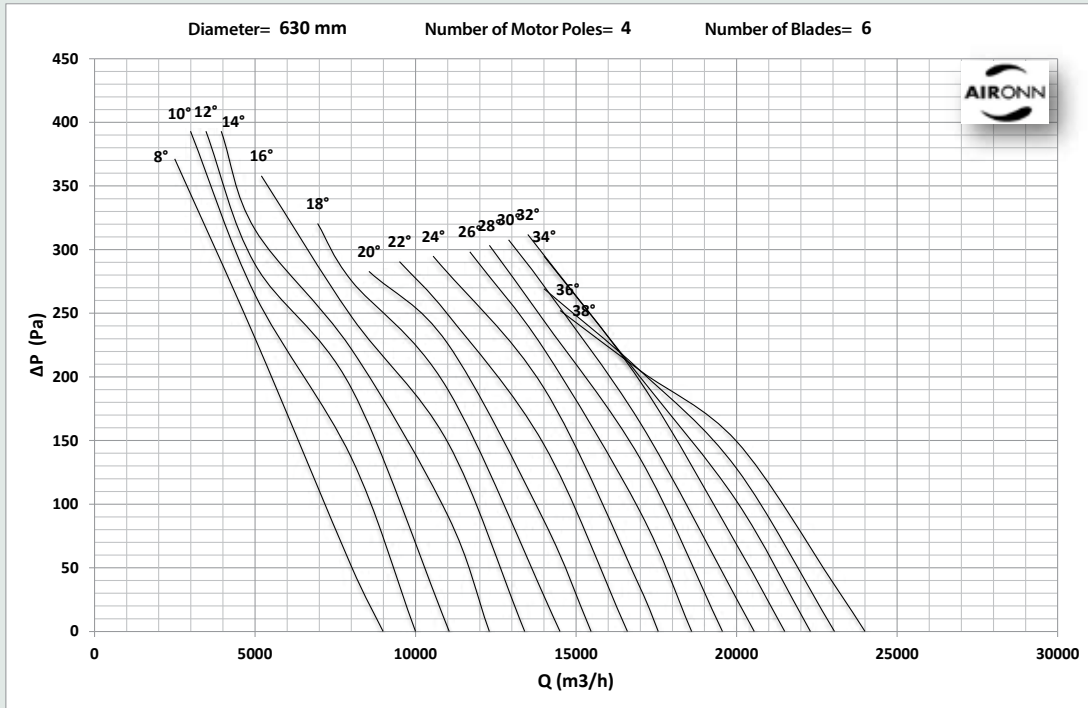

## Roof Type Axial (Horizontal) Fresh Air Fan Series

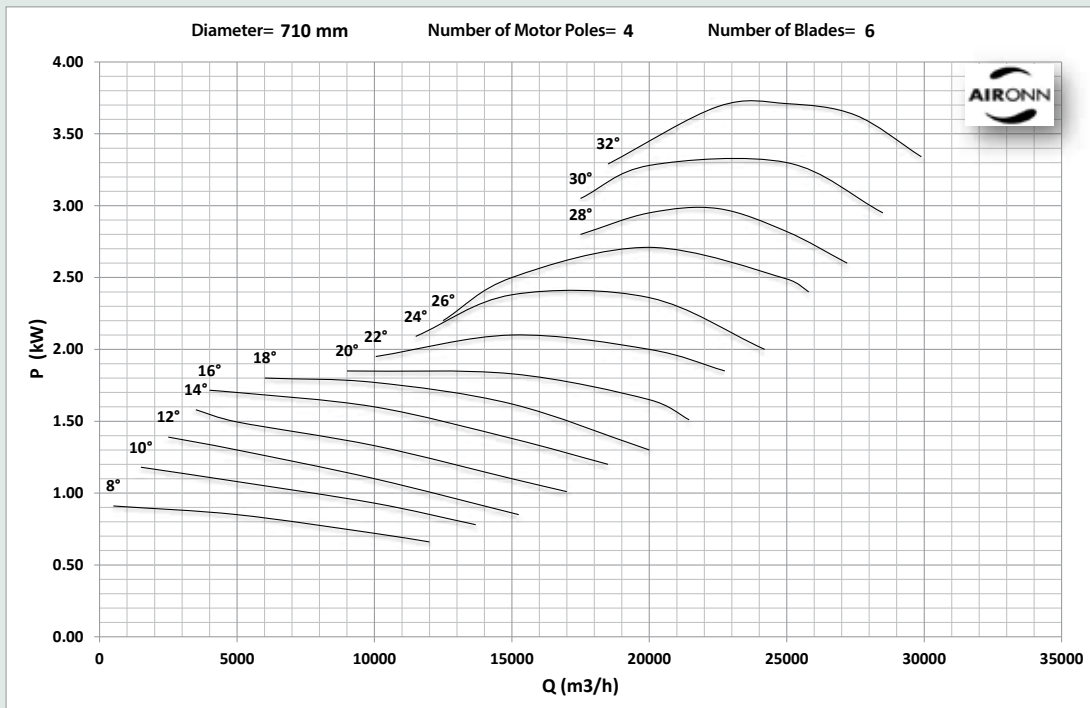
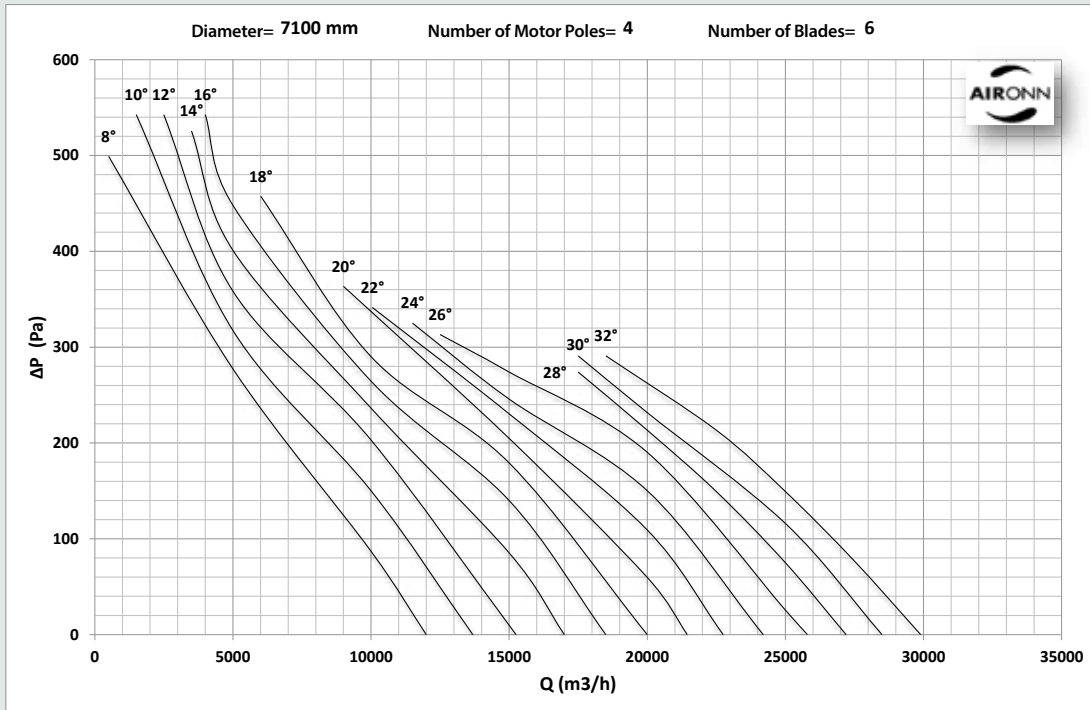

## Roof Type Axial (Horizontal) Fresh Air Fan Series

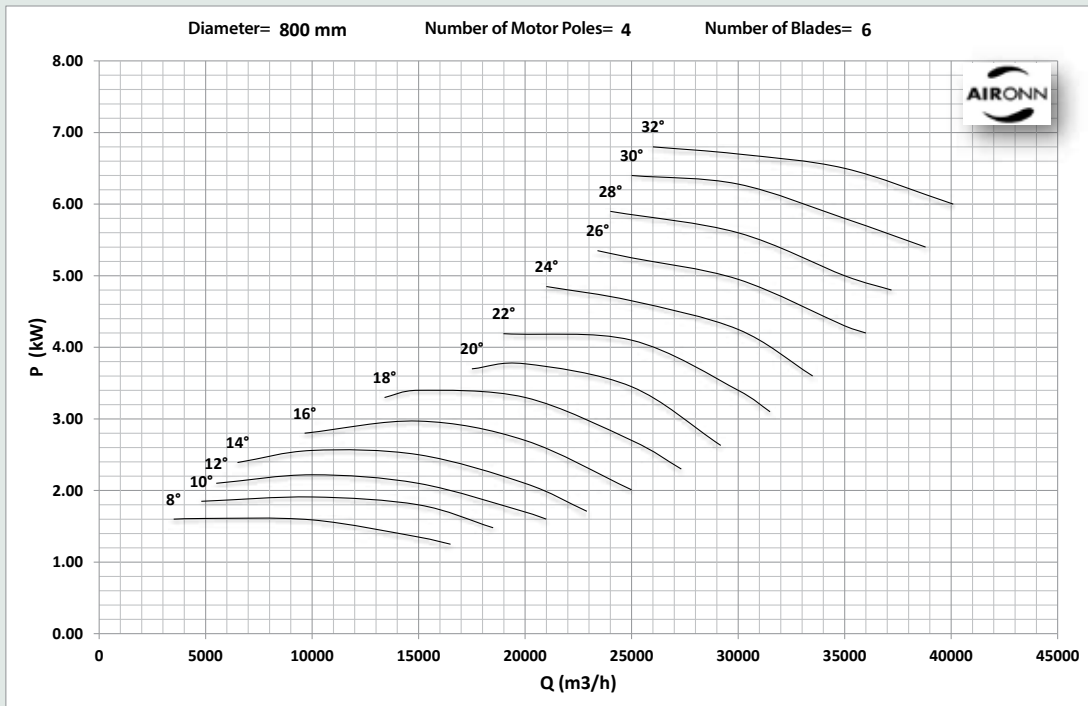
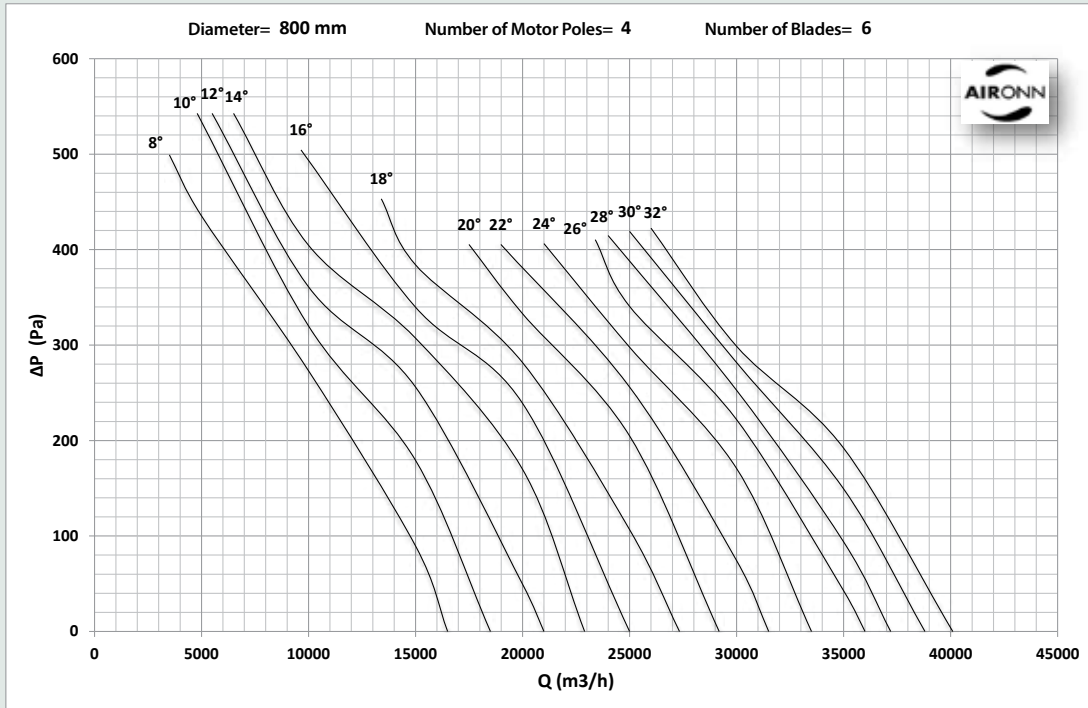

## Roof Type Axial (Horizontal) Fresh Air Fan Series

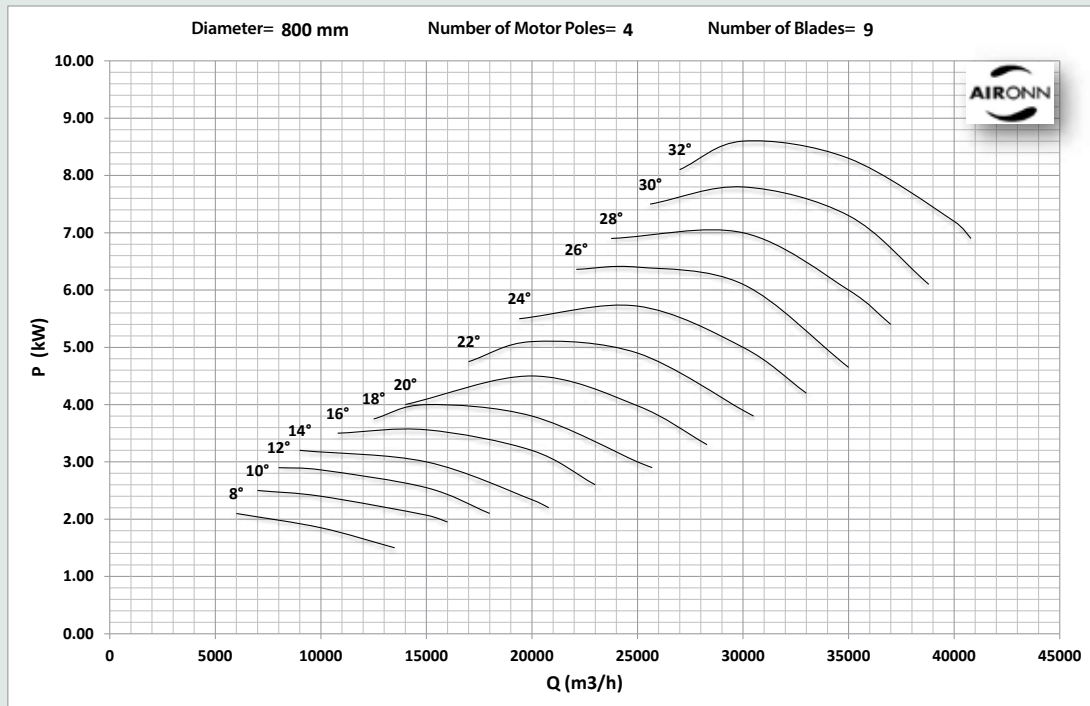
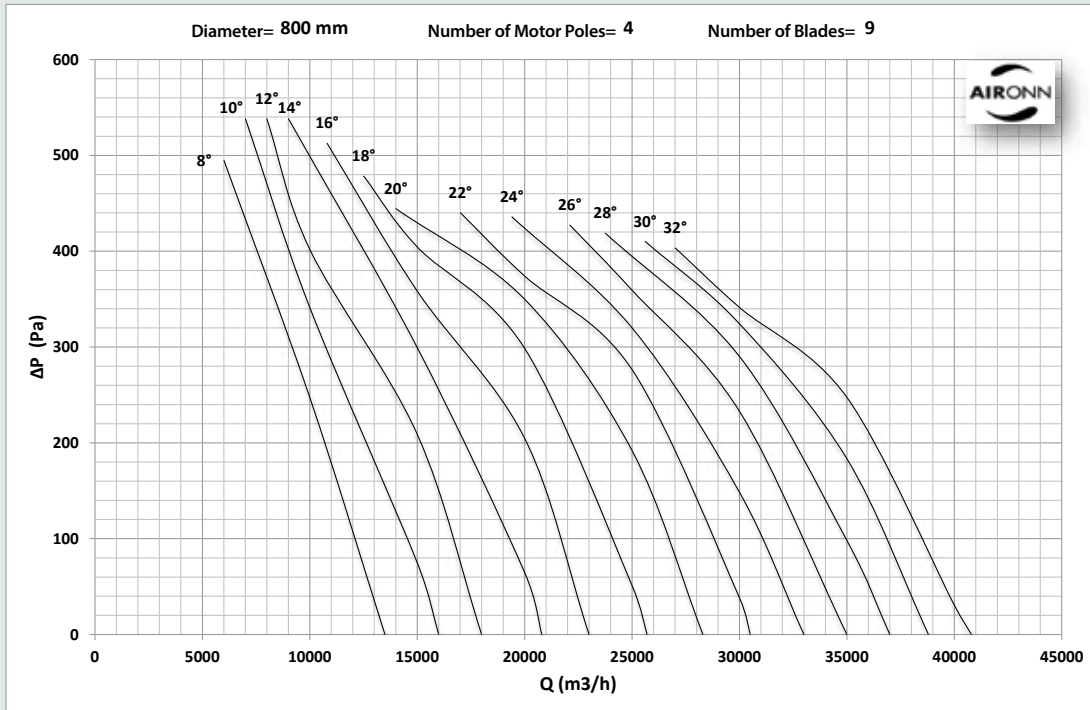

## Roof Type Axial (Horizontal) Fresh Air Fan Series

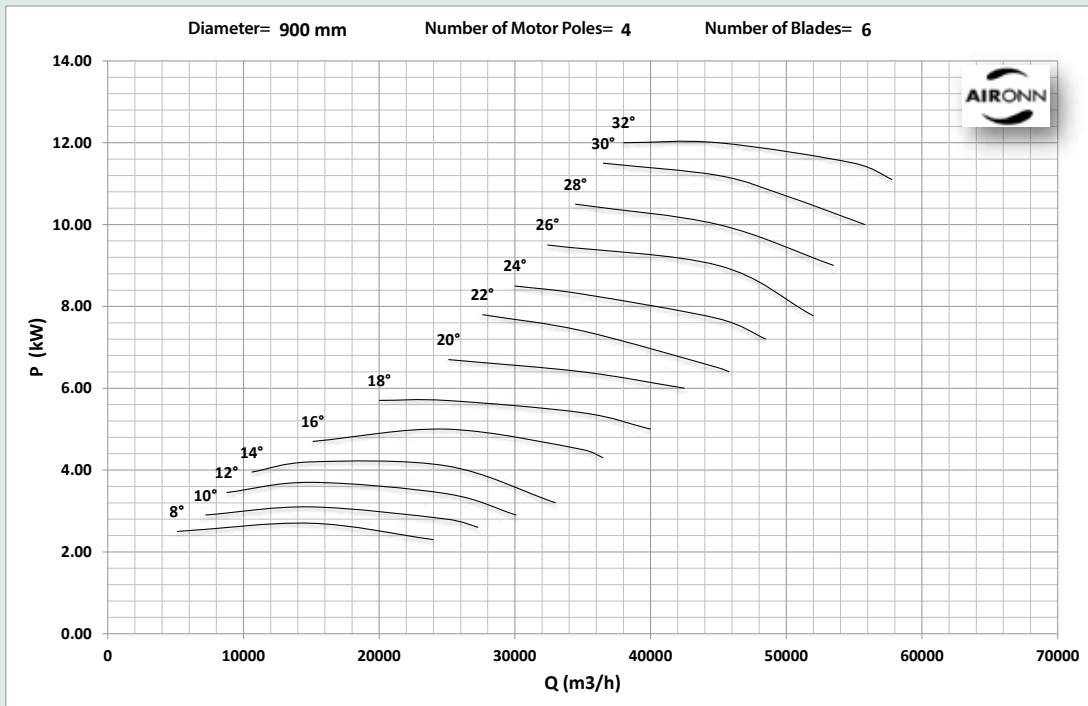
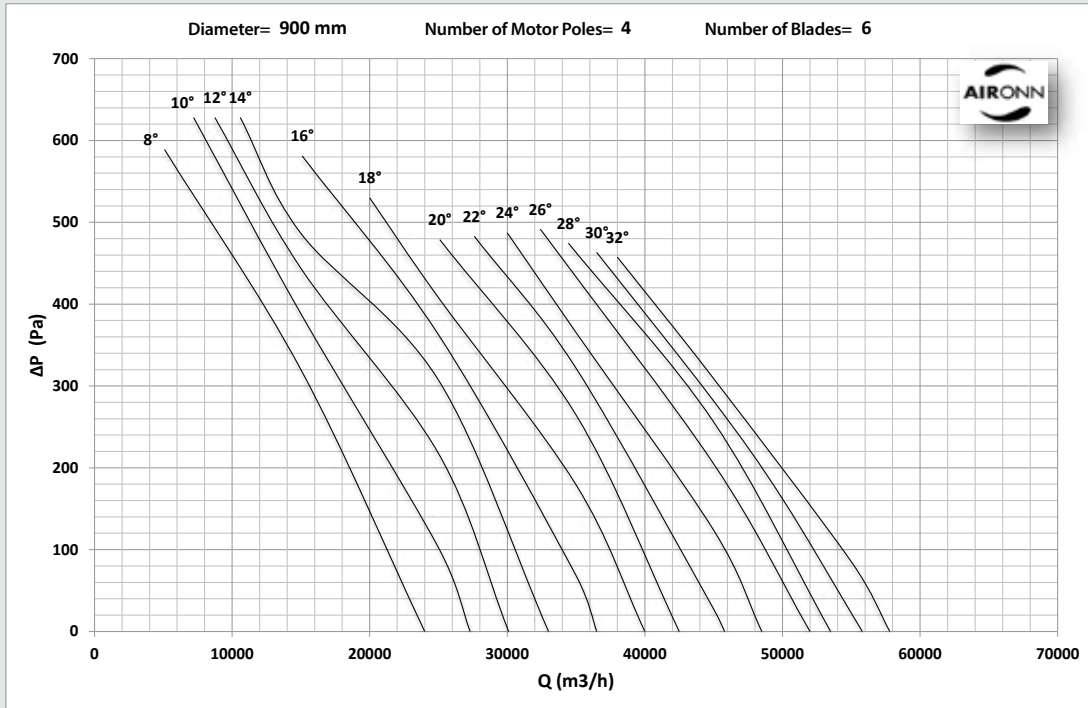

## Roof Type Axial (Horizontal) Fresh Air Fan Series

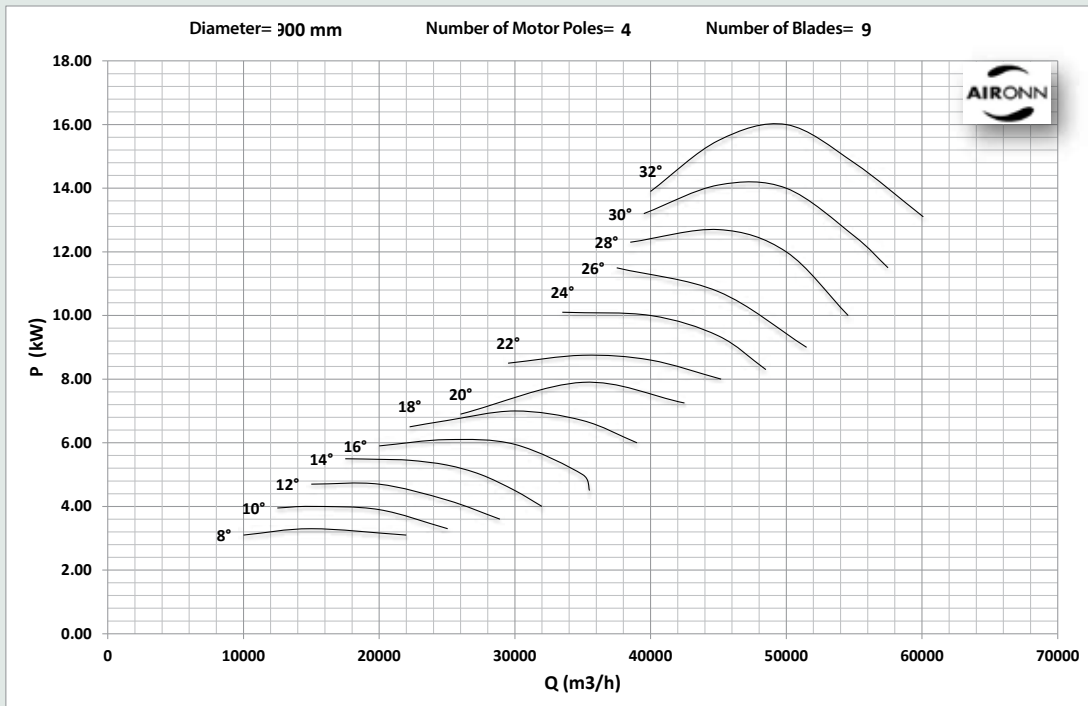
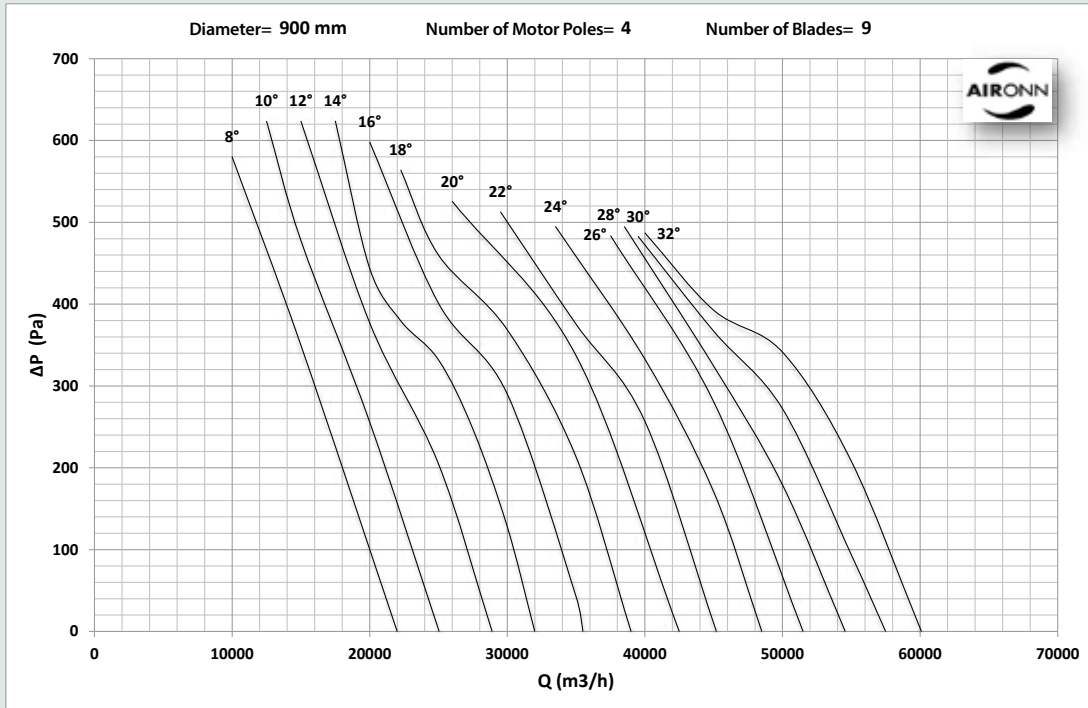

## Roof Type Axial (Horizontal) Fresh Air Fan Series

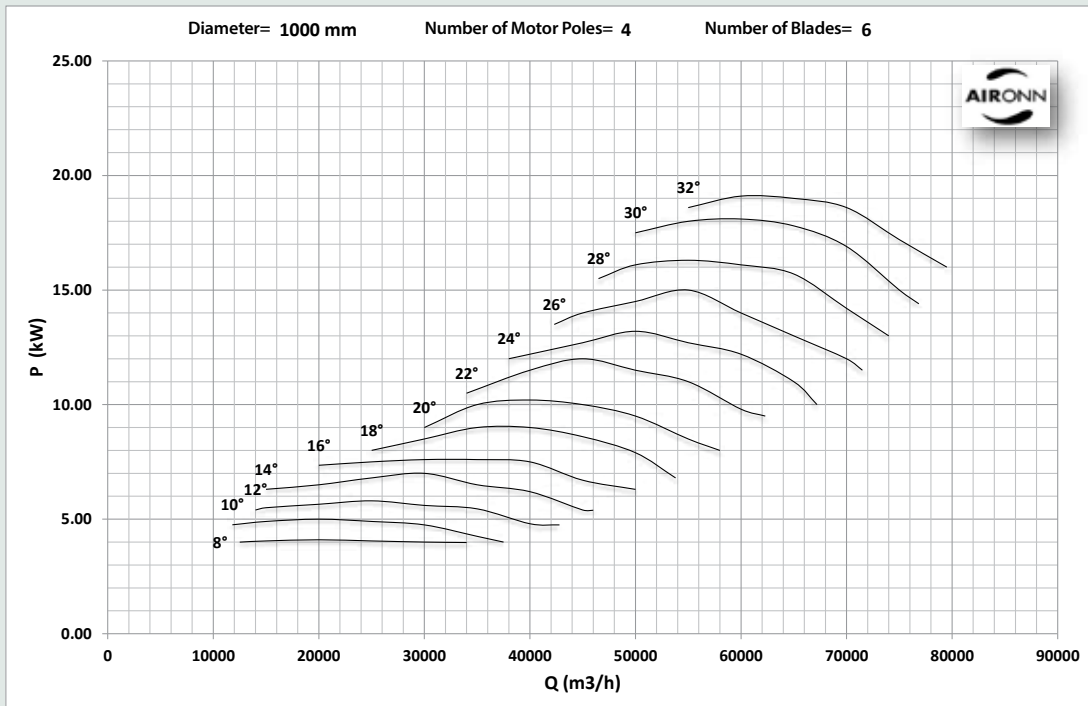
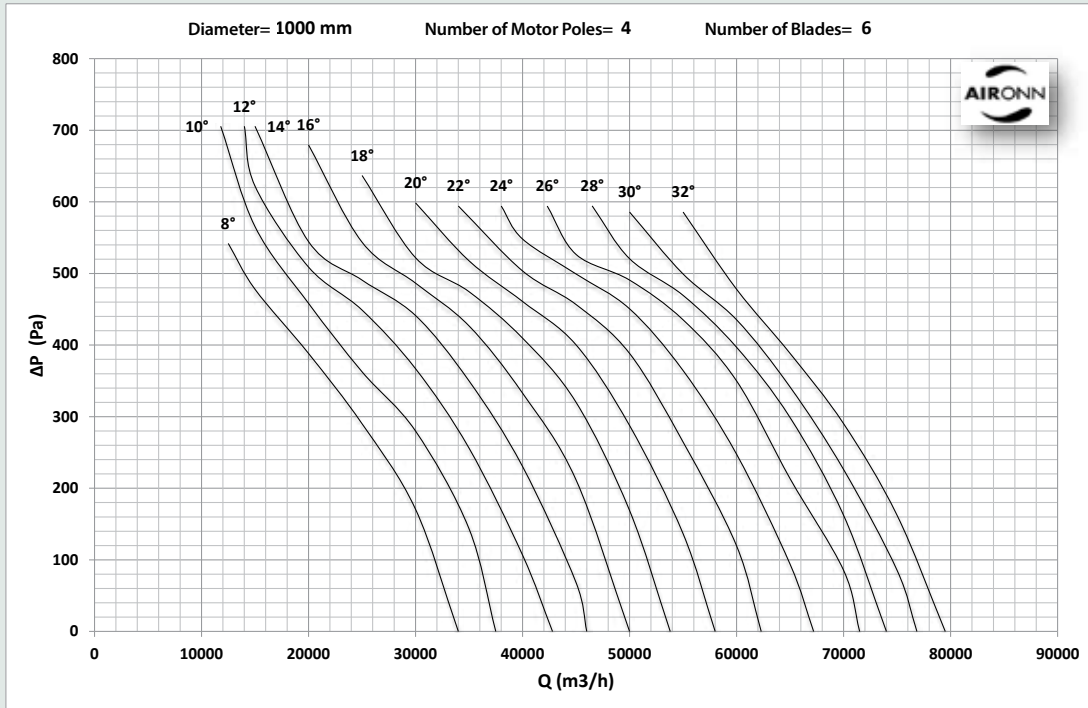



## Roof Type Axial (Horizontal) Fresh Air Fan Series

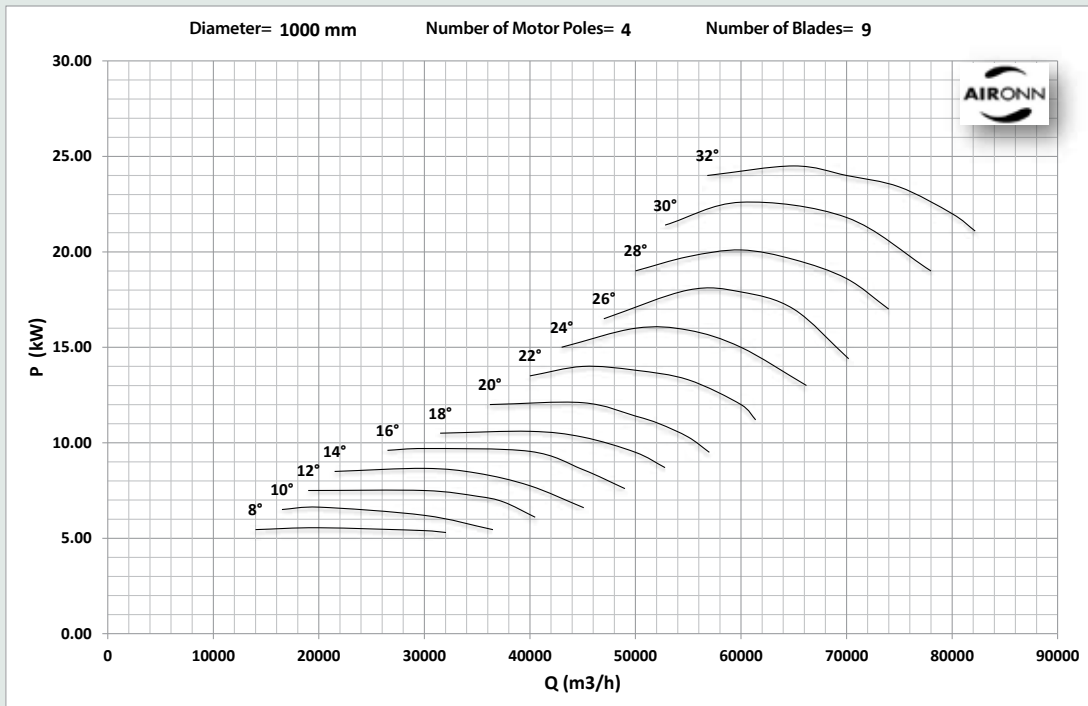
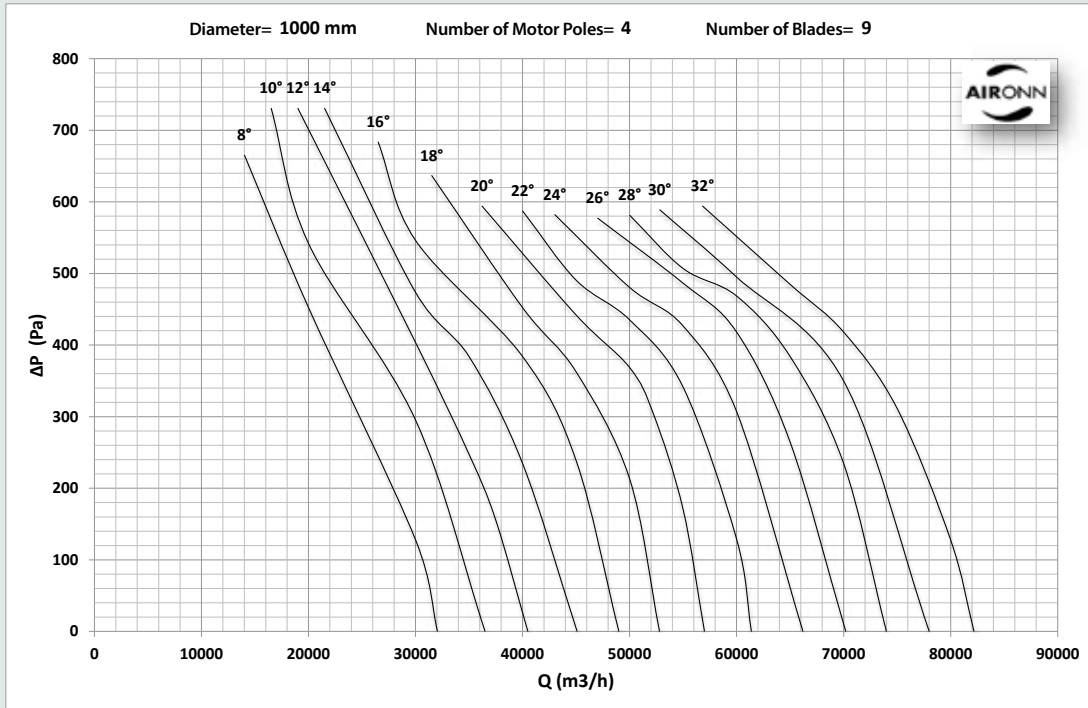

## Roof Type Axial (Horizontal) Fresh Air Fan Series

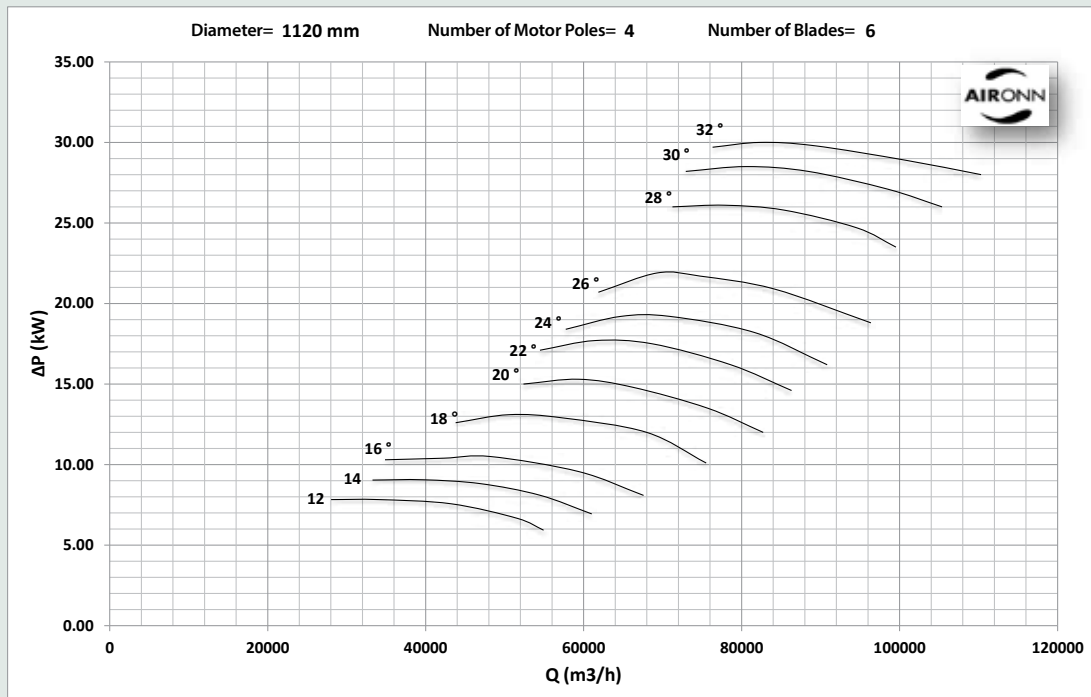
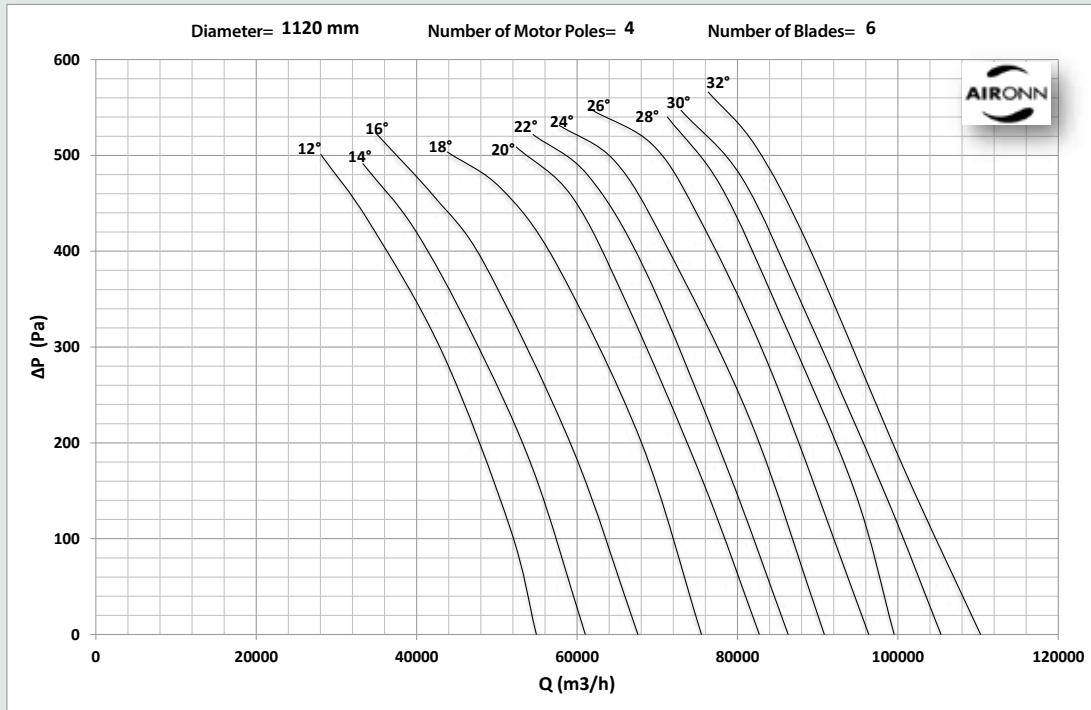

## Roof Type Axial (Horizontal) Fresh Air Fan Series

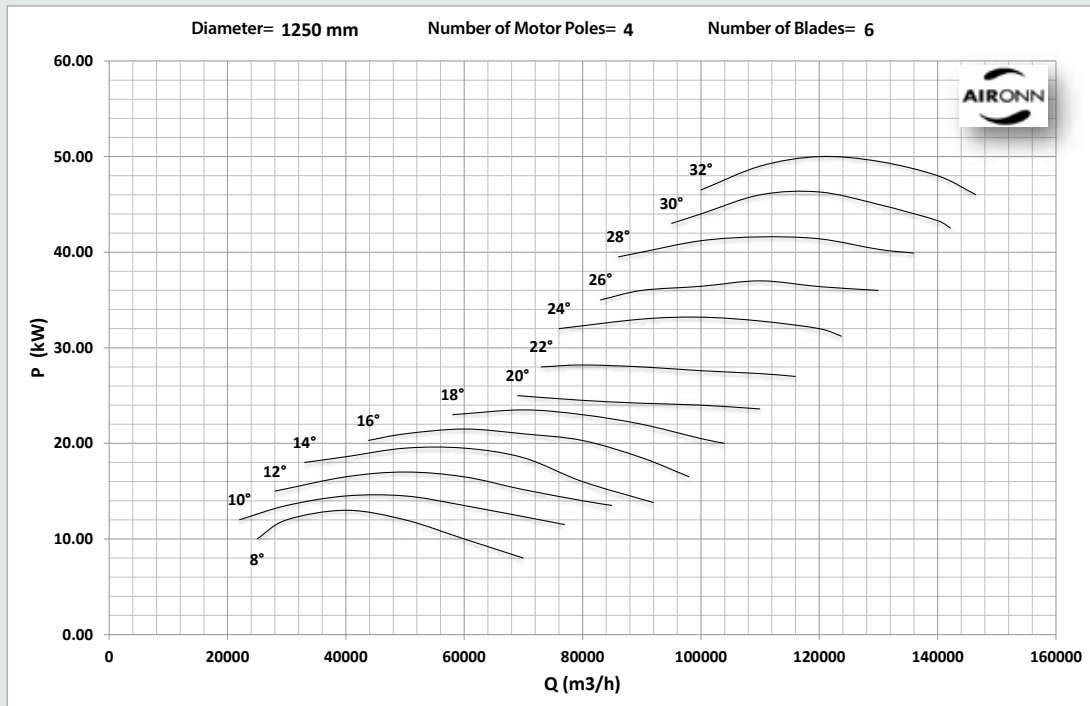
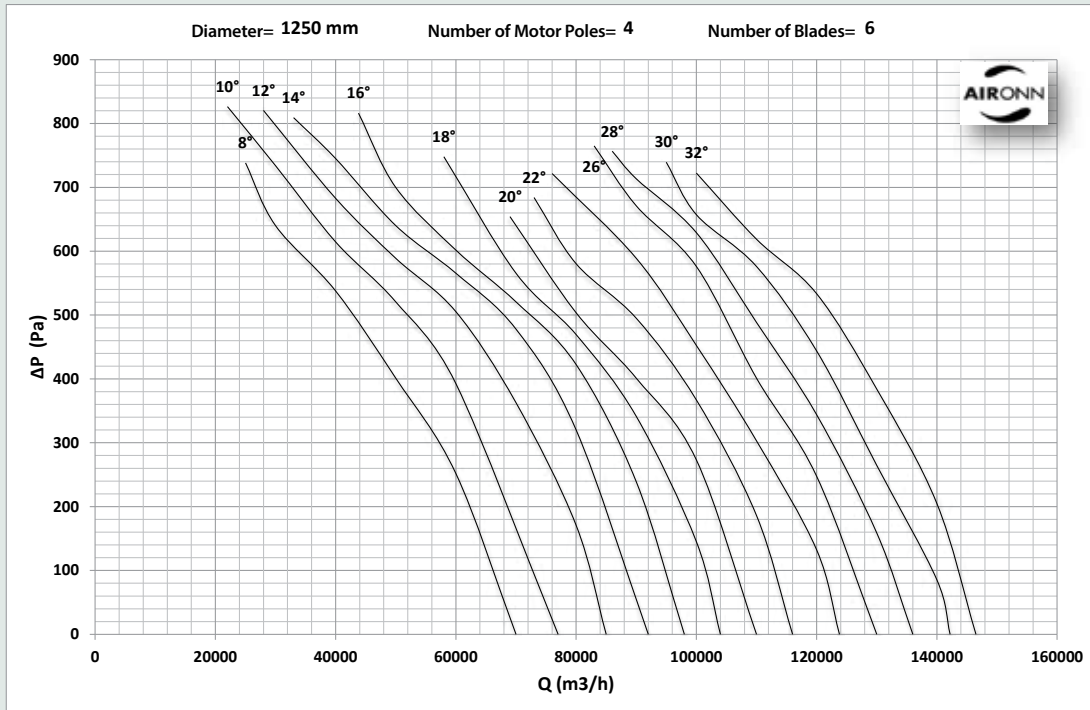

## Roof Type Axial (Horizontal) Fresh Air Fan Series

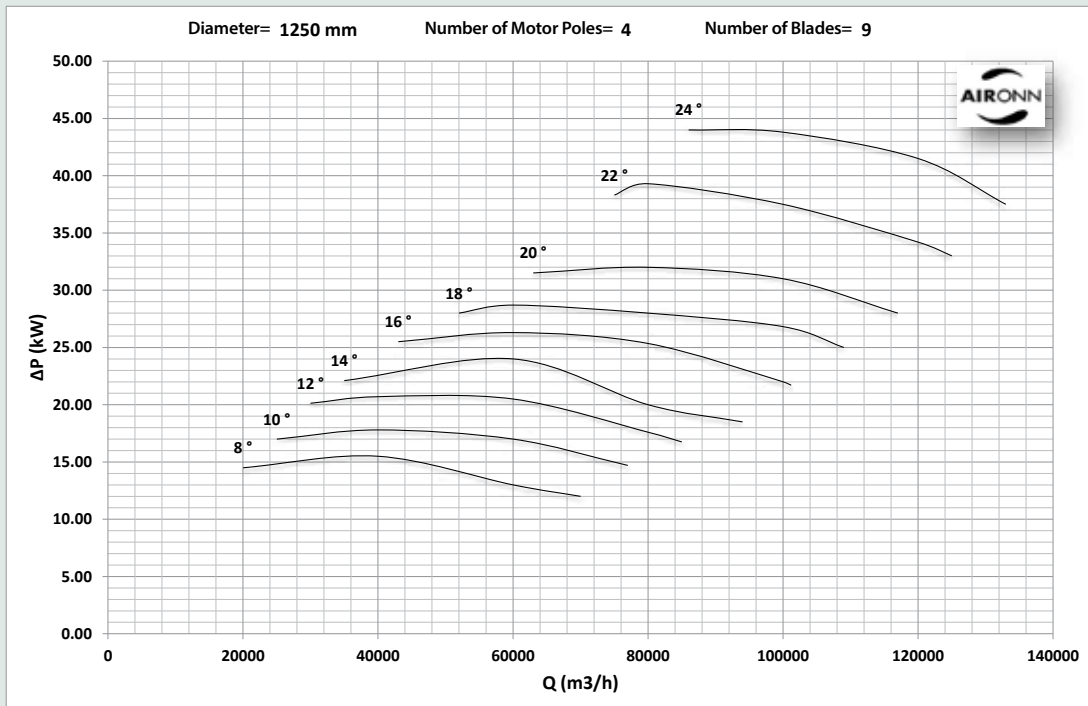
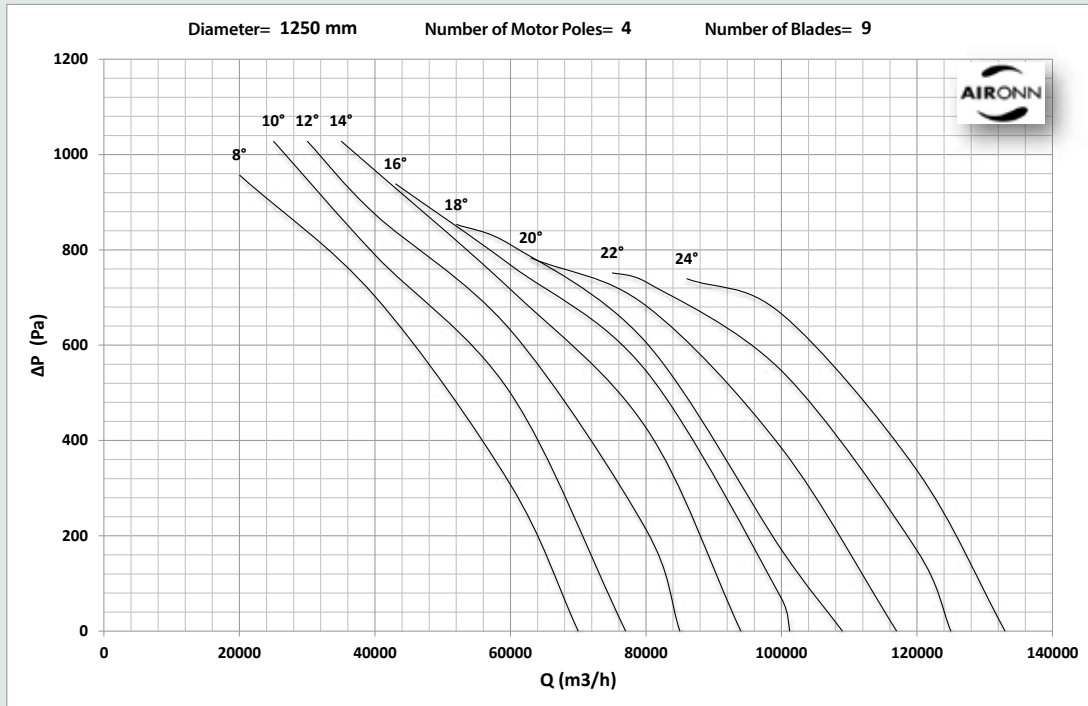

# Roof Type Axial (Horizontal) Smoke Exhaust Fan Series

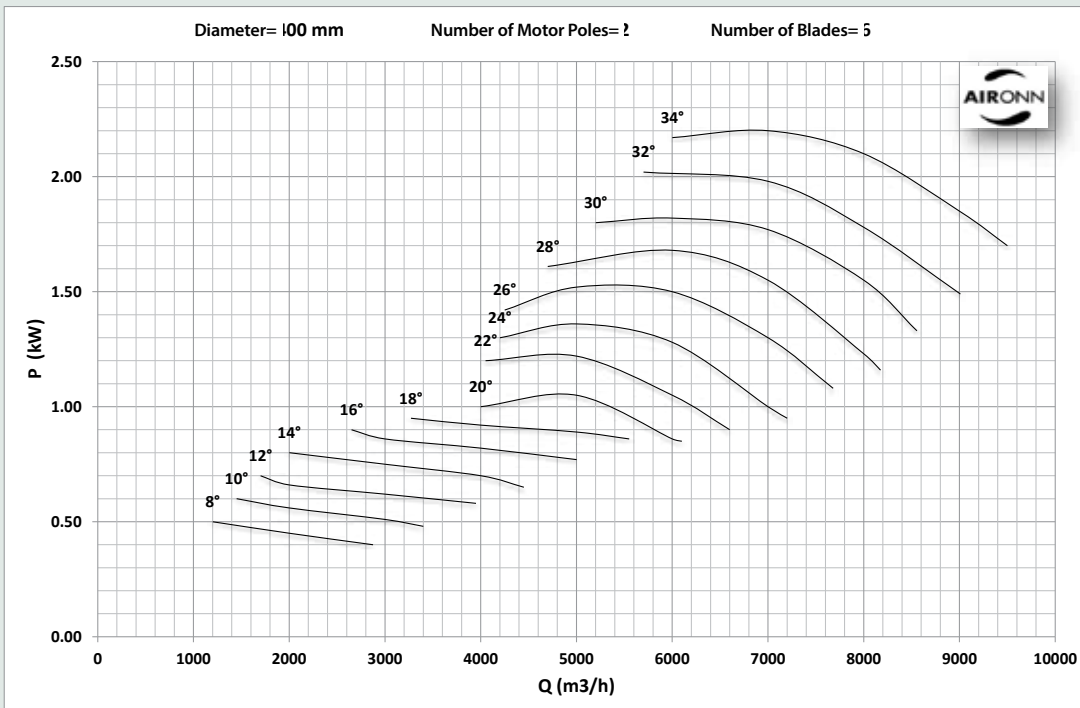
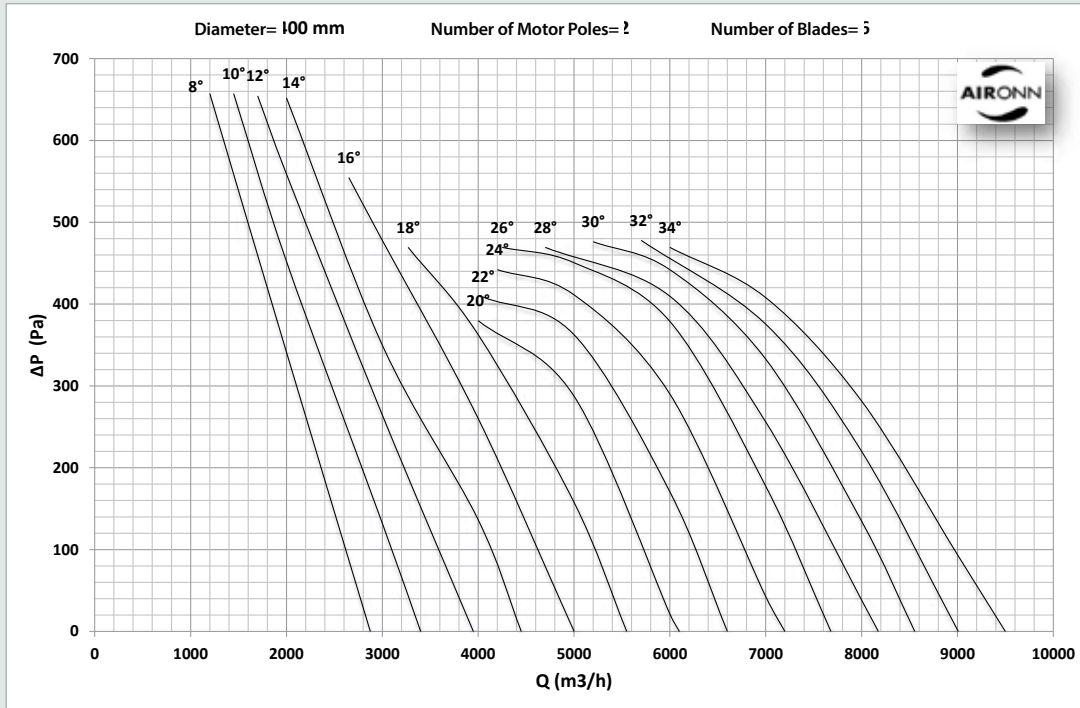

# Roof Type Axial (Horizontal) Smoke Exhaust Fan Series

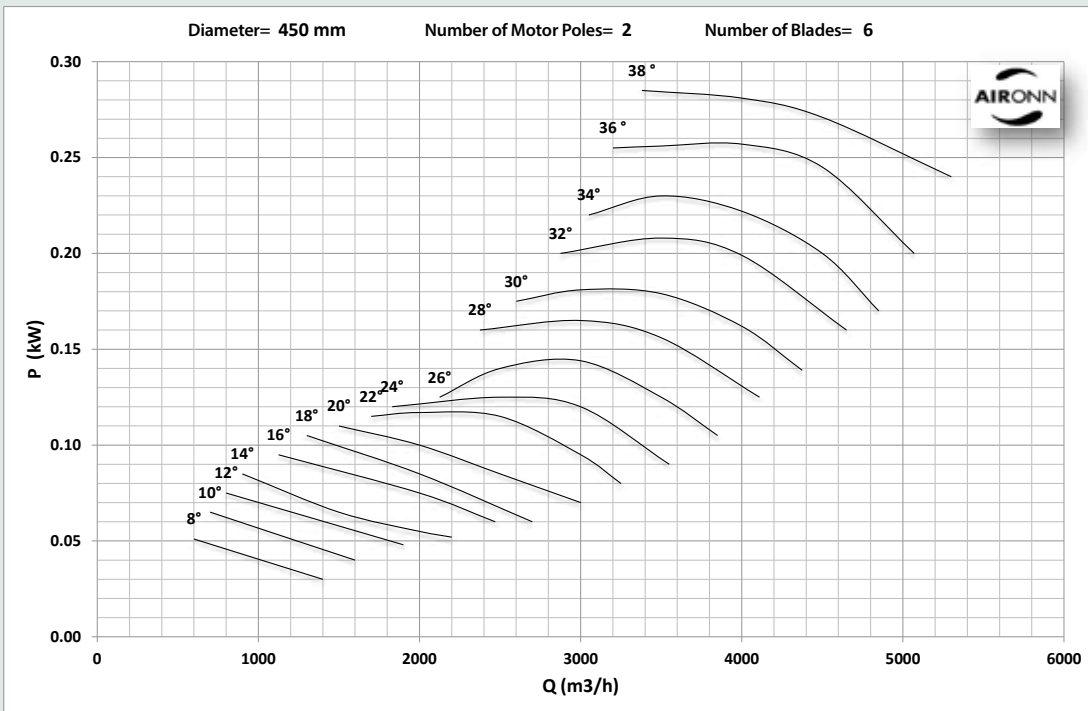
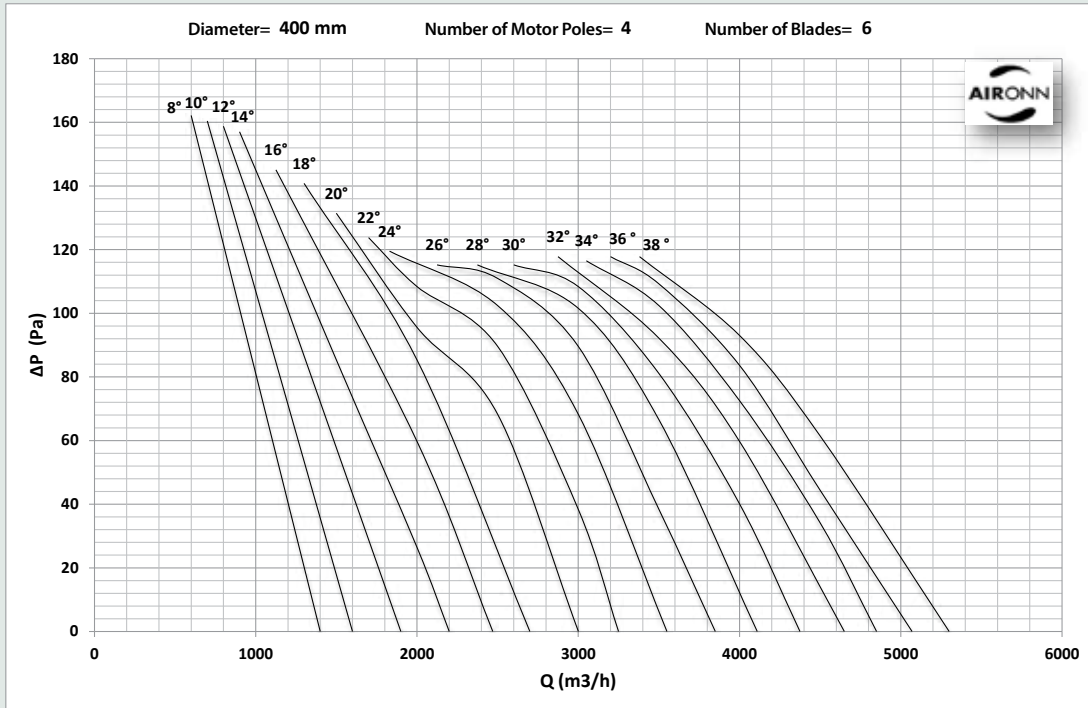

# Roof Type Axial (Horizontal) Smoke Exhaust Fan Series

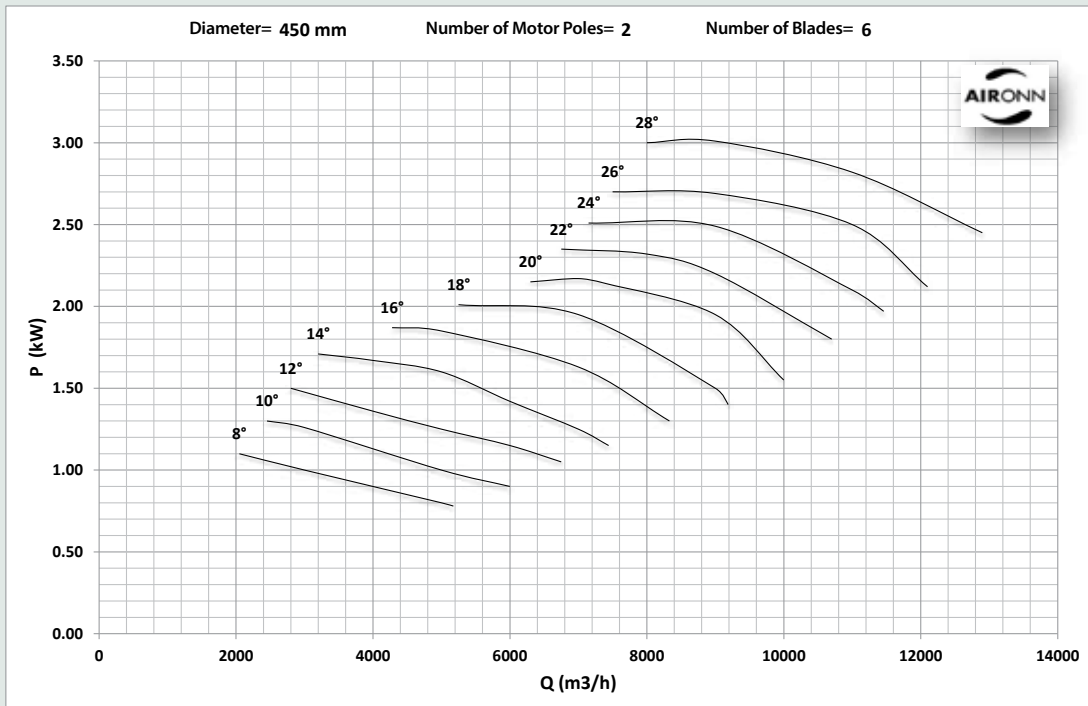
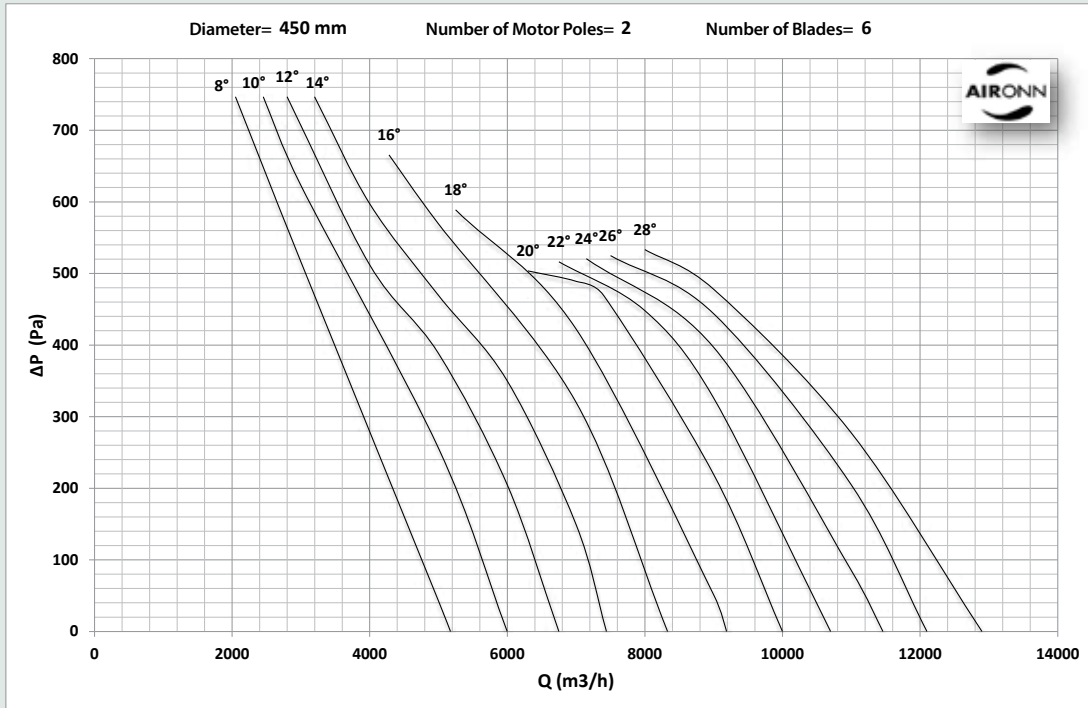

# Roof Type Axial (Horizontal) Smoke Exhaust Fan Series

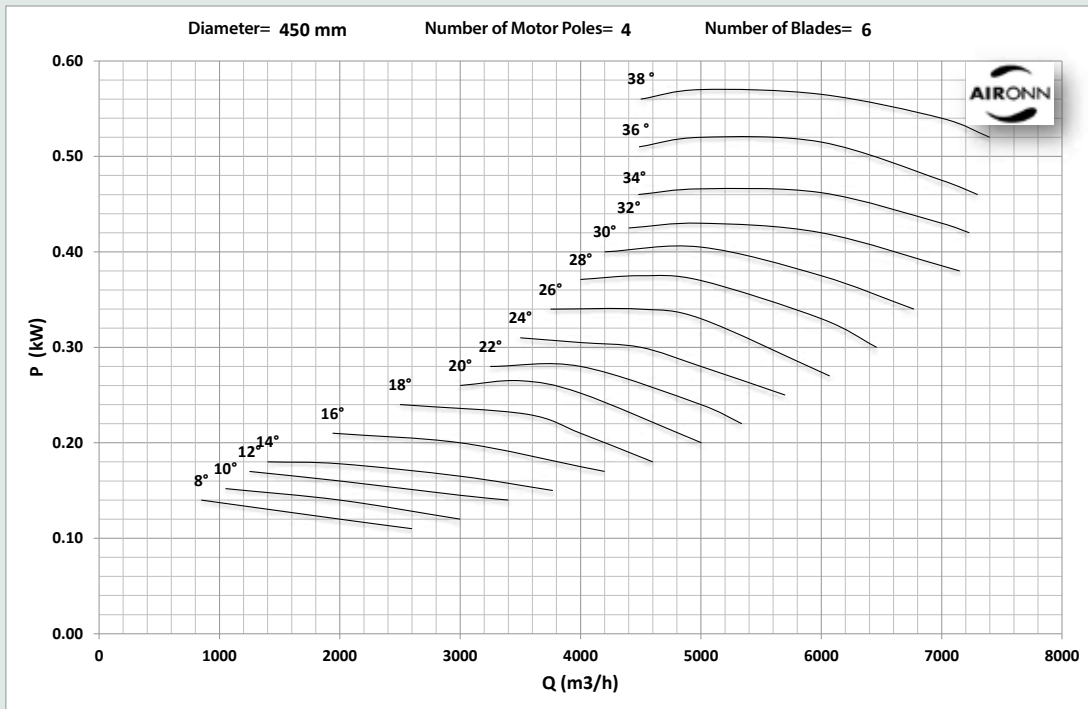
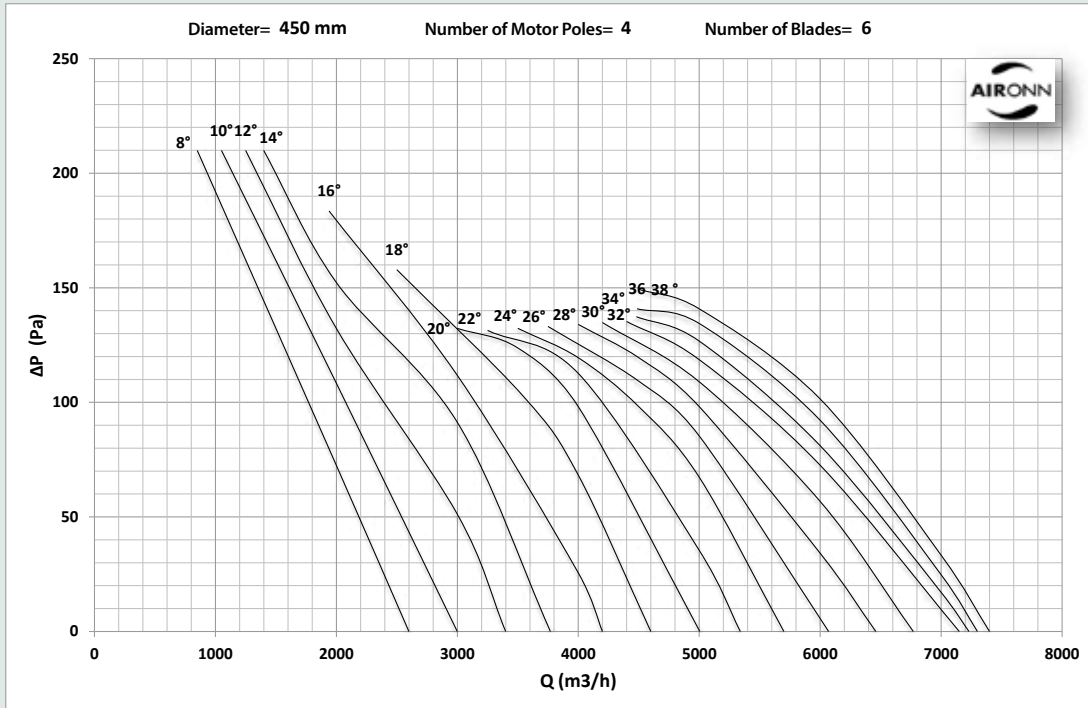



# Roof Type Axial (Horizontal) Smoke Exhaust Fan Series

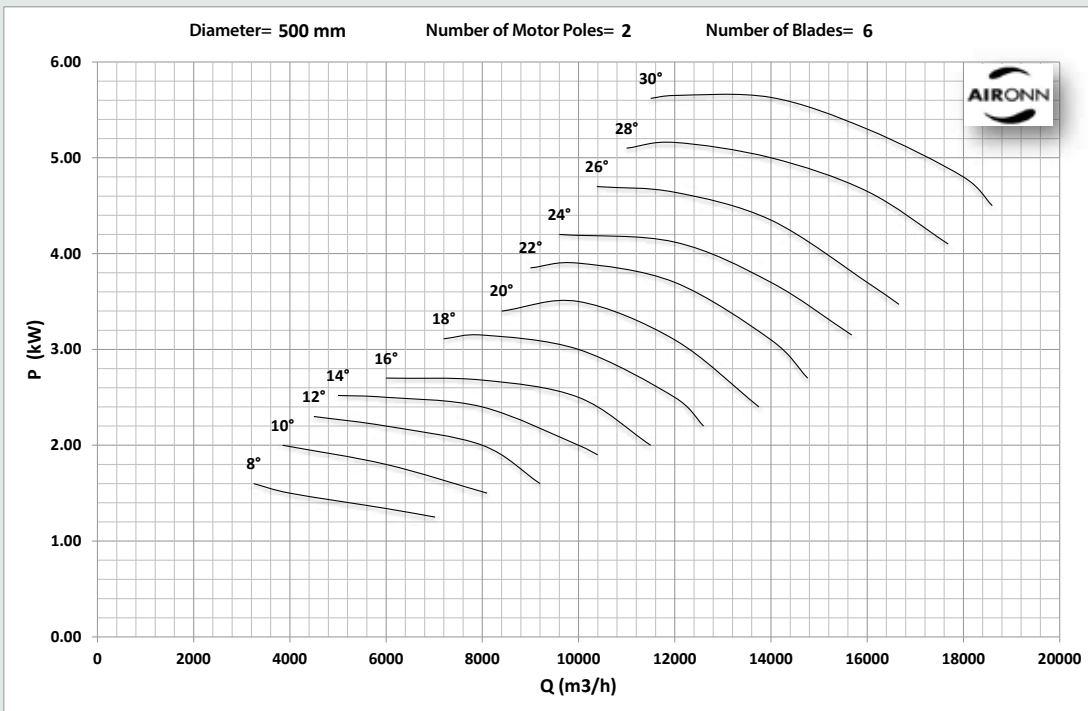
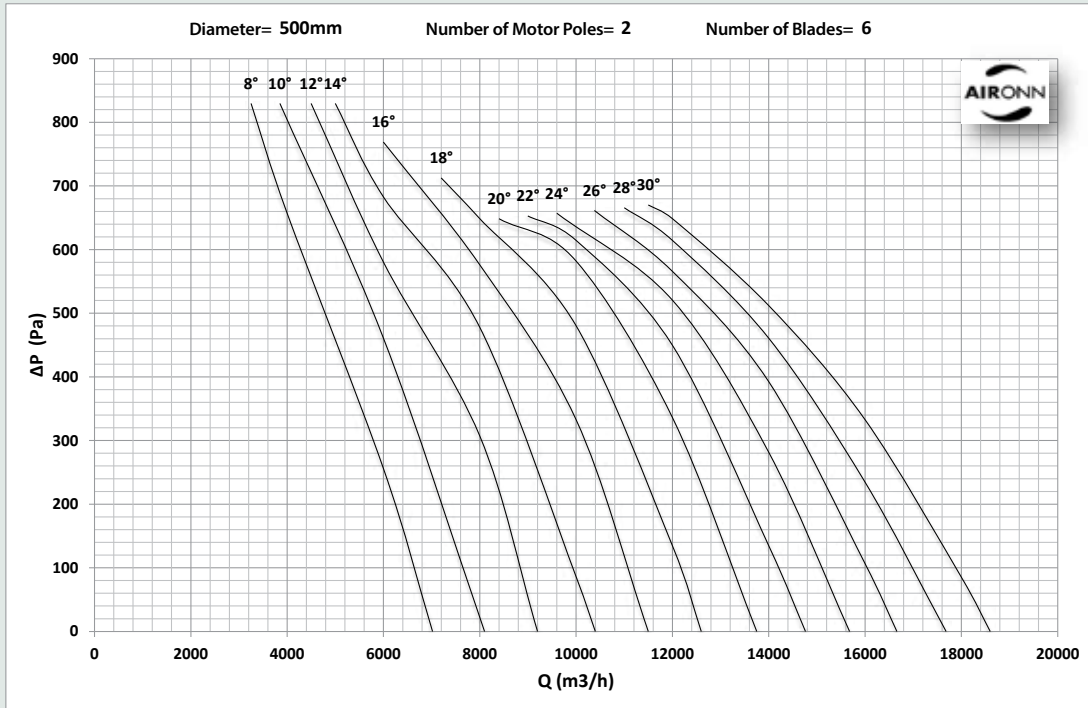

# Roof Type Axial (Horizontal) Smoke Exhaust Fan Series

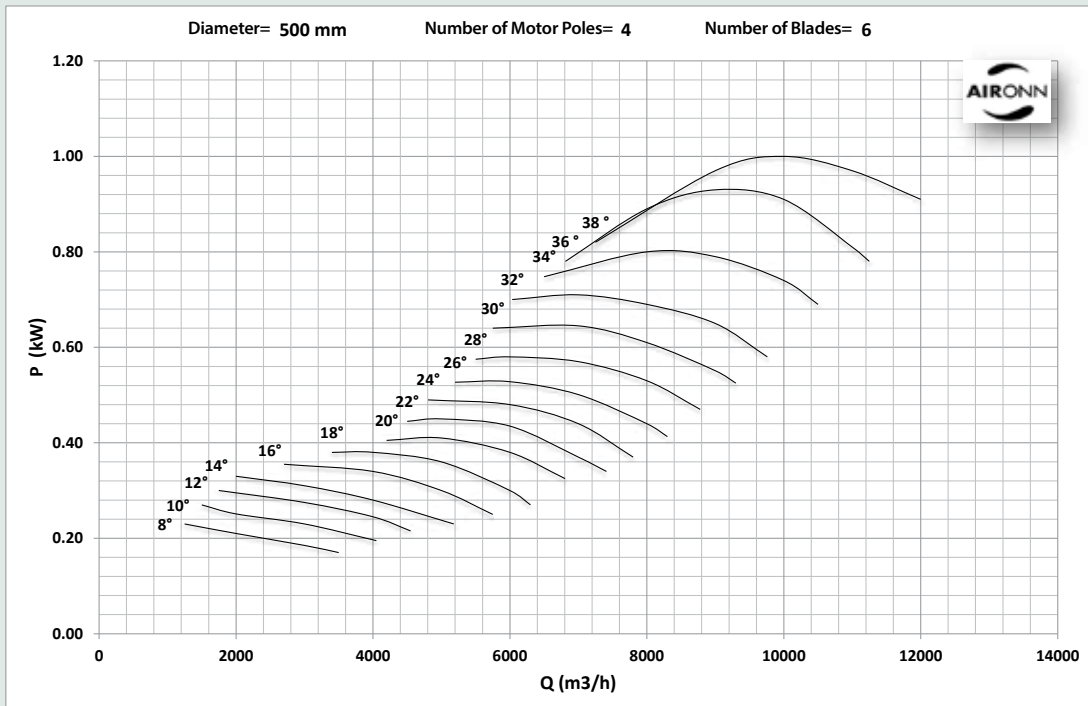
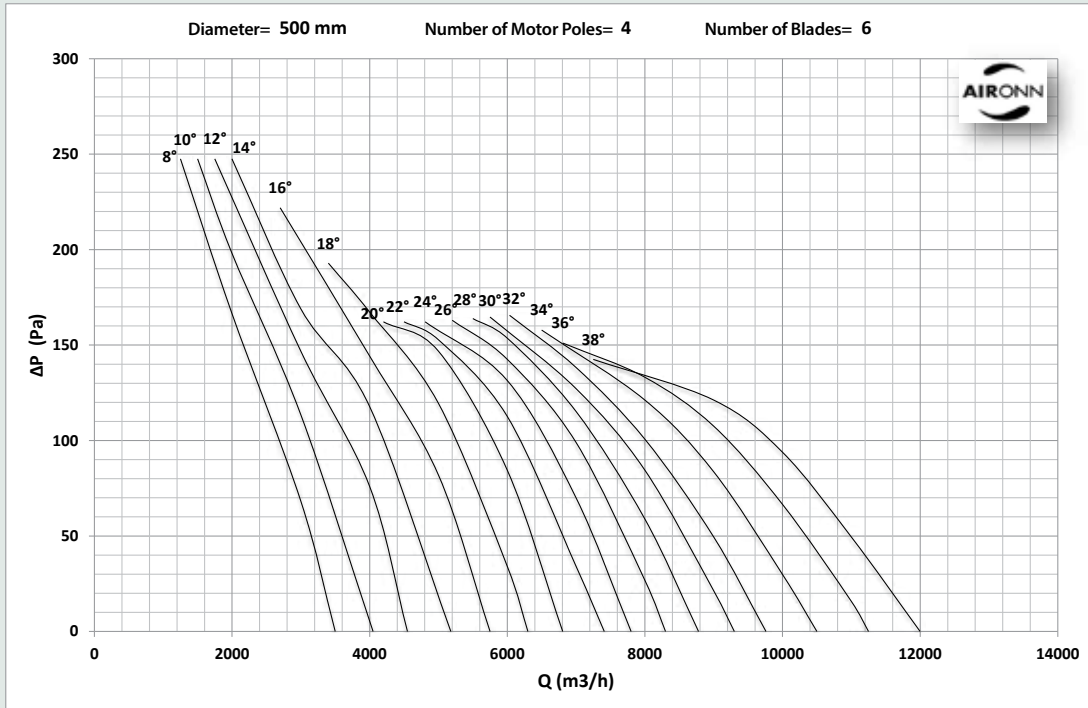

# Roof Type Axial (Horizontal) Smoke Exhaust Fan Series

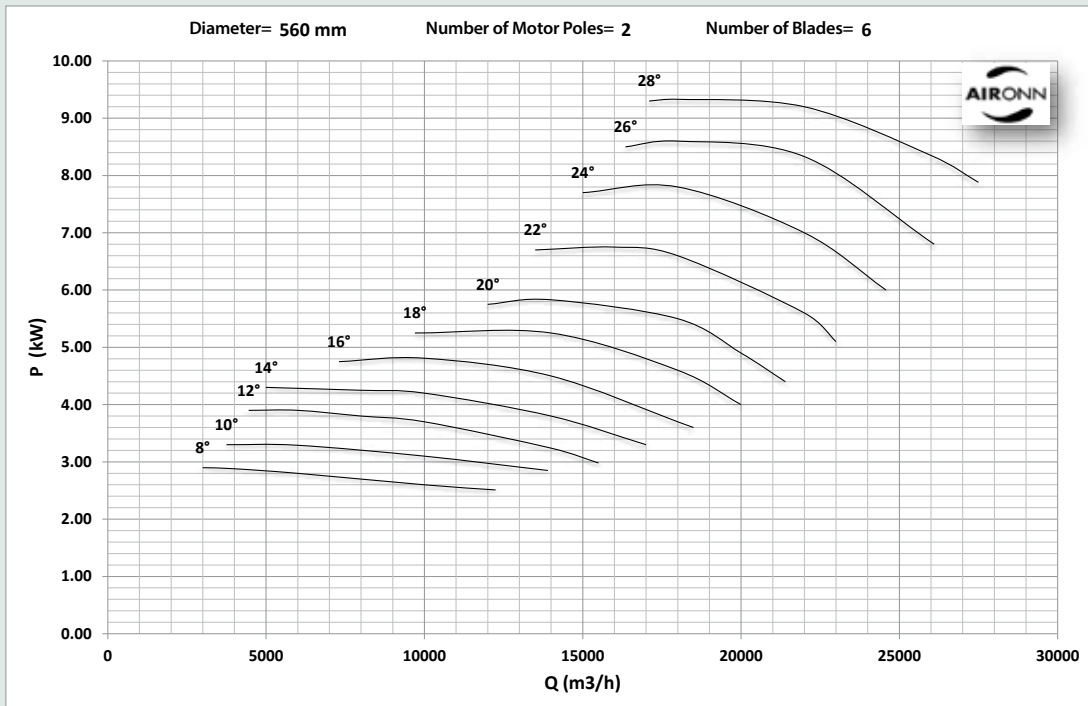
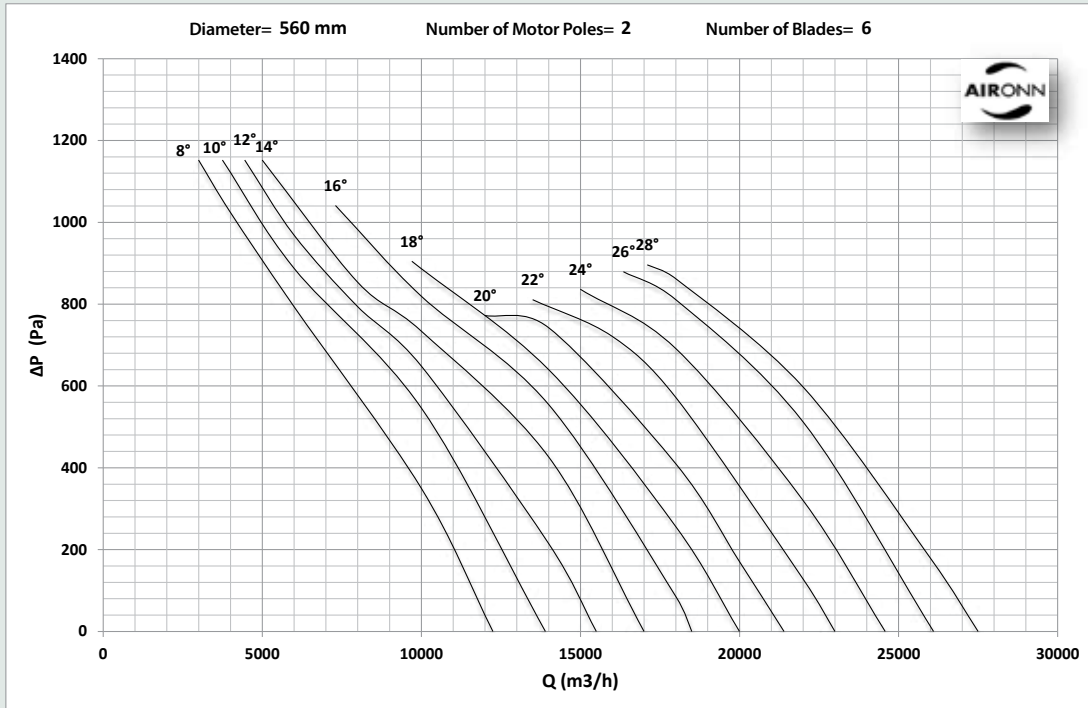

# Roof Type Axial (Horizontal) Smoke Exhaust Fan Series

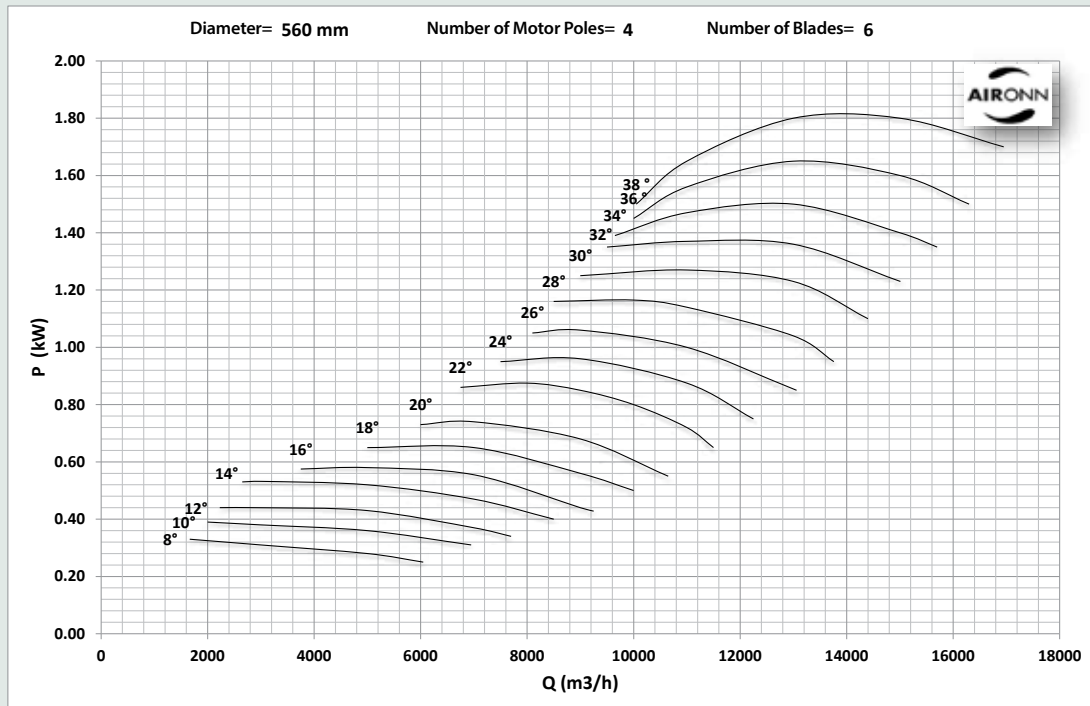
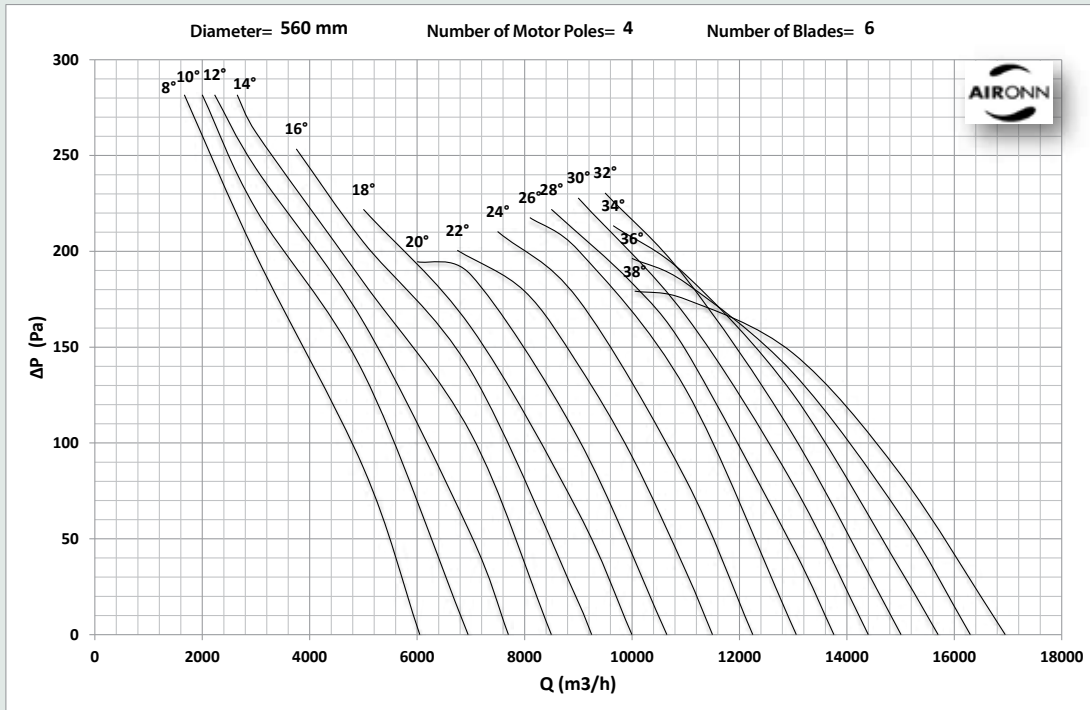

# Roof Type Axial (Horizontal) Smoke Exhaust Fan Series

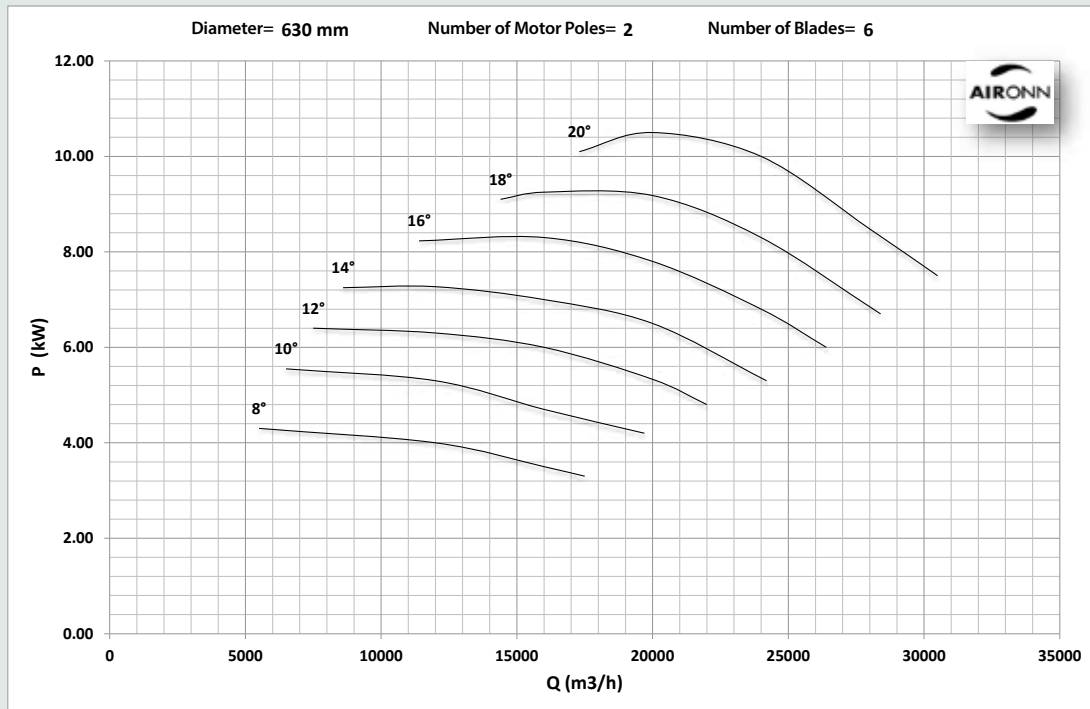
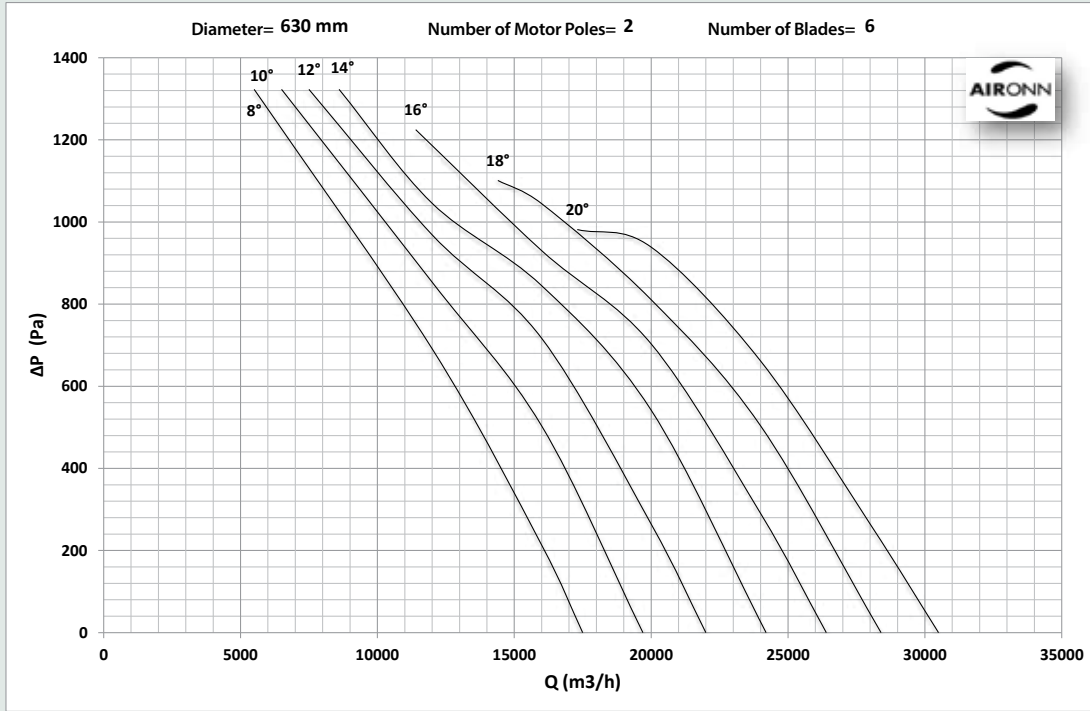

# Roof Type Axial (Horizontal) Smoke Exhaust Fan Series

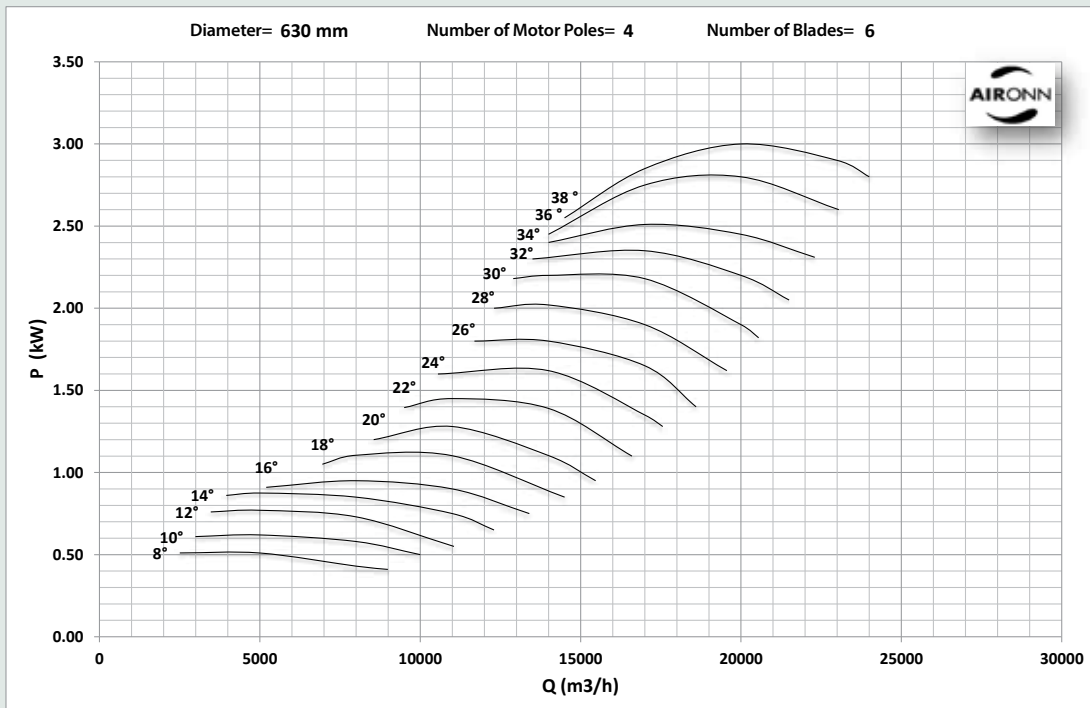
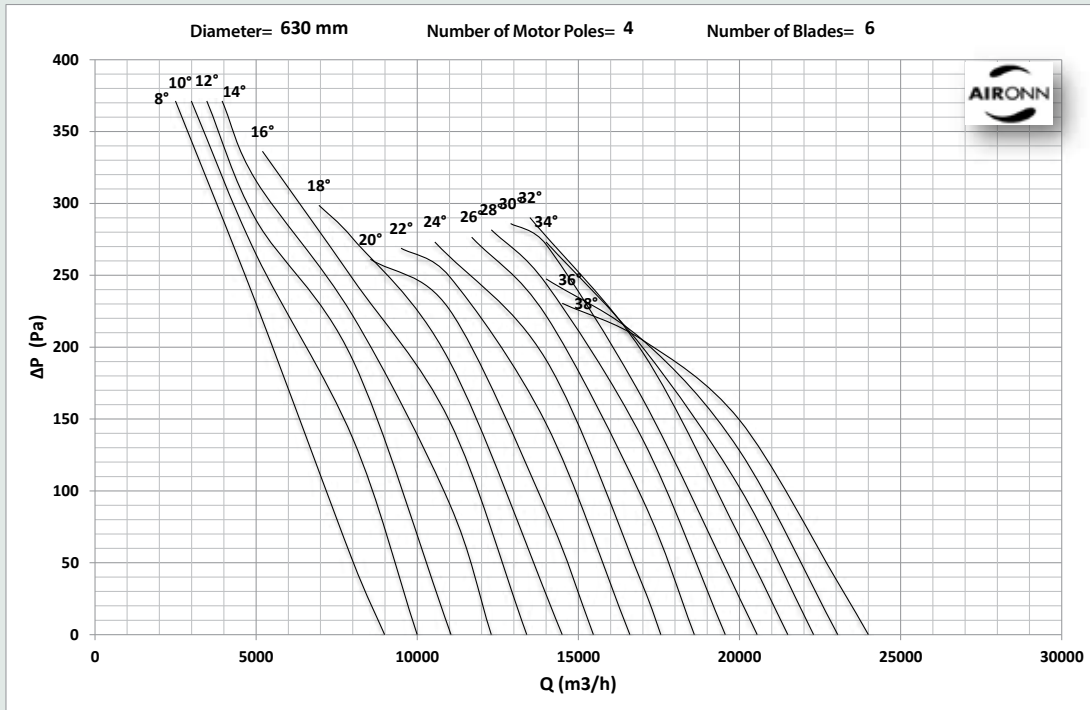

# Roof Type Axial (Horizontal) Smoke Exhaust Fan Series

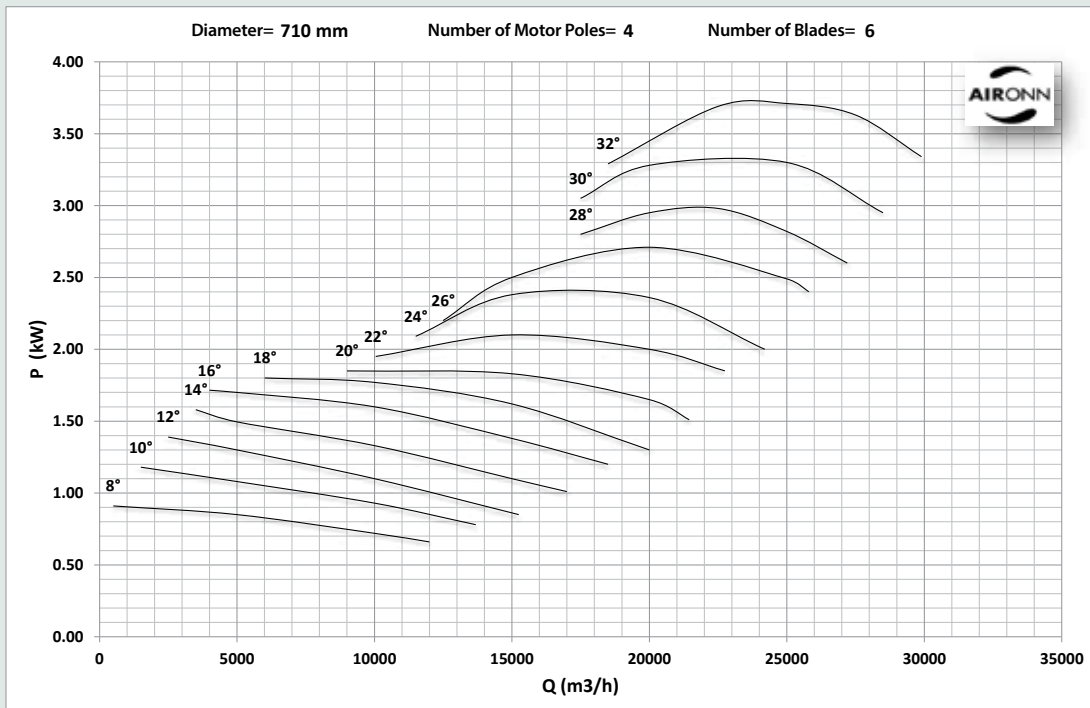
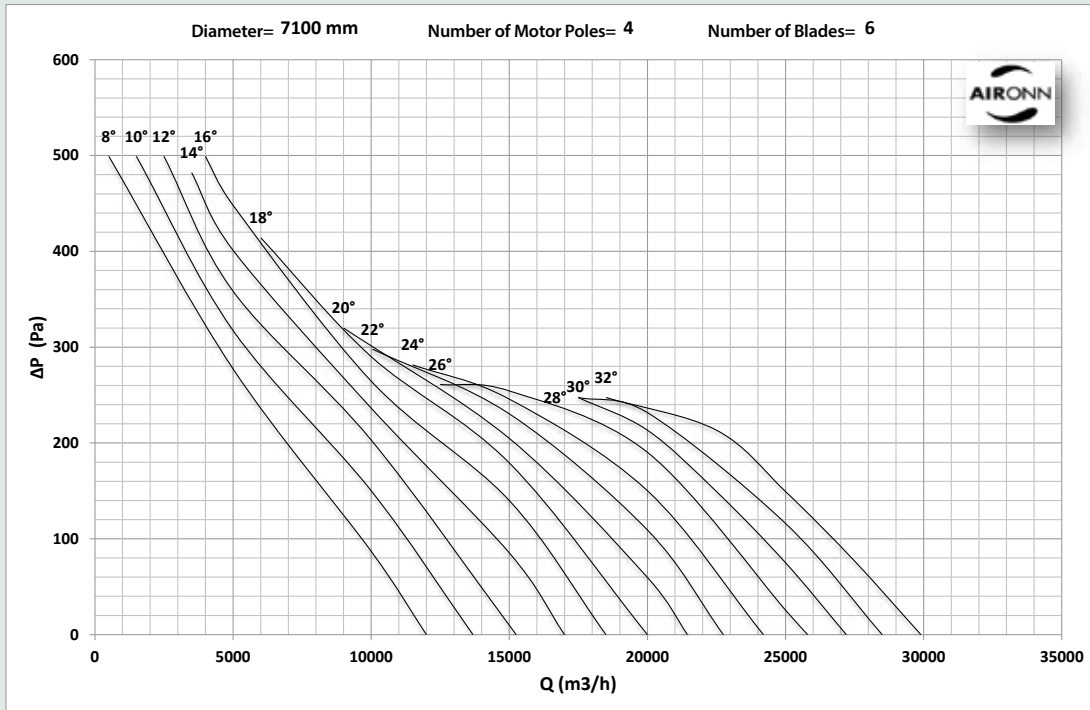

# Roof Type Axial (Horizontal) Smoke Exhaust Fan Series

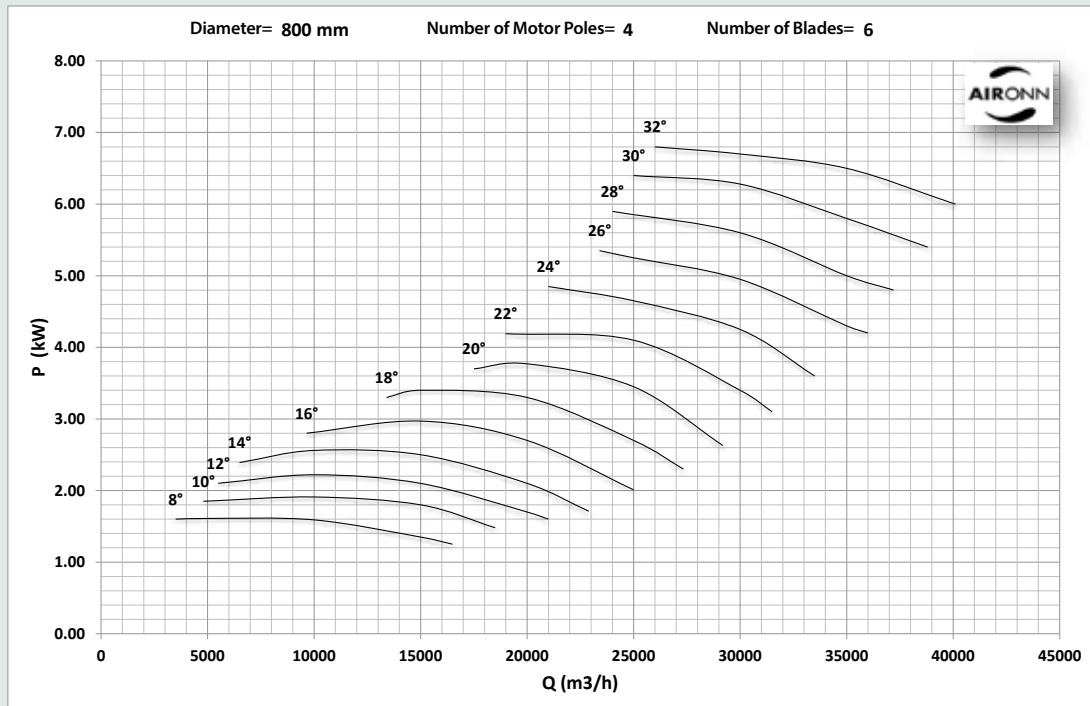
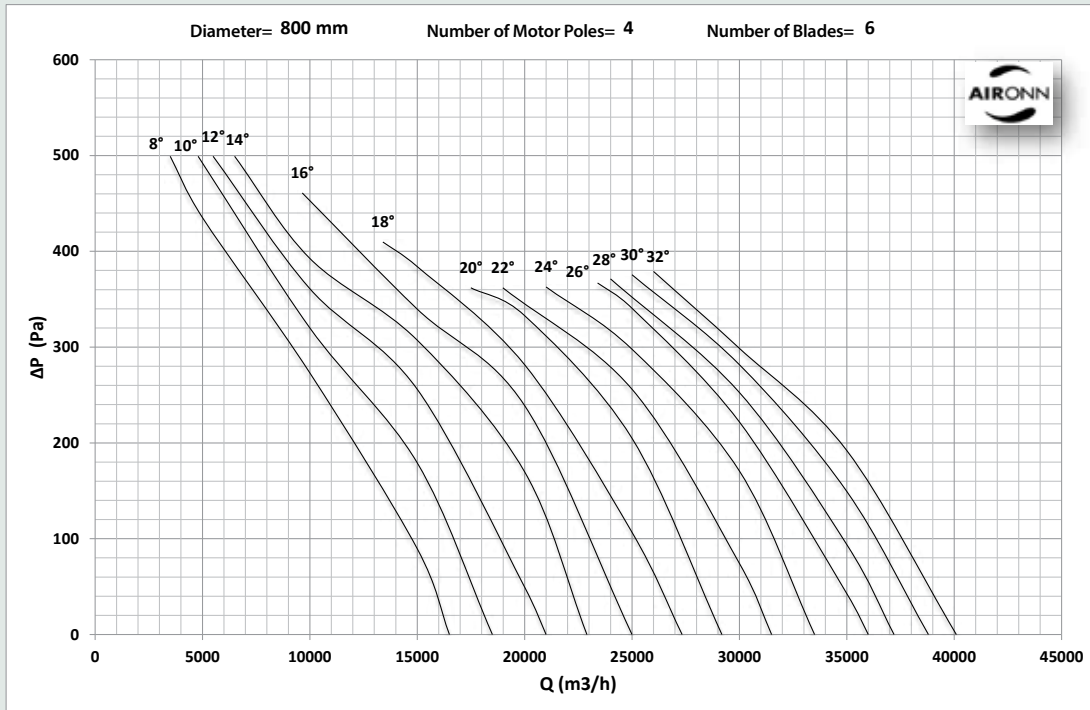



# Roof Type Axial (Horizontal) Smoke Exhaust Fan Series

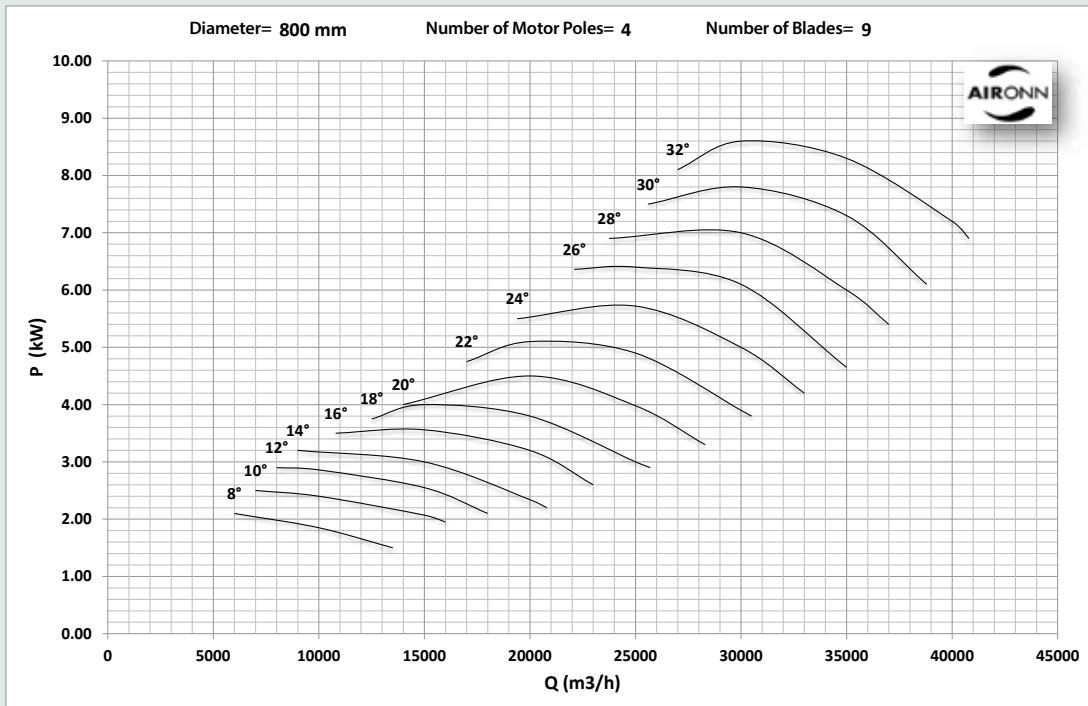
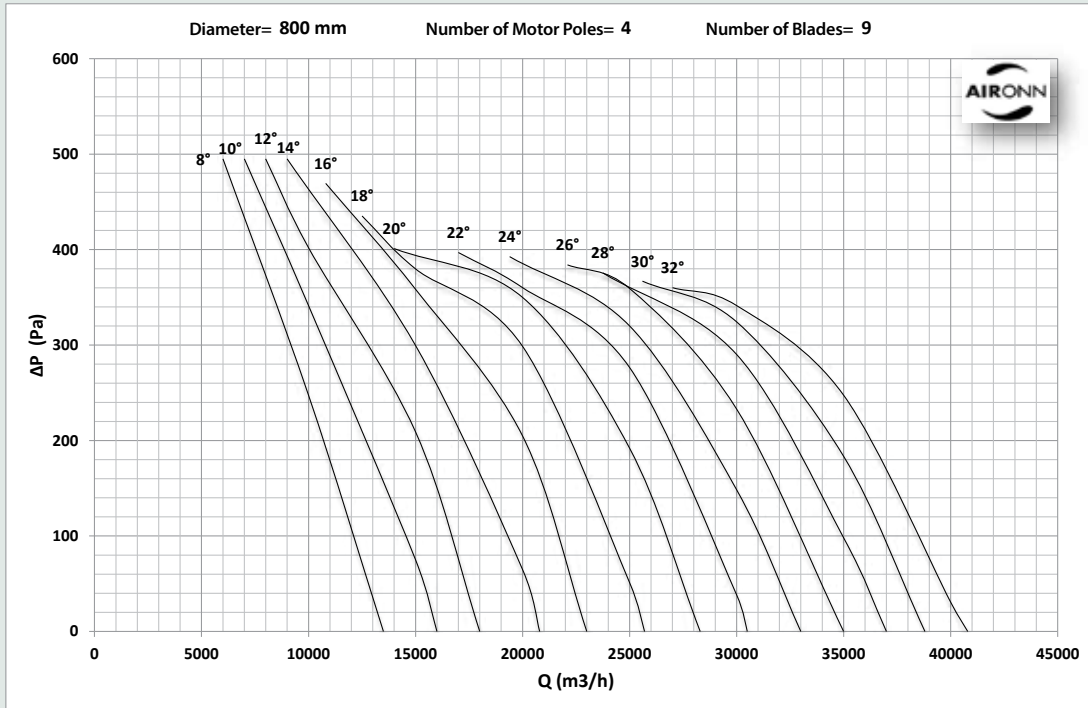

# Roof Type Axial (Horizontal) Smoke Exhaust Fan Series

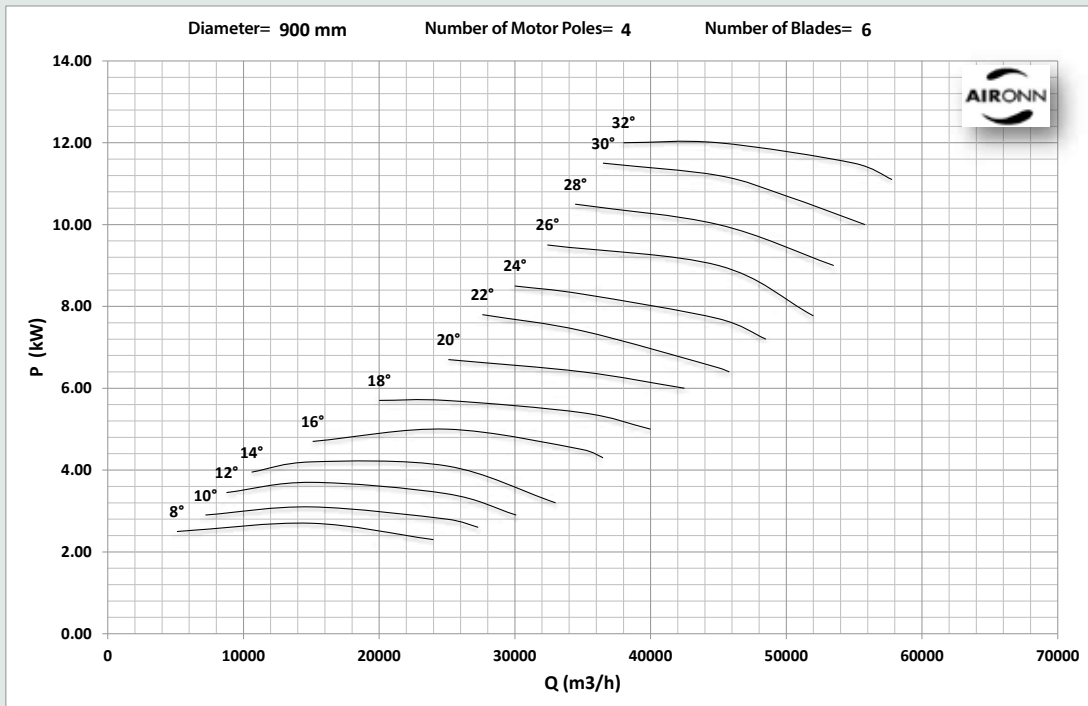
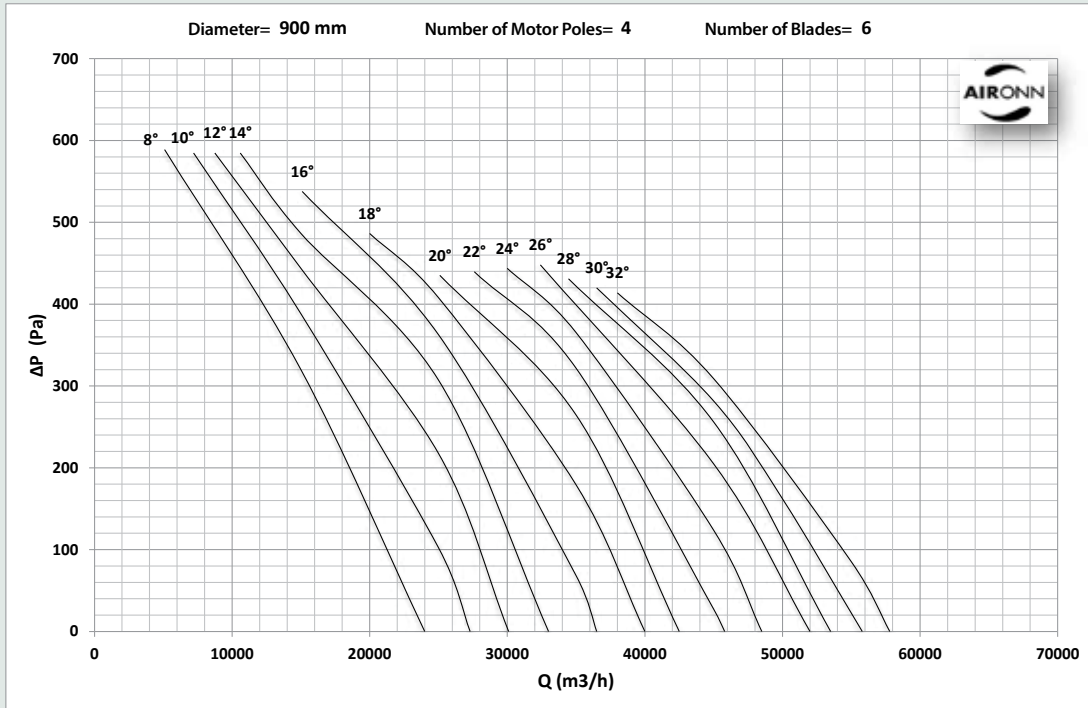

# Roof Type Axial (Horizontal) Smoke Exhaust Fan Series

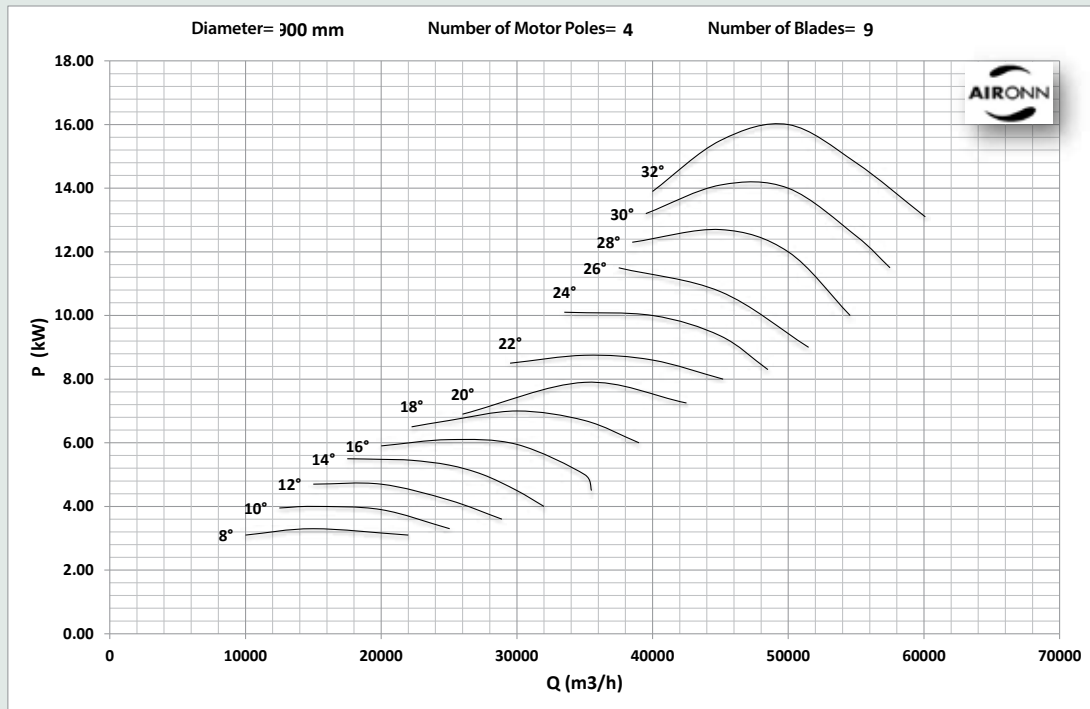
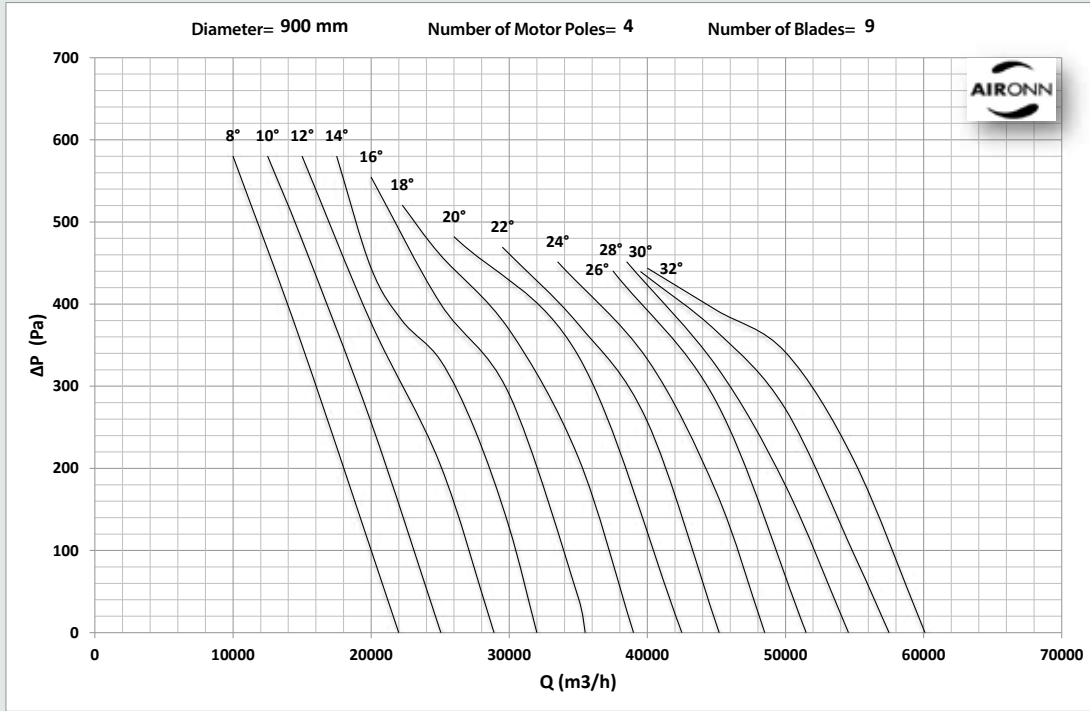

# Roof Type Axial (Horizontal) Smoke Exhaust Fan Series

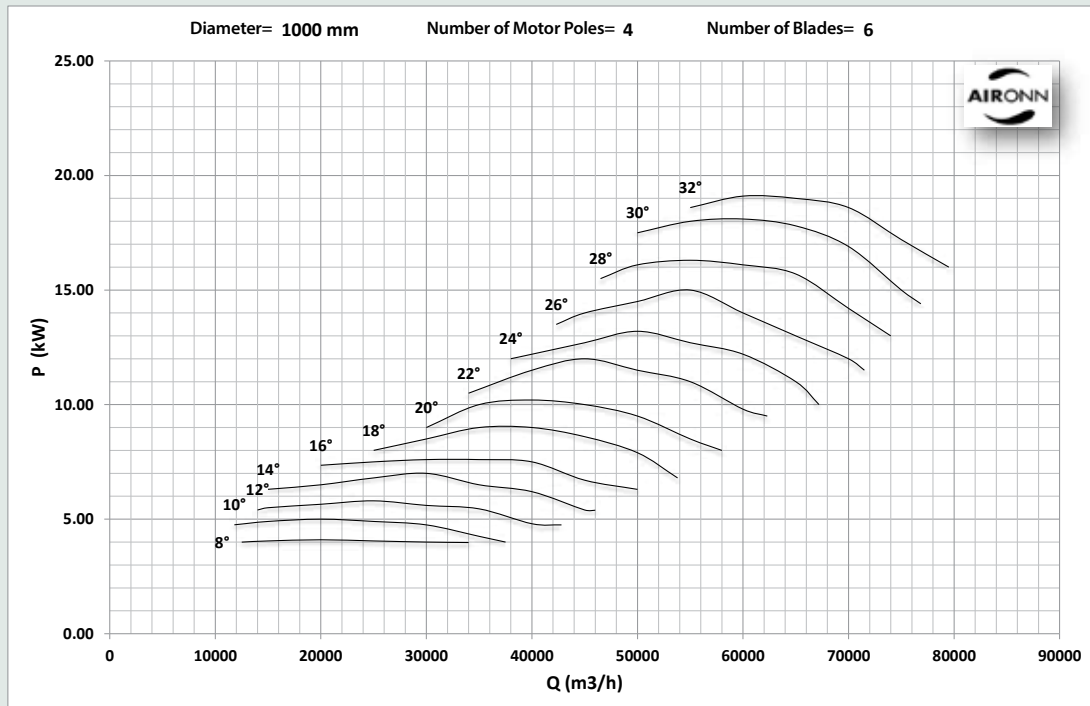
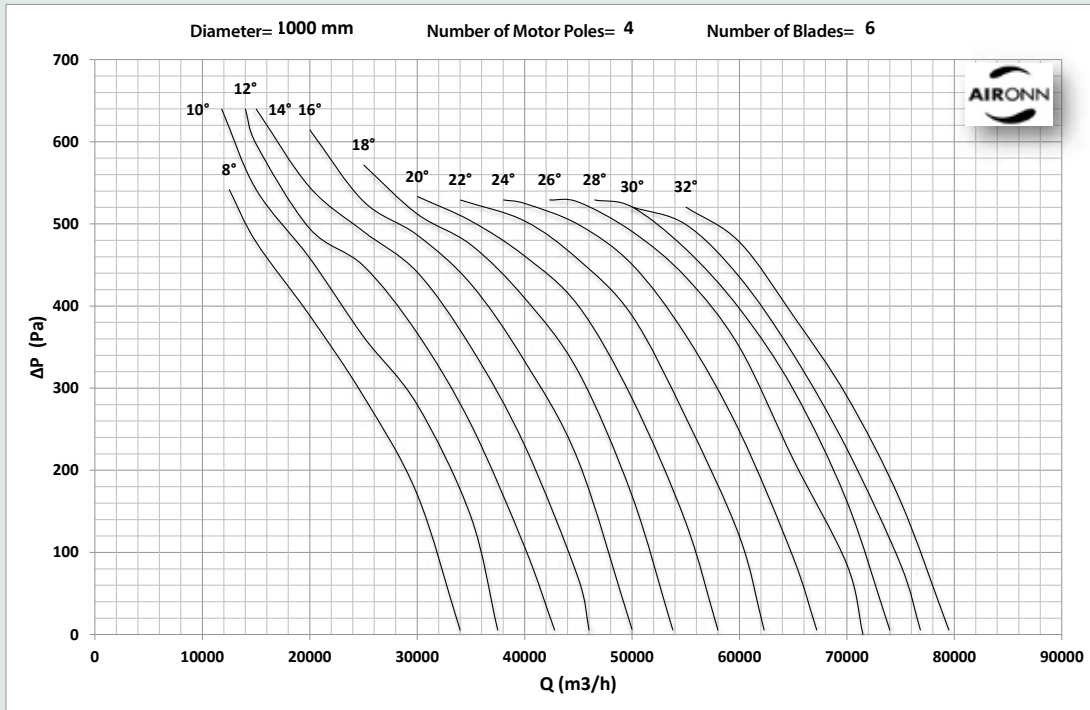

# Roof Type Axial (Horizontal) Smoke Exhaust Fan Series

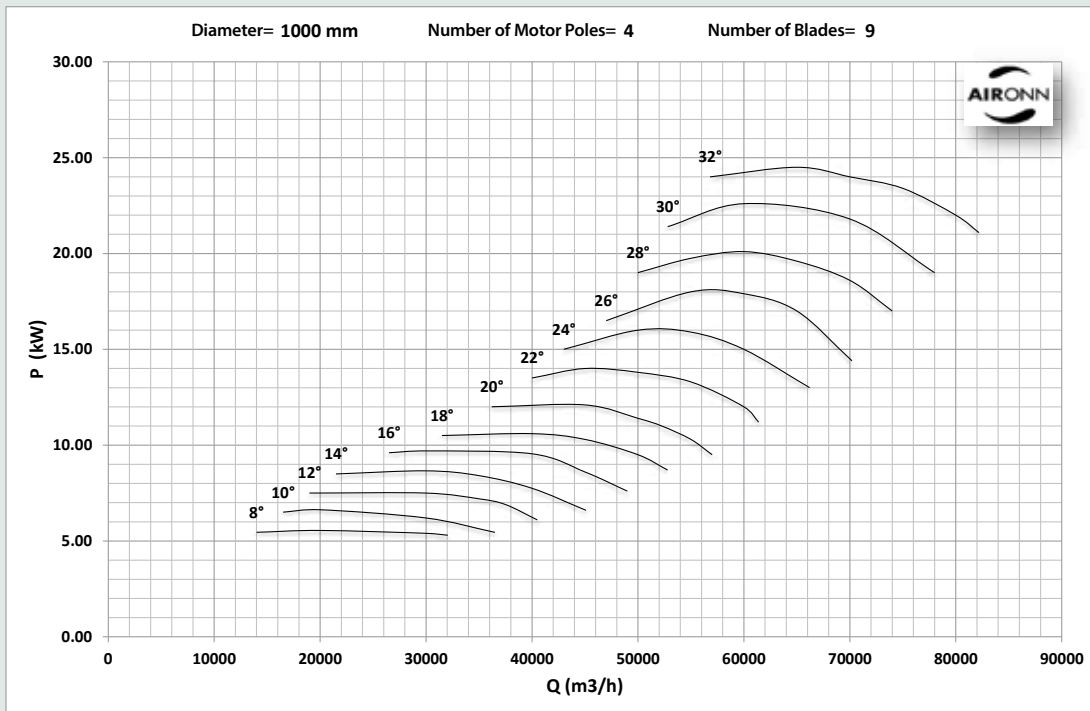
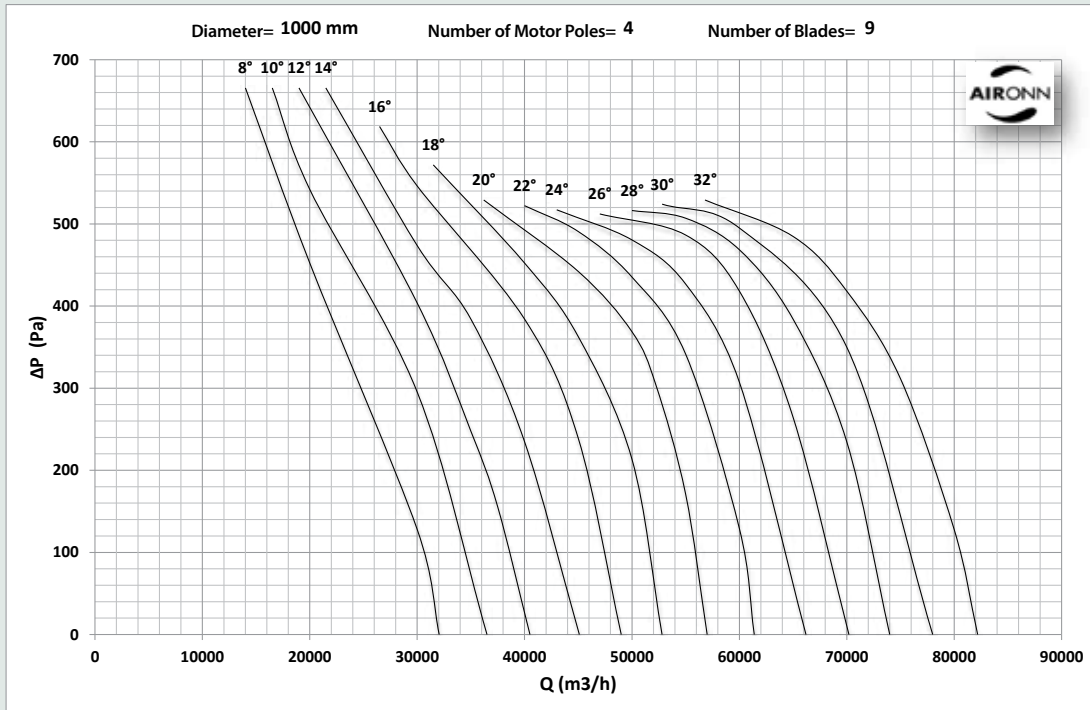

# Roof Type Axial (Horizontal) Smoke Exhaust Fan Series

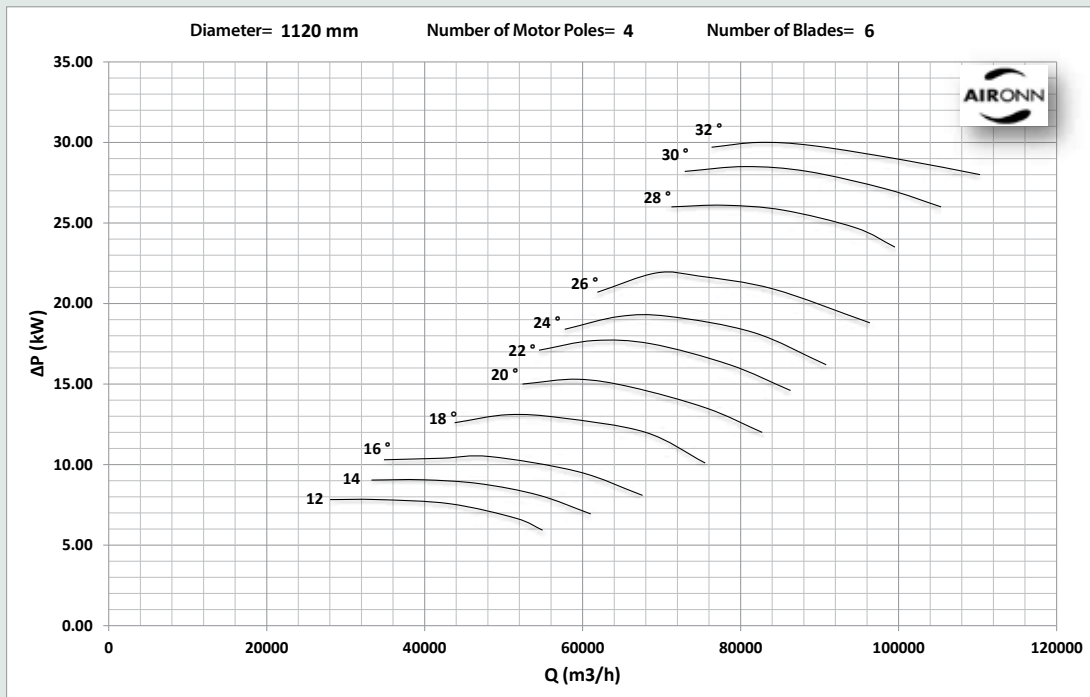
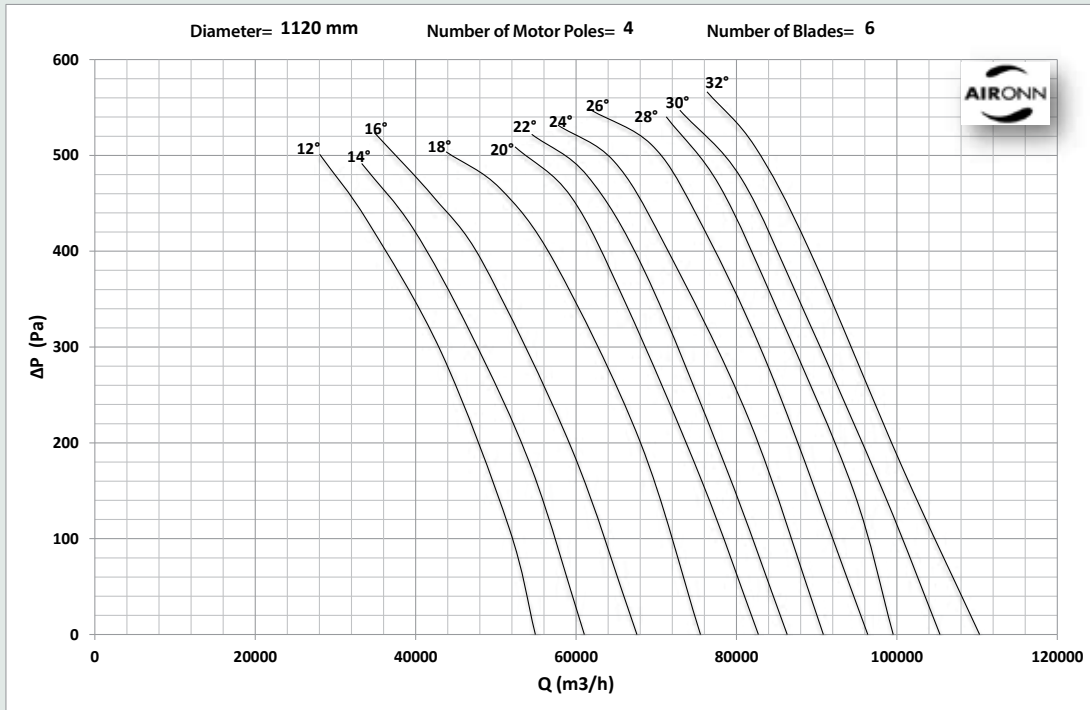

# Roof Type Axial (Horizontal) Smoke Exhaust Fan Series

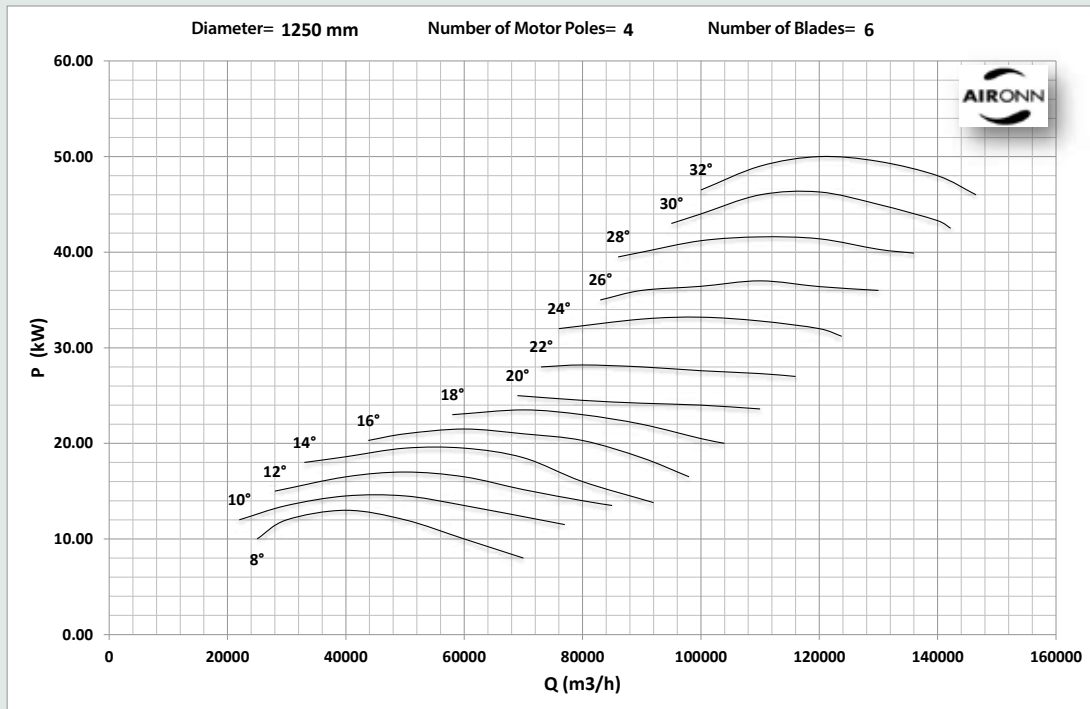
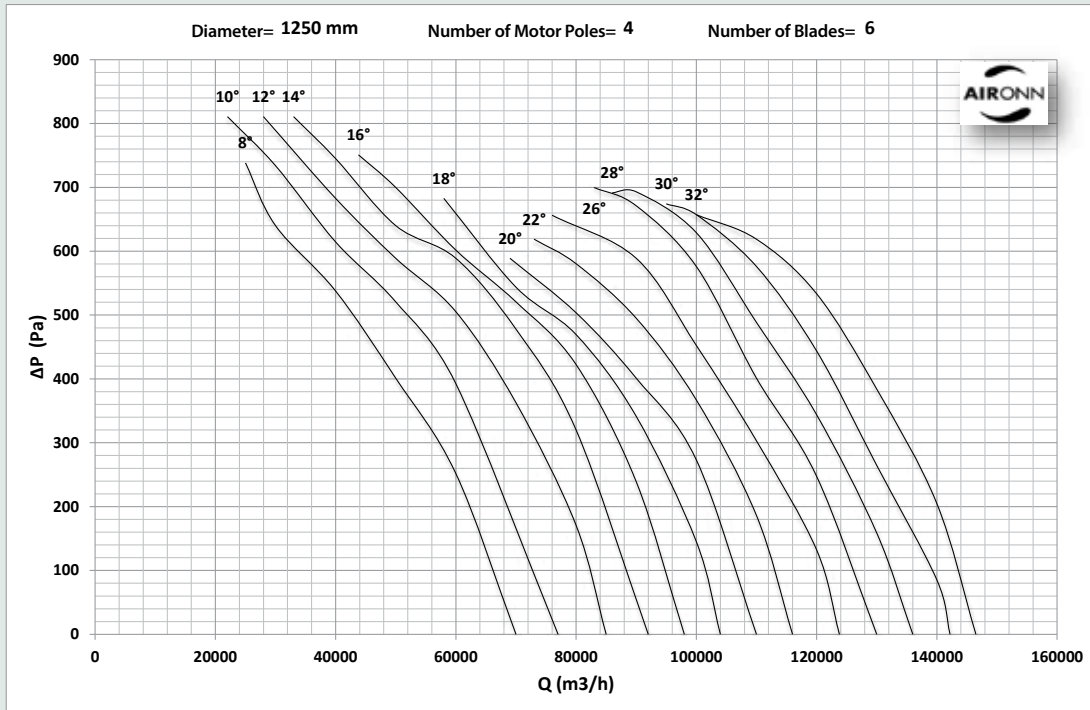

# Roof Type Axial (Horizontal) Smoke Exhaust Fan Series

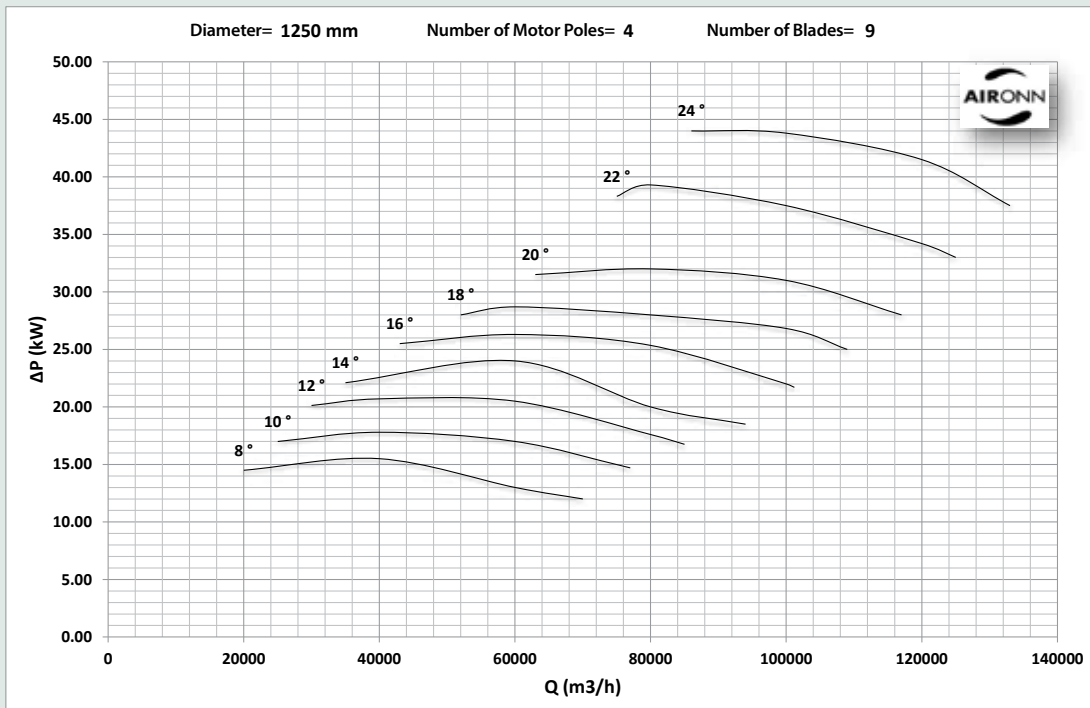
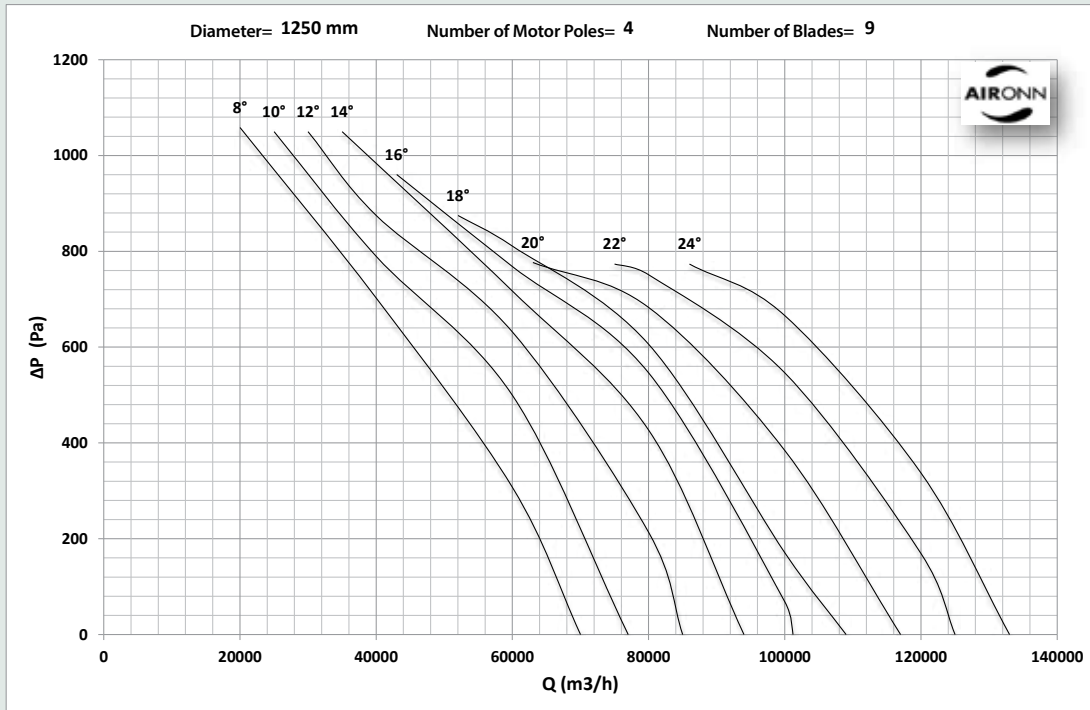



# Roof Type Axial (Horizontal) Smoke Exhaust Fan Series

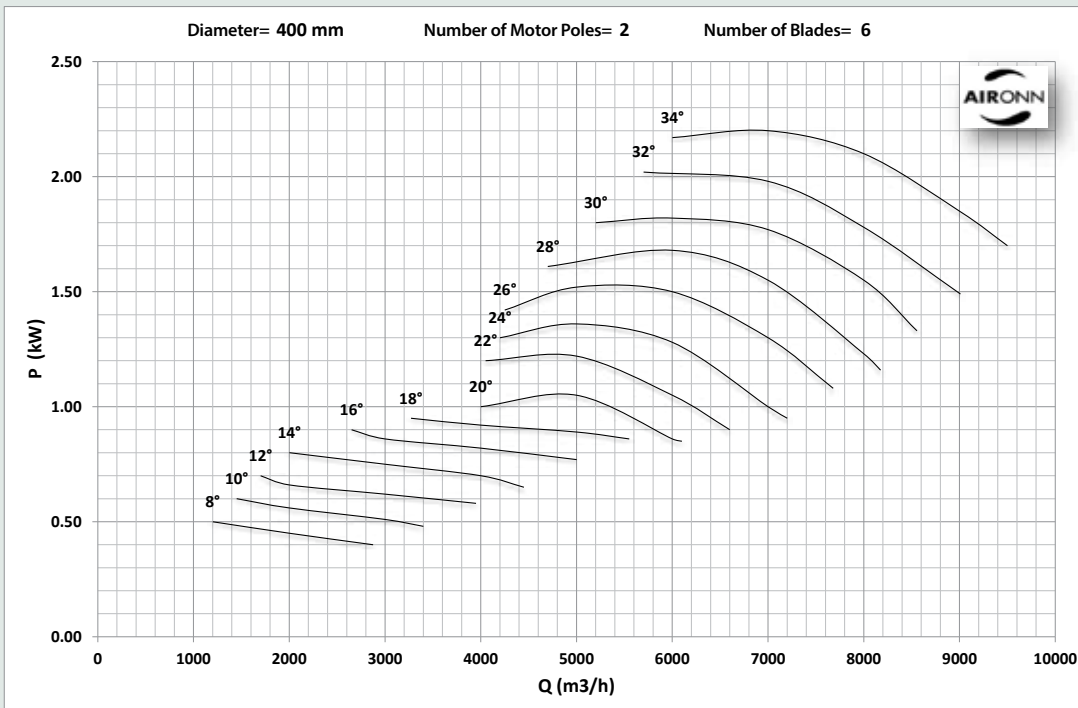
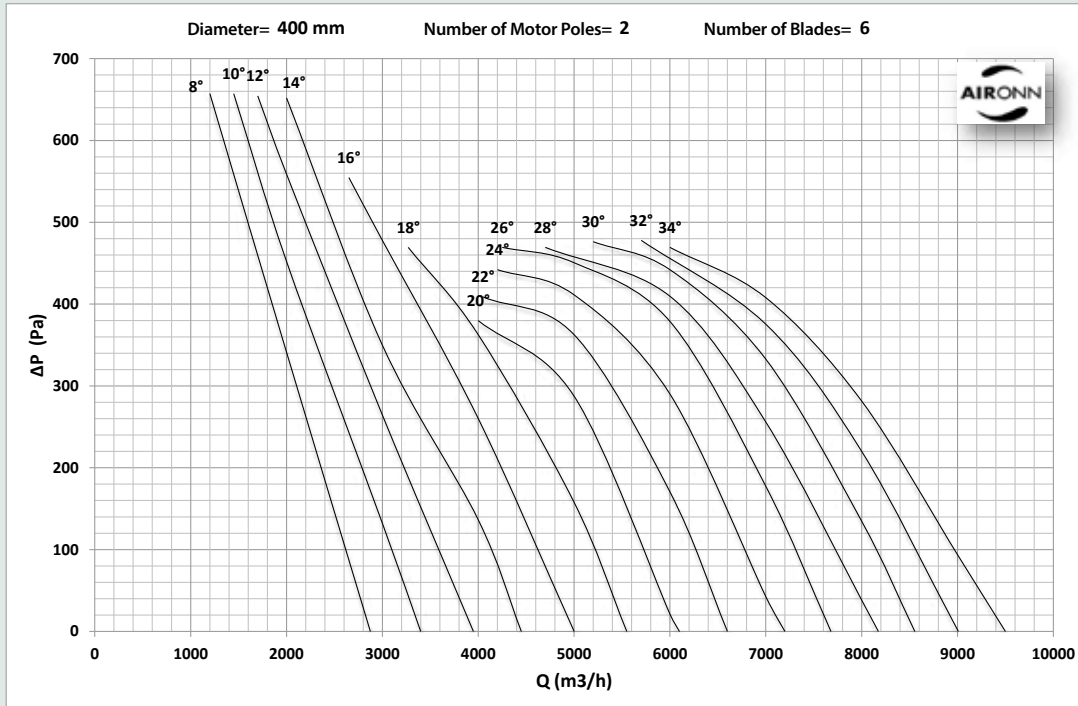

# Roof Type Axial (Horizontal) Smoke Exhaust Fan Series

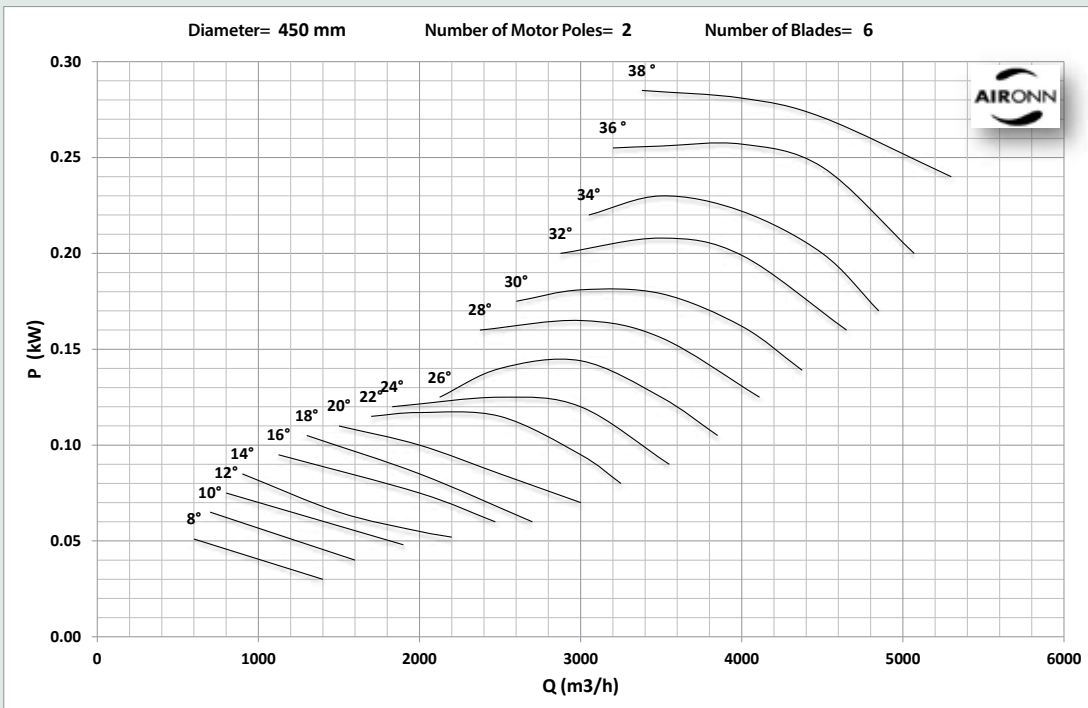
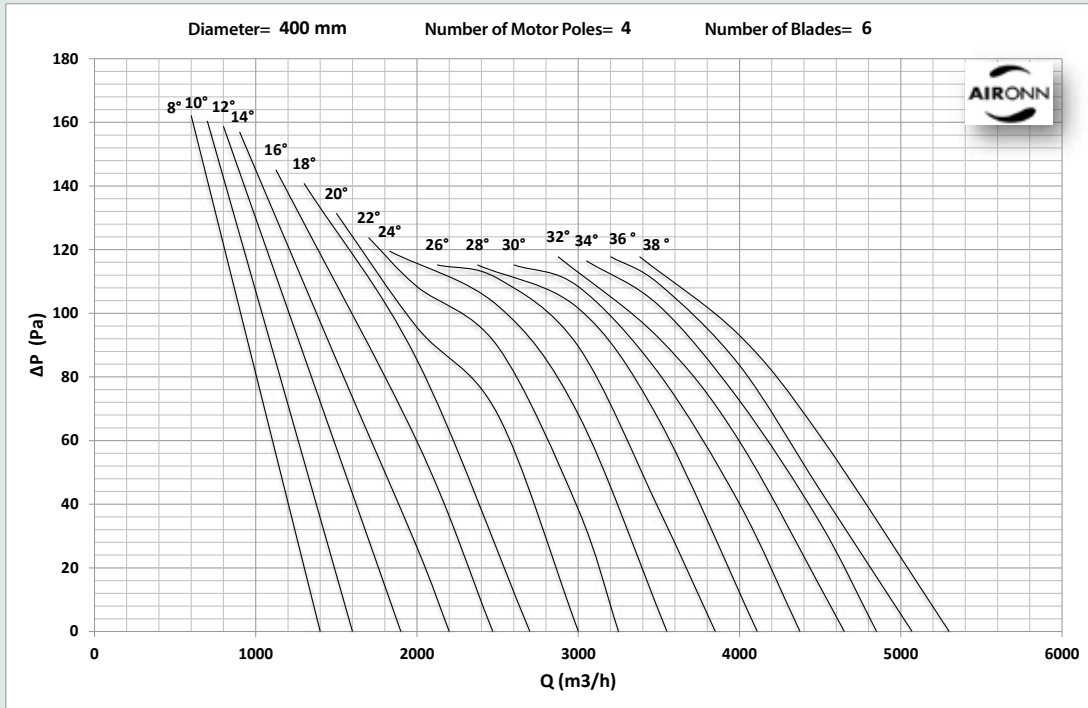

# Roof Type Axial (Horizontal) Smoke Exhaust Fan Series

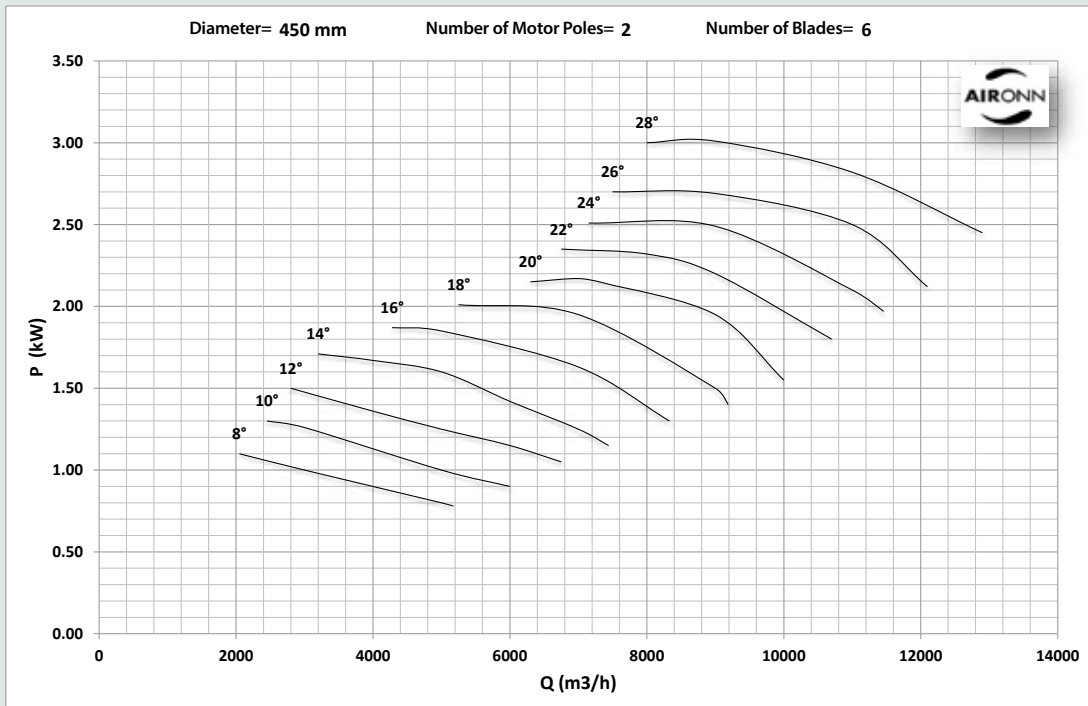
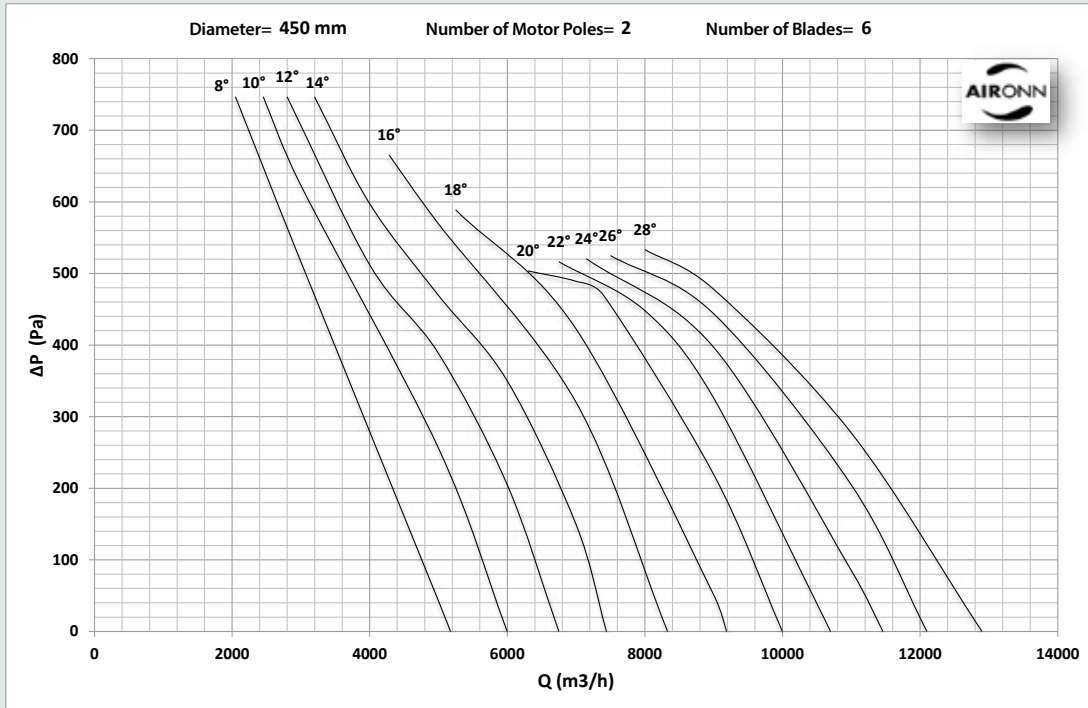

# Roof Type Axial (Horizontal) Smoke Exhaust Fan Series

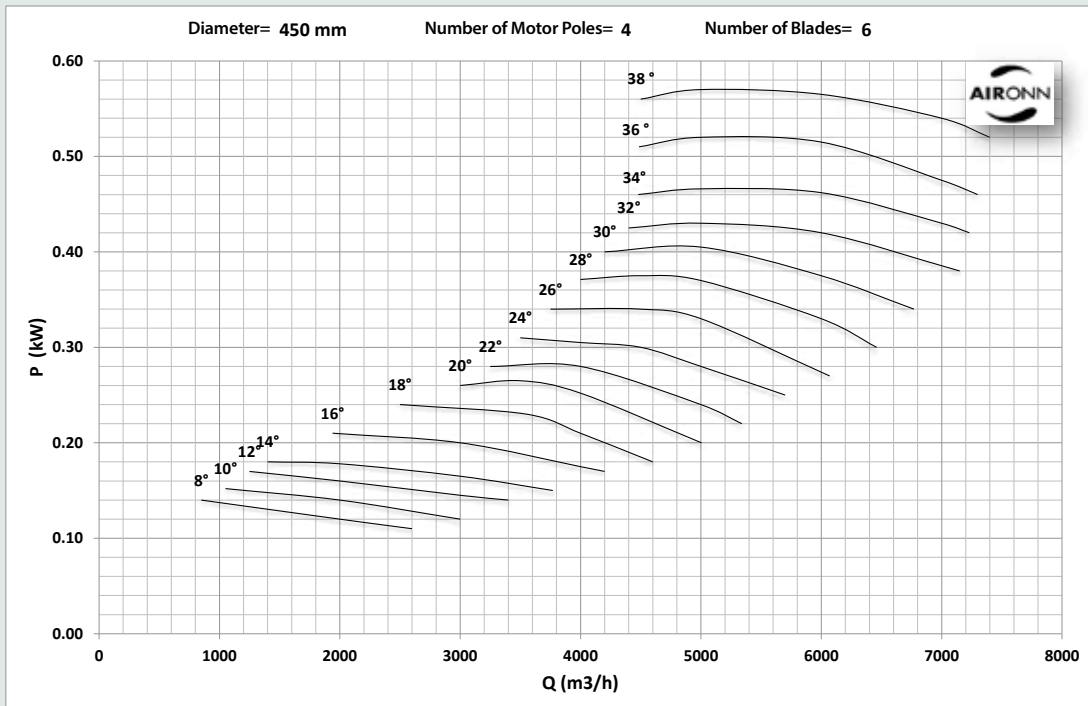
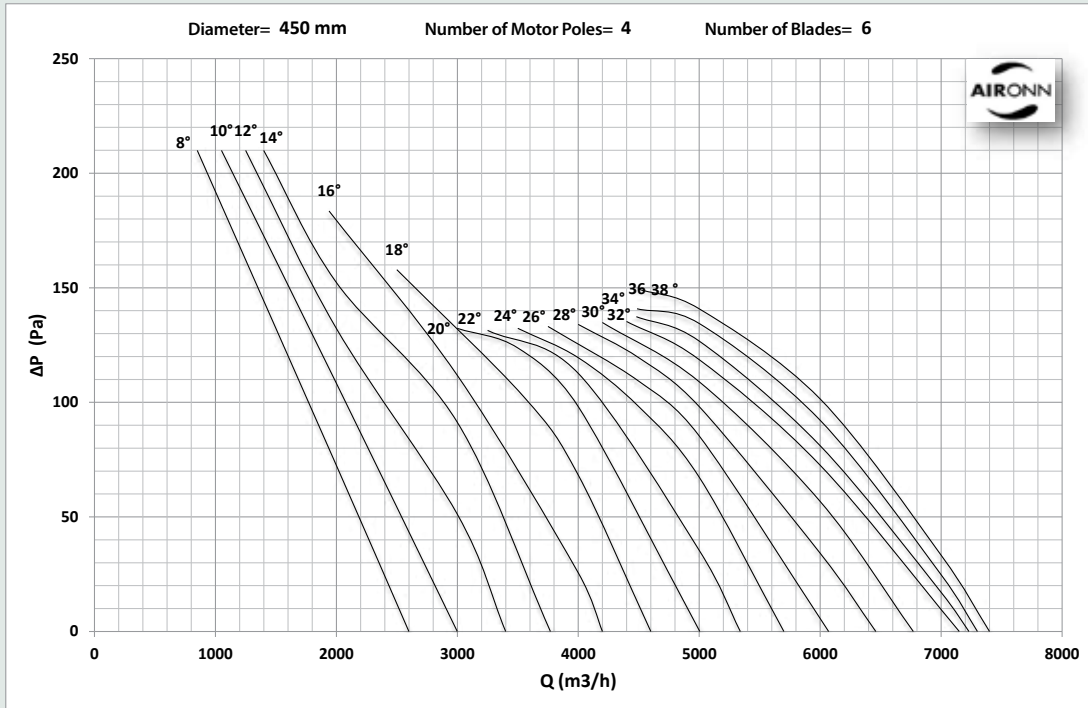

# Roof Type Axial (Horizontal) Smoke Exhaust Fan Series

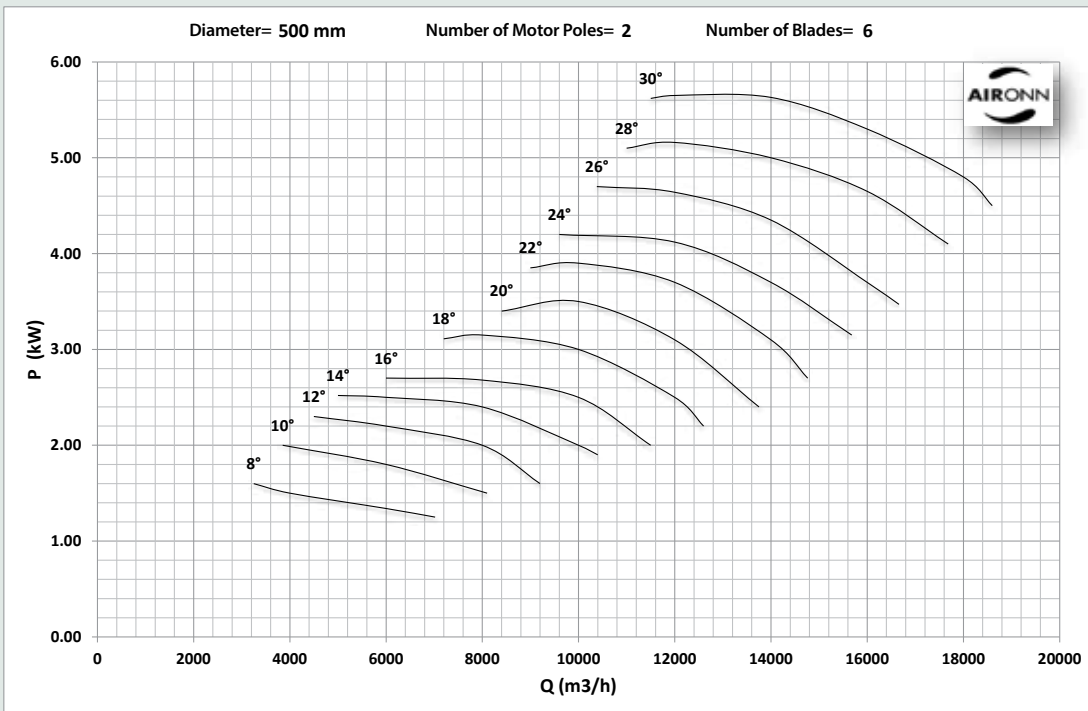
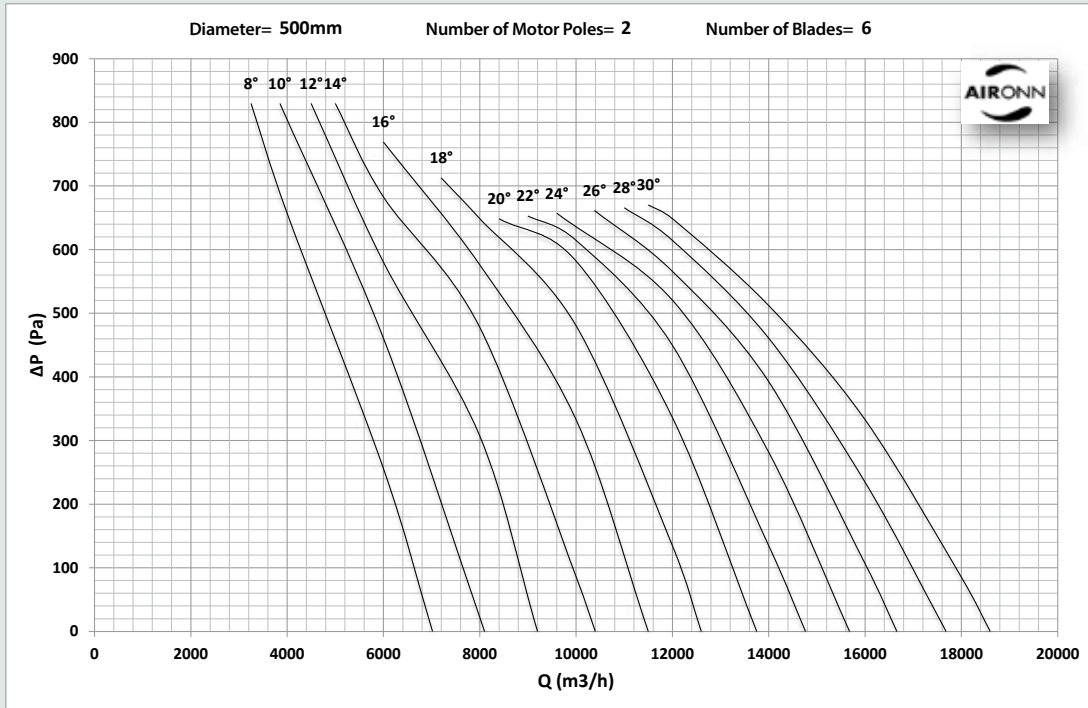

# Roof Type Axial (Horizontal) Smoke Exhaust Fan Series

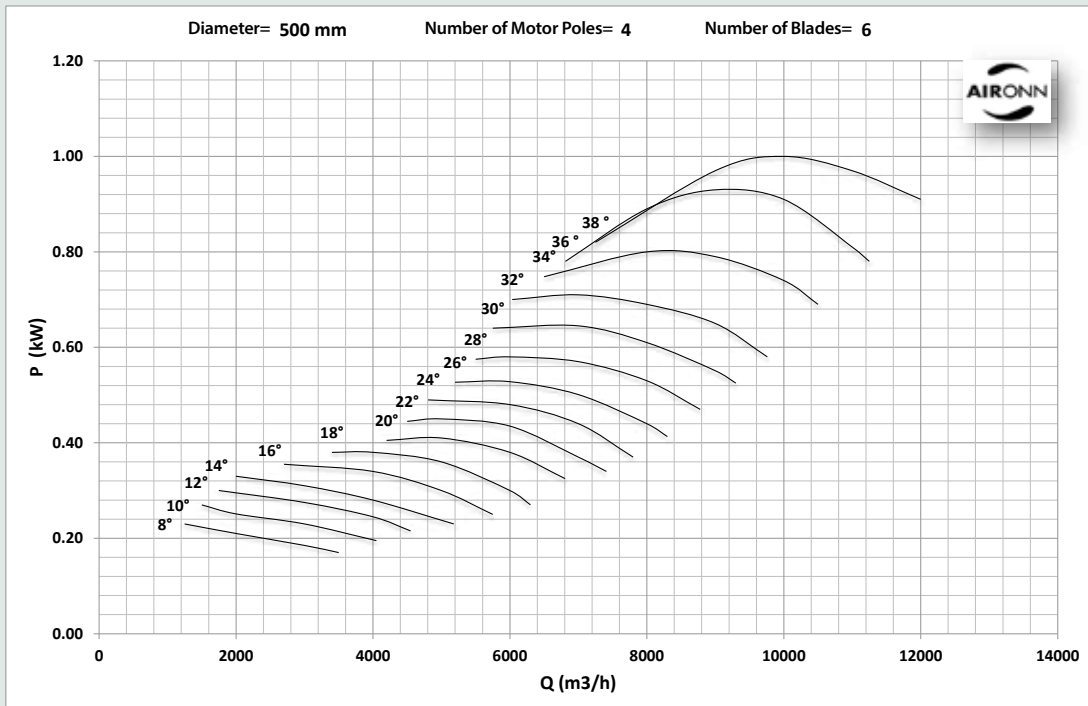
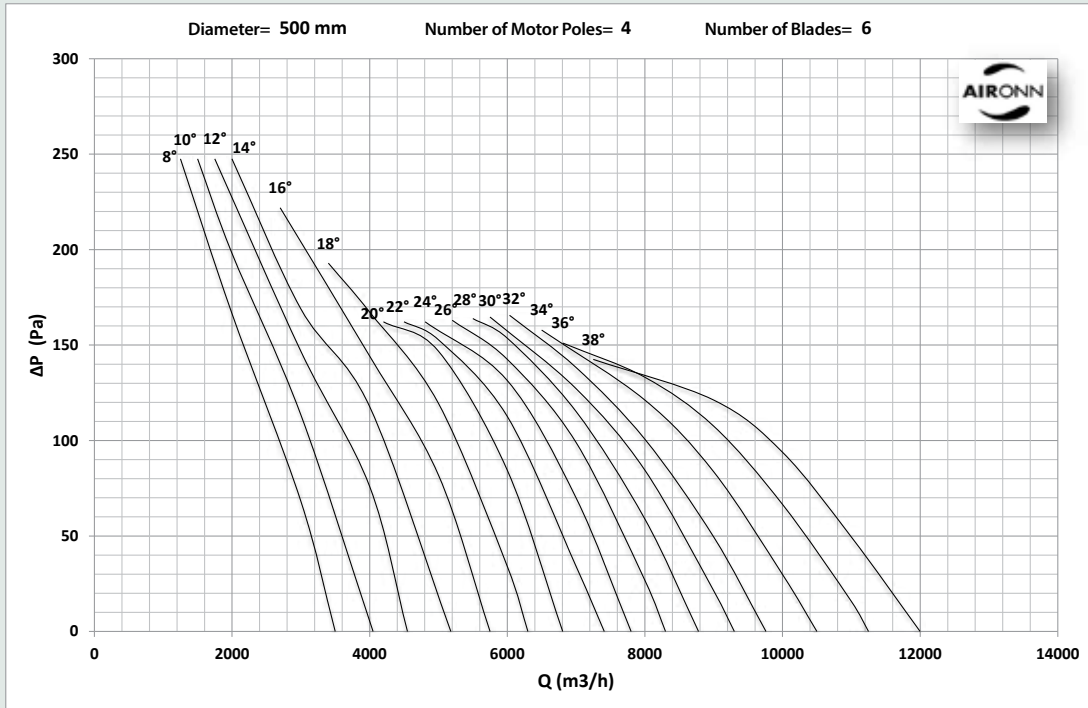

# Roof Type Axial (Horizontal) Smoke Exhaust Fan Series

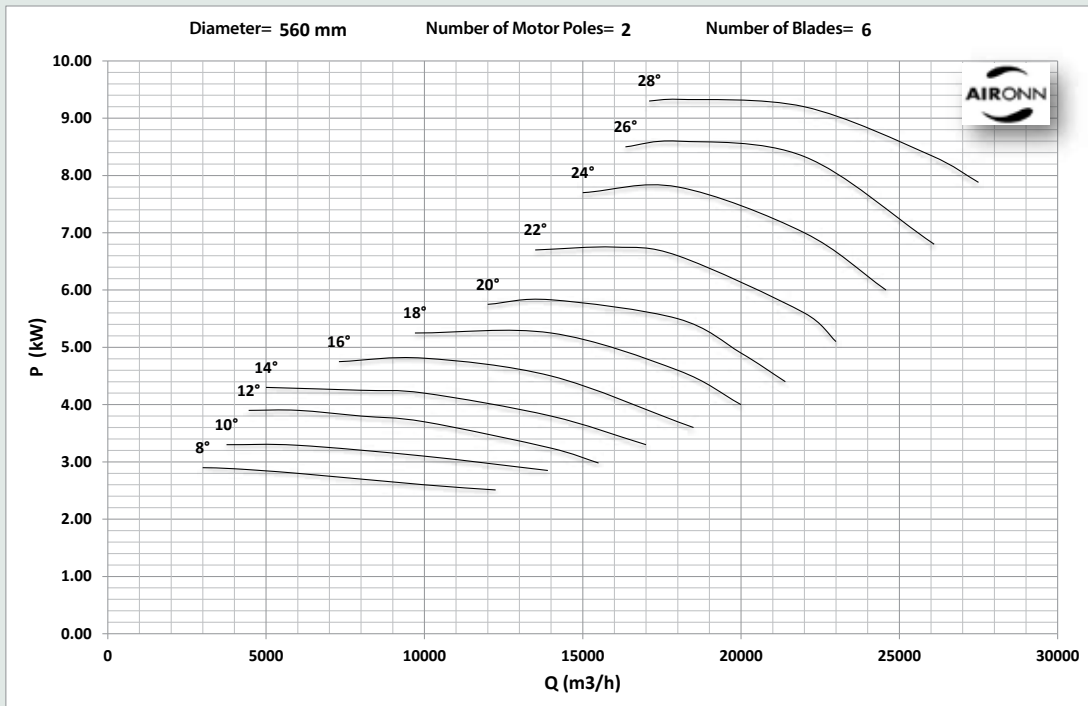
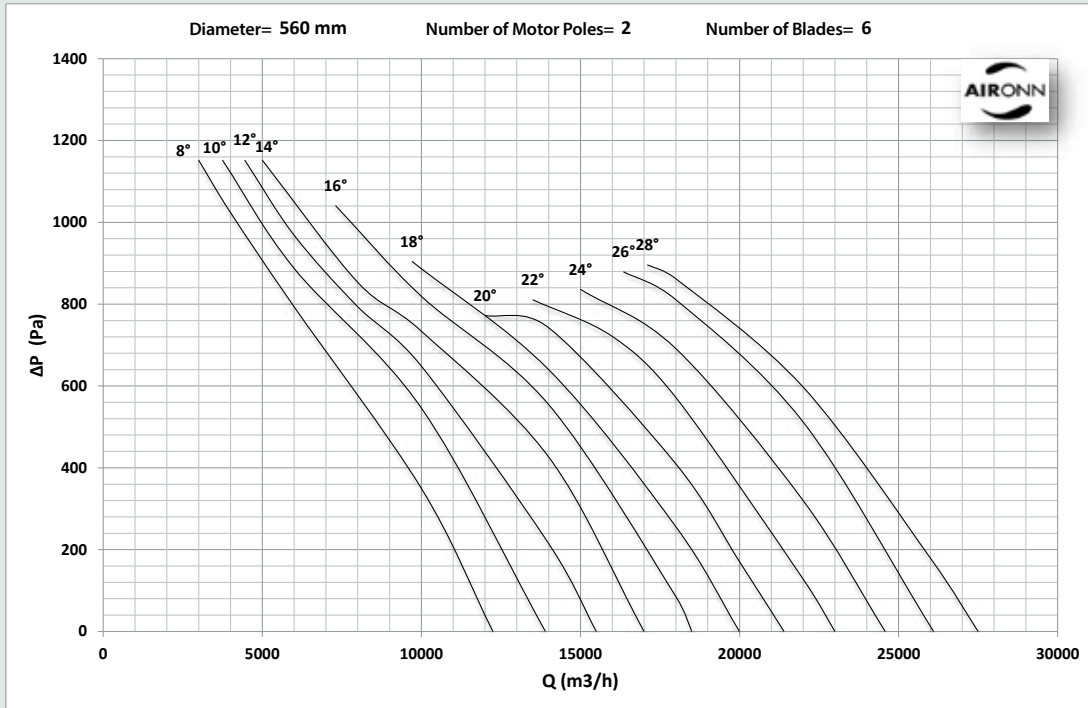

# Roof Type Axial (Horizontal) Smoke Exhaust Fan Series

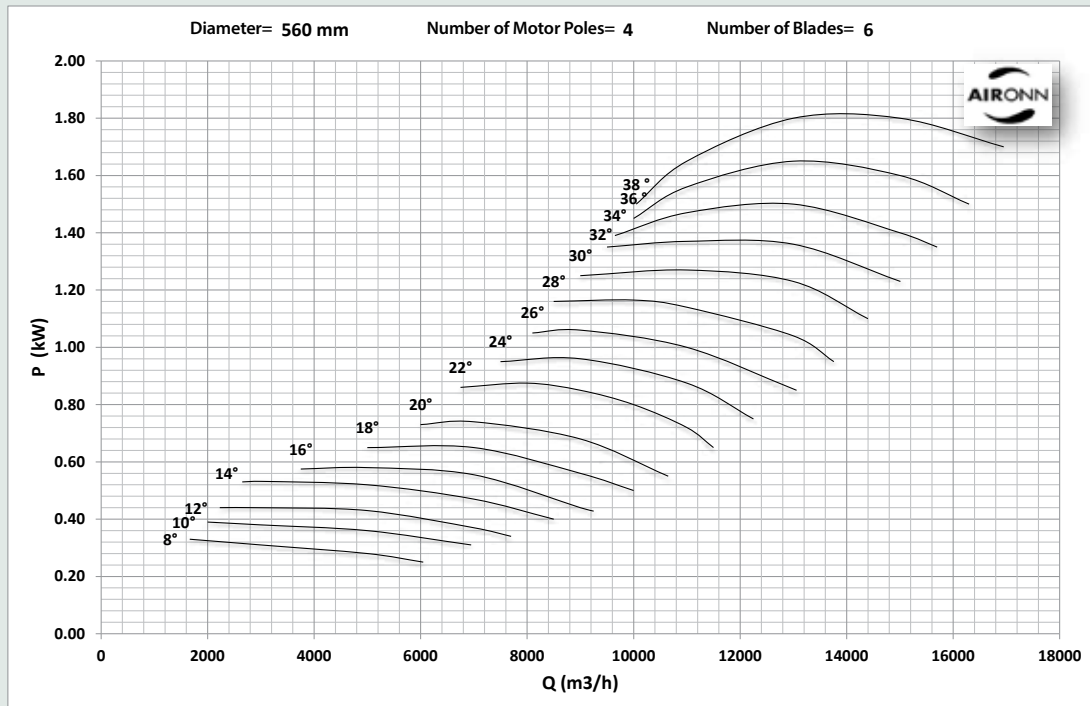
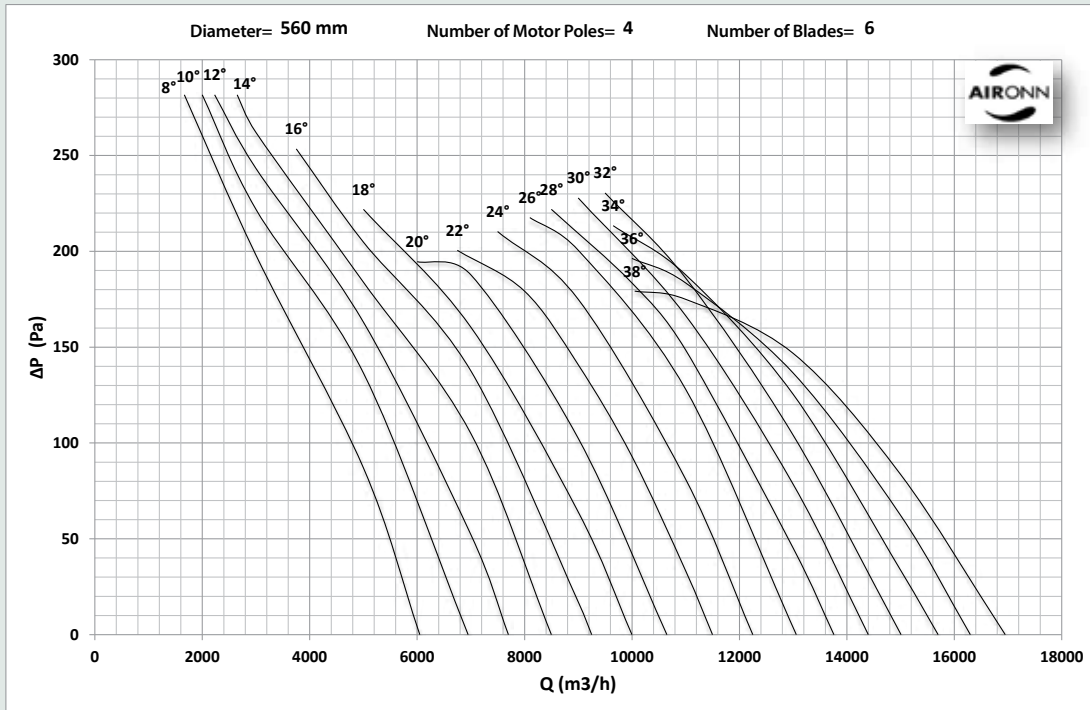



# Roof Type Axial (Horizontal) Smoke Exhaust Fan Series

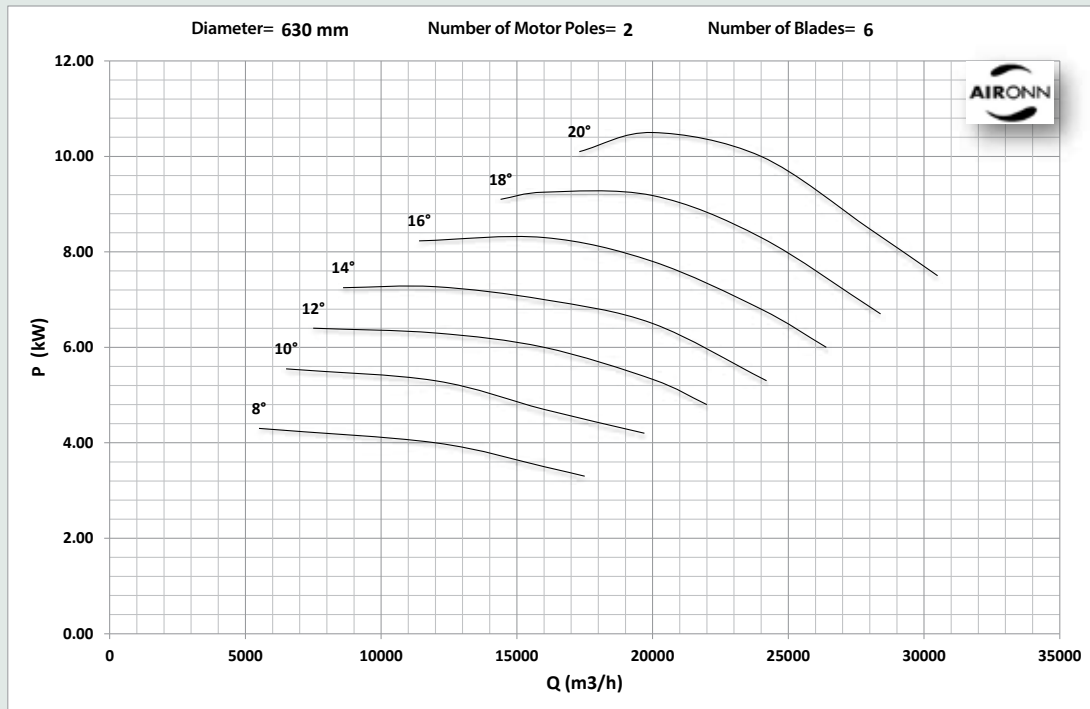
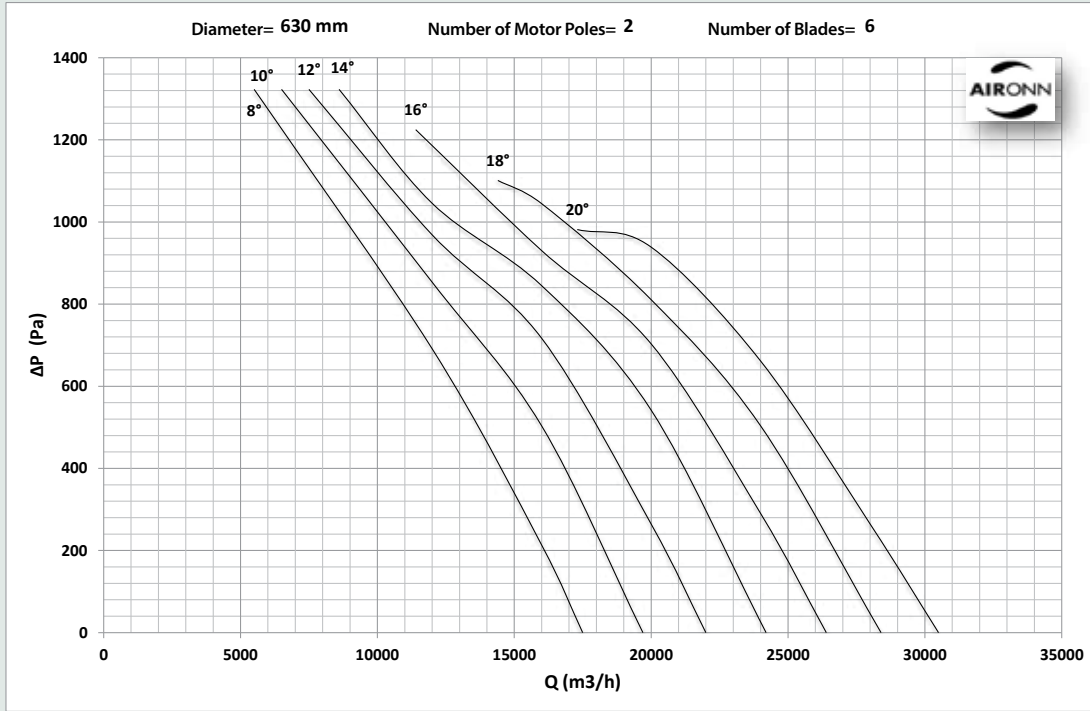

# Roof Type Axial (Horizontal) Smoke Exhaust Fan Series

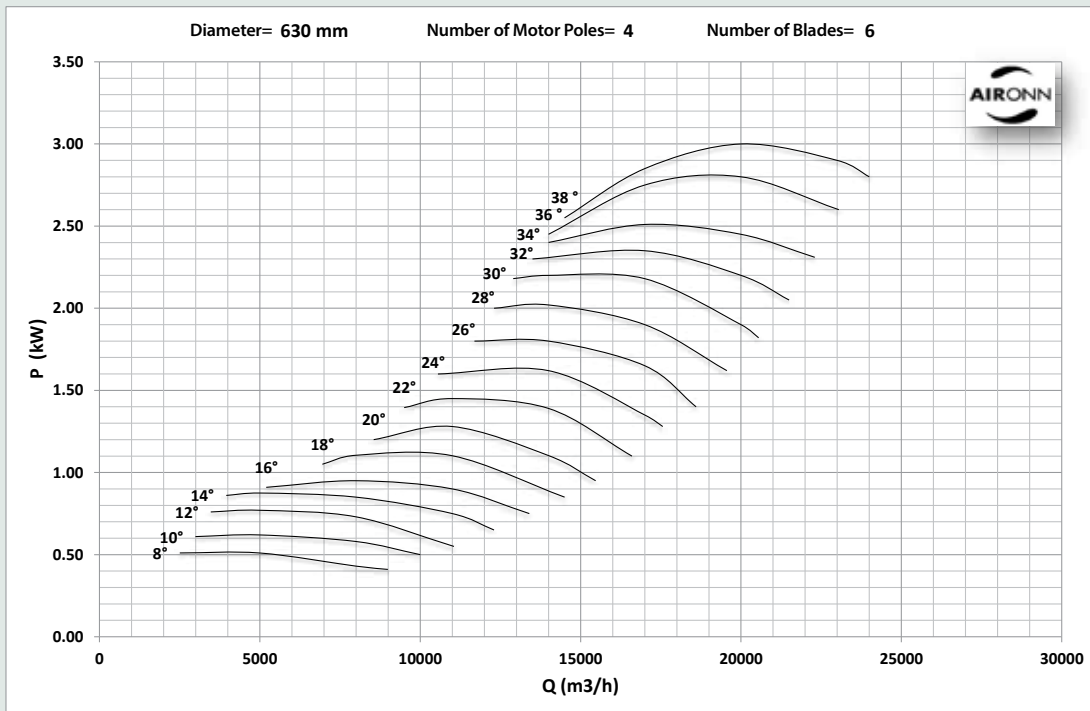
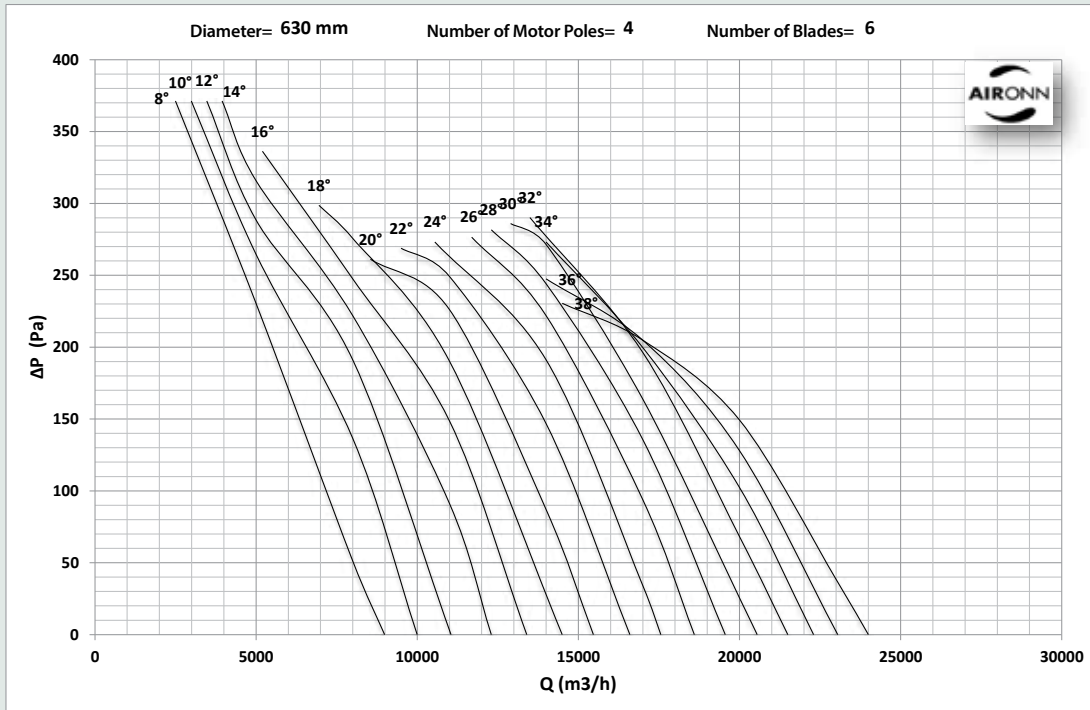

# Roof Type Axial (Horizontal) Smoke Exhaust Fan Series

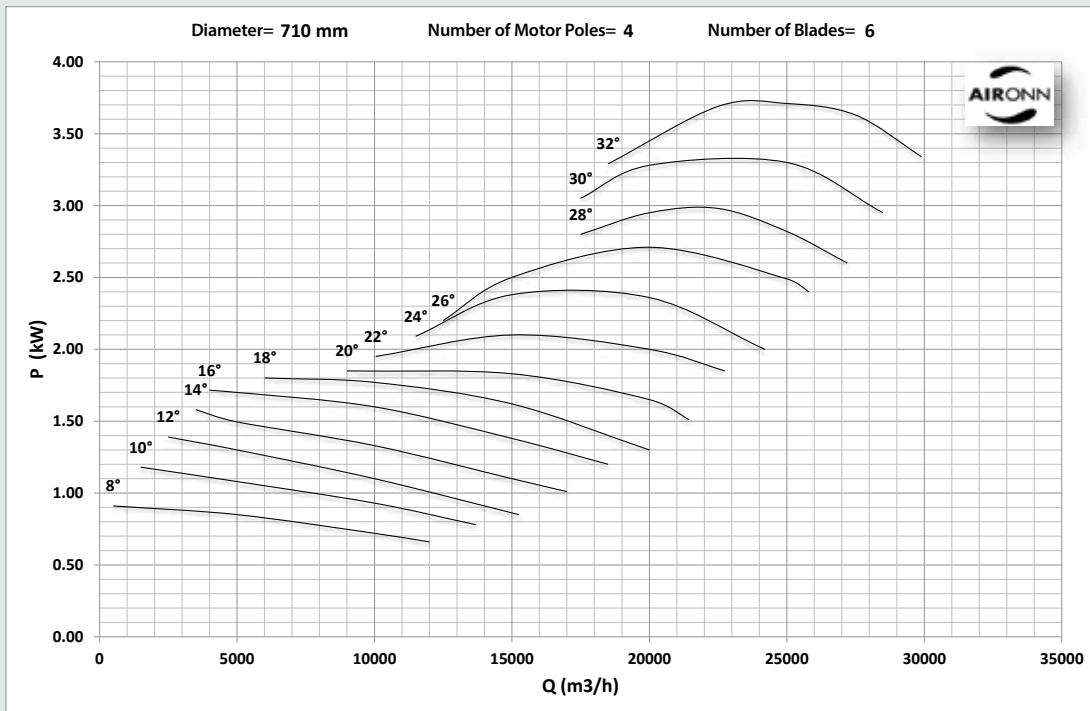
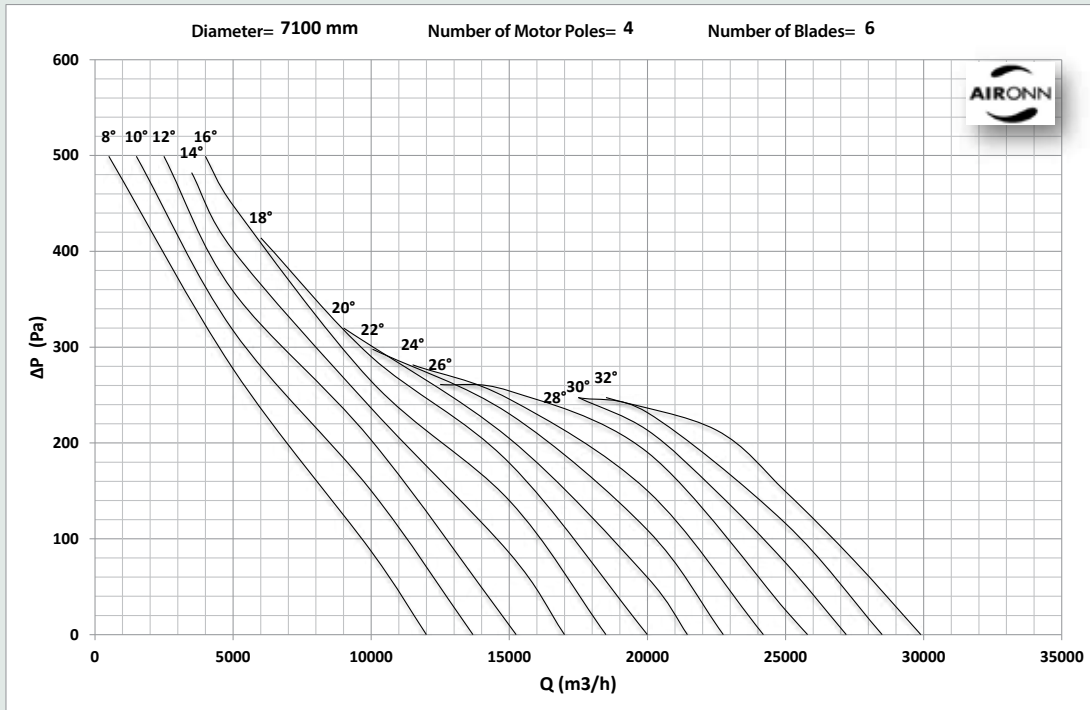

# Roof Type Axial (Horizontal) Smoke Exhaust Fan Series

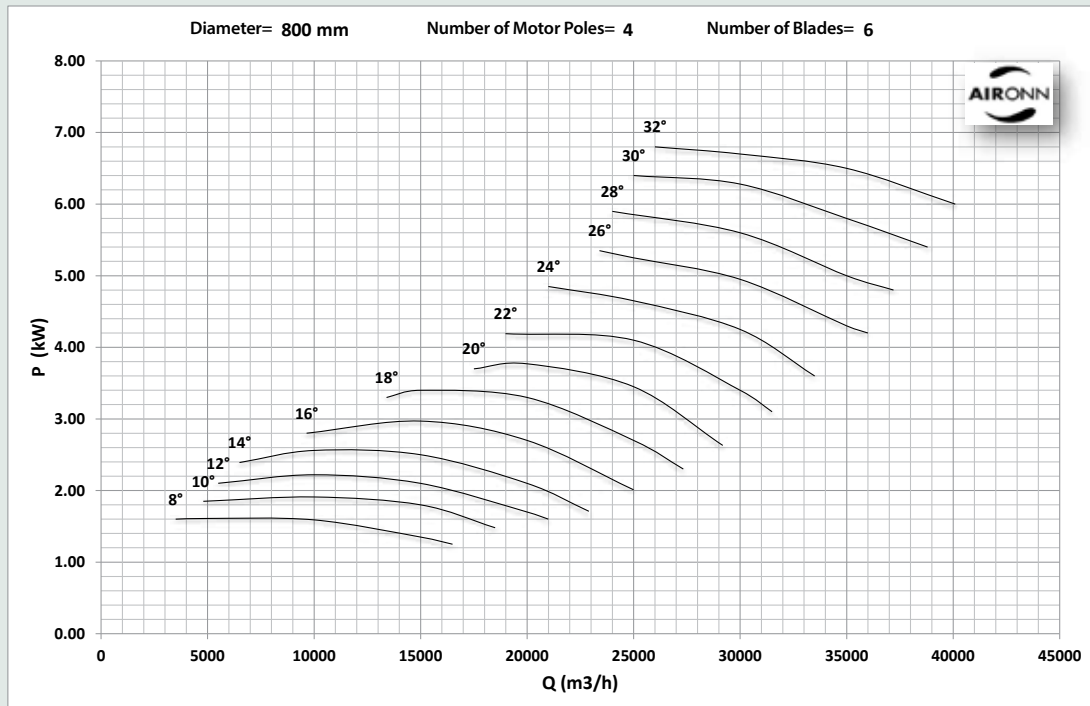
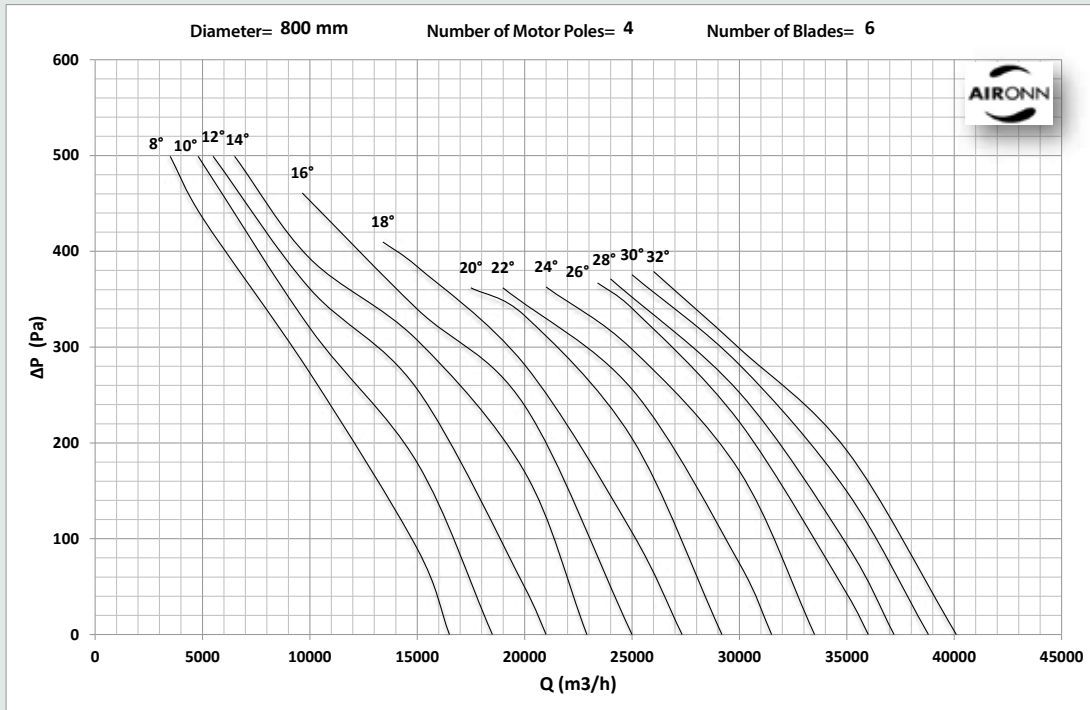

# Roof Type Axial (Horizontal) Smoke Exhaust Fan Series

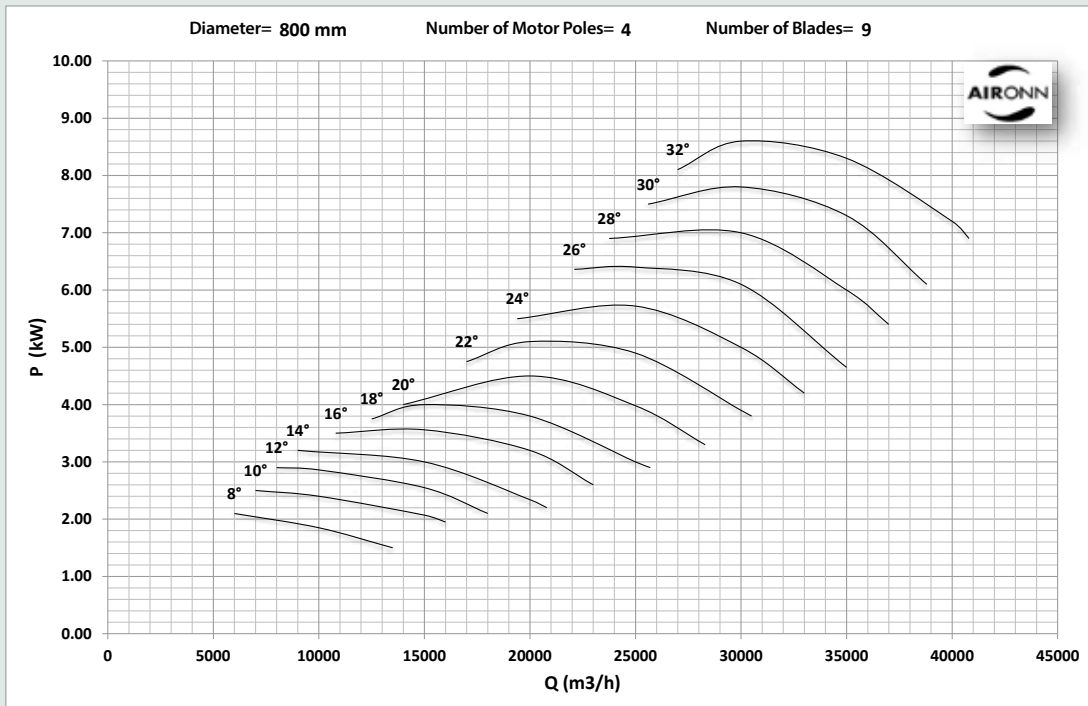
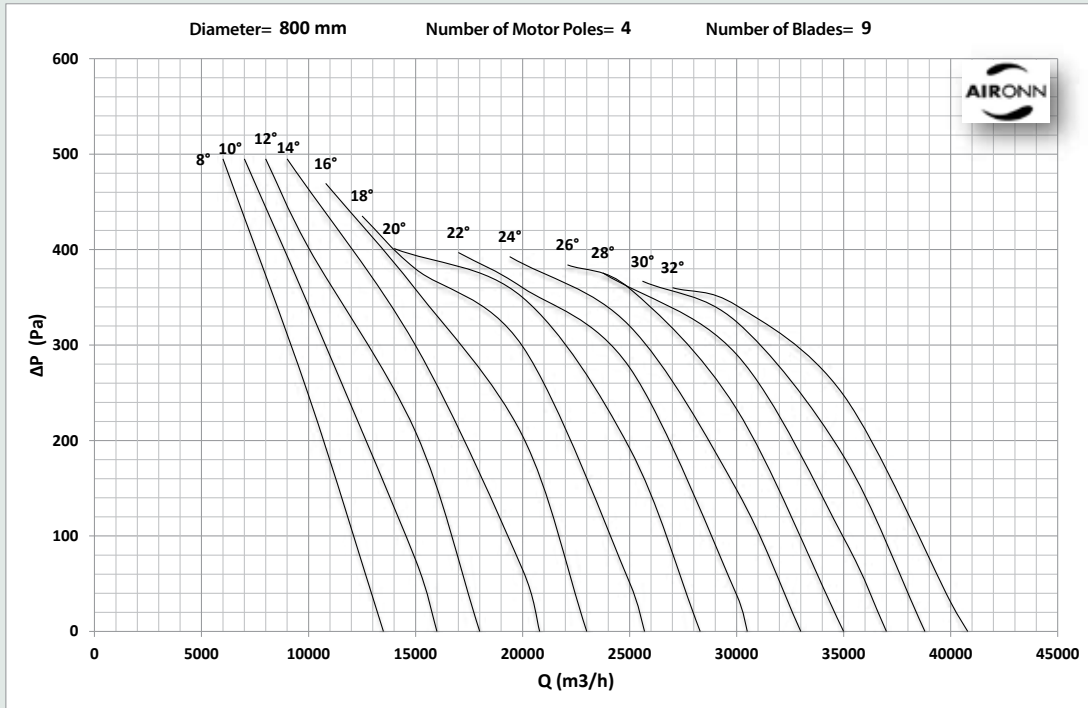

# Roof Type Axial (Horizontal) Smoke Exhaust Fan Series

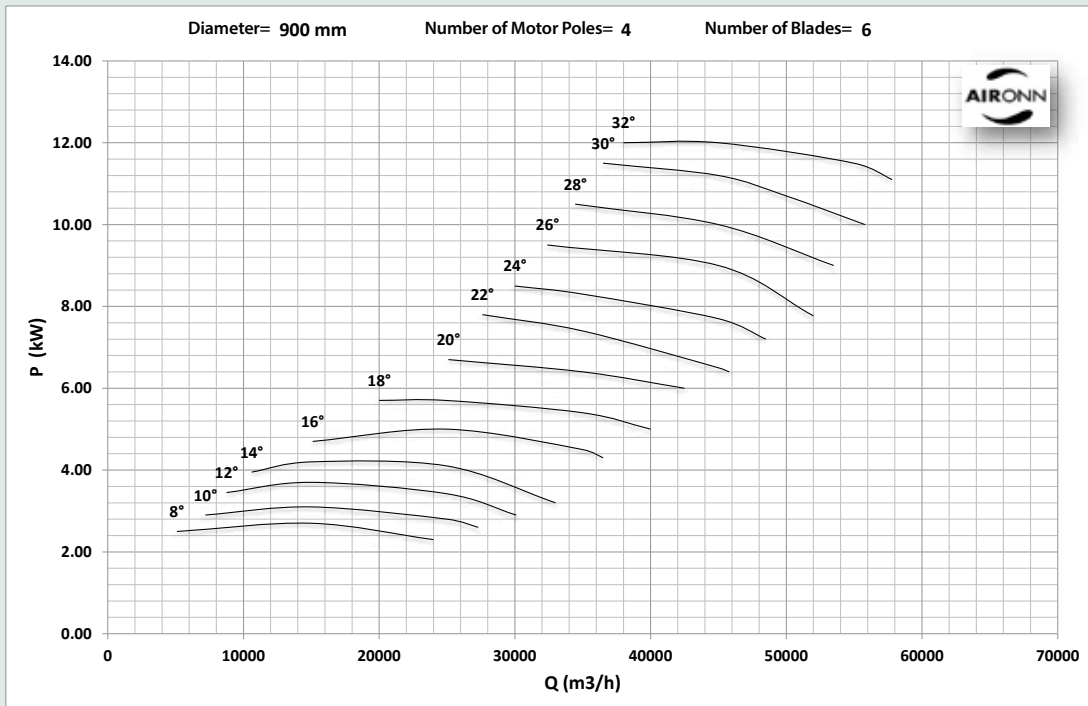
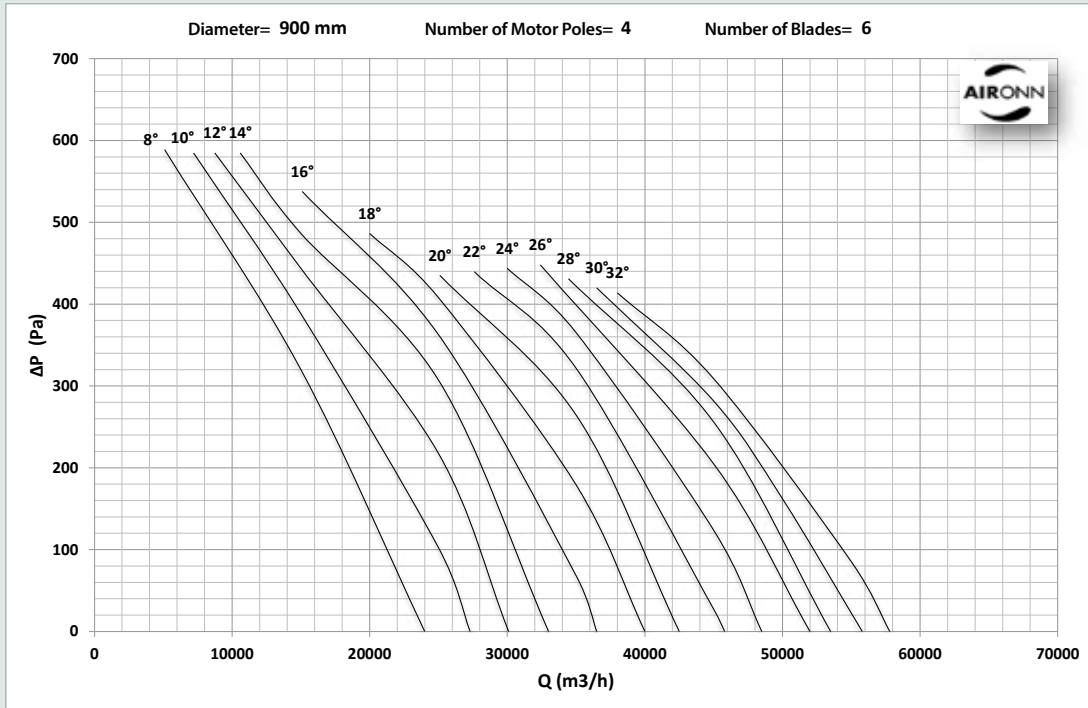

# Roof Type Axial (Horizontal) Smoke Exhaust Fan Series

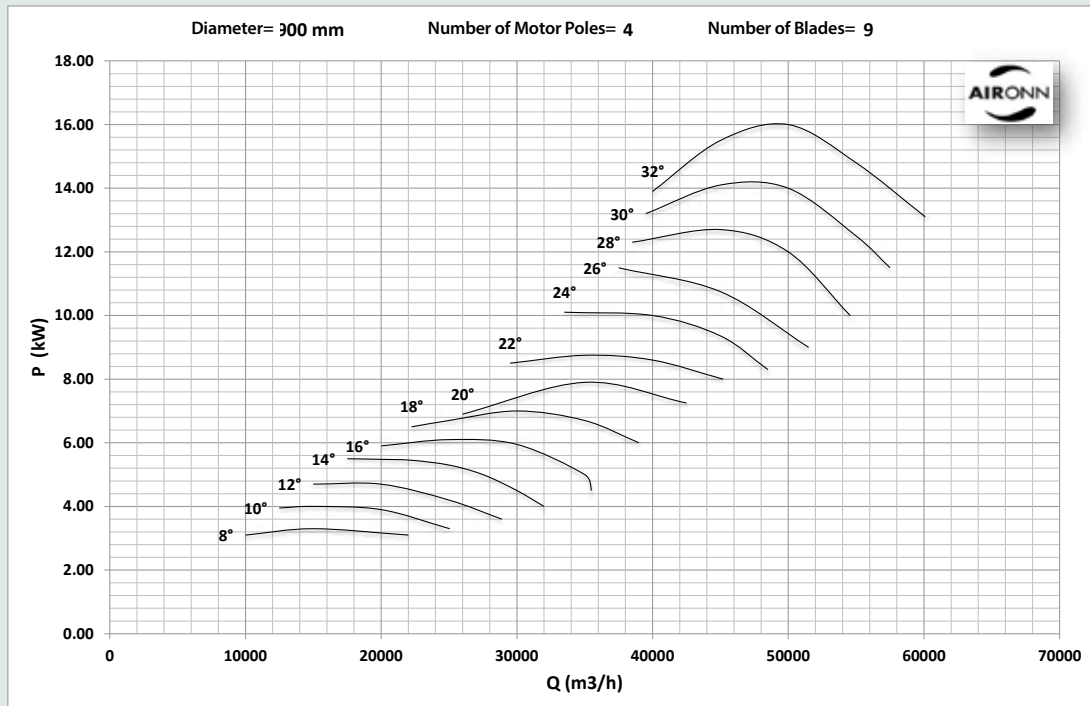
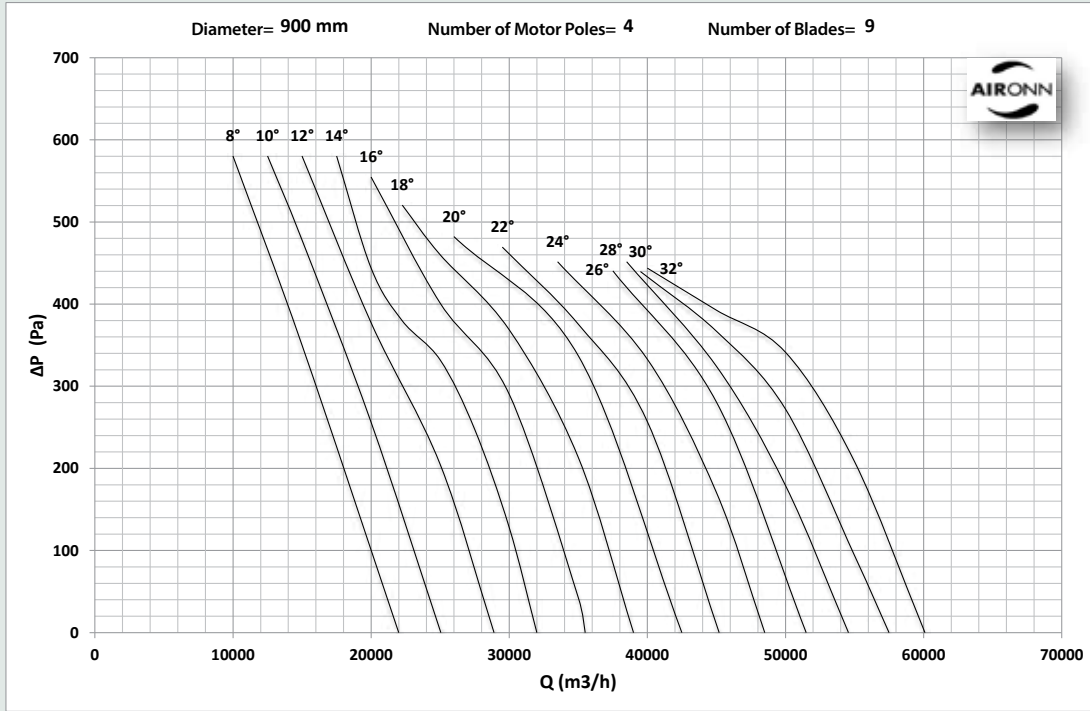

# Roof Type Axial (Horizontal) Smoke Exhaust Fan Series

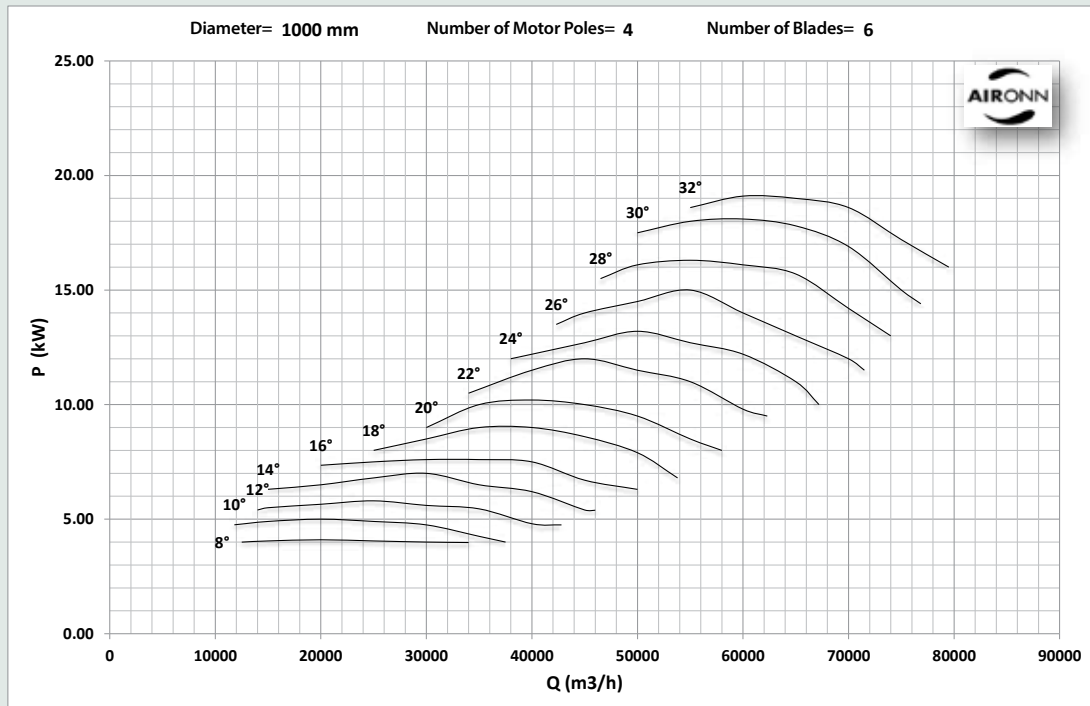
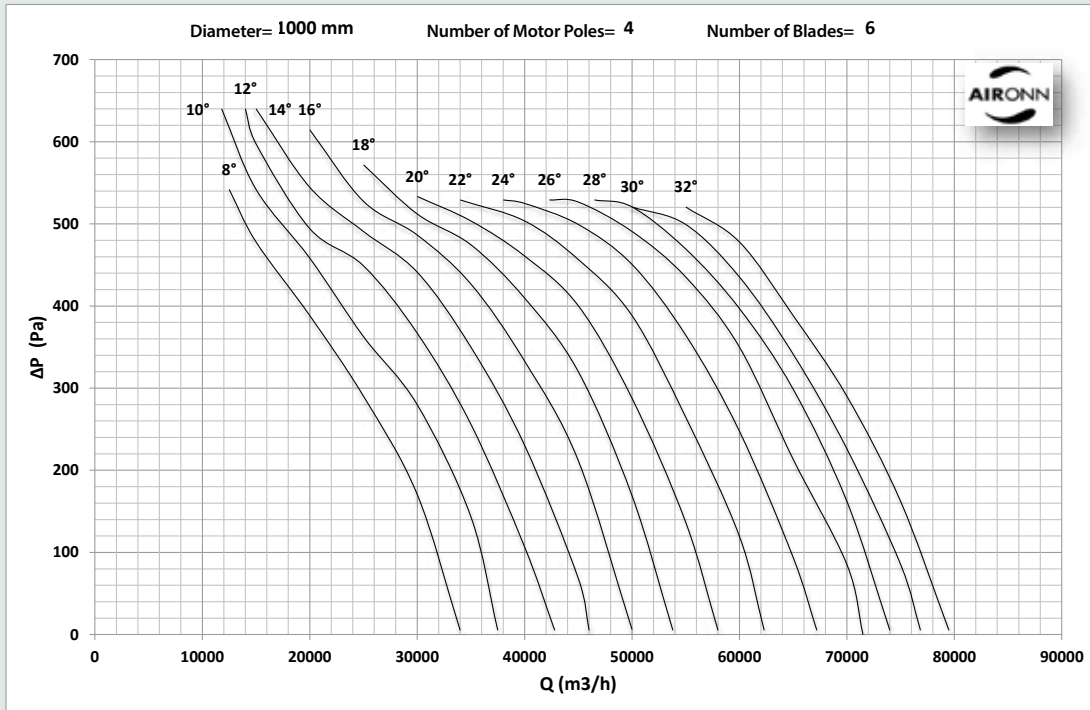



# Roof Type Axial (Horizontal) Smoke Exhaust Fan Series

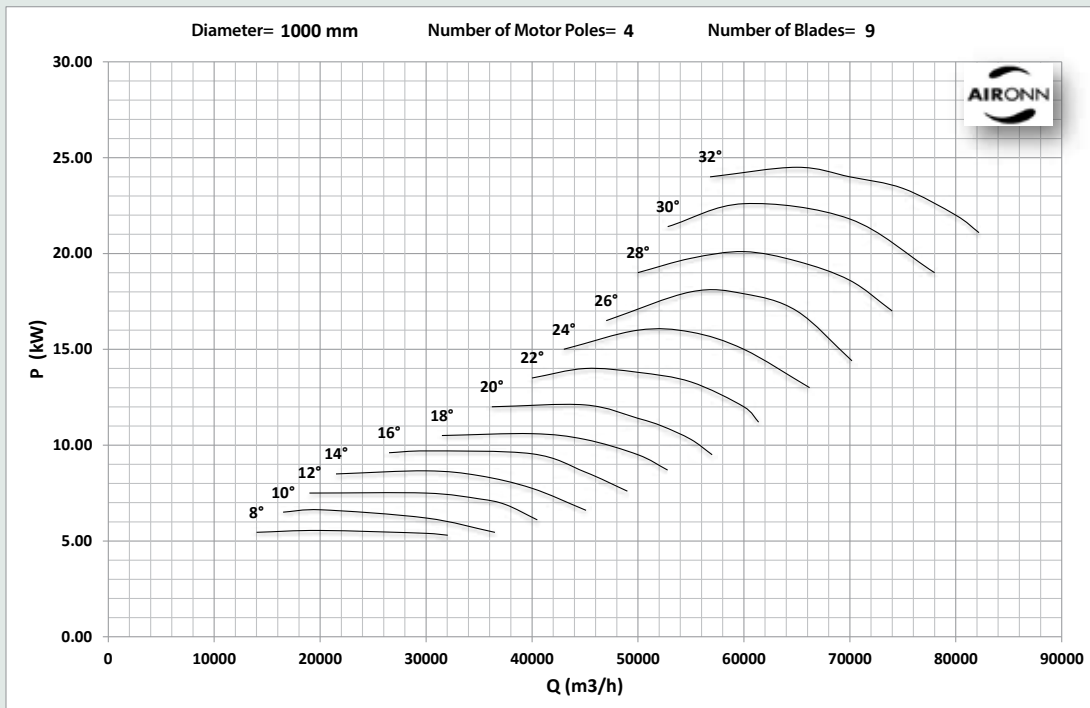
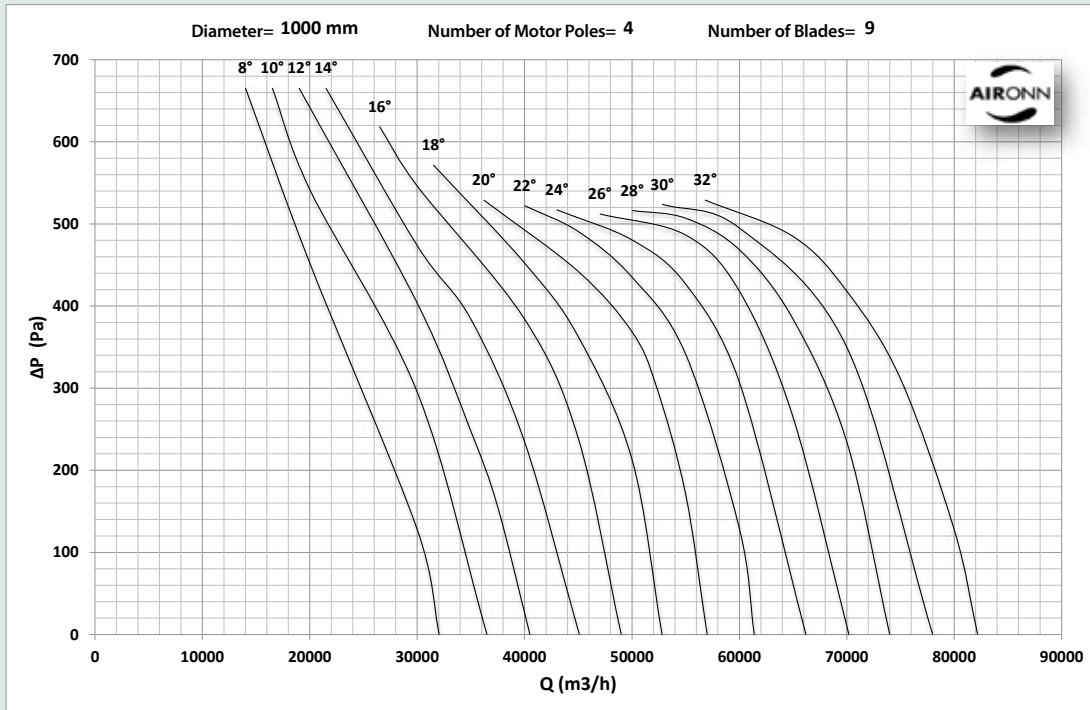

# Roof Type Axial (Horizontal) Smoke Exhaust Fan Series

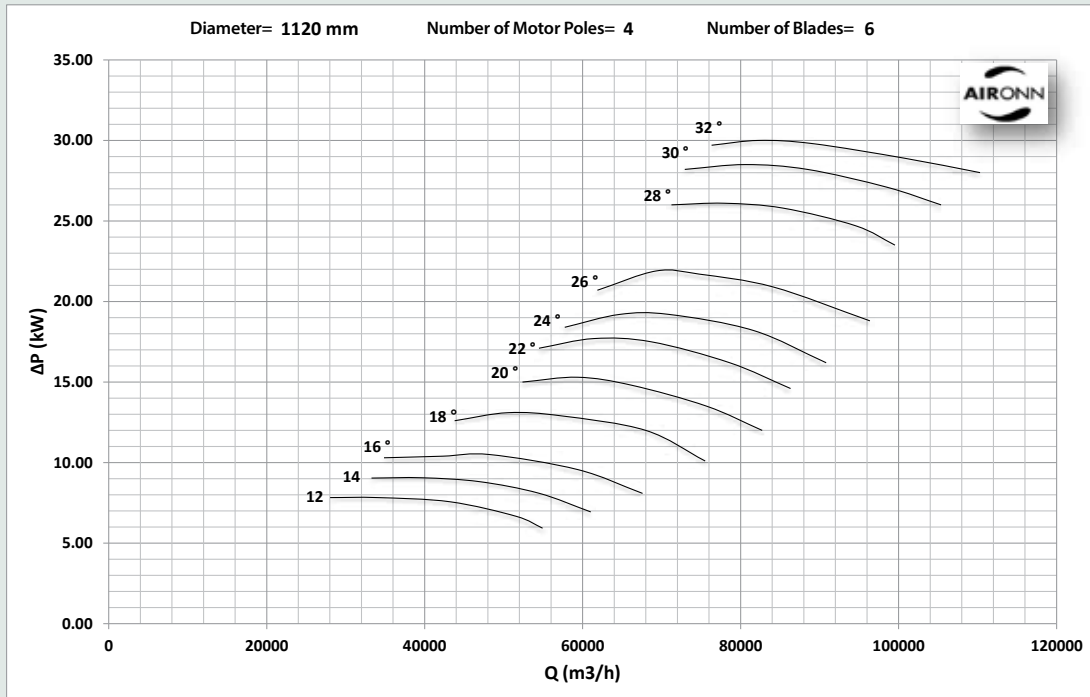
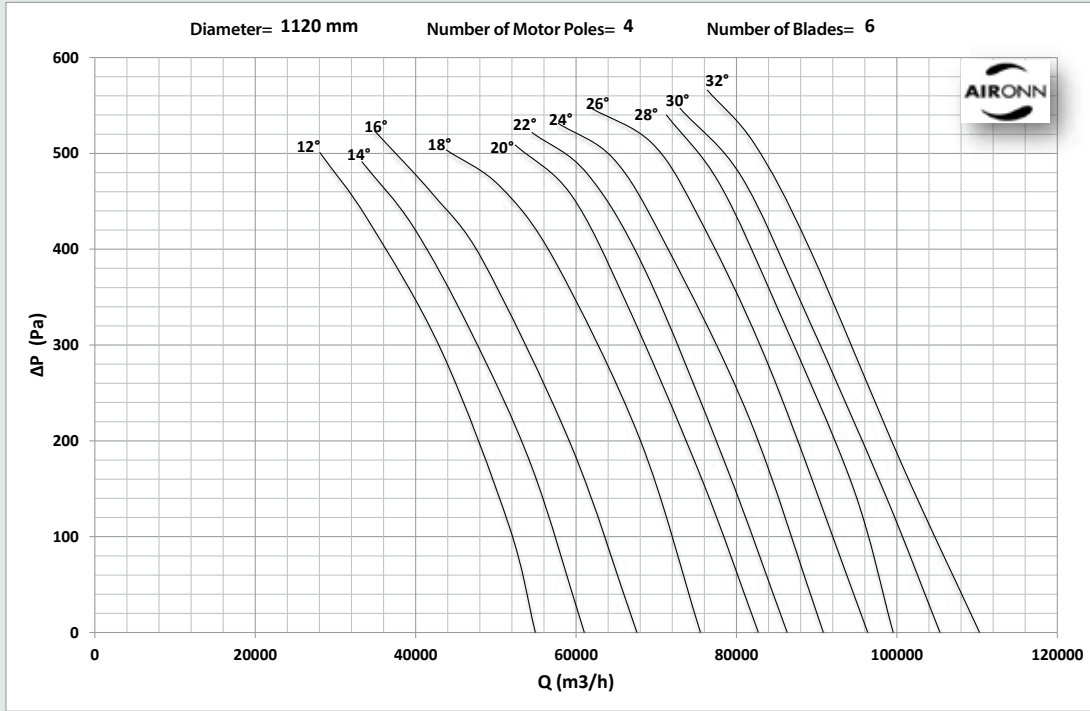

# Roof Type Axial (Horizontal) Smoke Exhaust Fan Series

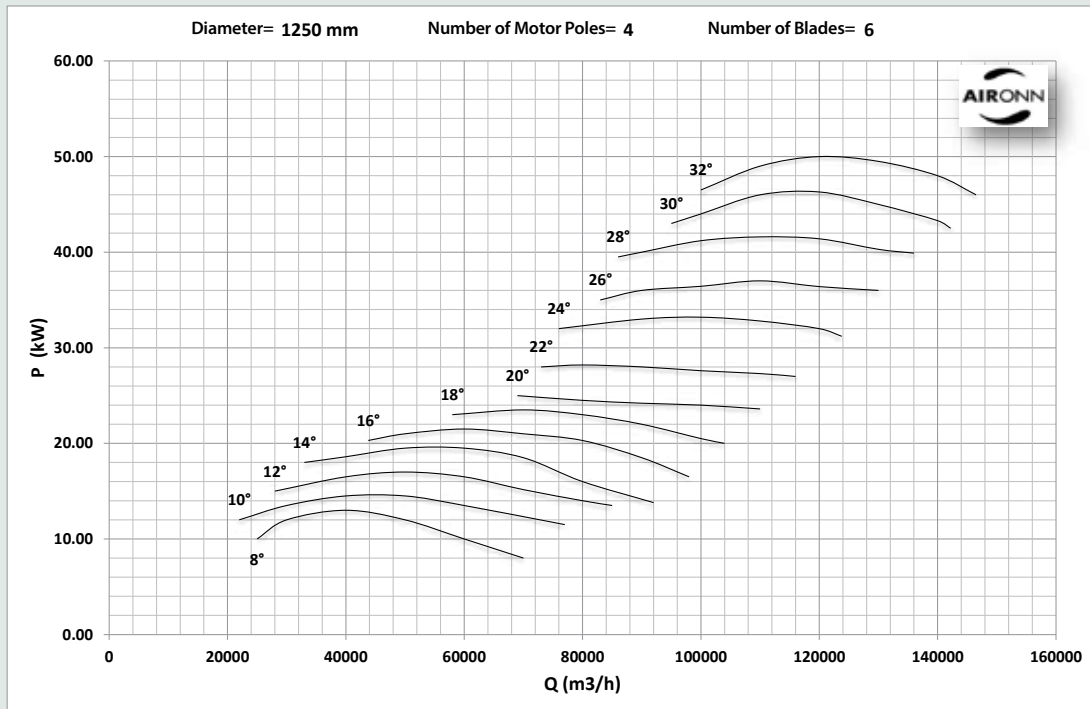
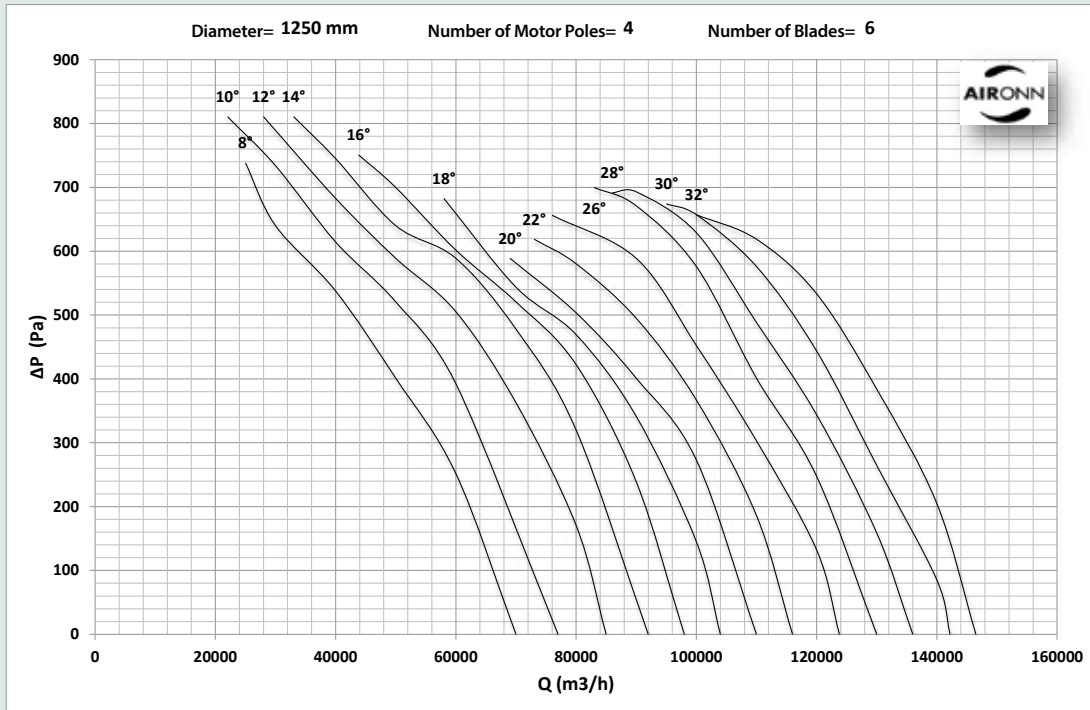

# Roof Type Axial (Horizontal) Smoke Exhaust Fan Series

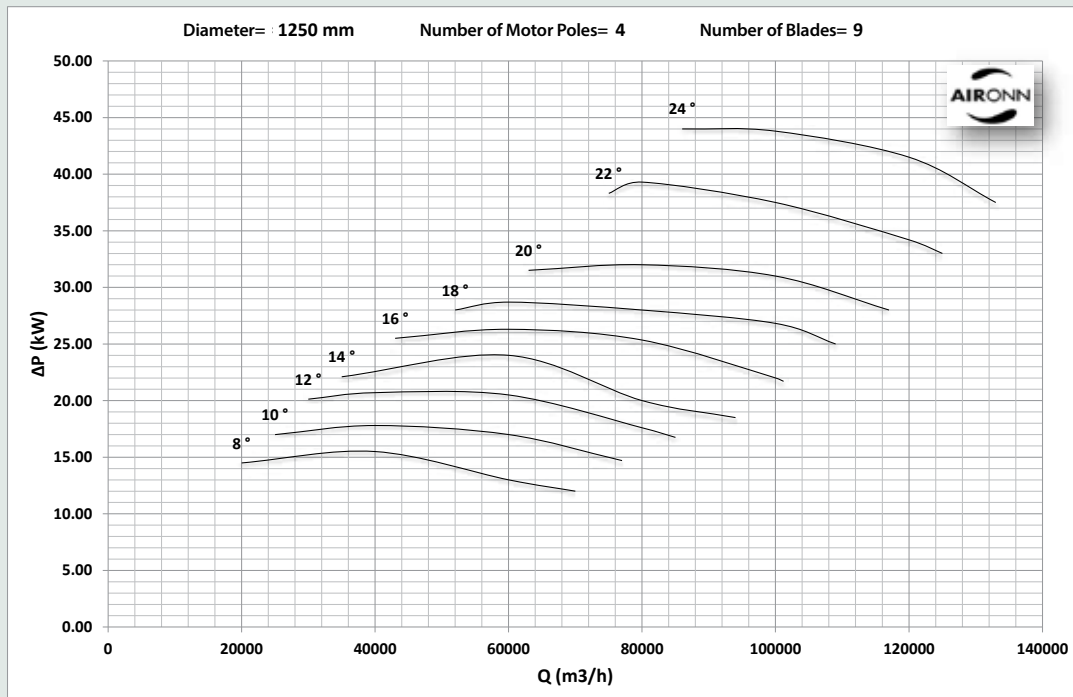
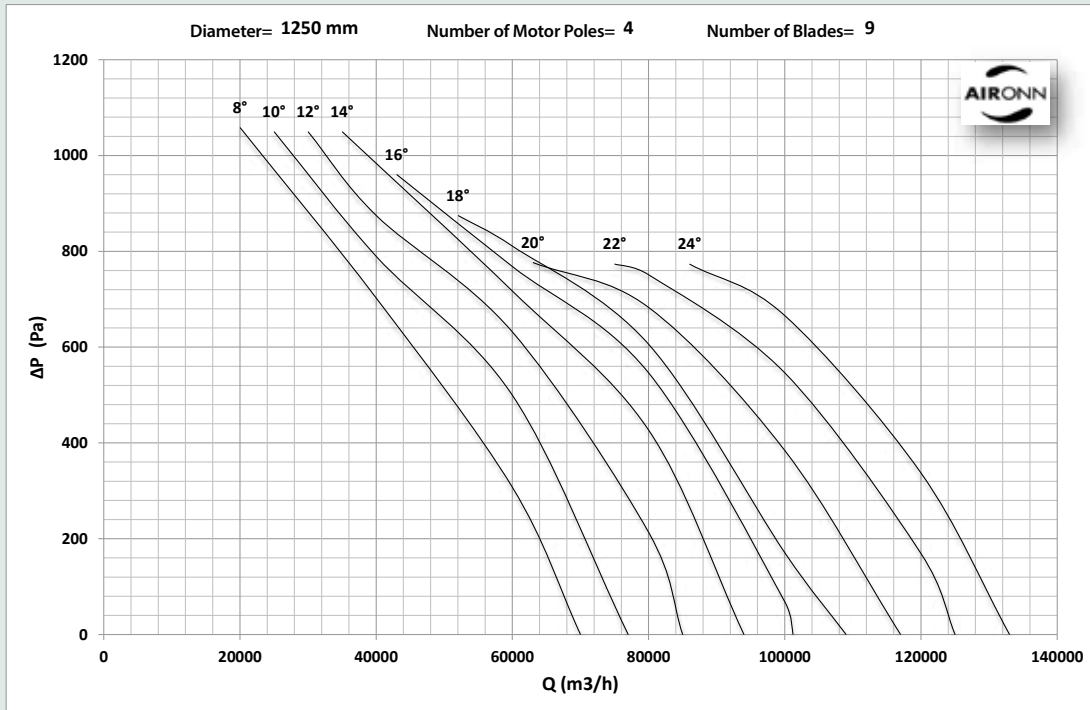



# Roof Type Axial (Vertical) Smoke Exhaust Fan Series

Fans in the Aironn Roof Type Axial Smoke Exhaust Fan series have 300 ° C-2 hours and 400 ° C-2 hours certificates in compliance with EN 12101-3. Adjustable edge angle of the series in the range of diameters between 400 mm and 1250 mm presents a broad performance range. It also provides an advantage by precisely ensuring the required flow. Performance of the fans in Roof Type Axial Smoke Exhaust Fan Series have been tested in accordance with AMCA 210-07 standard.

## Fan Body

The body of the fans is made of high quality and corrosion resistant hot-dip galvanize coated sheet metal. The fan flanges are manufactured by bending the body so they are self flanged. All models have horizontal and vertical air throw options. Body inspection hatch is optional.

## Fan Blades

Aerodynamic fan blades are made of ETIAL 171 with injection moulding method. They are statically and dynamically balanced in compliance with ISO 1940/1-2003.

## Motor

IP 55 motors with class H insulation are available in single cycle or double cycle options. If requested, single cycle motors can be used with inverters.

## Electricity

IP 55 electric terminal box made of aluminium is standard.

## Accessories

Back Draft Damper, Counter Flange, Protection Grill, Flexible Coupling, Pacco (Package) Switch, Vibration Sensor, Inverter

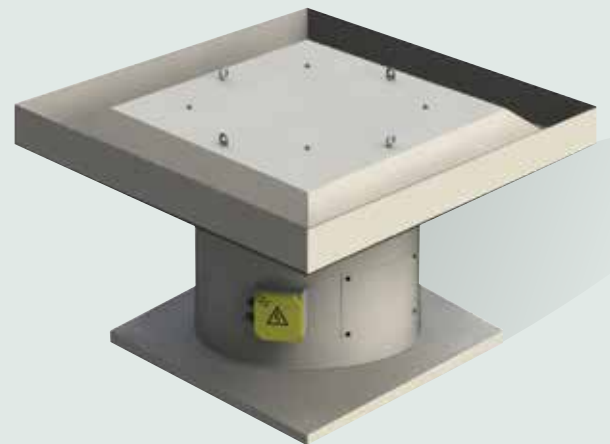

# Roof Type Axial (Vertical) Fresh Air Fan Series

Fans in Aironn Roof Type Fresh Air Fan Series are suitable to operate at maximum 55 °C. Adjustable edge angle of the series in the range of diameters between 400 mm and 1250 mm presents a broad performance range. It also provides an advantage by precisely ensuring the required flow. Performance of the fans in Roof Type Axial Fresh Air Fan series have been tested in accordance with AMCA 210-07 standard.

## Fan Body

The body of the fans is made of high quality and corrosion resistant hot-dip galvanize coated sheet metal. The fan flanges are manufactured by bending the body so they are self flanged. All models have horizontal and vertical air throw options. Body inspection hatch is optional.

## Fan Blades

Aerodynamic fan blades are made of ETIAL 171 with injection moulding method. They are statically and dynamically balanced in compliance with ISO 1940/1-2003.

## Motor

IP 55 motors with class F insulation are available in single cycle or double cycle options. If requested, single cycle motors can be used with inverters.

## Electricity

IP 55 electric terminal box made of plastic is standard.

## Accessories

Back Draft Damper, Counter Flange, Protection Grill, Flexible Coupling, Pacco (Package) Switch, Vibration Sensor, Inverter

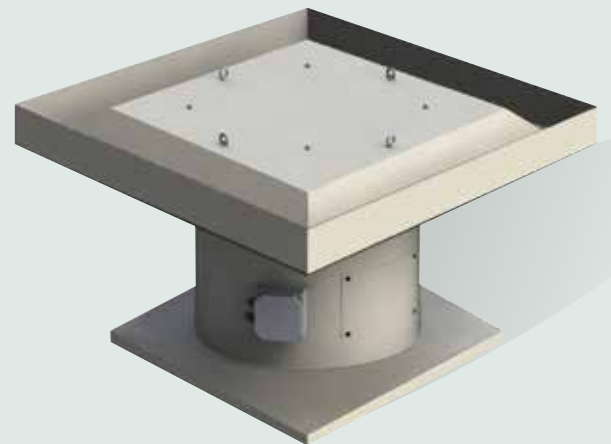

# Roof Type Axial (Vertical) Smoke Exhaust & Fresh Air Fan Series

## Dimensions

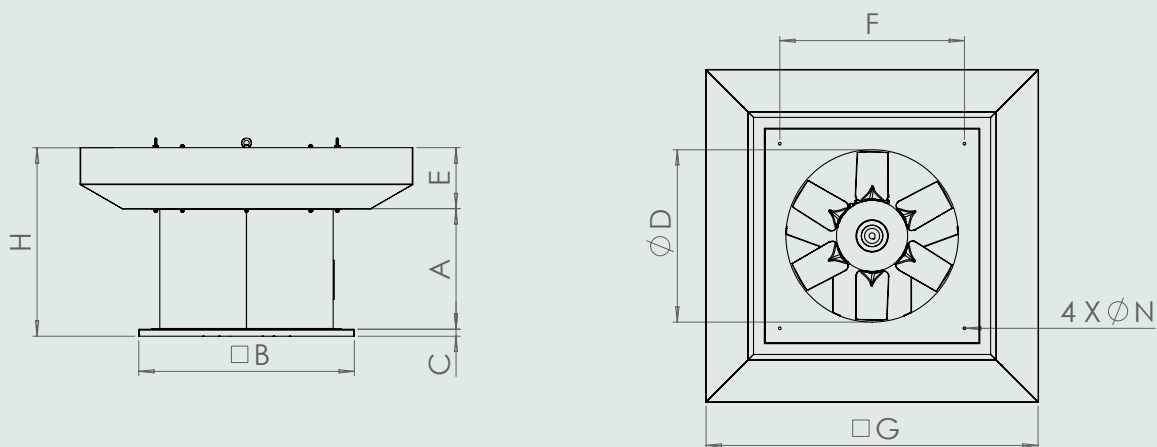

	A	B	C	D	E	F	G	H	Ø N
400	420	575	30	400	207	525	700	660	11
450	420	630	30	450	208	580	852	660	11
500	420	695	30	500	182	645	902	660	11
560	420	745	30	560	210	695	1050	660	11
630	470	815	30	630	225	765	1210	725	11
710	500	895	30	710	250	845	1380	790	11
800	580	995	30	800	282	945	1540	895	13
900	700	1090	30	900	342	1040	1605	1075	13
1000	775	1190	30	1000	377	1140	1875	1185	13
1250	775	1145	30	1250	380	1095	2140	1185	13



## Roof Type Axial (Vertical) Fresh Air Fan Series

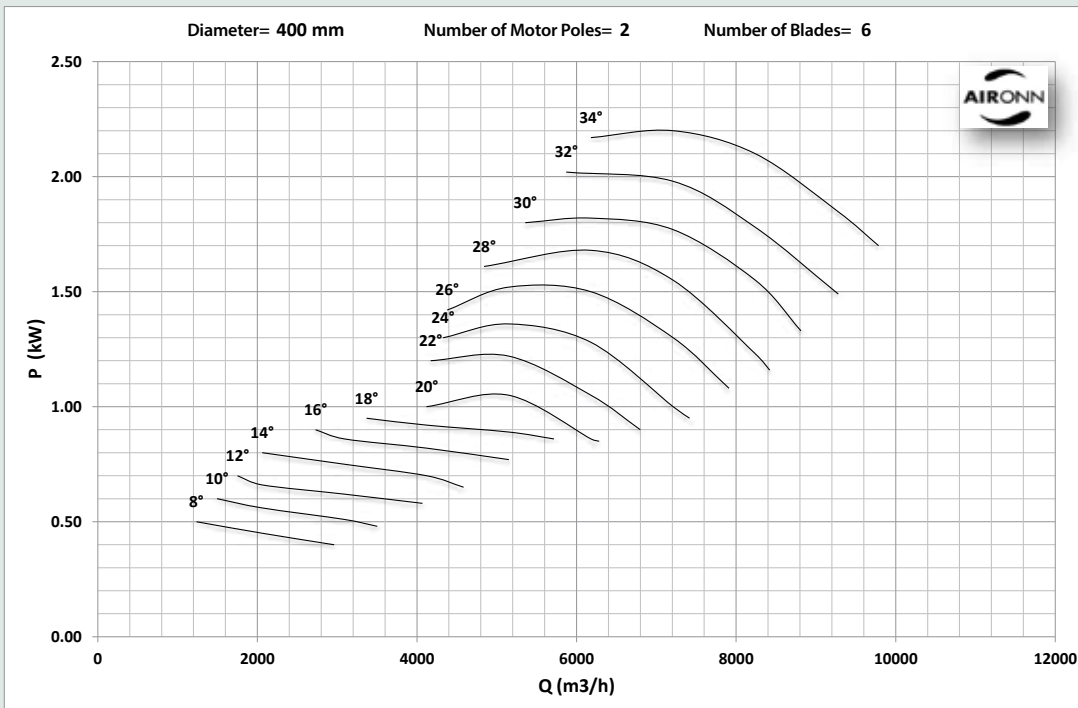
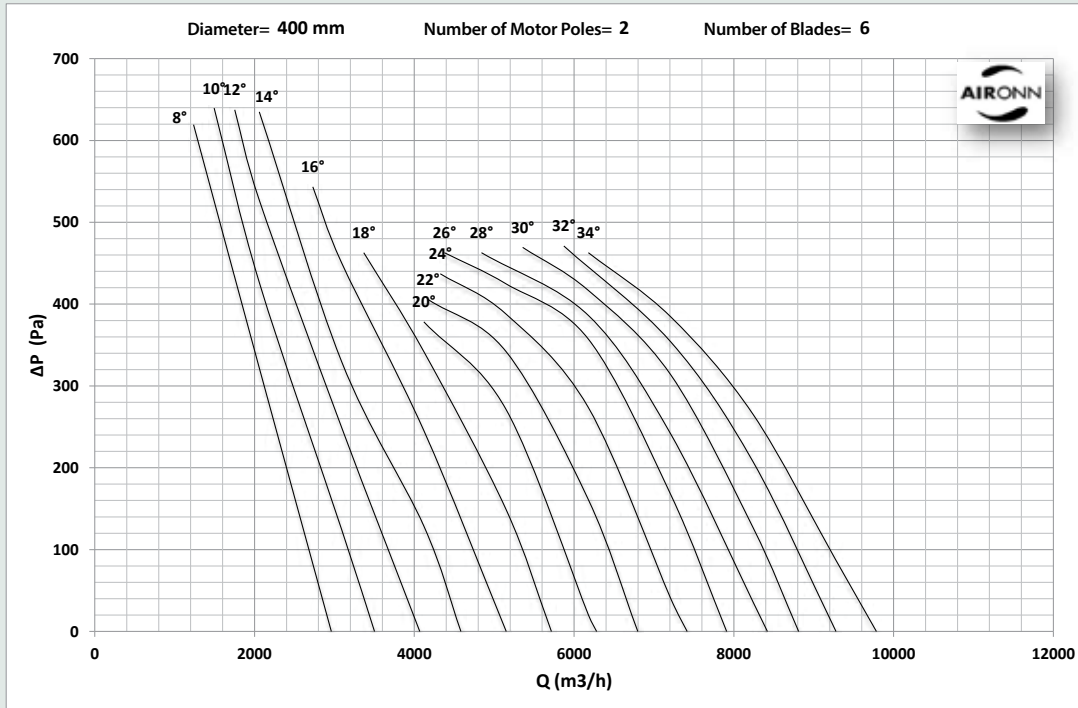

## Roof Type Axial (Vertical) Fresh Air Fan Series

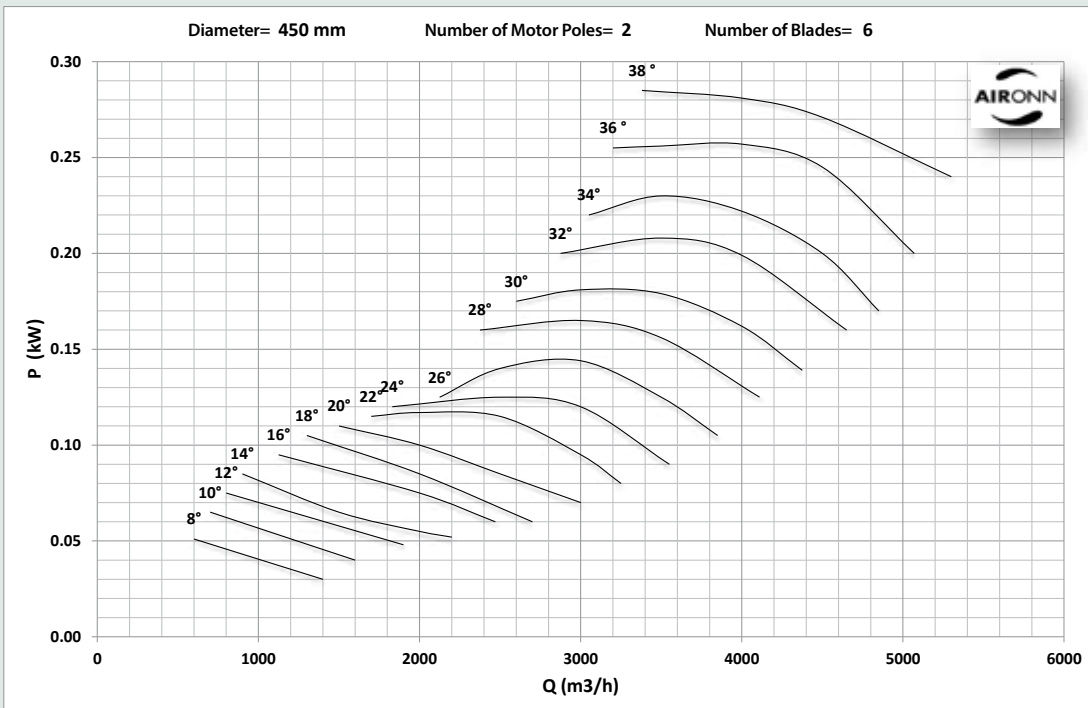
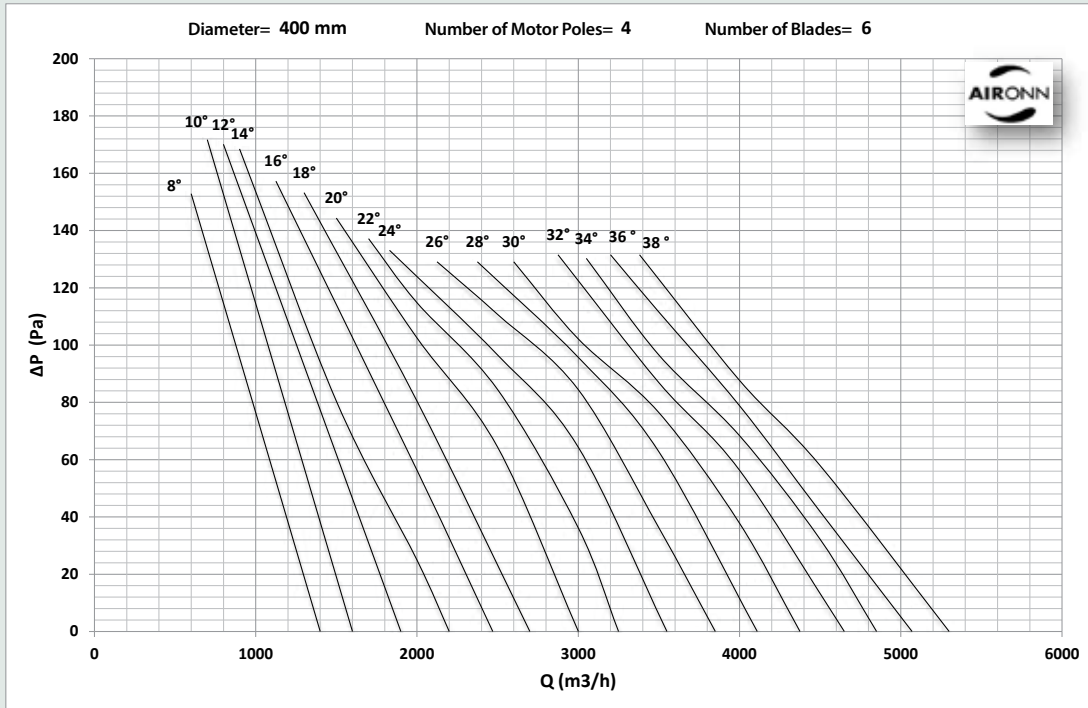

## Roof Type Axial (Vertical) Fresh Air Fan Series

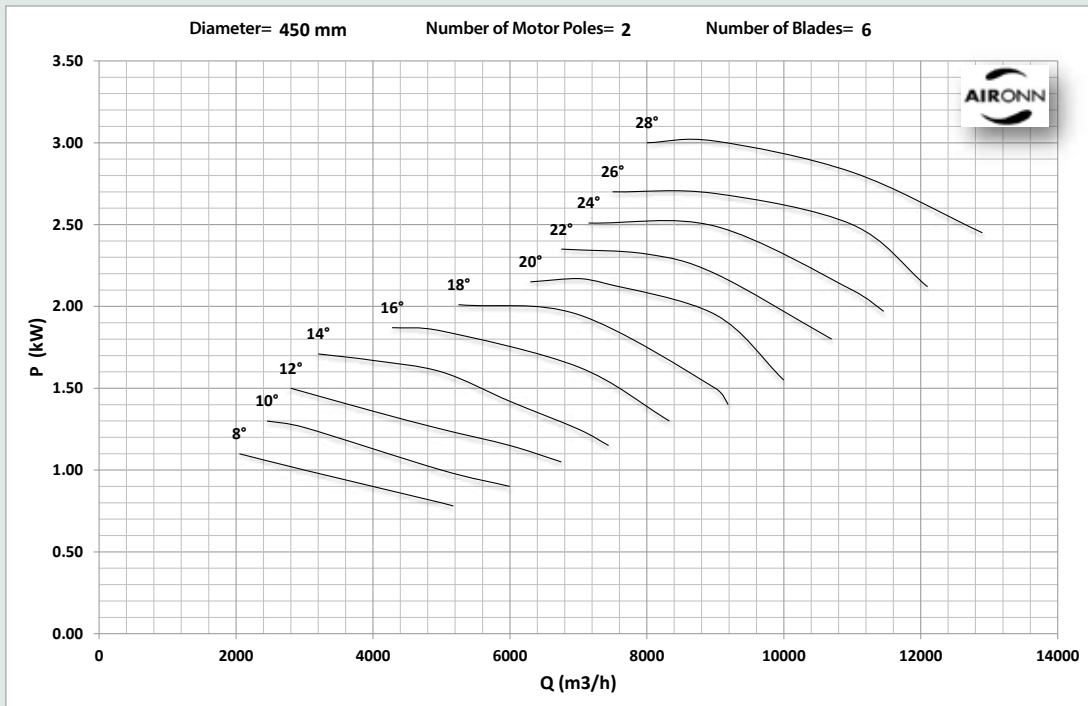
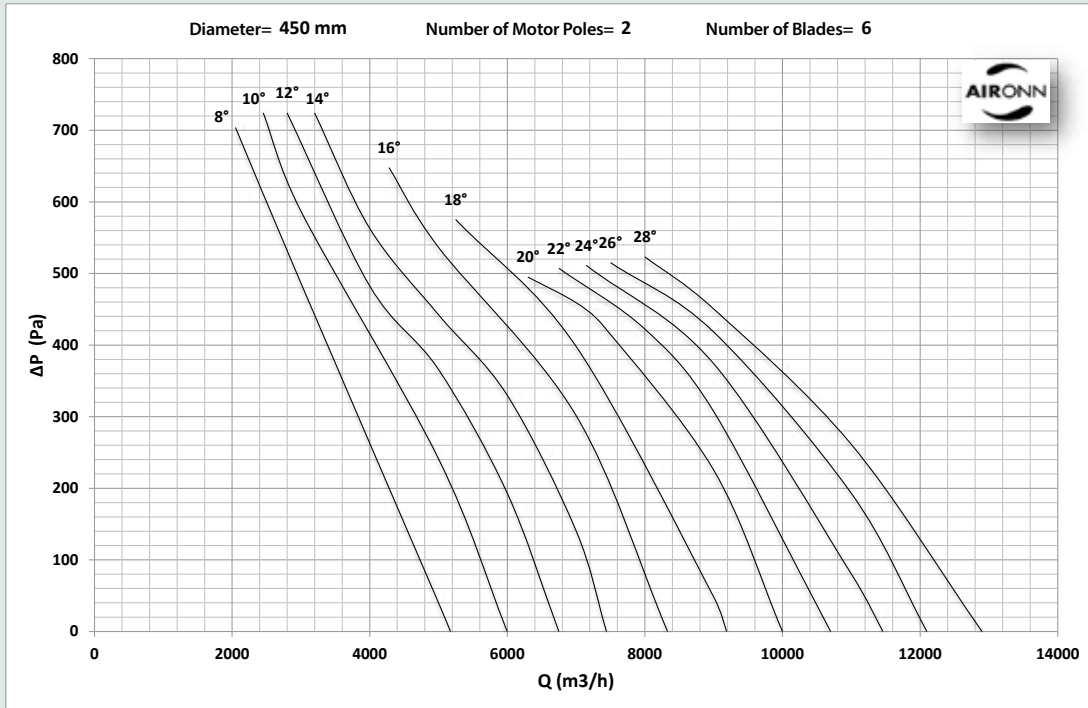

## Roof Type Axial (Vertical) Fresh Air Fan Series

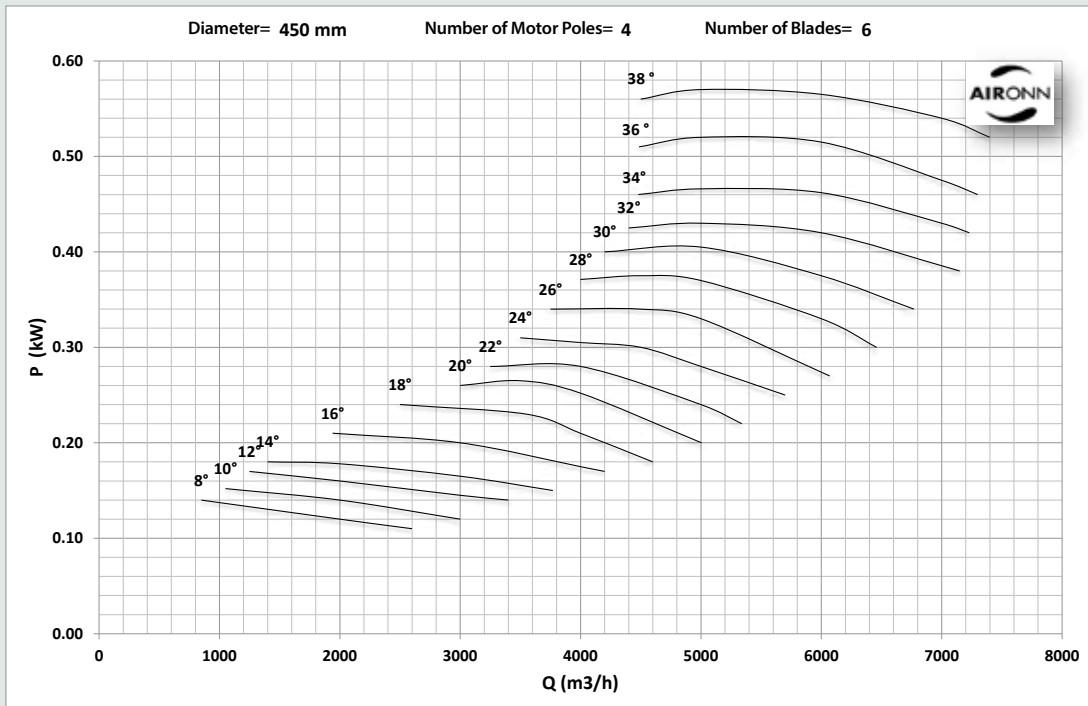
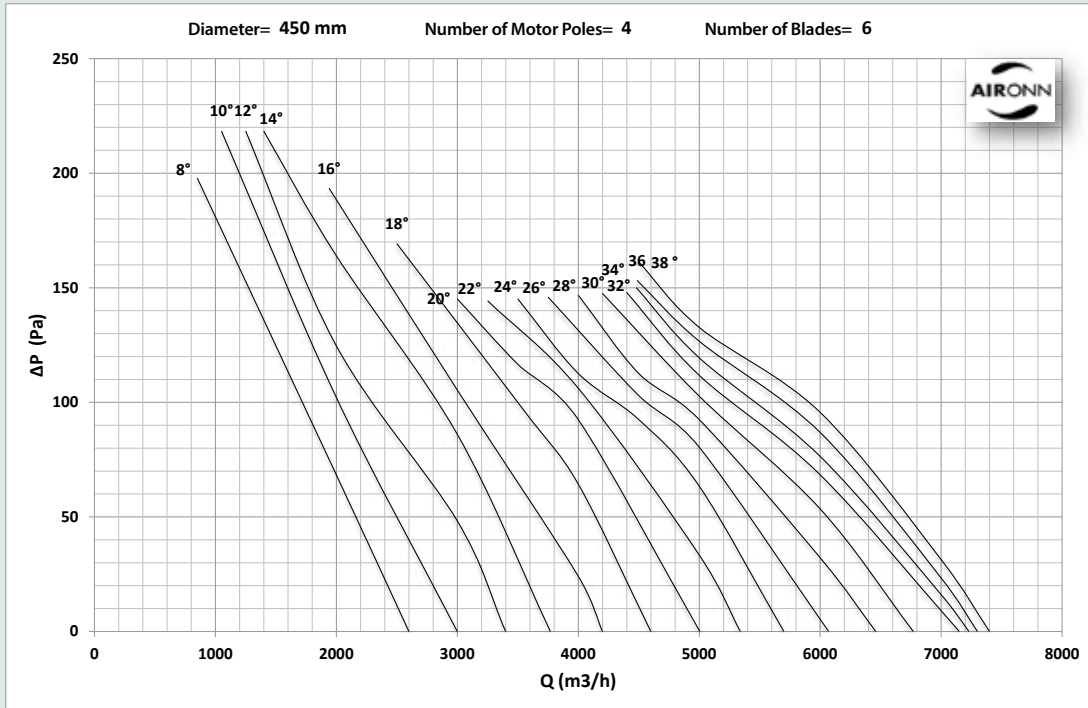

## Roof Type Axial (Vertical) Fresh Air Fan Series

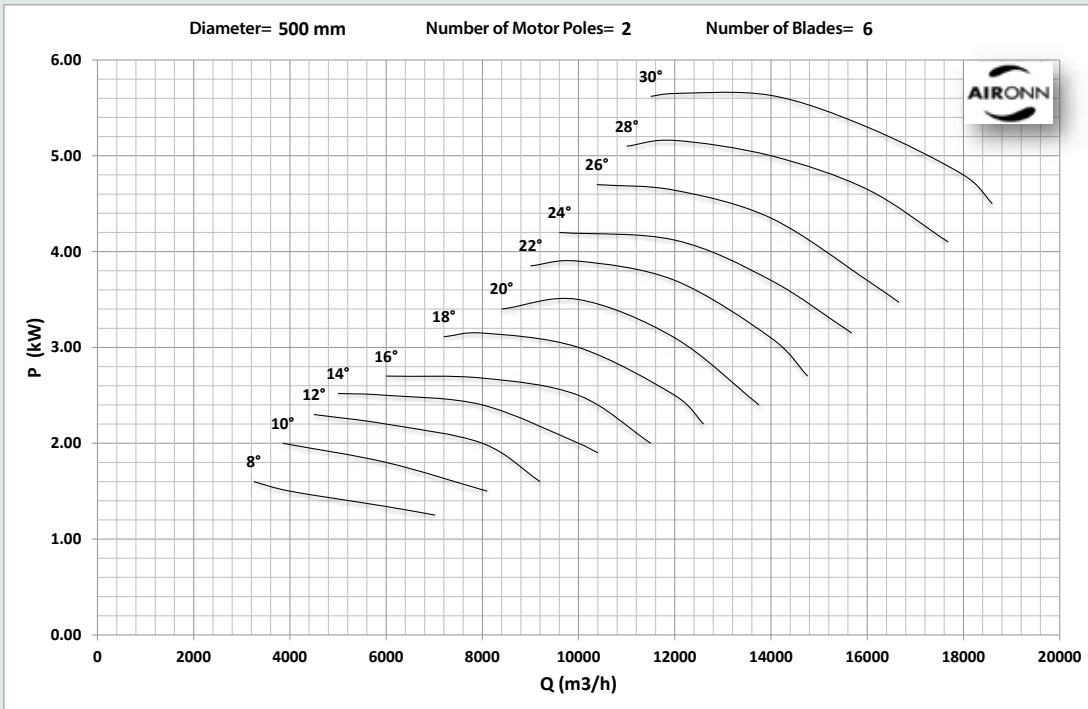
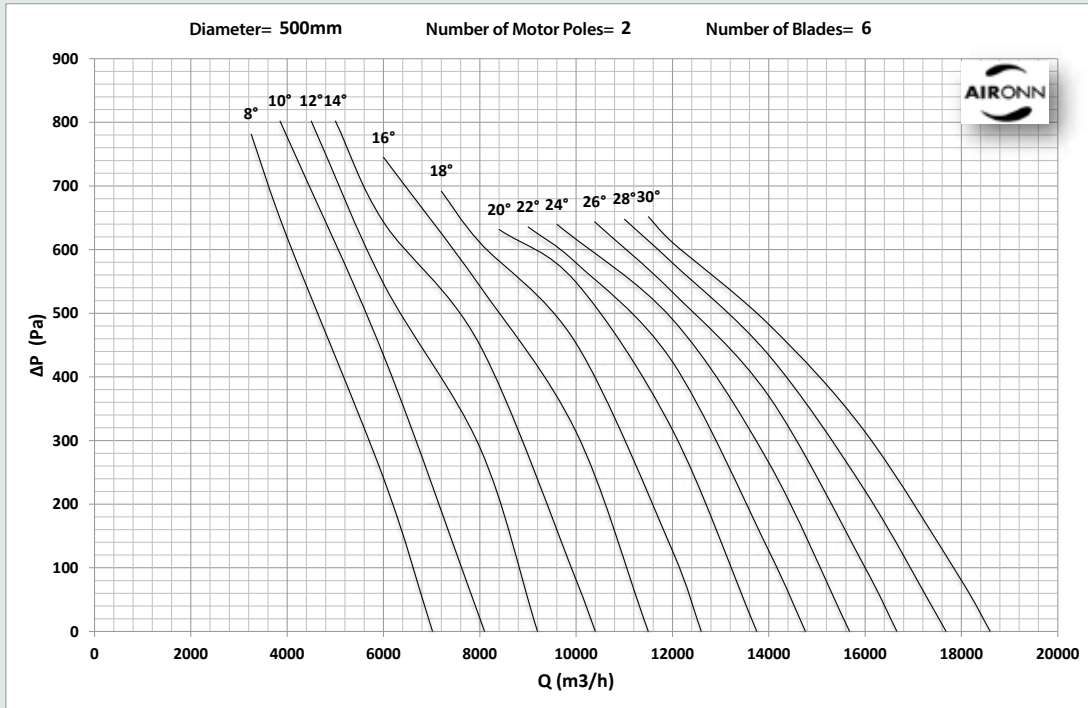

## Roof Type Axial (Vertical) Fresh Air Fan Series

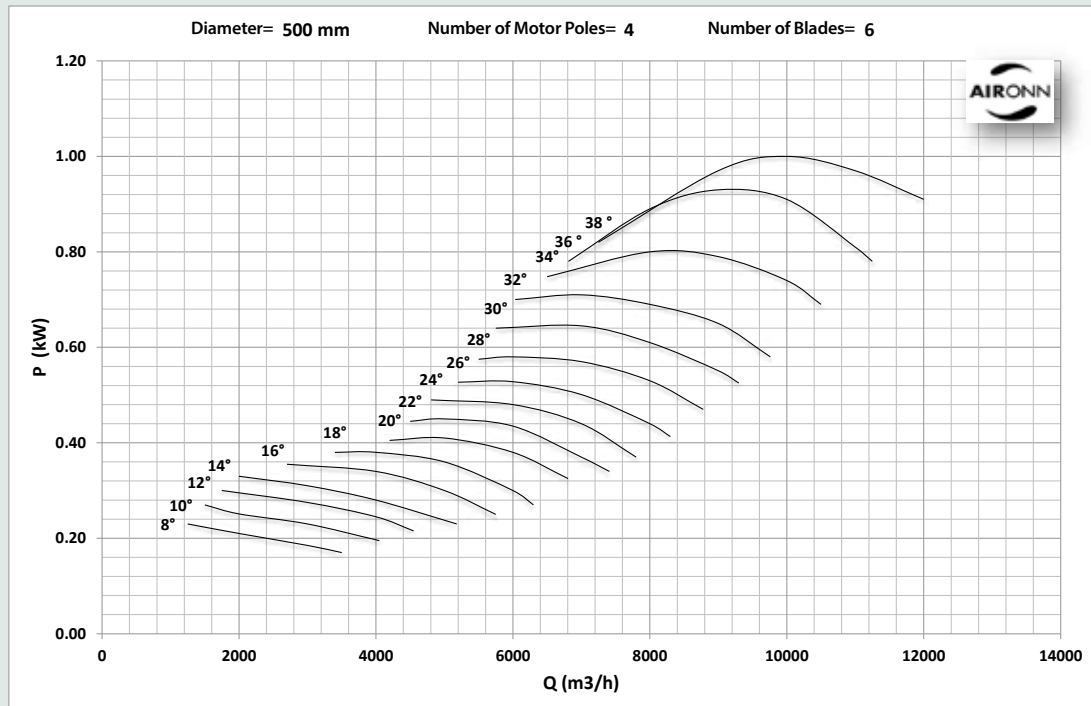
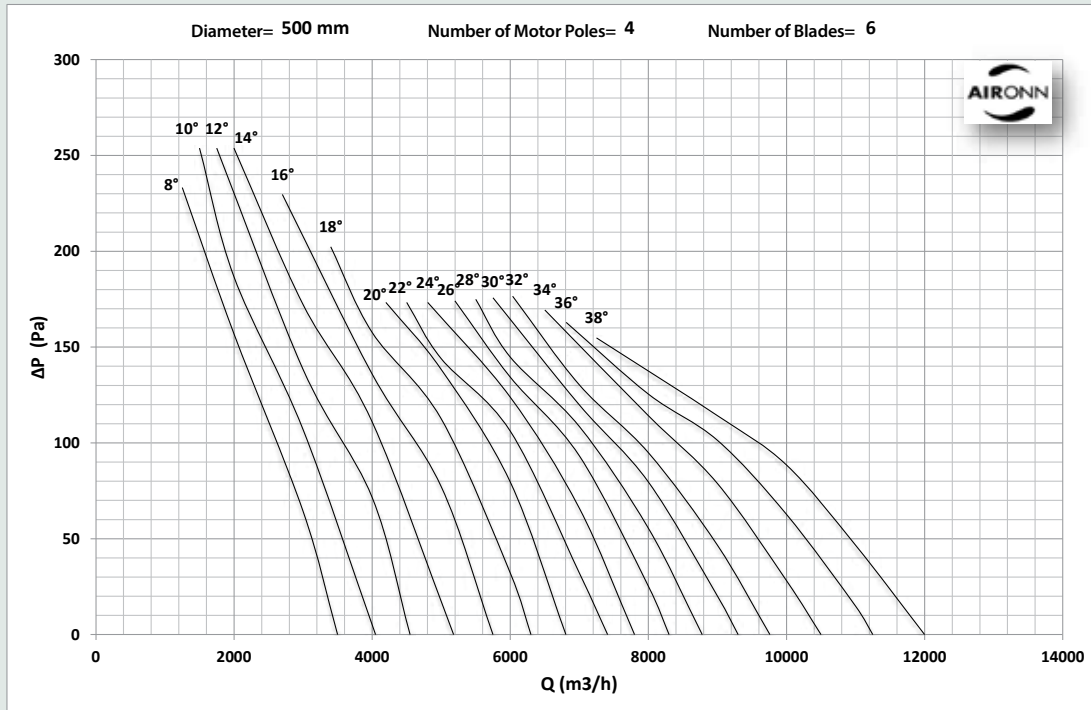

## Roof Type Axial (Vertical) Fresh Air Fan Series

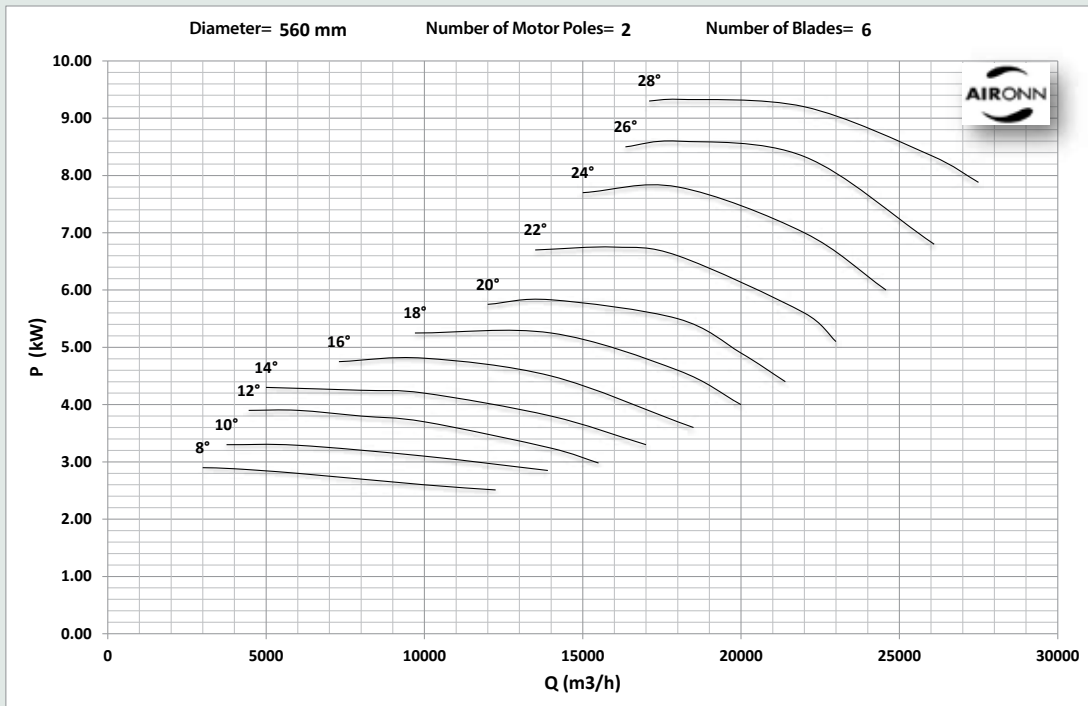
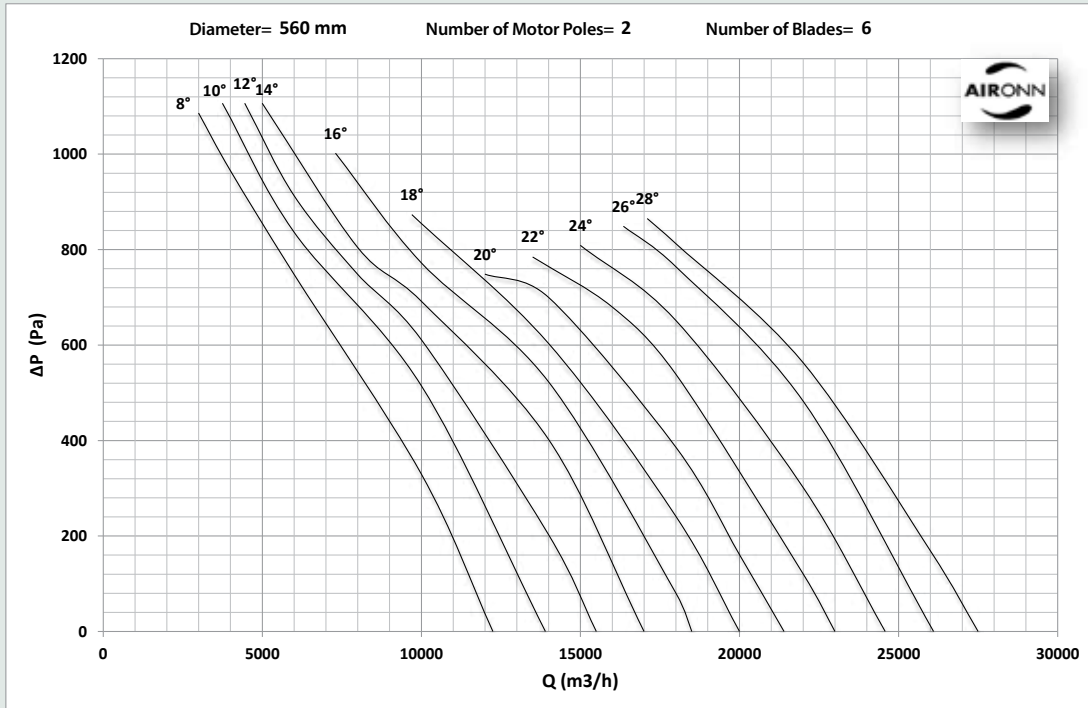

## Roof Type Axial (Vertical) Fresh Air Fan Series

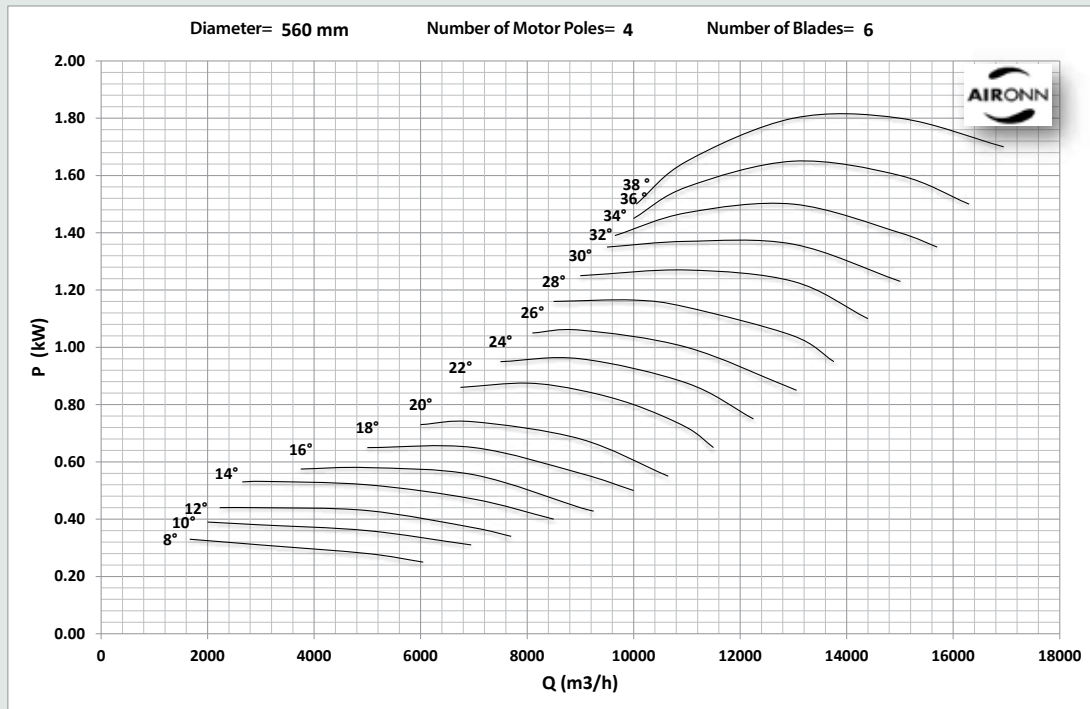
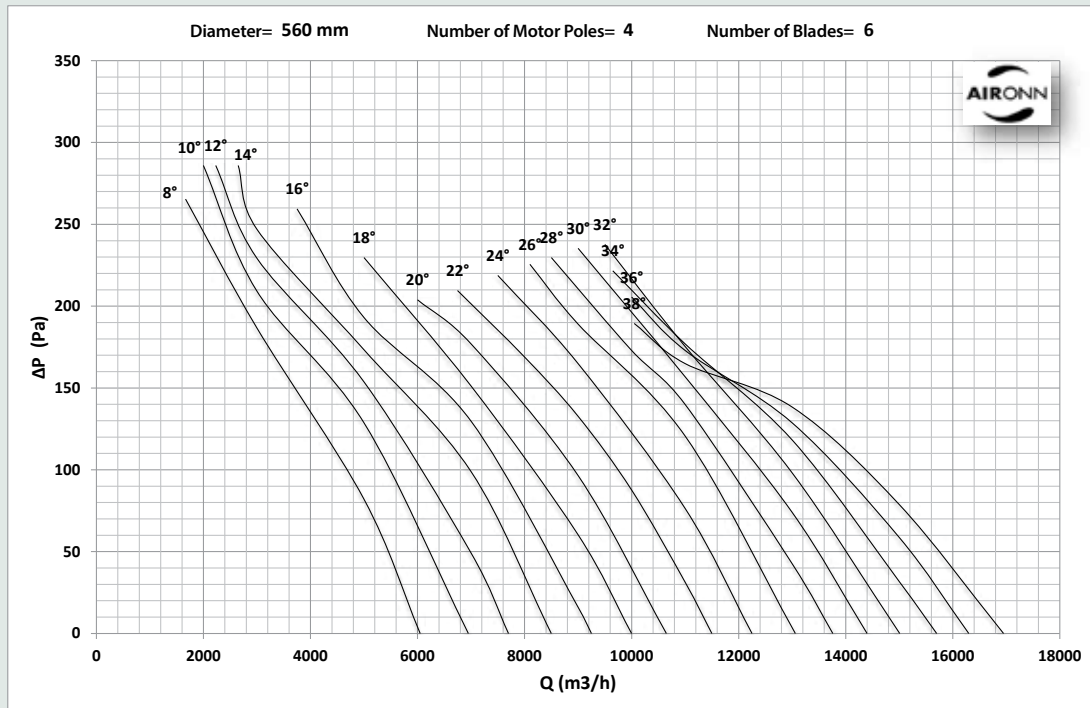



## Roof Type Axial (Vertical) Fresh Air Fan Series

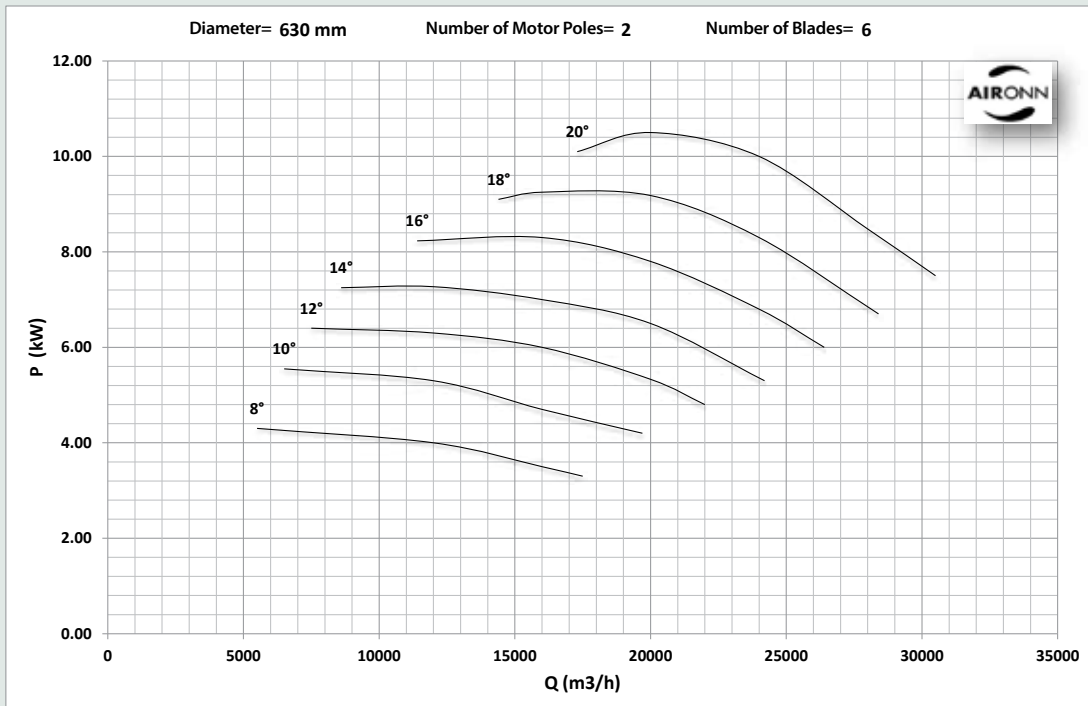
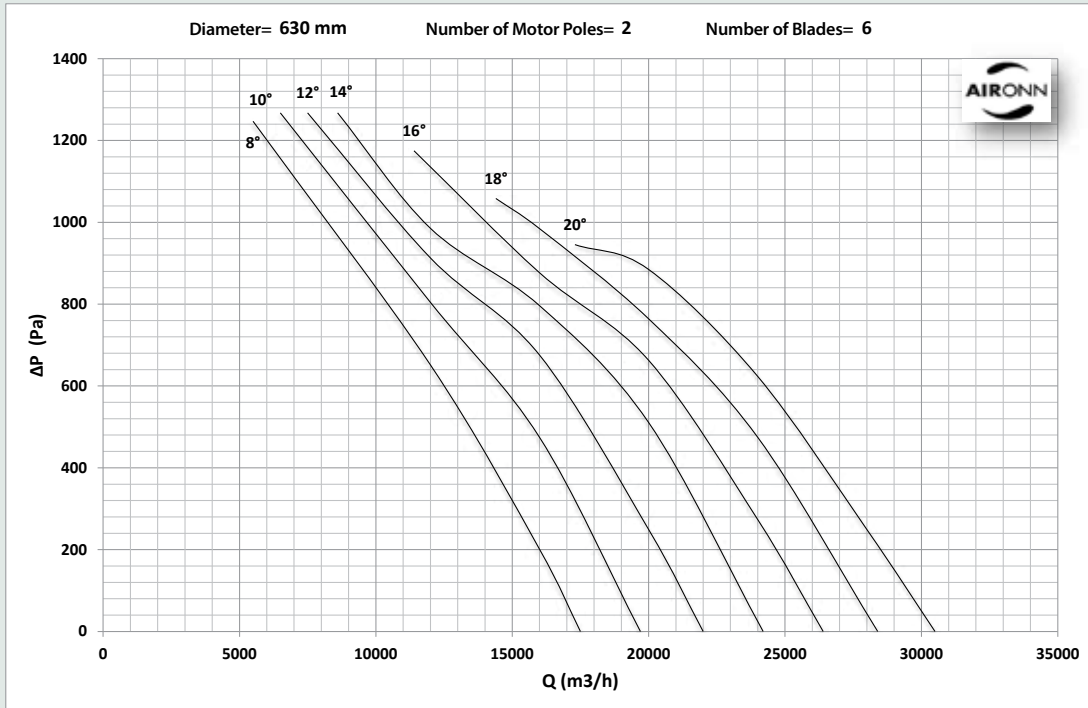

## Roof Type Axial (Vertical) Fresh Air Fan Series

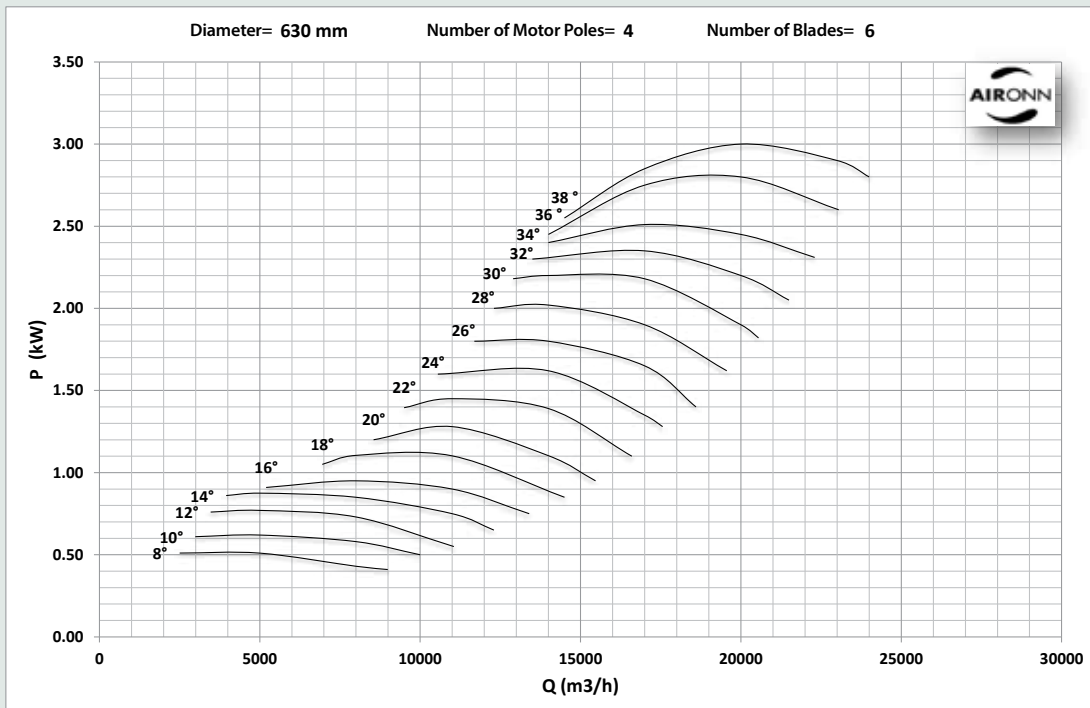
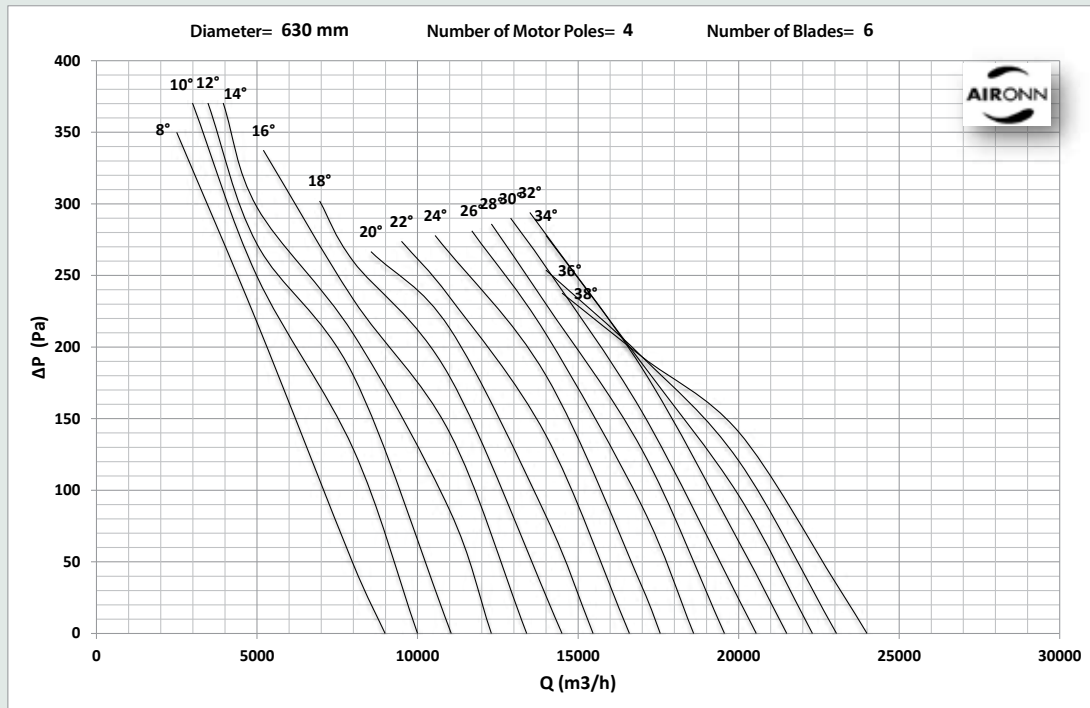

## Roof Type Axial (Vertical) Fresh Air Fan Series

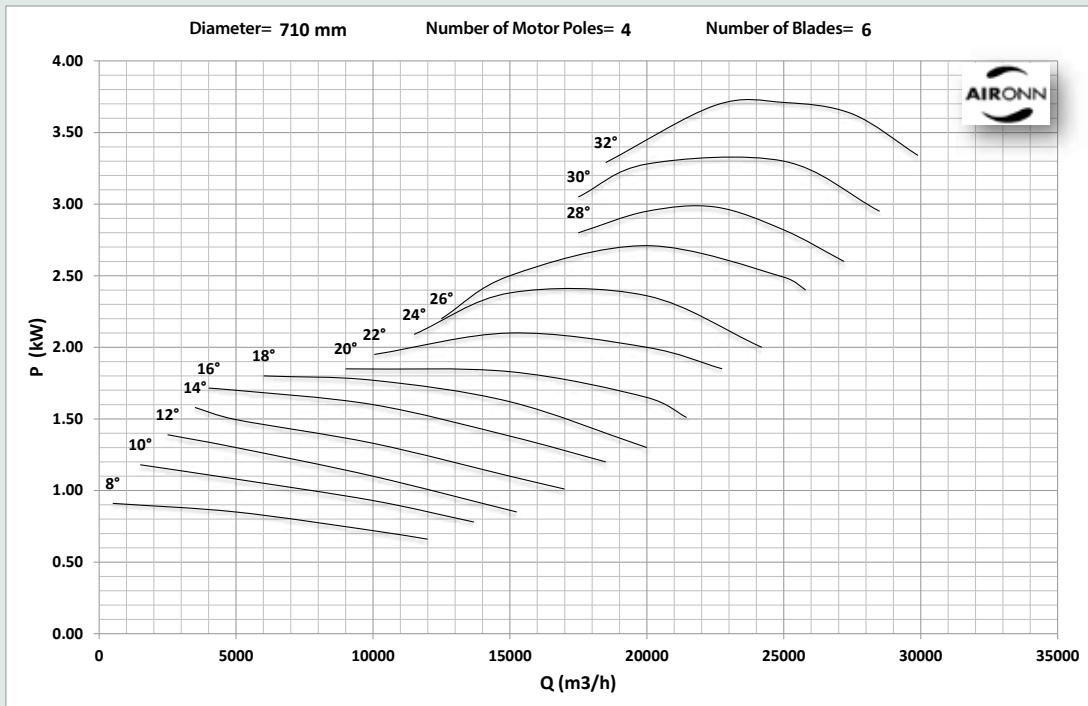
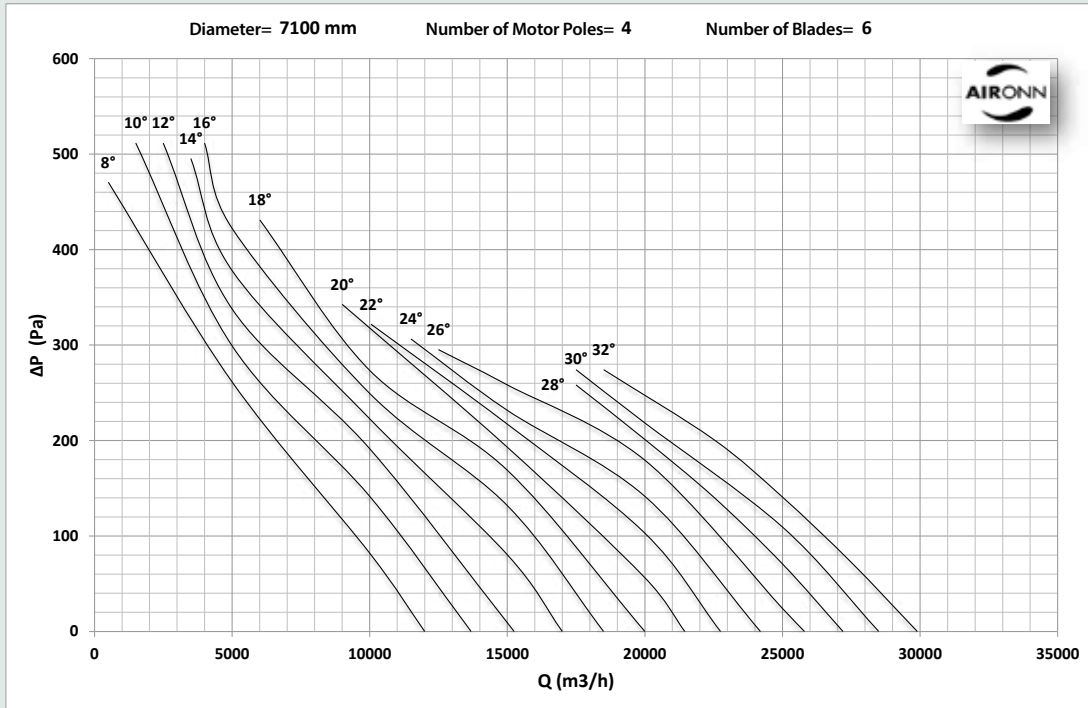

## Roof Type Axial (Vertical) Fresh Air Fan Series

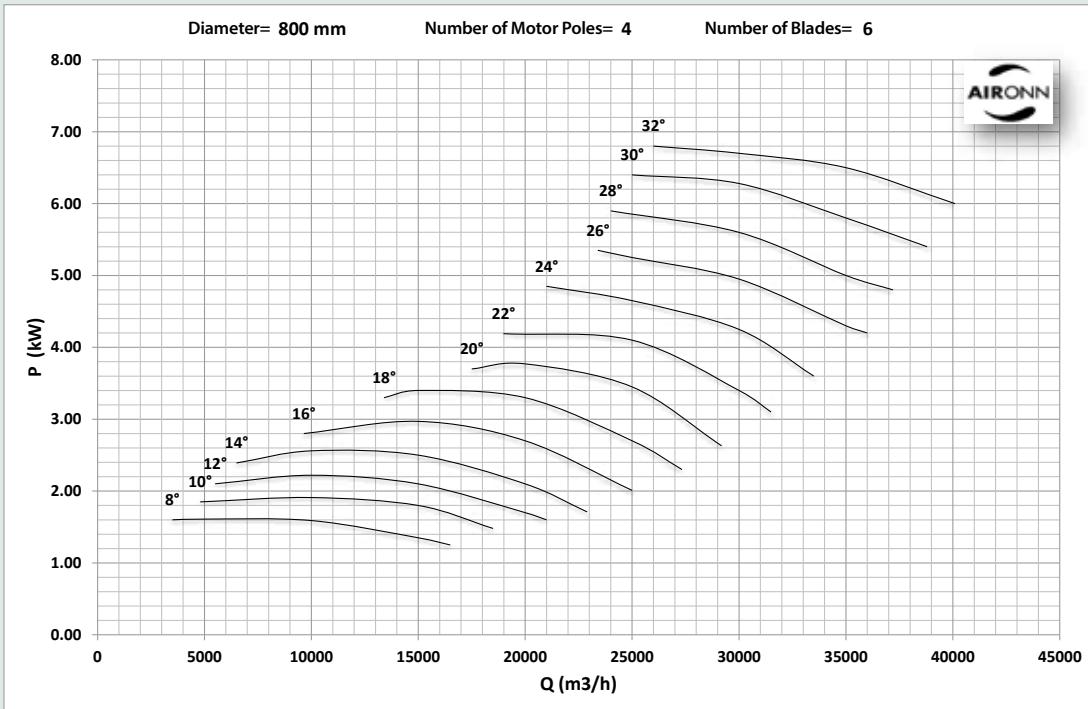
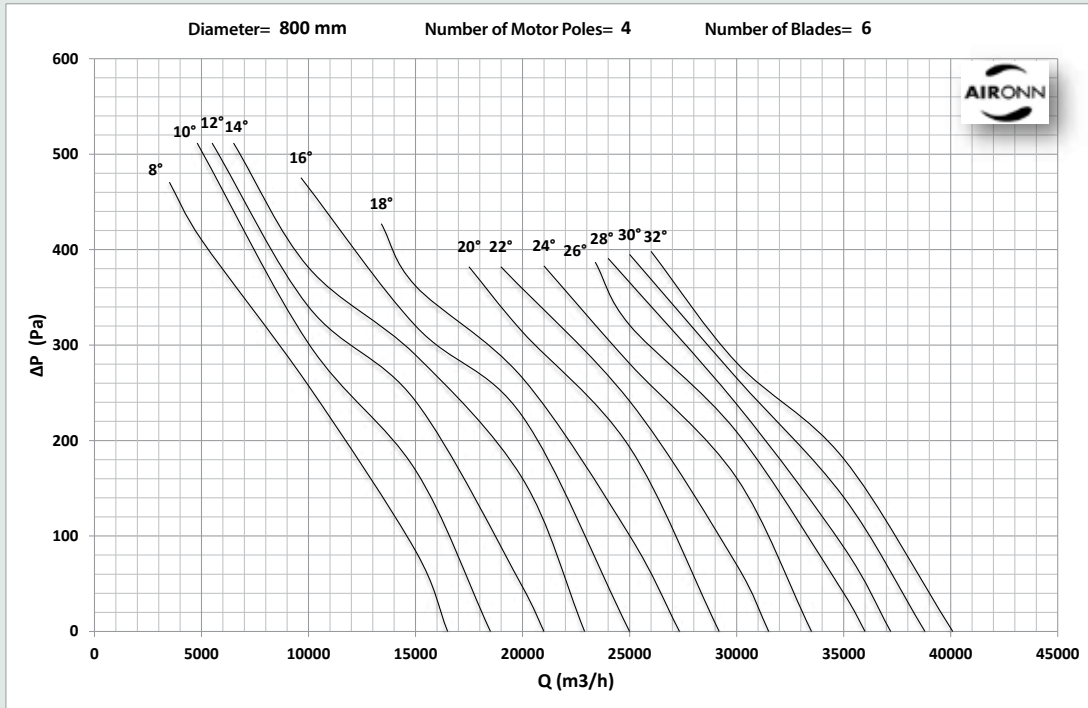

## Roof Type Axial (Vertical) Fresh Air Fan Series

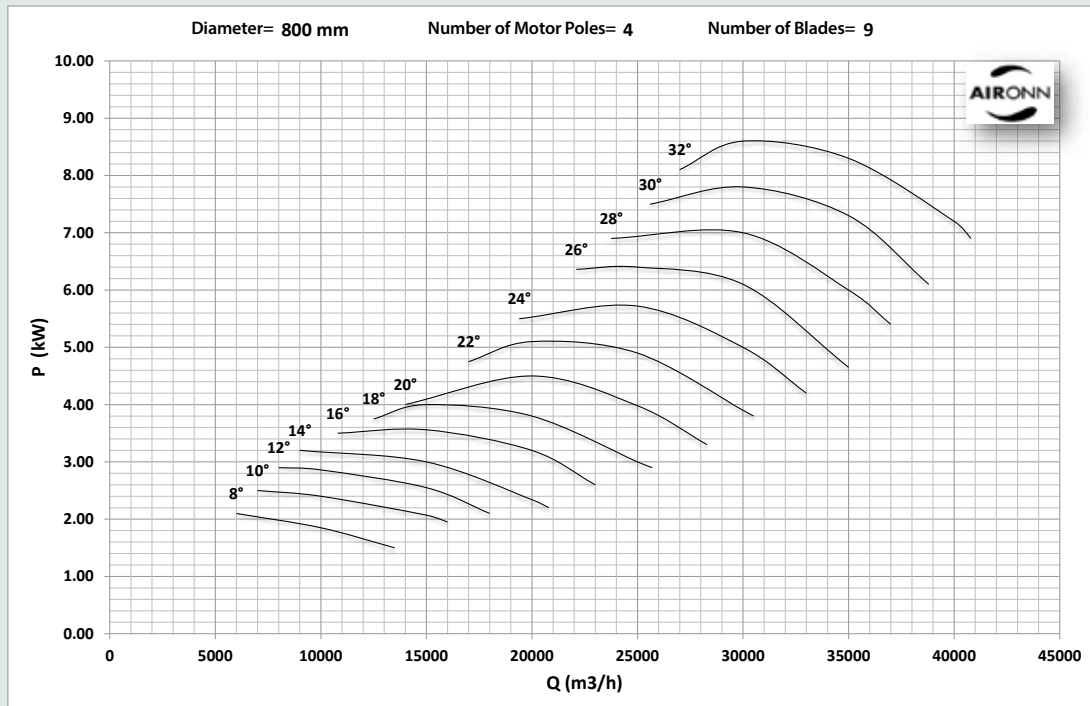
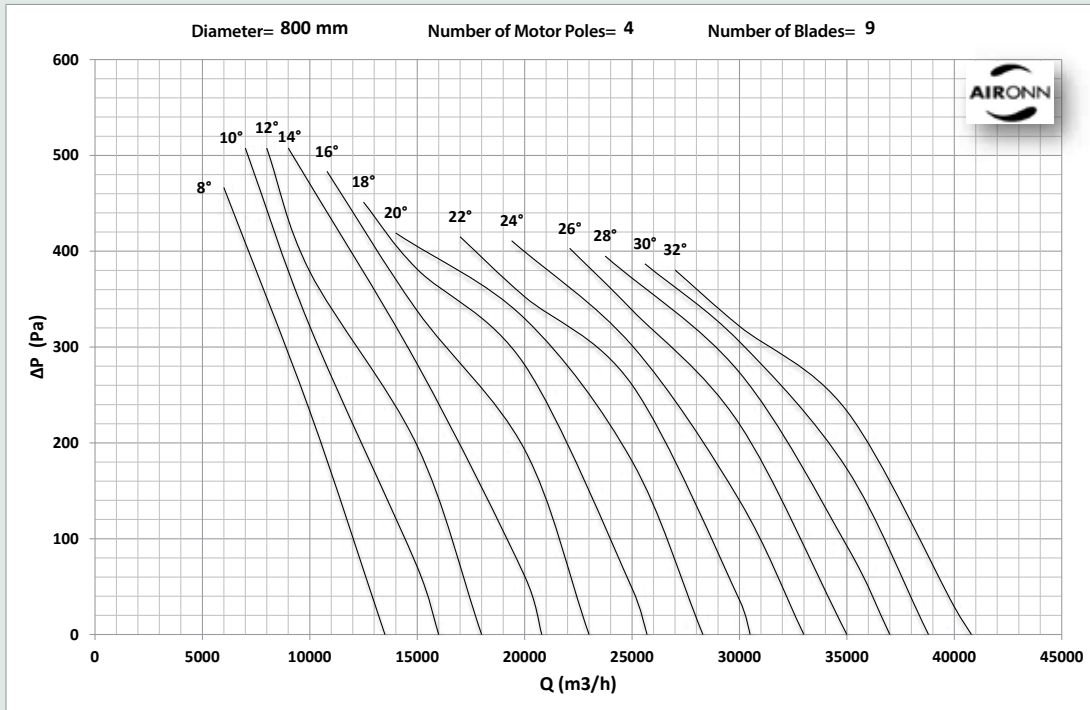

## Roof Type Axial (Vertical) Fresh Air Fan Series

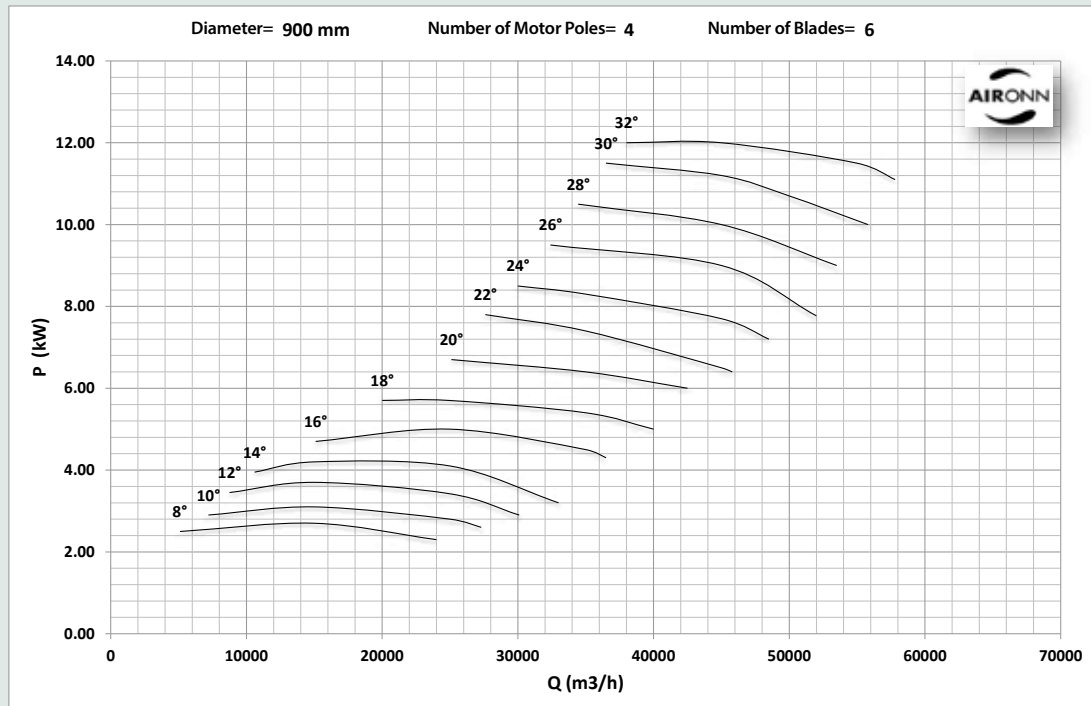
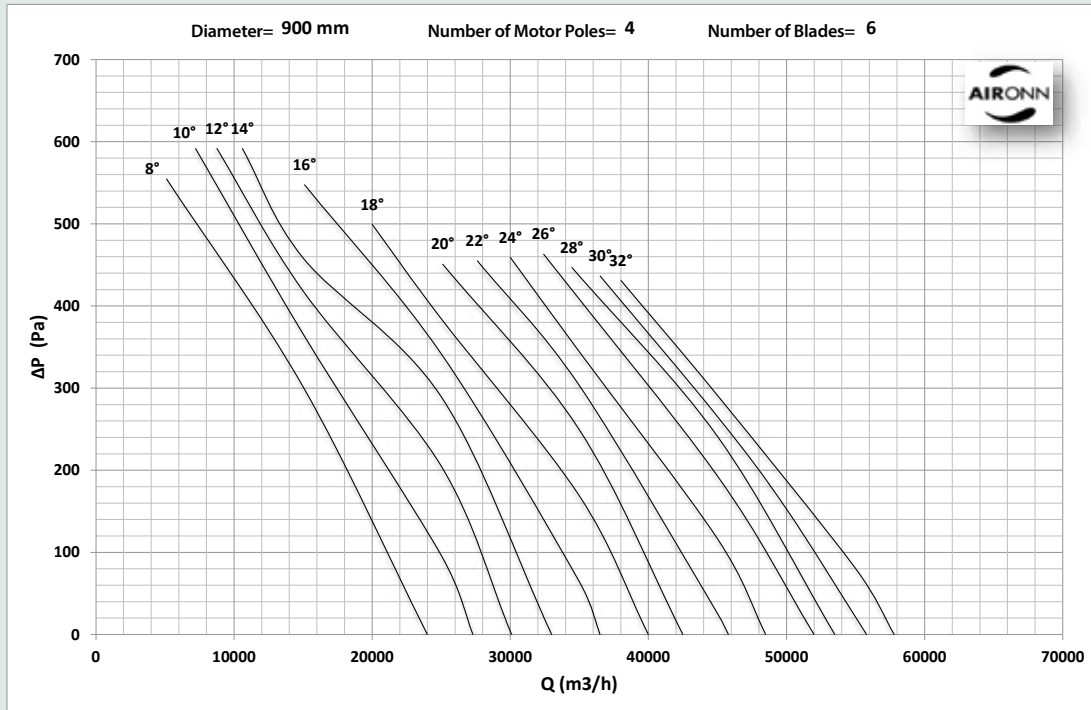

## Roof Type Axial (Vertical) Fresh Air Fan Series

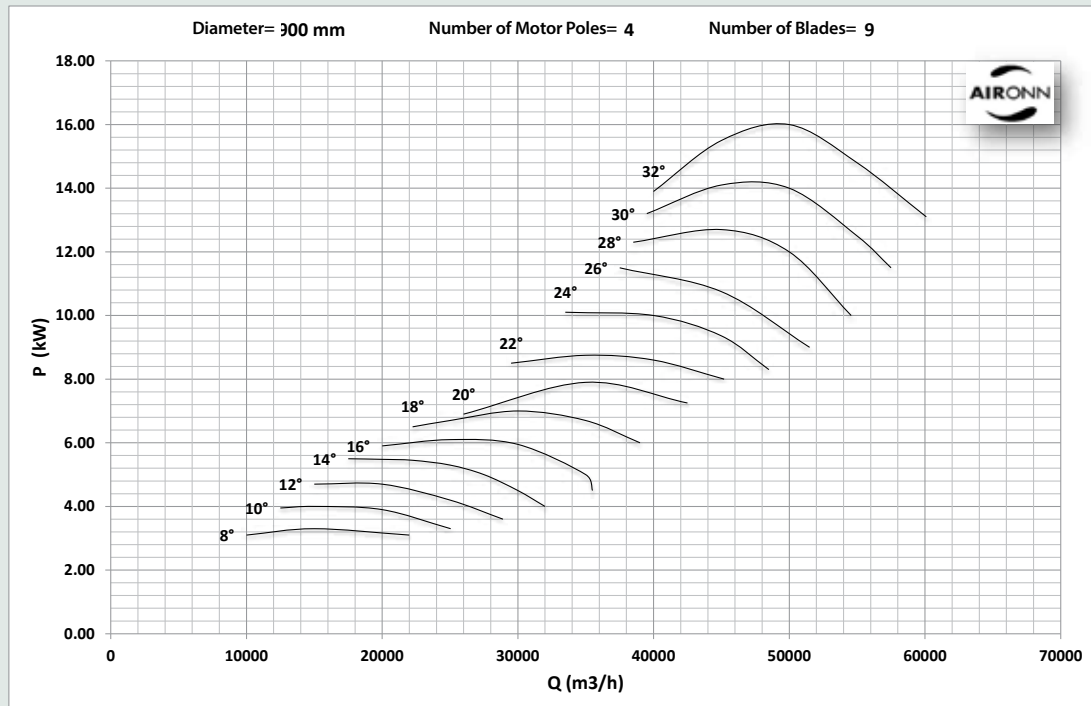
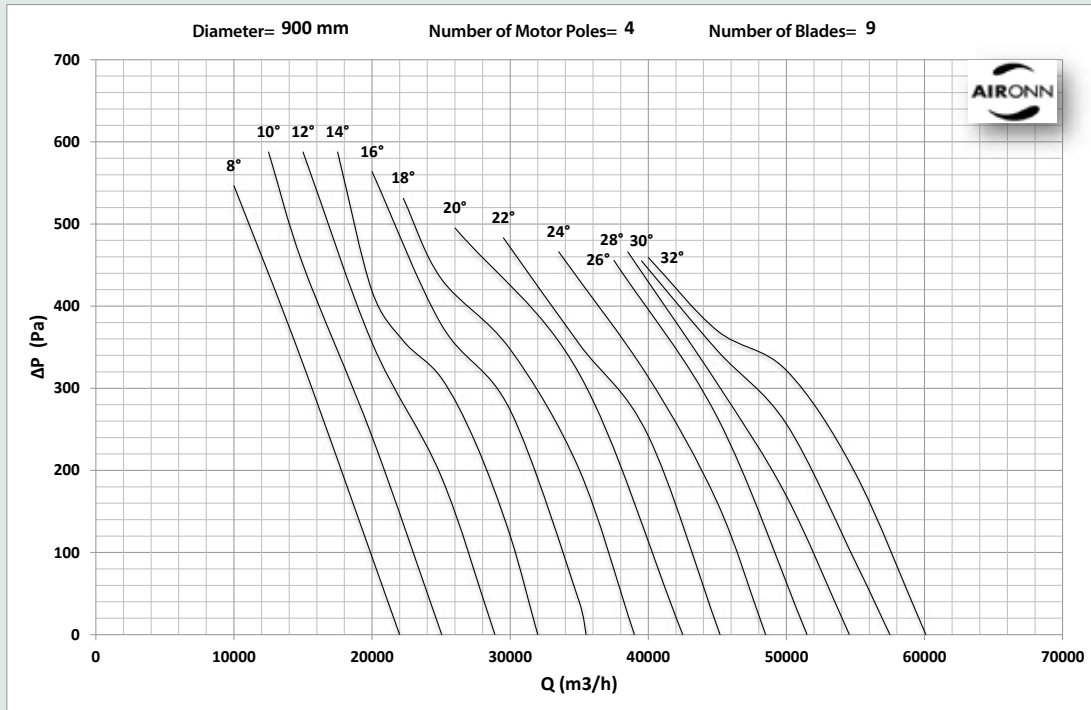

## Roof Type Axial (Vertical) Fresh Air Fan Series

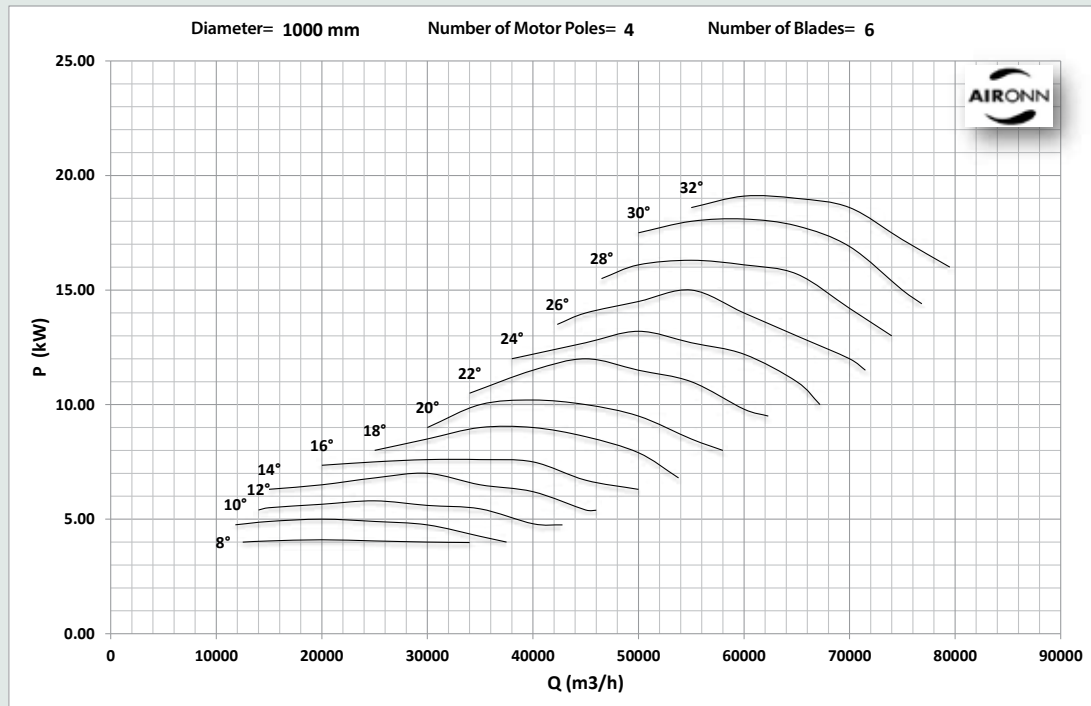
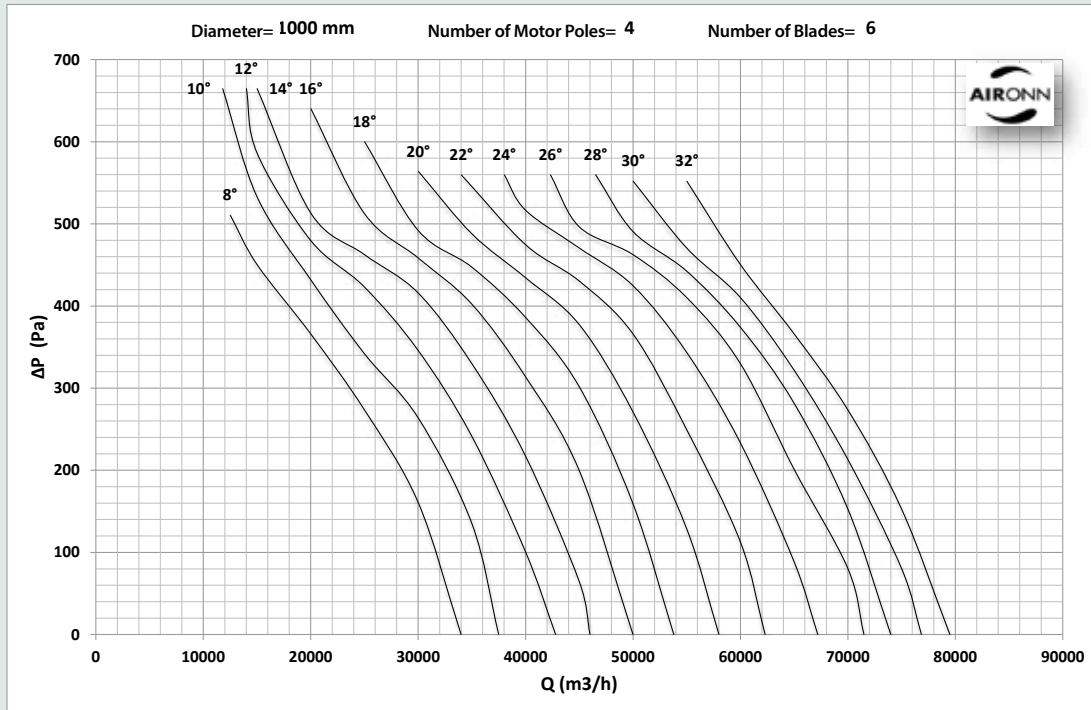



## Roof Type Axial (Vertical) Fresh Air Fan Series

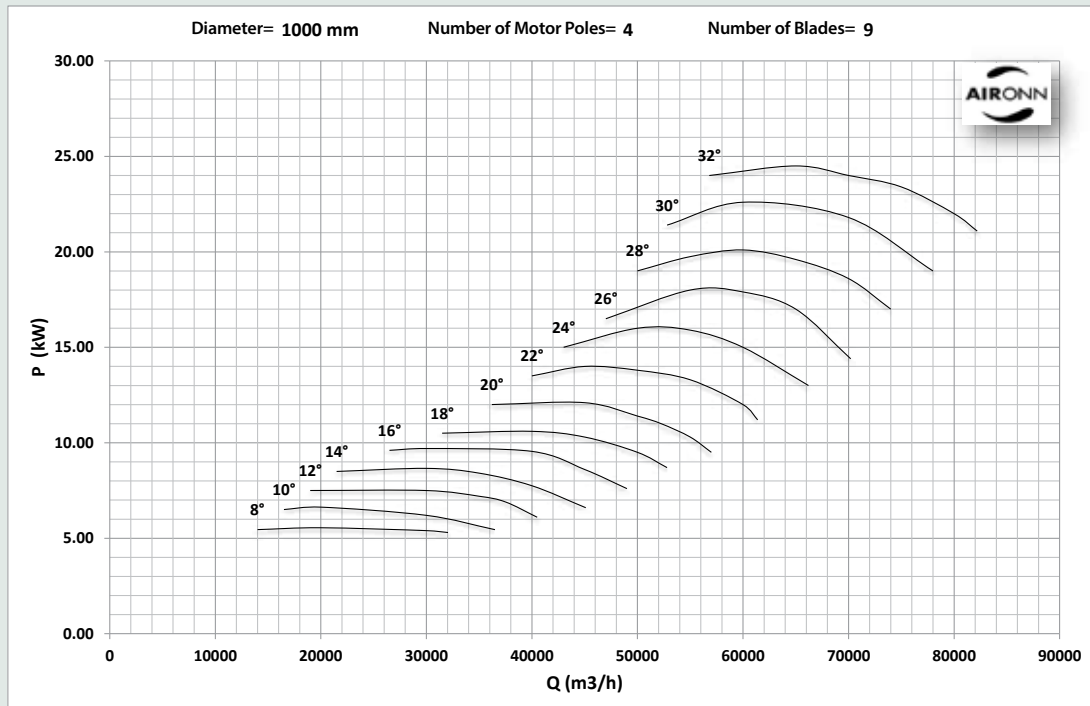
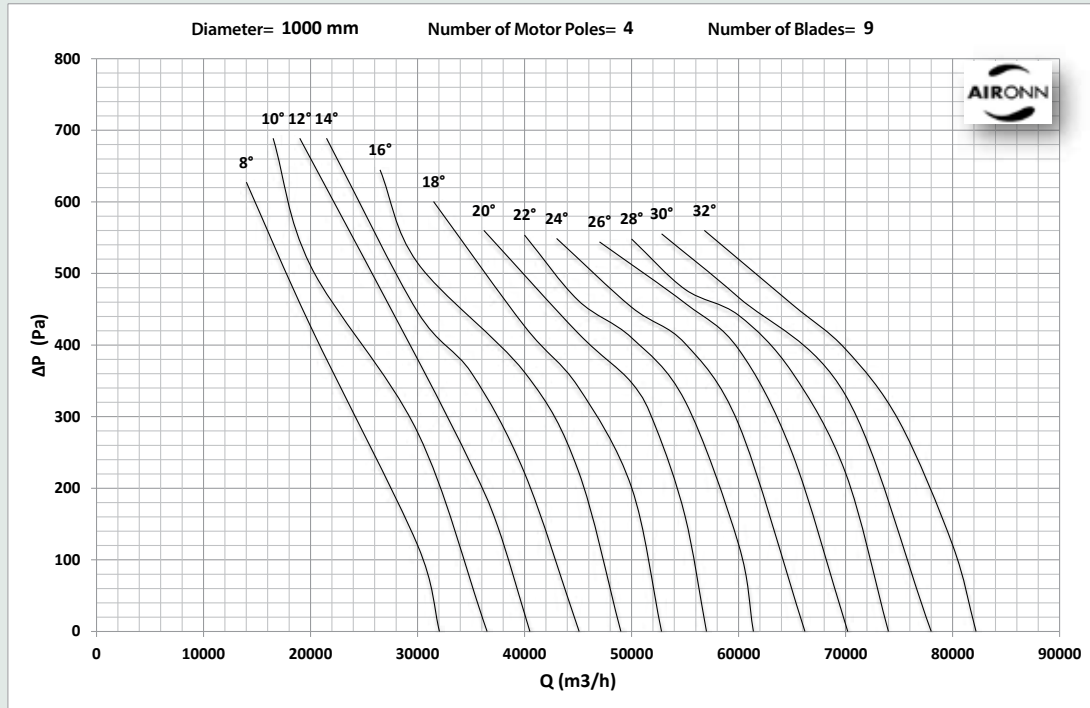

## Roof Type Axial (Vertical) Fresh Air Fan Series

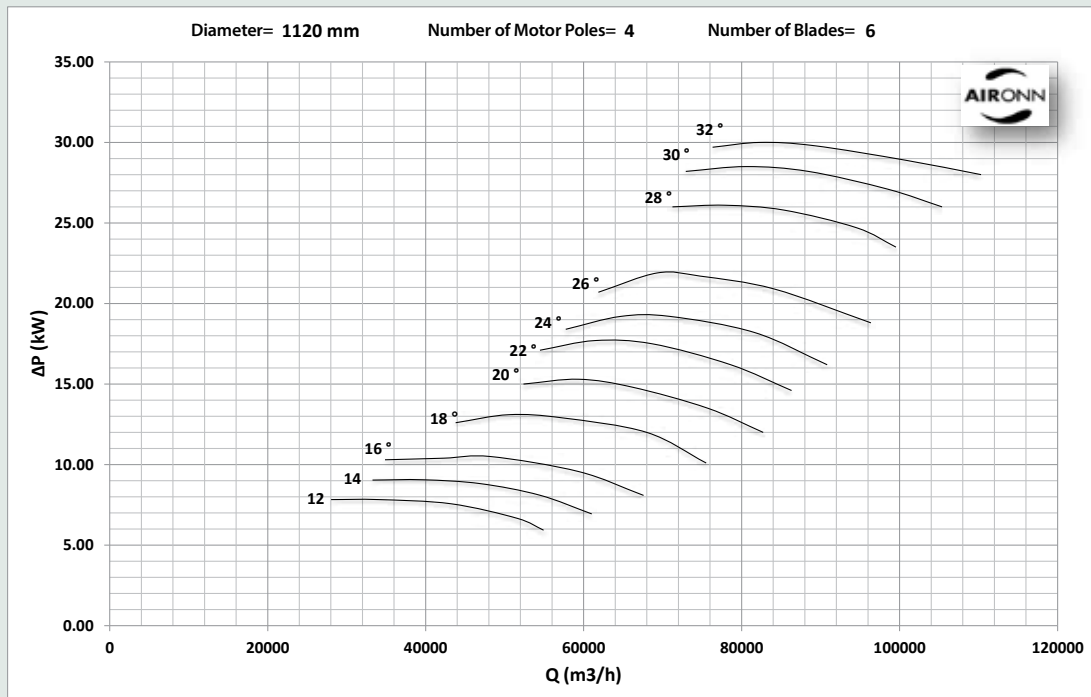
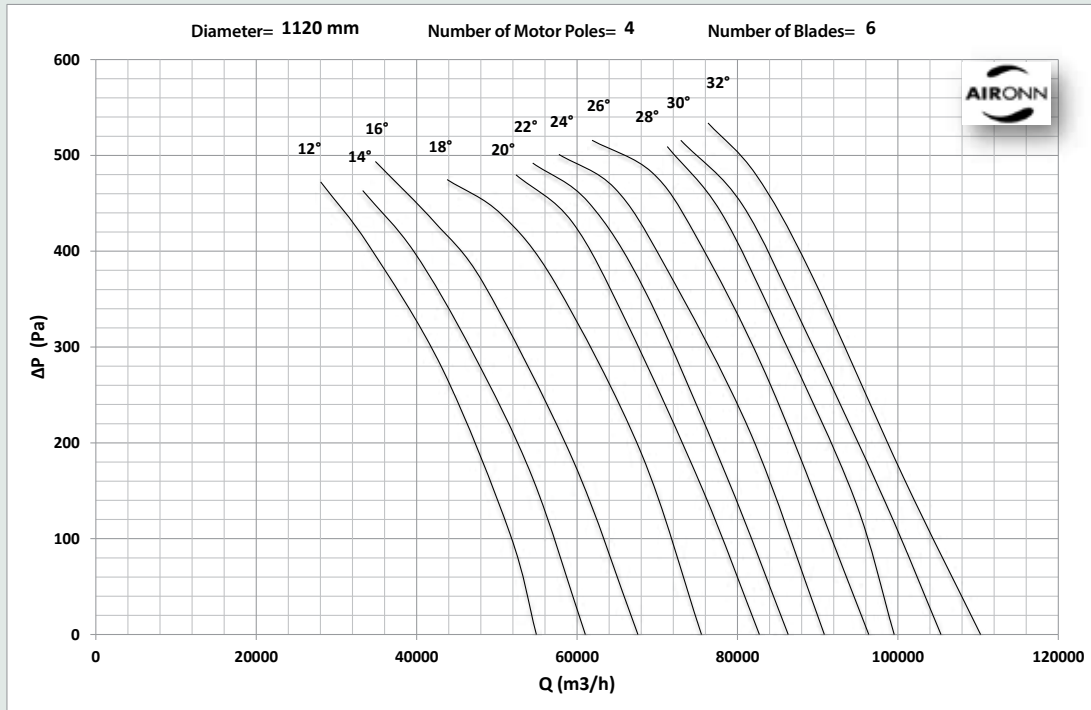

# Roof Type Axial (Vertical) Fresh Air Fan Series

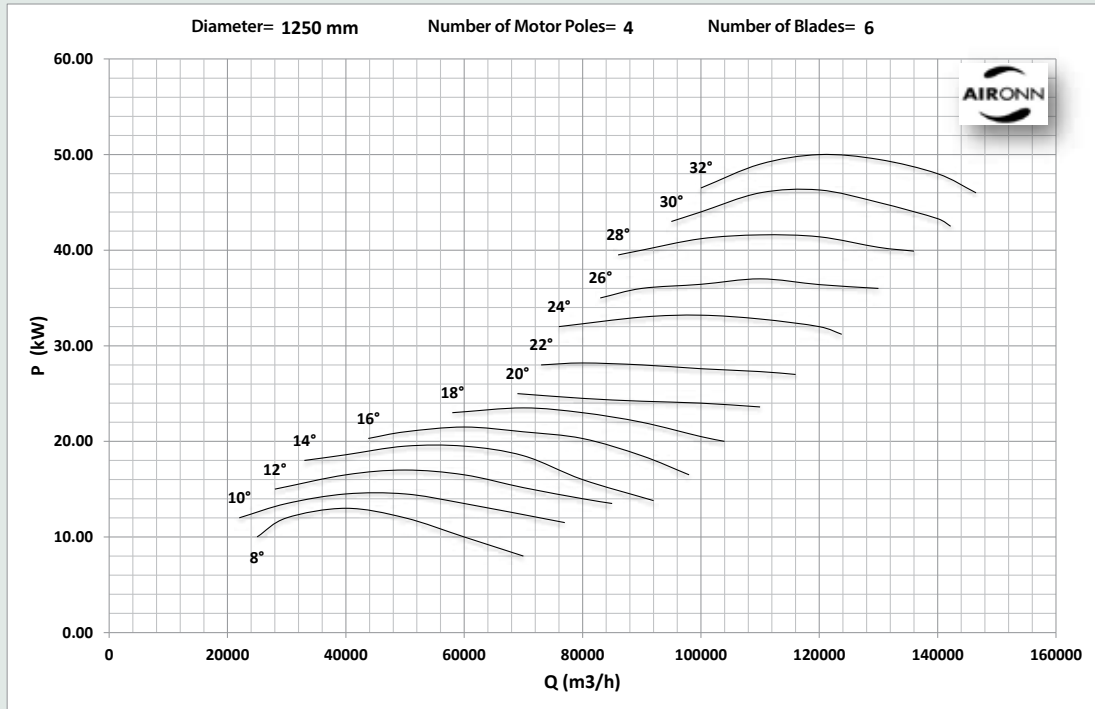
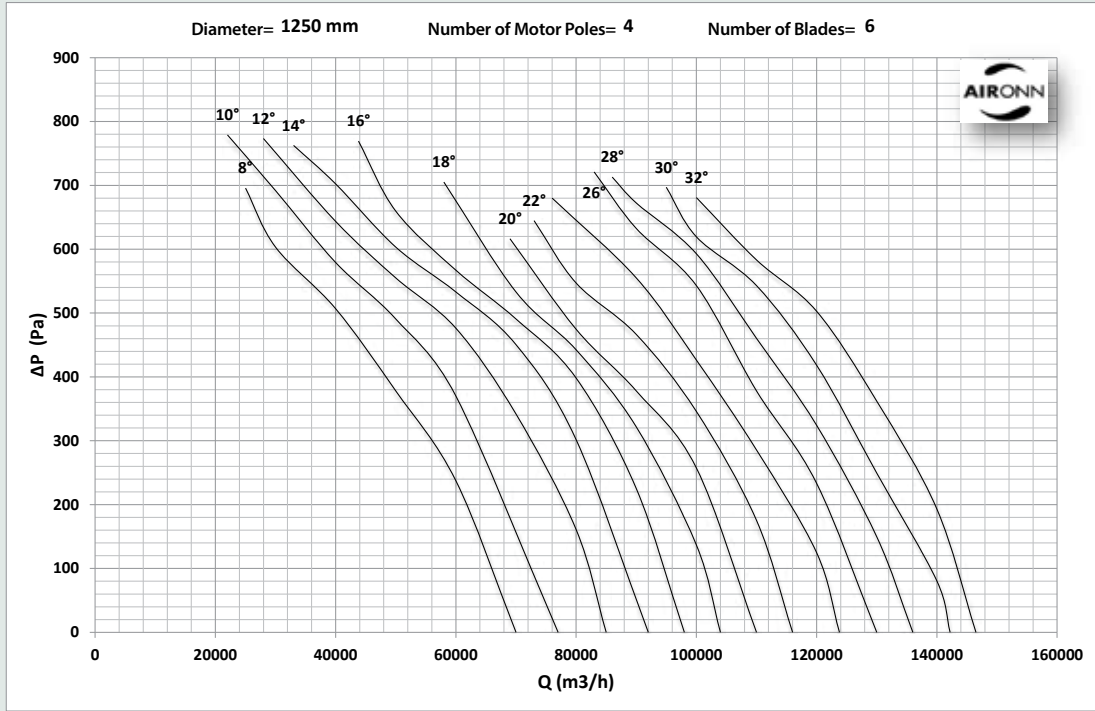

## Roof Type Axial (Vertical) Fresh Air Fan Series

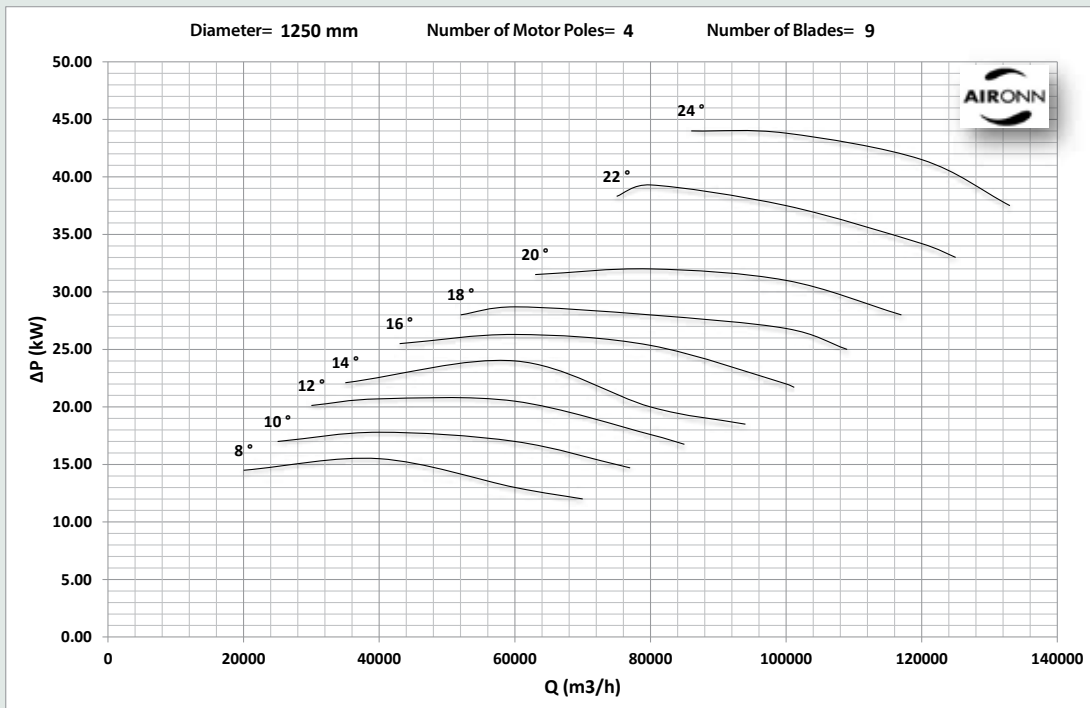
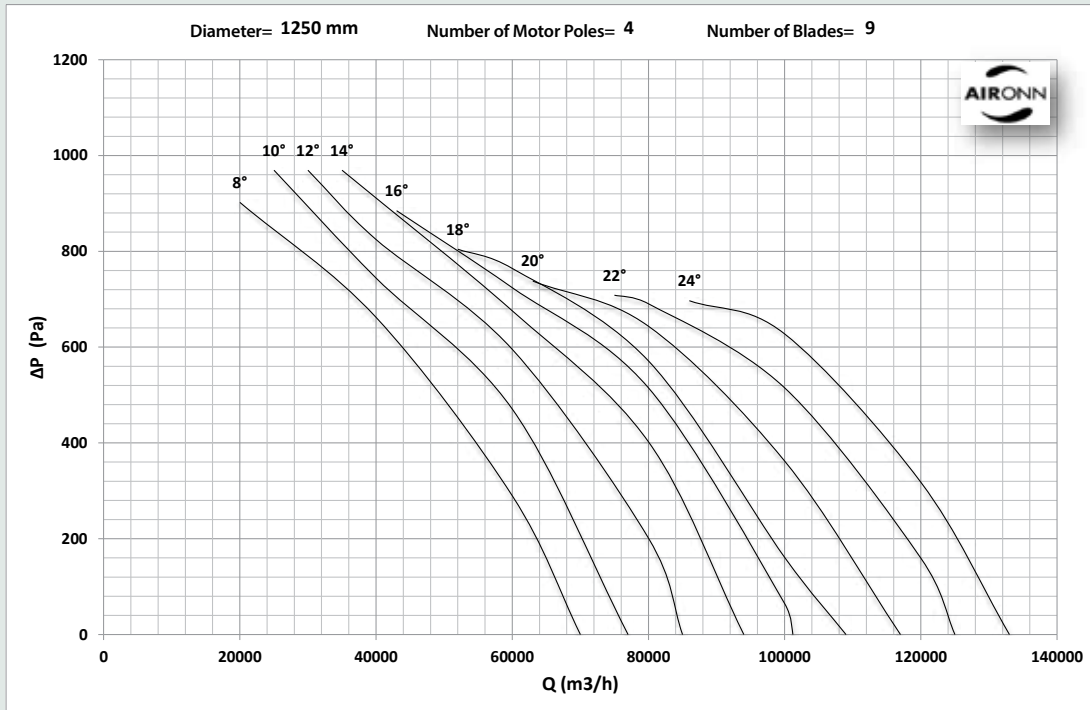

# Roof Type Axial (Vertical) Smoke Exhaust Fan Series

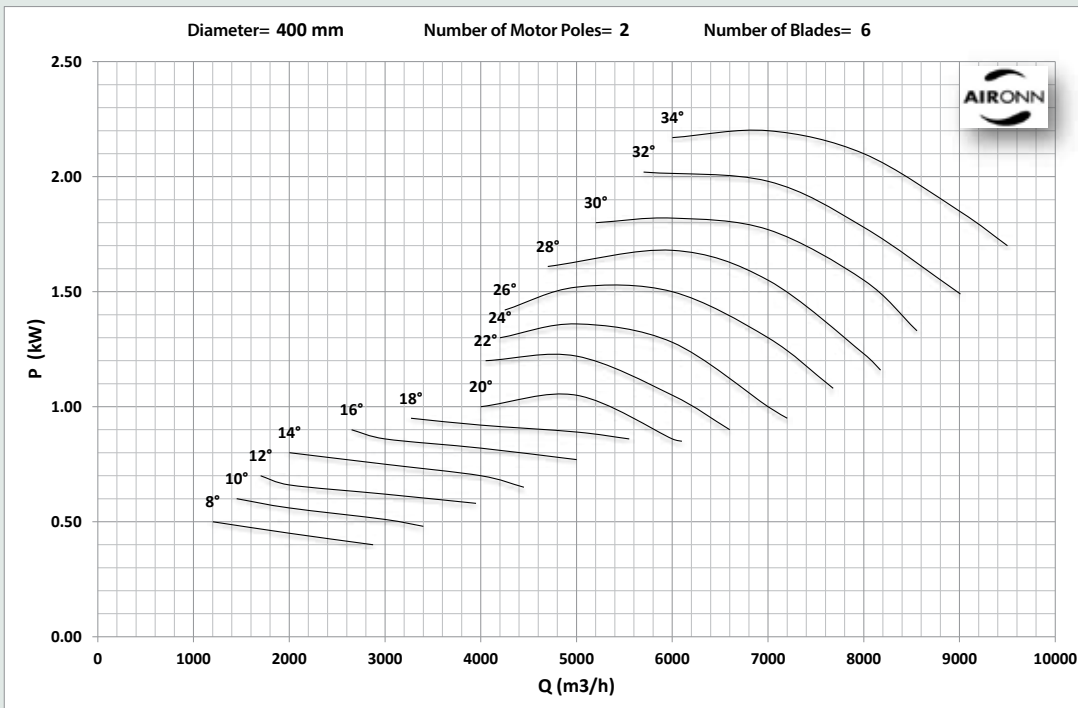
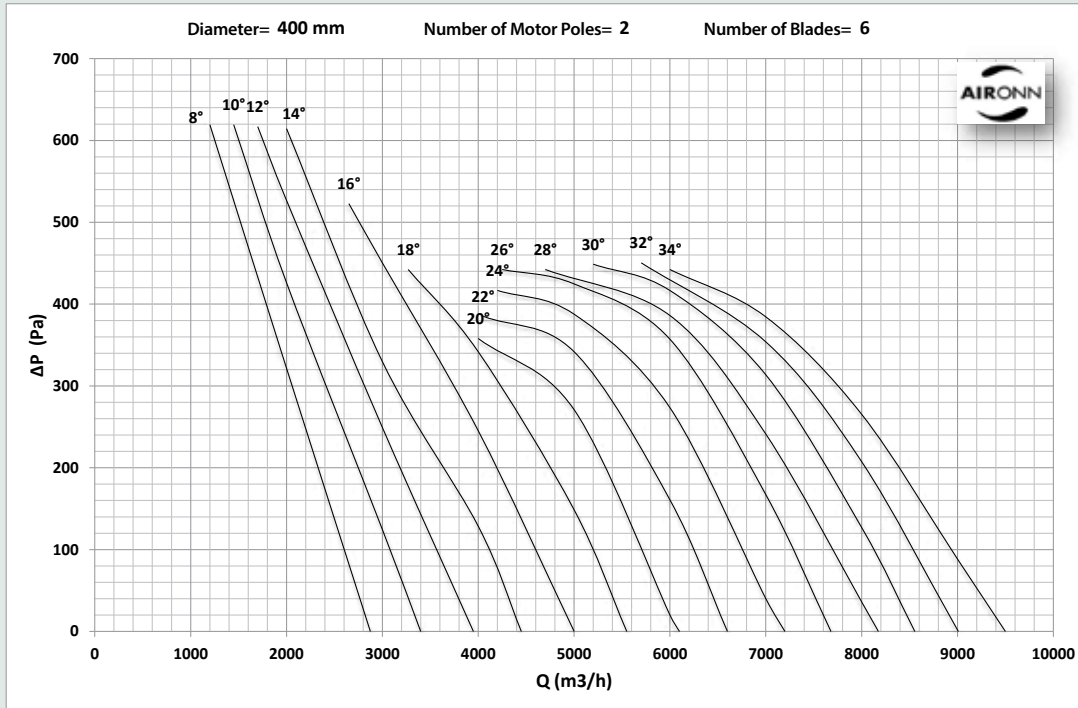

# Roof Type Axial (Vertical) Smoke Exhaust Fan Series

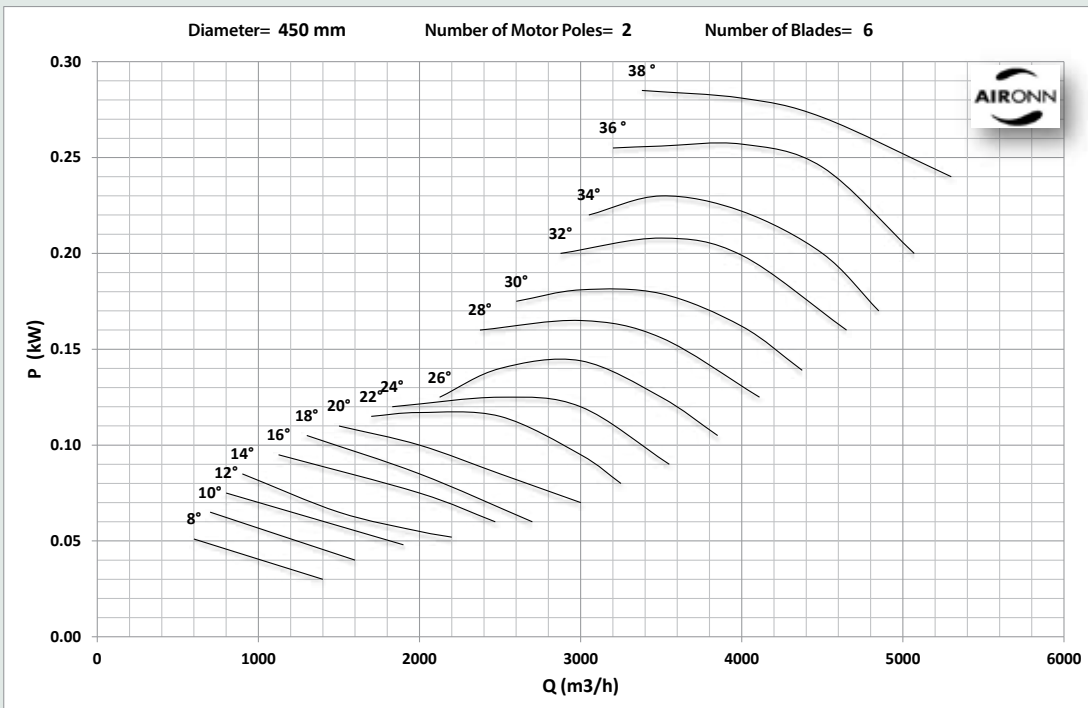
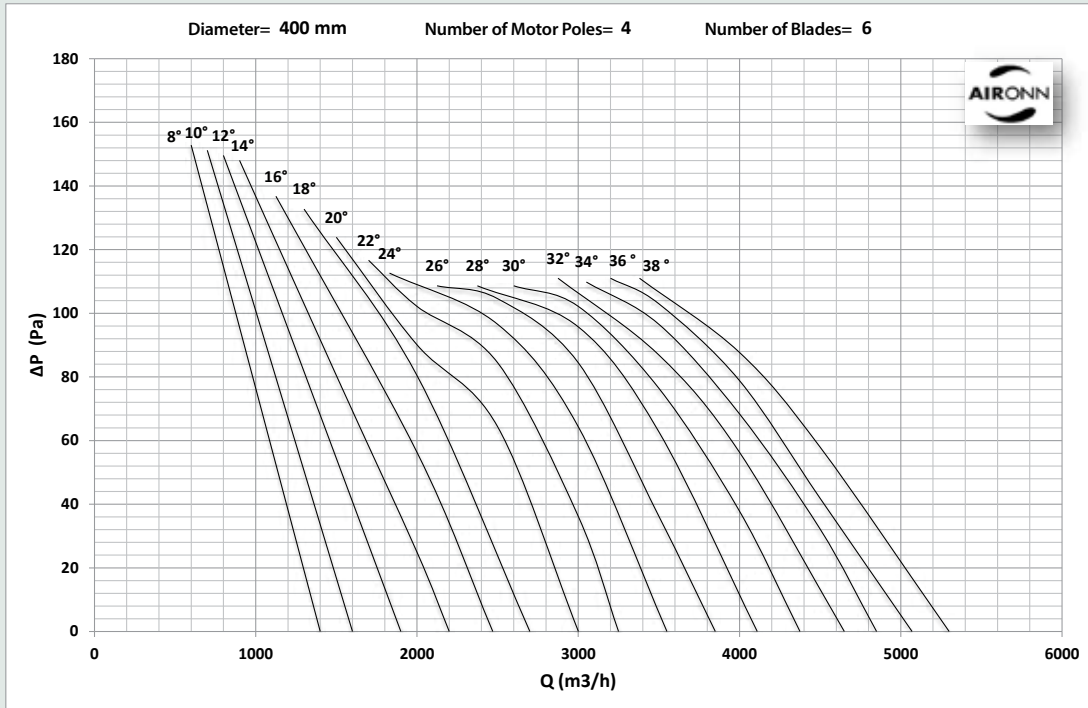

# Roof Type Axial (Vertical) Smoke Exhaust Fan Series

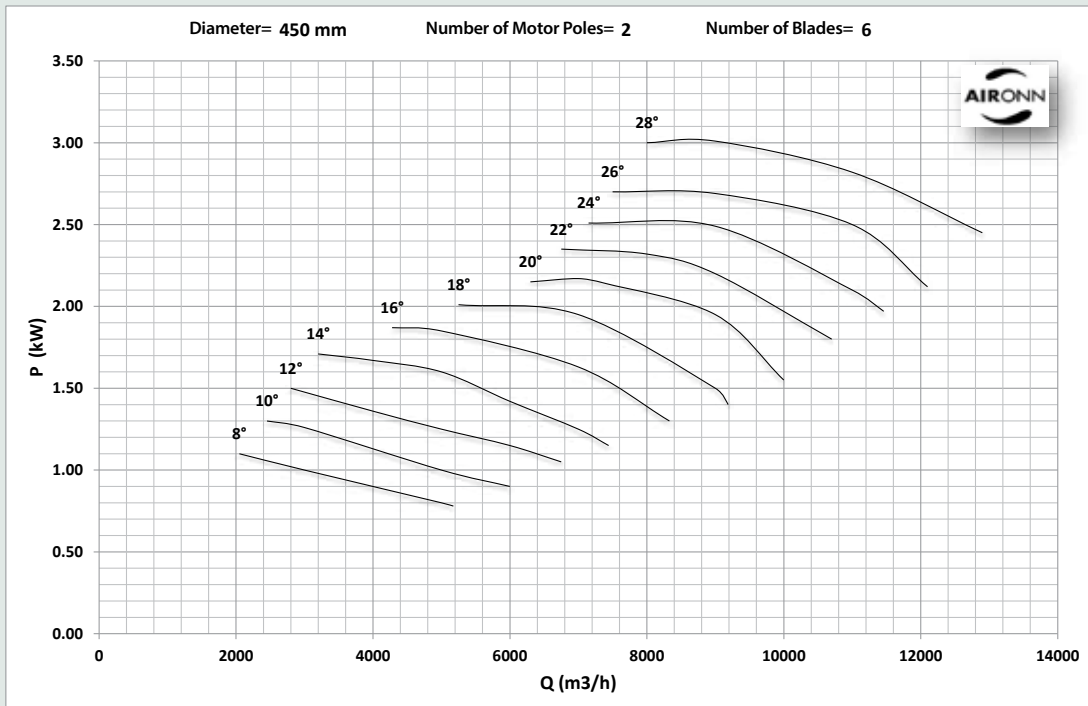
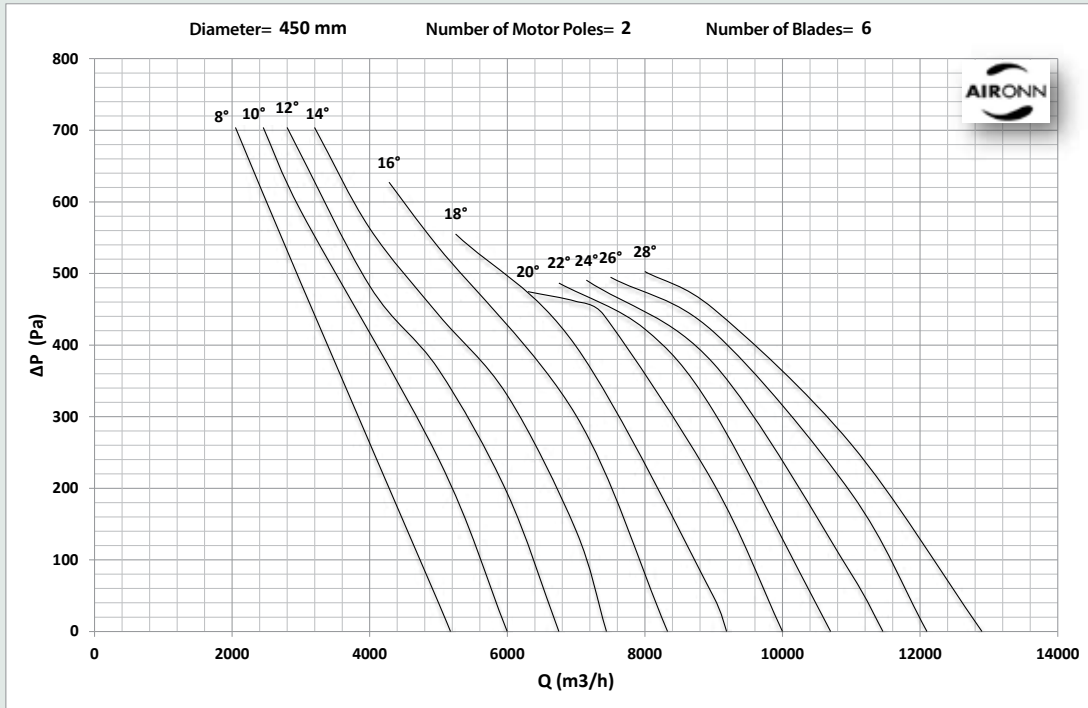

# Roof Type Axial (Vertical) Smoke Exhaust Fan Series

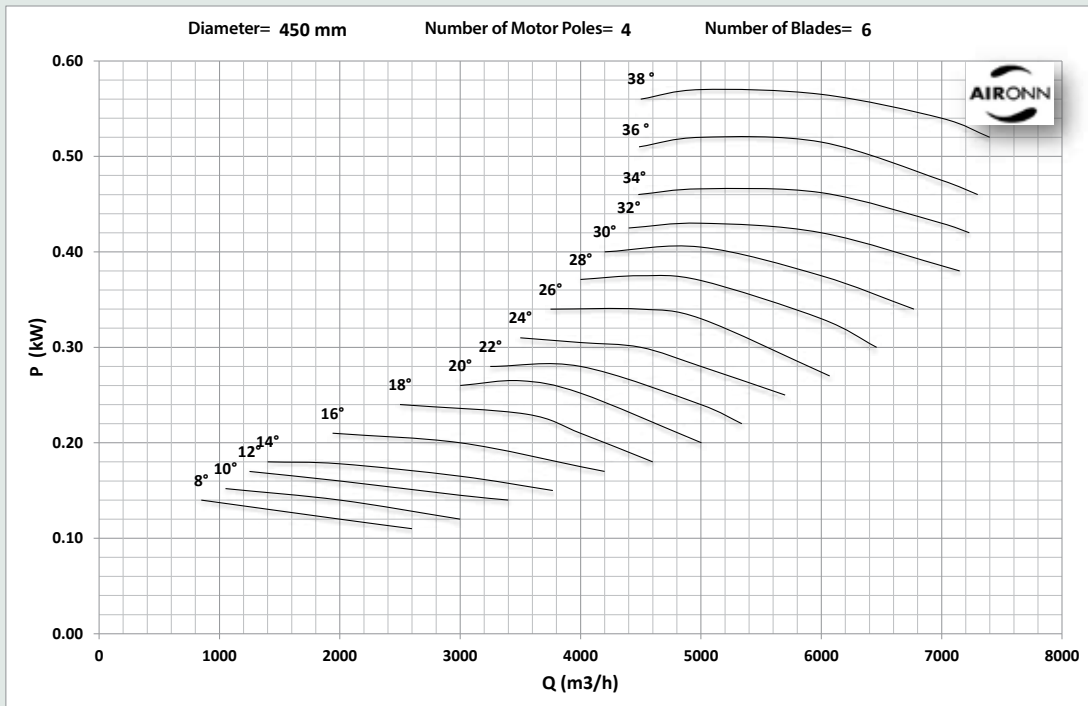
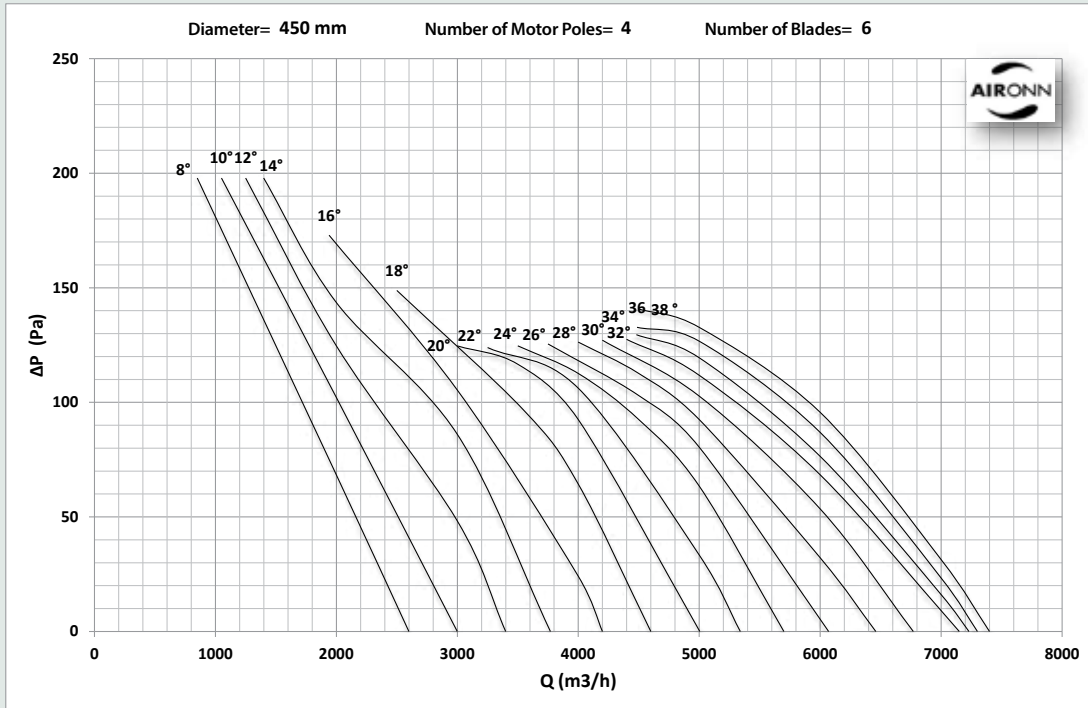



# Roof Type Axial (Vertical) Smoke Exhaust Fan Series

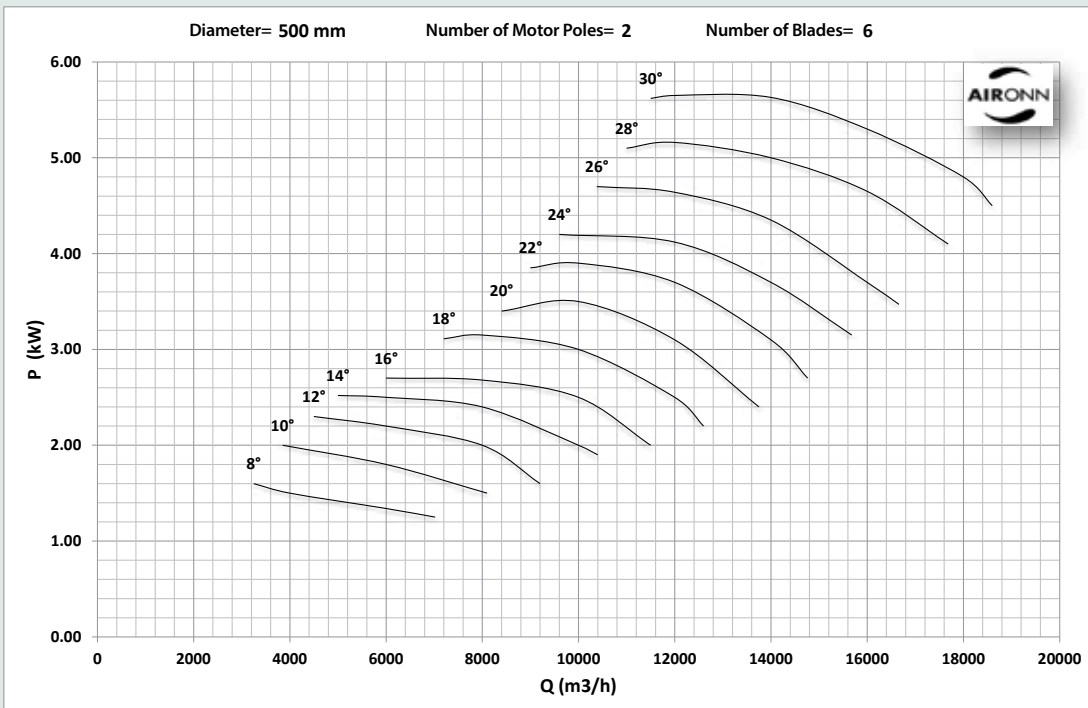
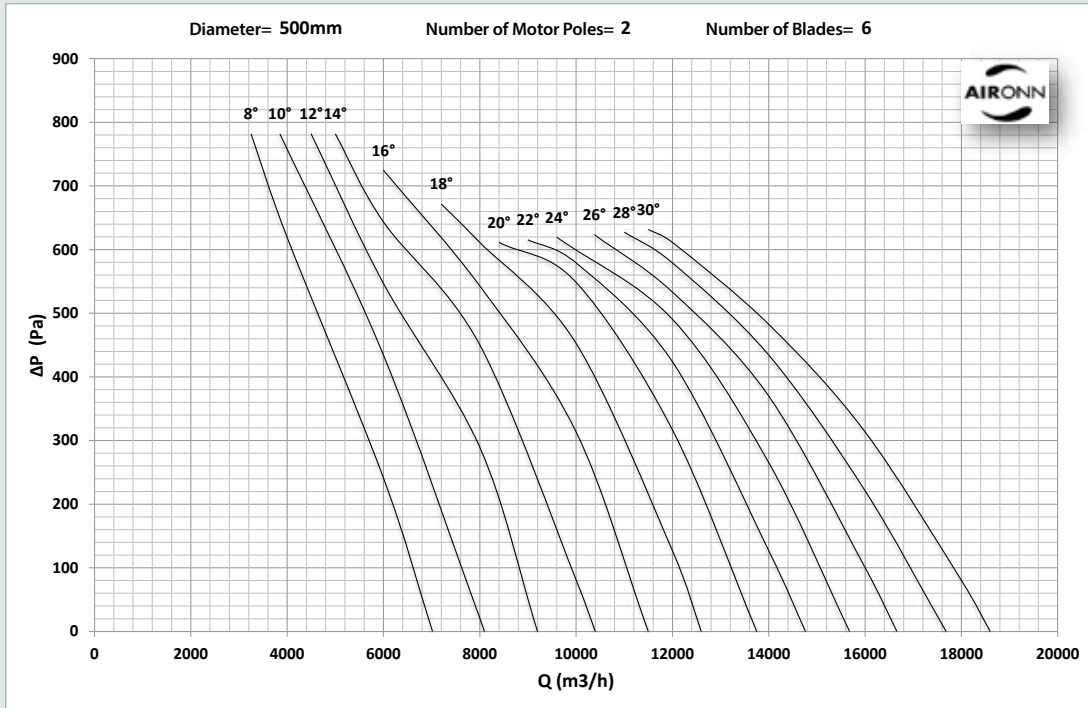

# Roof Type Axial (Vertical) Smoke Exhaust Fan Series

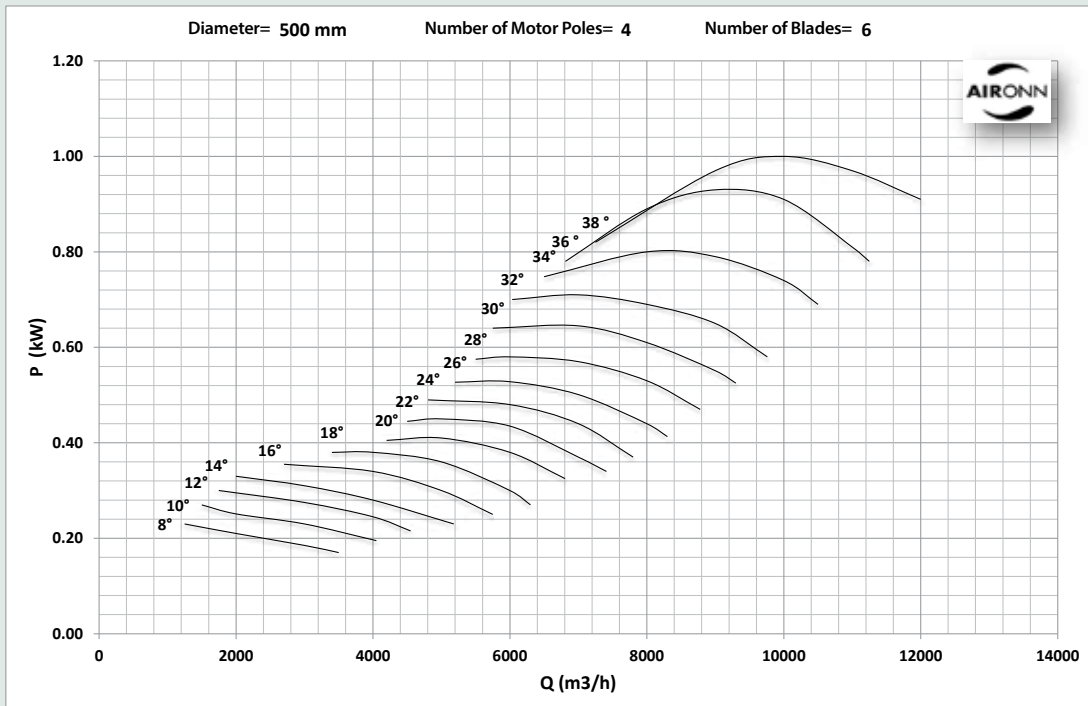
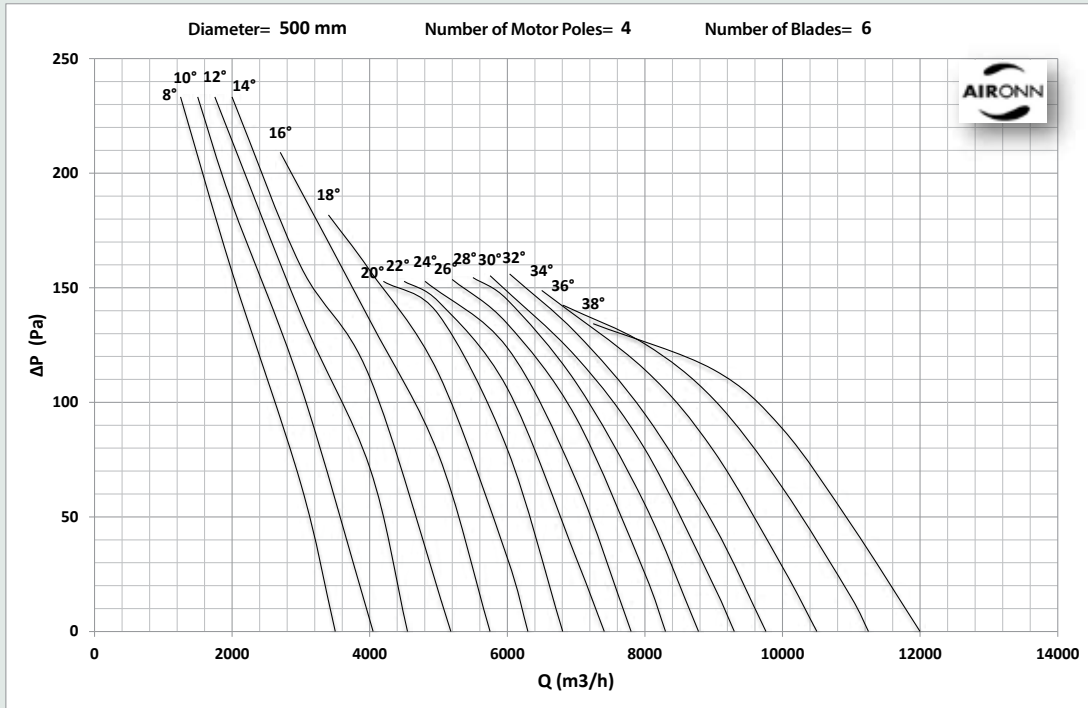

# Roof Type Axial (Vertical) Smoke Exhaust Fan Series

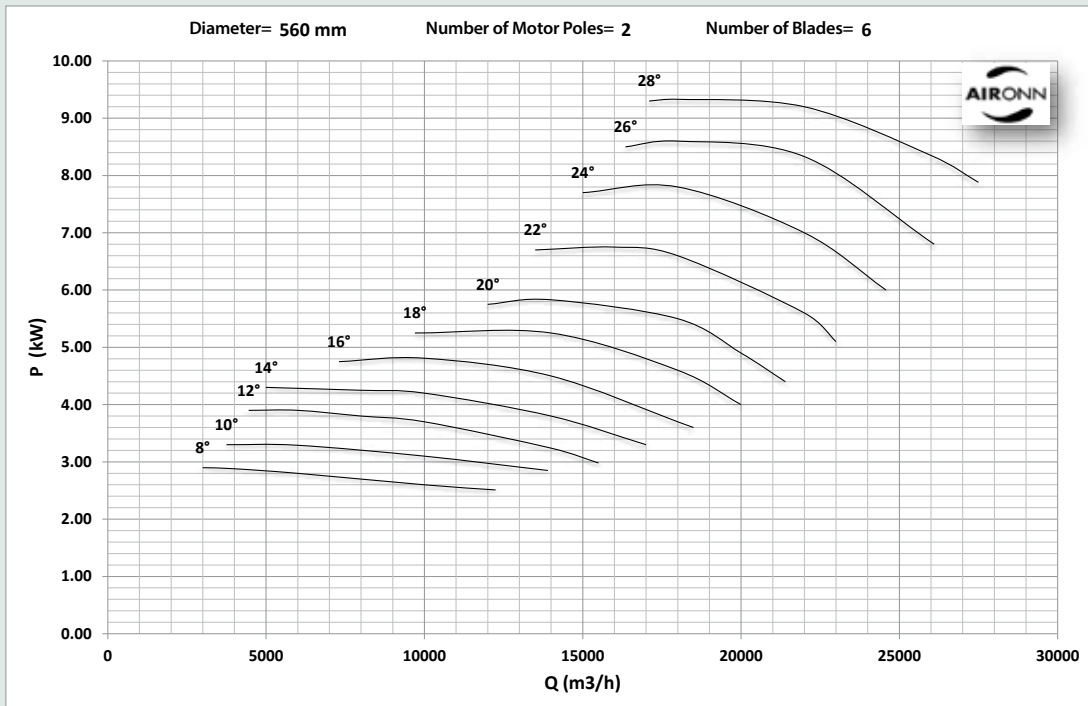
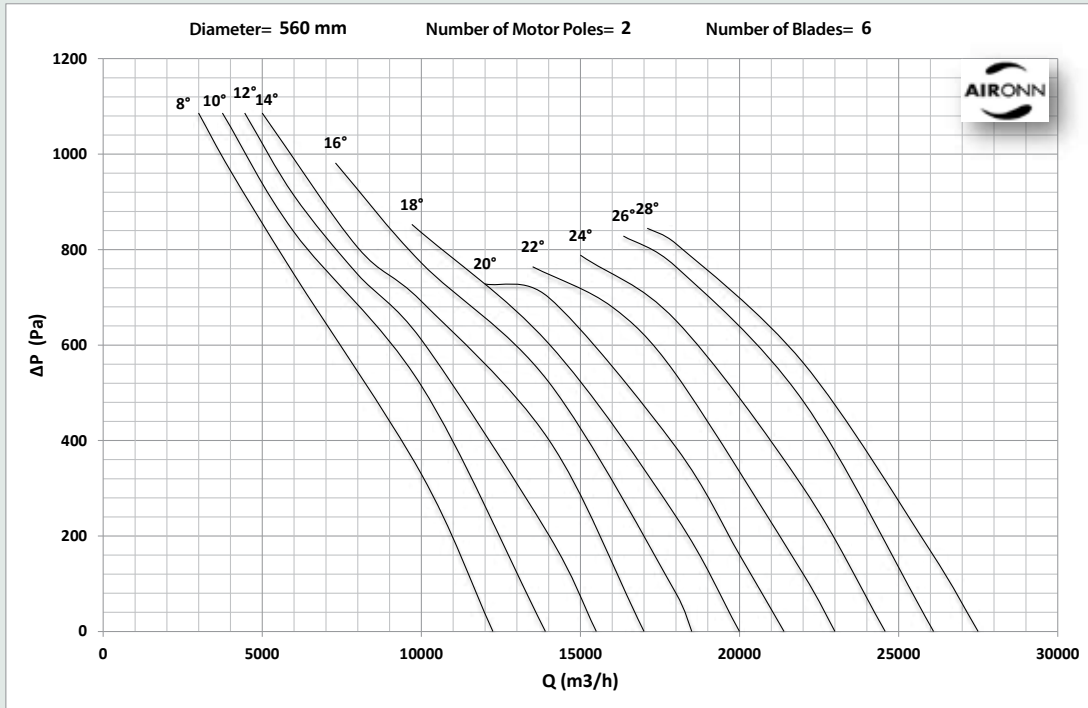

# Roof Type Axial (Vertical) Smoke Exhaust Fan Series

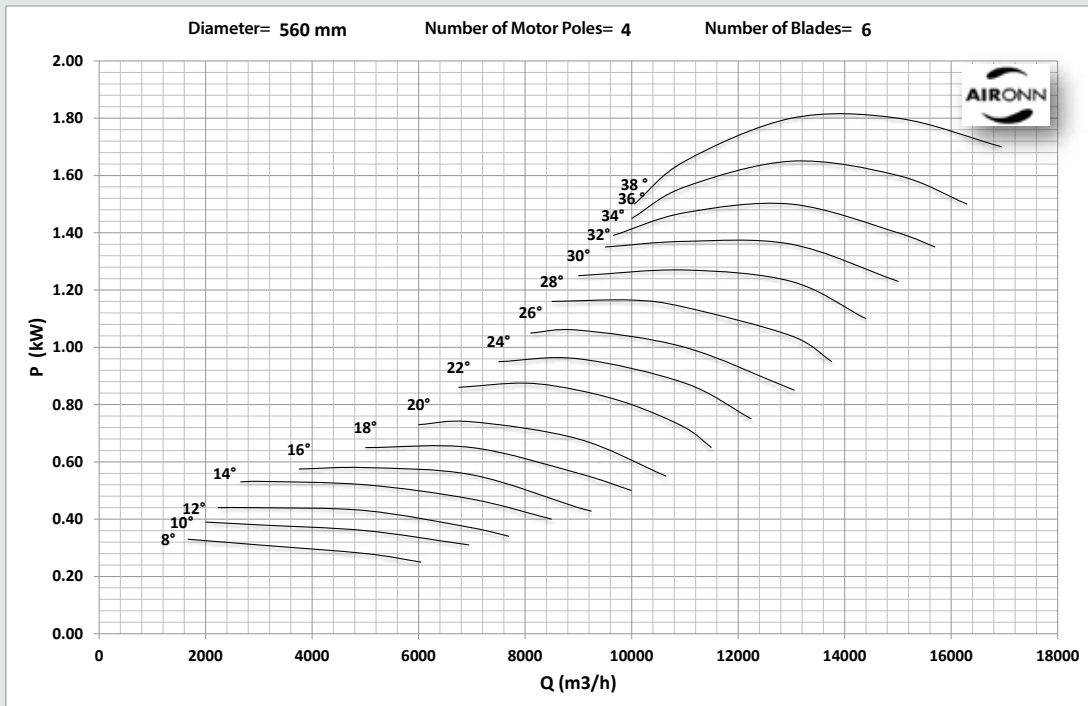
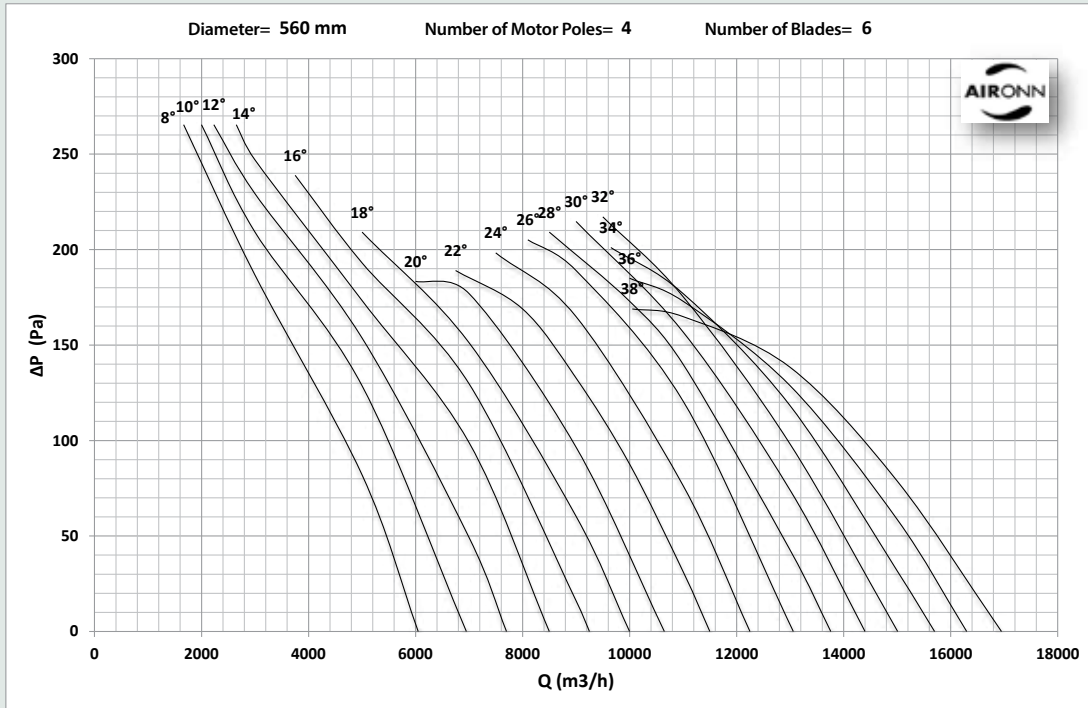

# Roof Type Axial (Vertical) Smoke Exhaust Fan Series

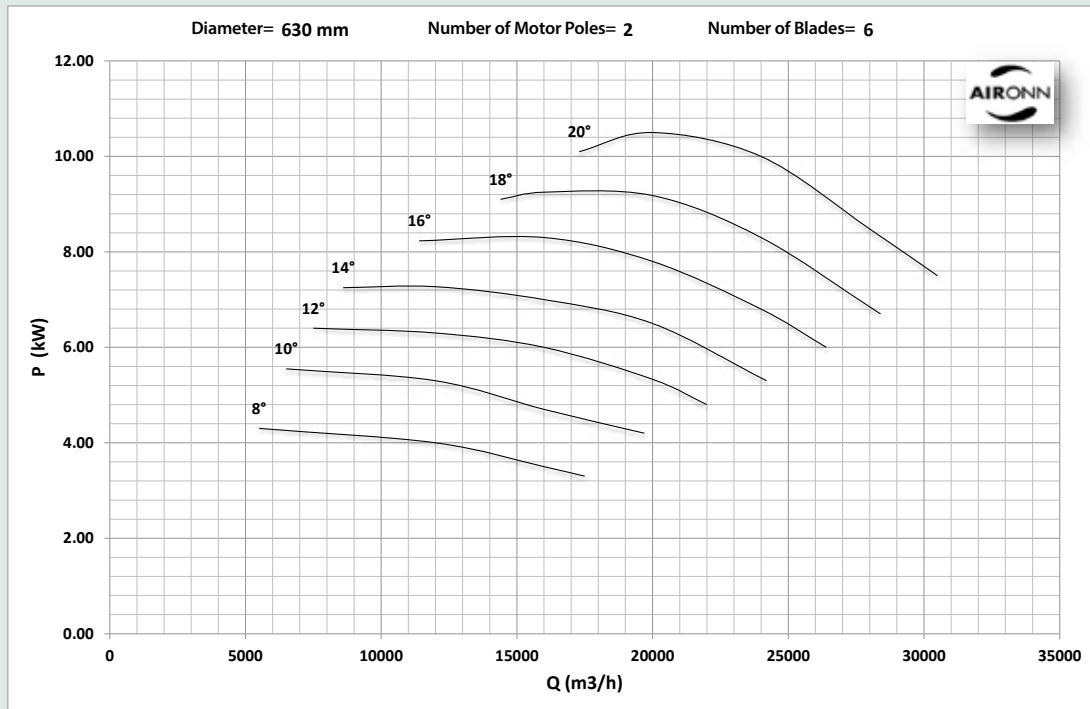
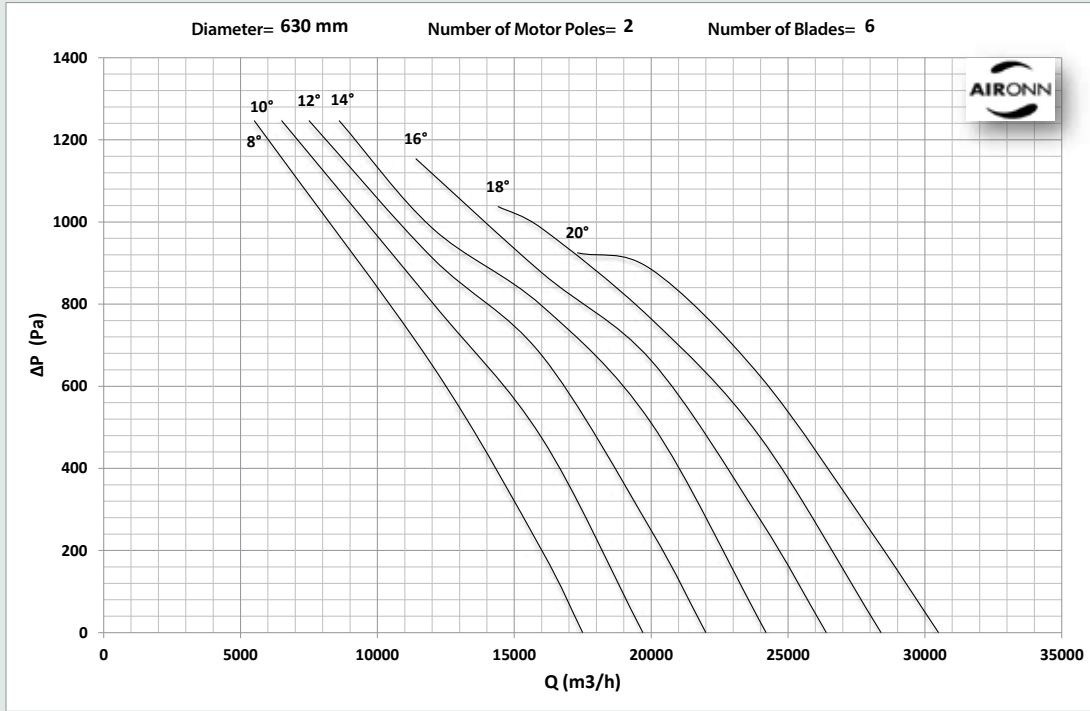

# Roof Type Axial (Vertical) Smoke Exhaust Fan Series

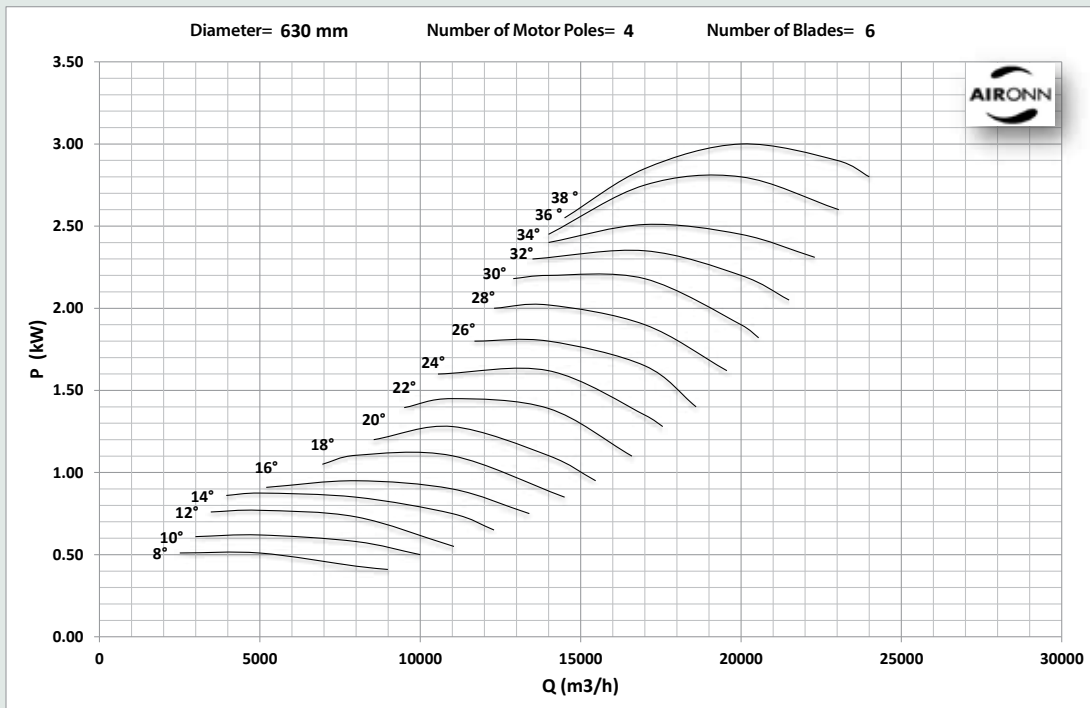
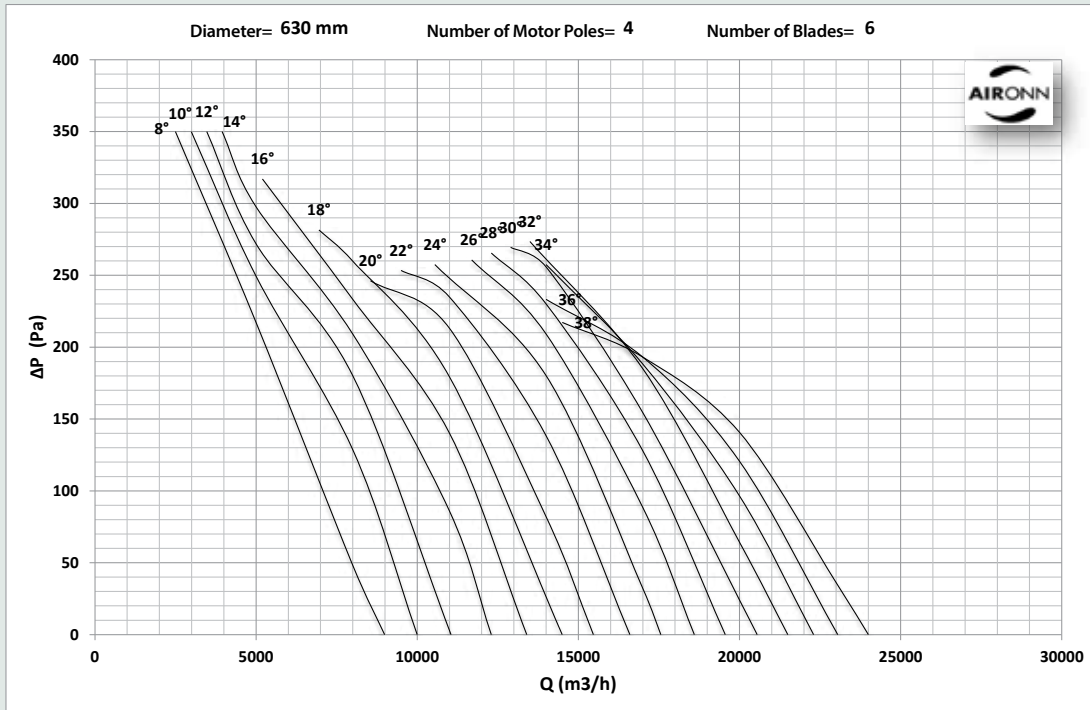

# Roof Type Axial (Vertical) Smoke Exhaust Fan Series

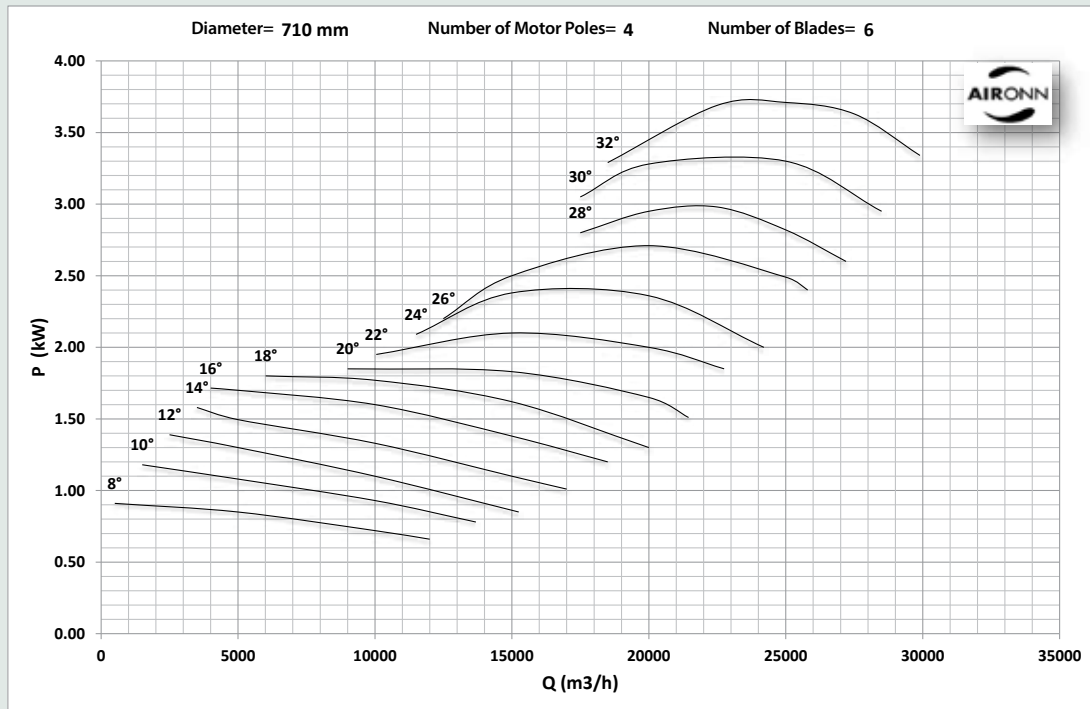
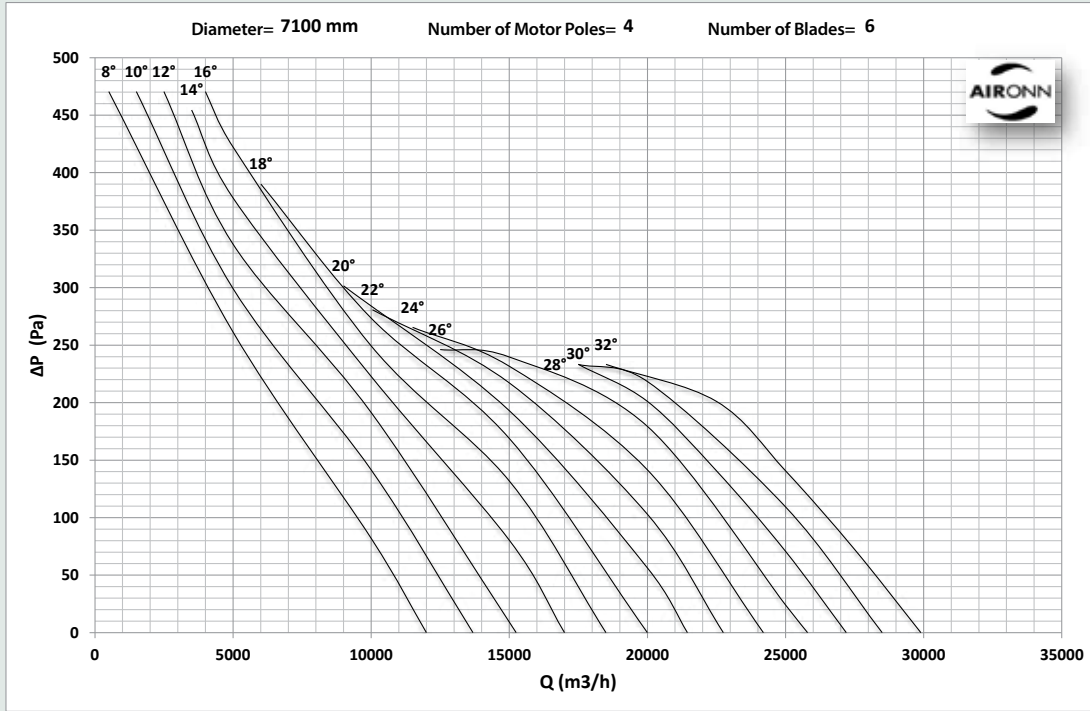

# Roof Type Axial (Vertical) Smoke Exhaust Fan Series

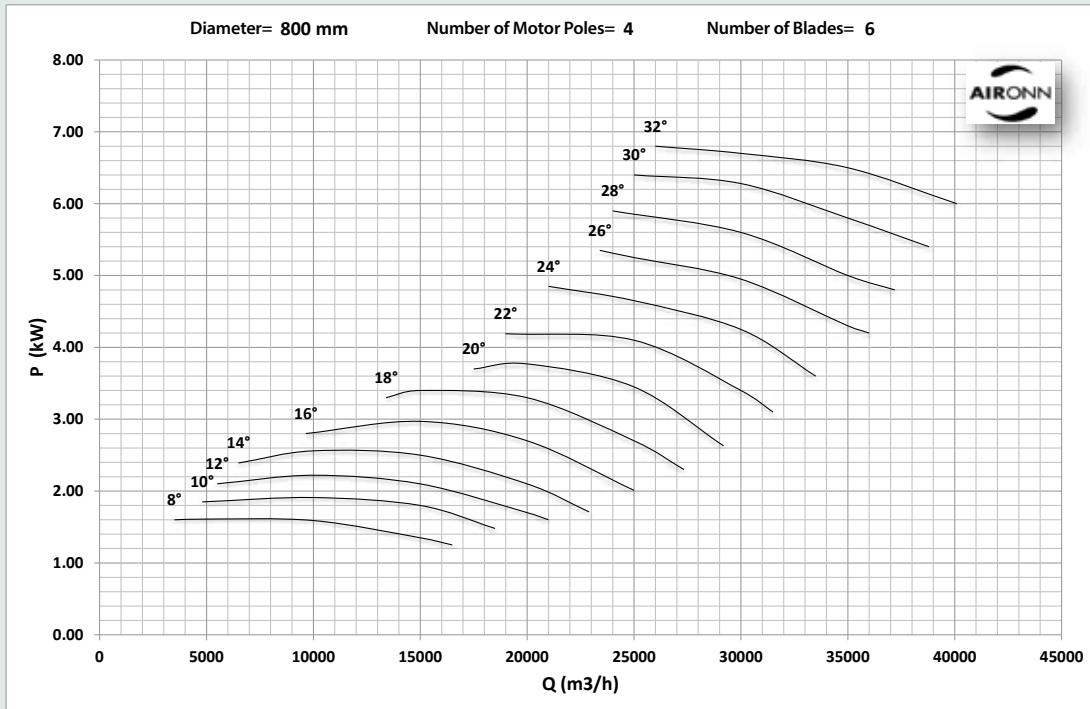
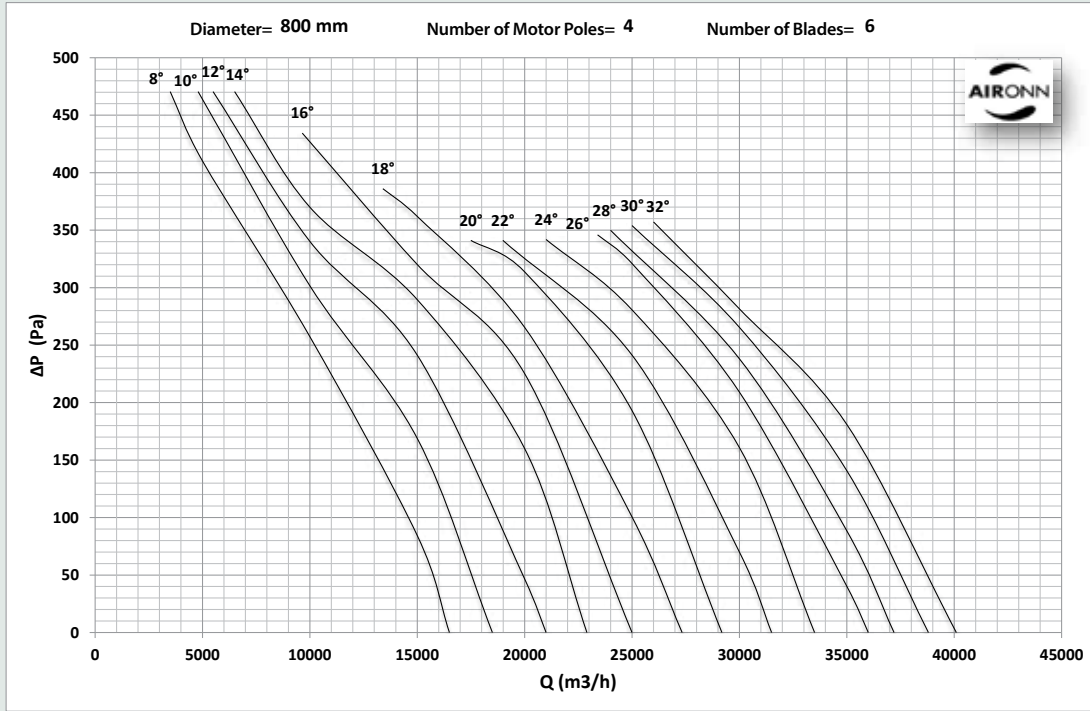



# Roof Type Axial (Vertical) Smoke Exhaust Fan Series

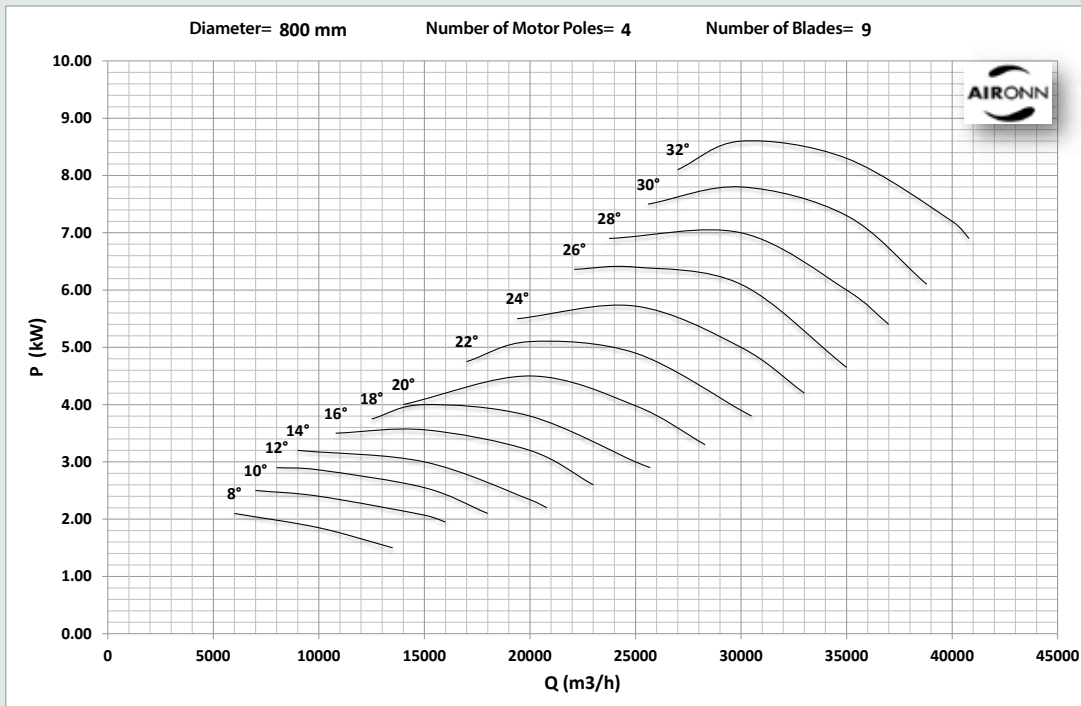
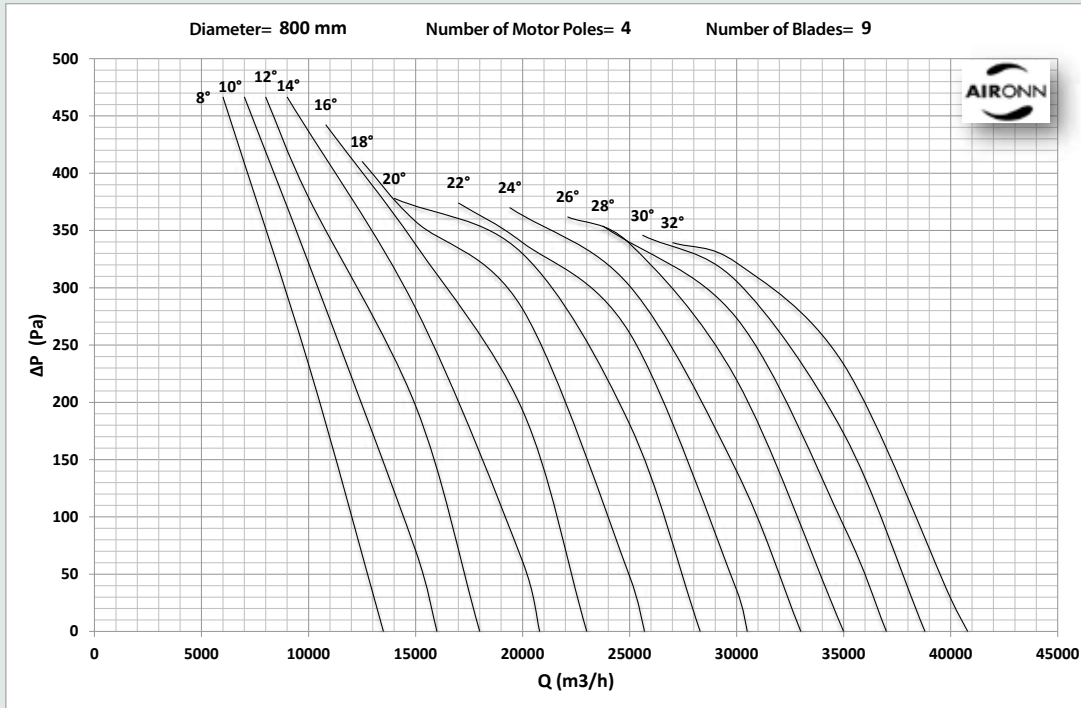

# Roof Type Axial (Vertical) Smoke Exhaust Fan Series

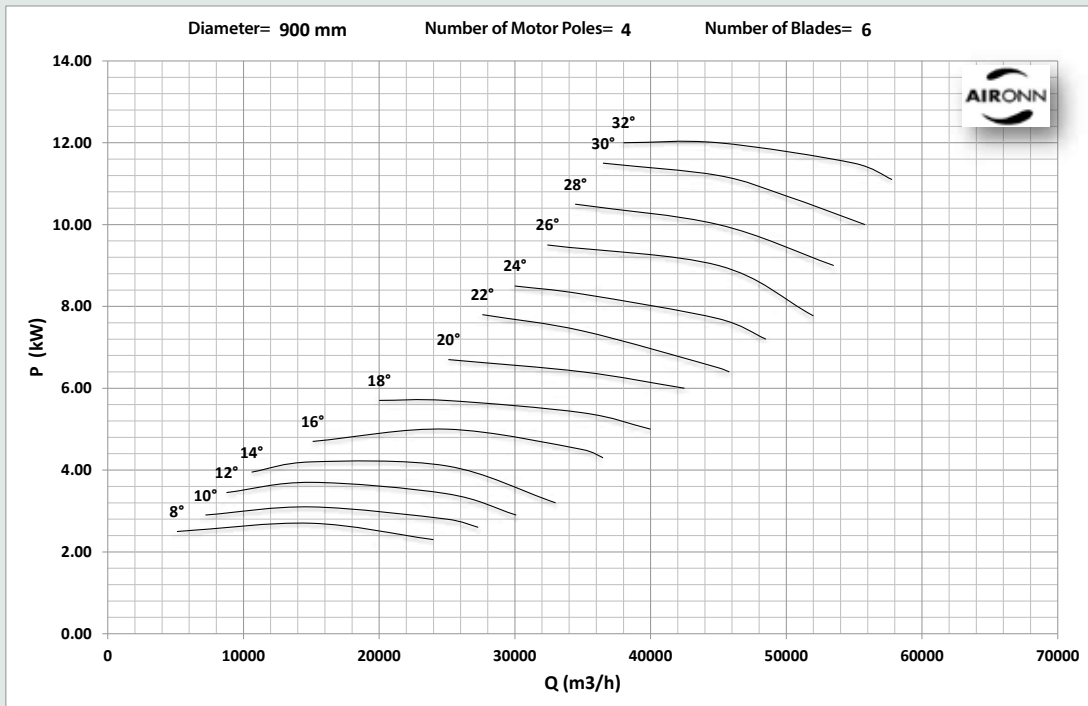
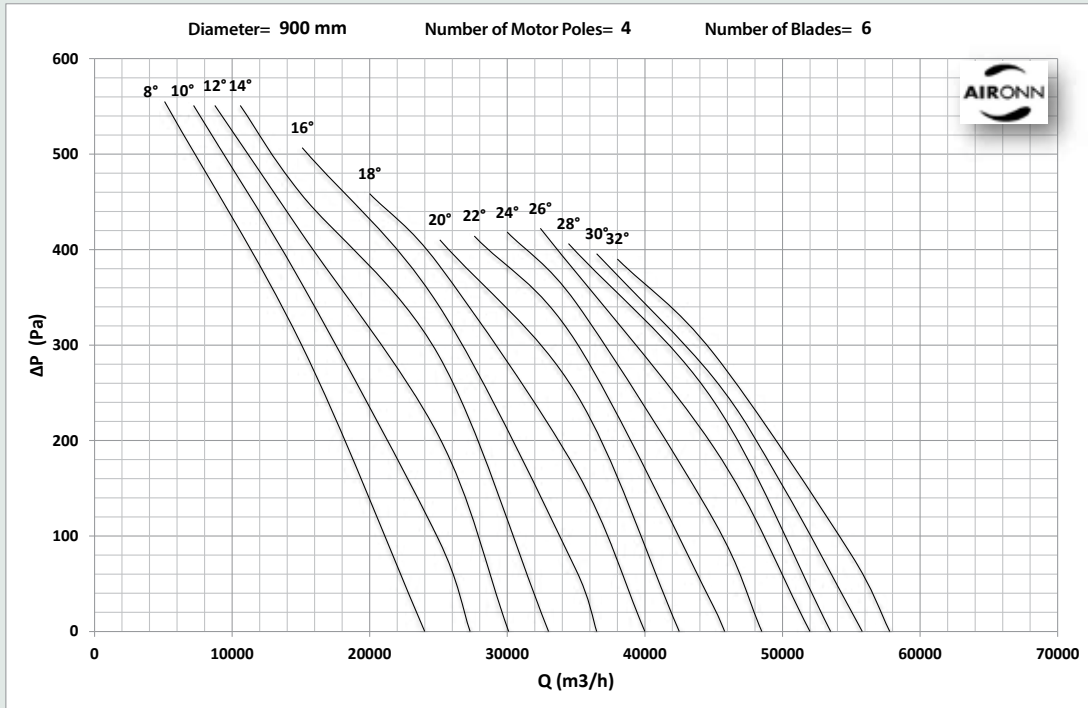

# Roof Type Axial (Vertical) Smoke Exhaust Fan Series

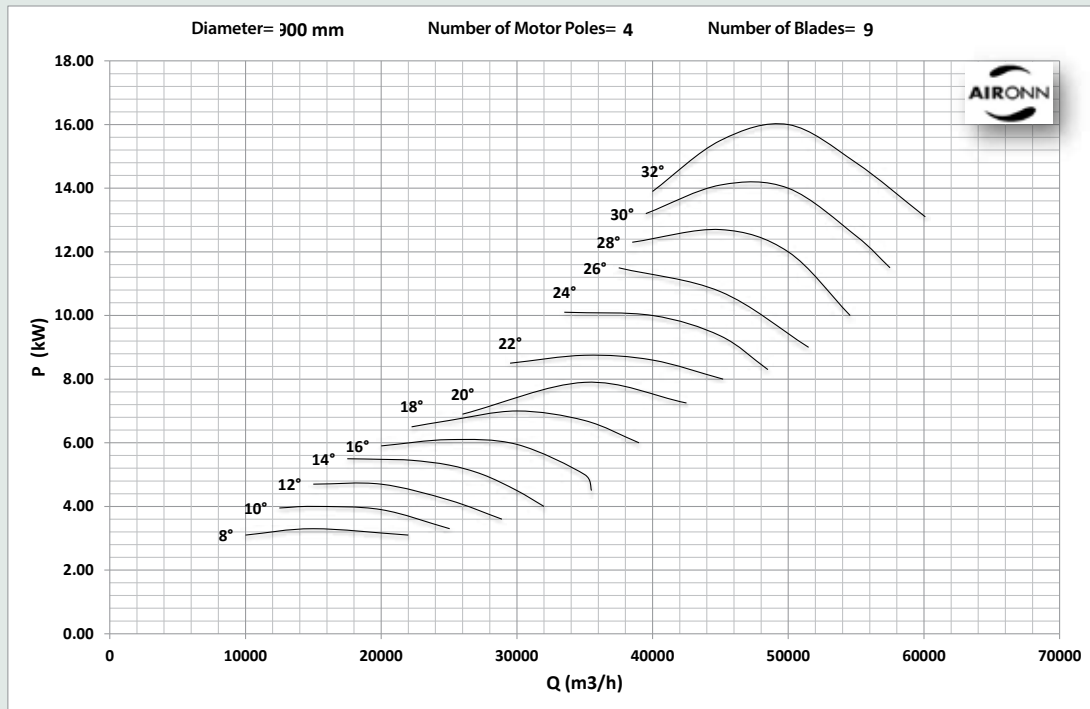
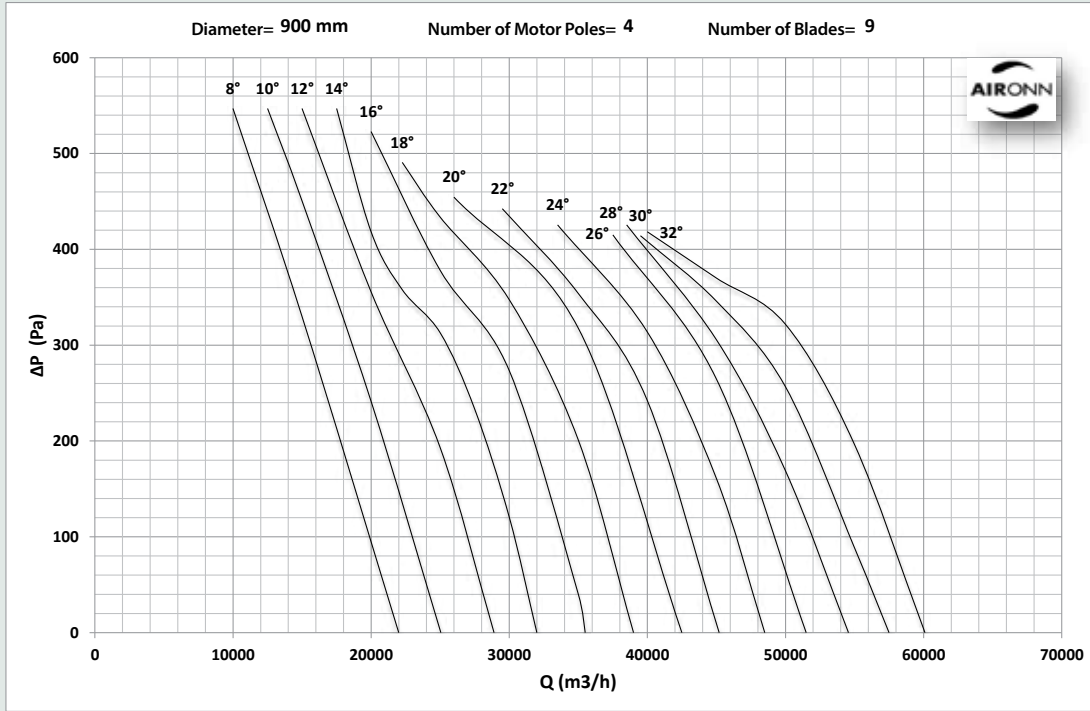

# Roof Type Axial (Vertical) Smoke Exhaust Fan Series

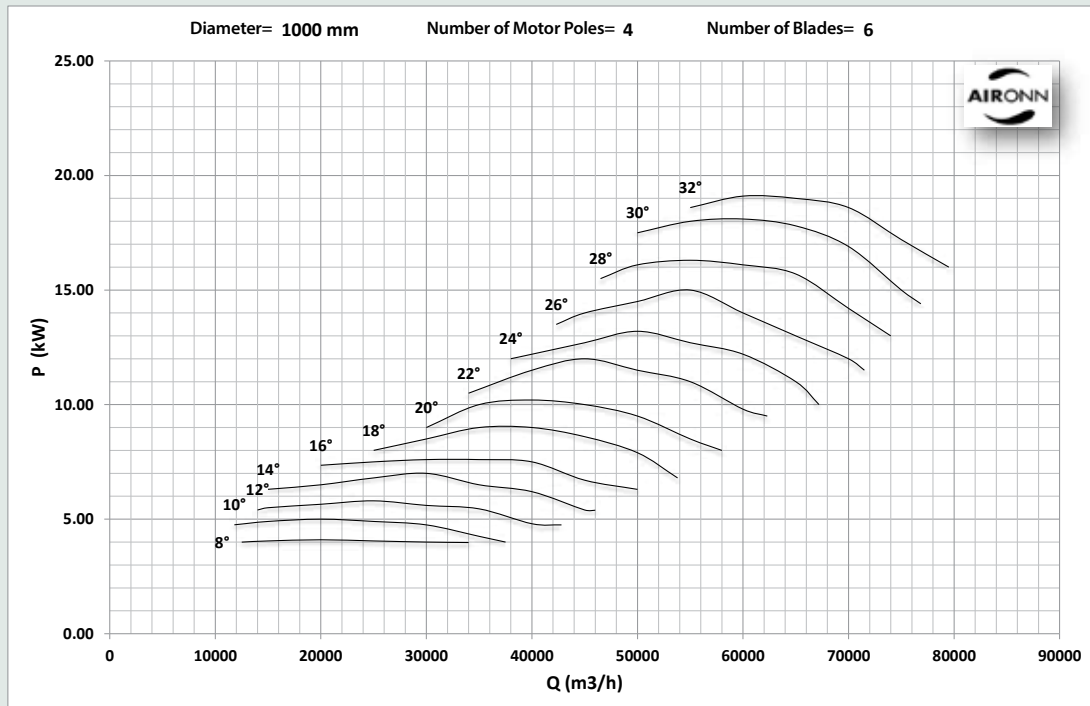
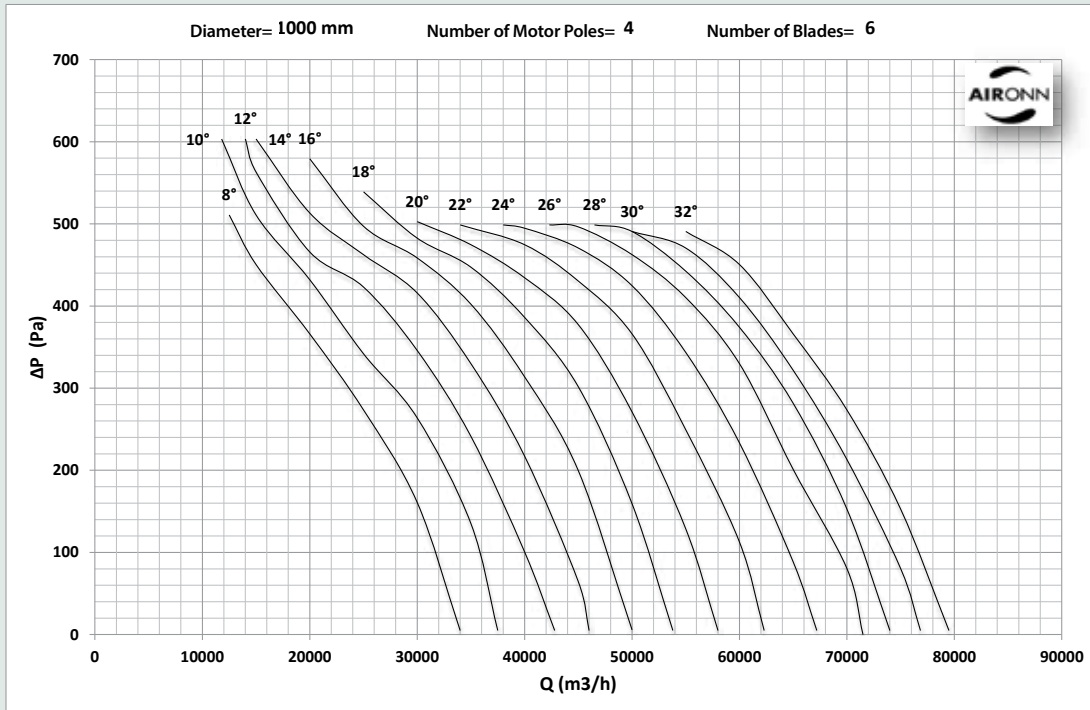

# Roof Type Axial (Vertical) Smoke Exhaust Fan Series

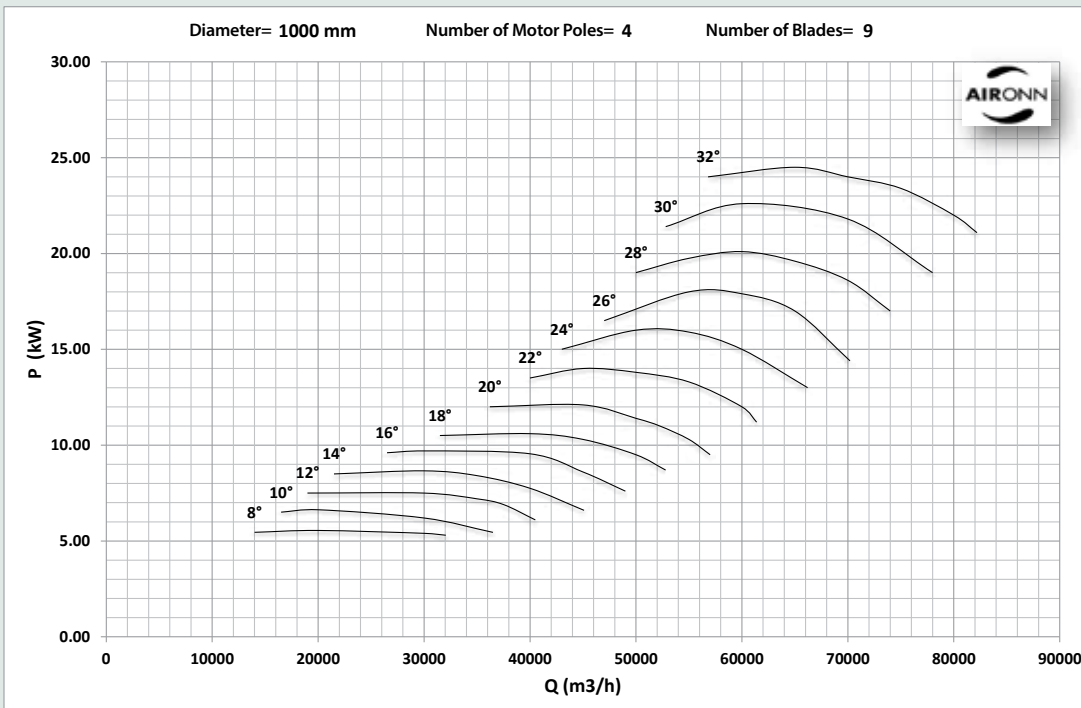
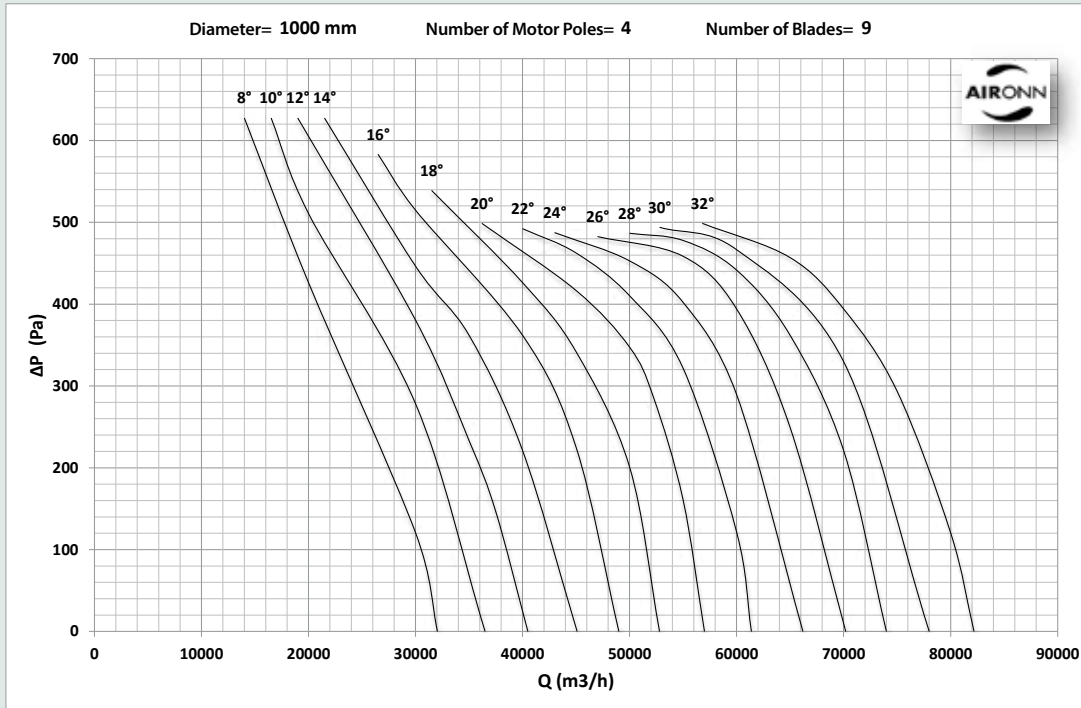

# Roof Type Axial (Vertical) Smoke Exhaust Fan Series

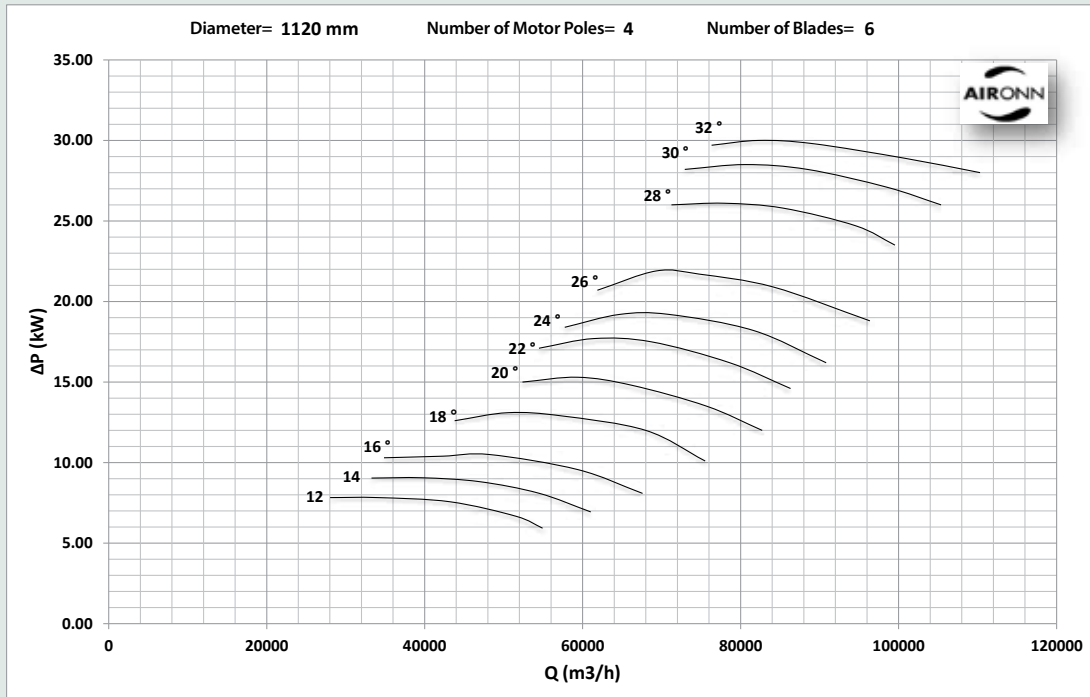
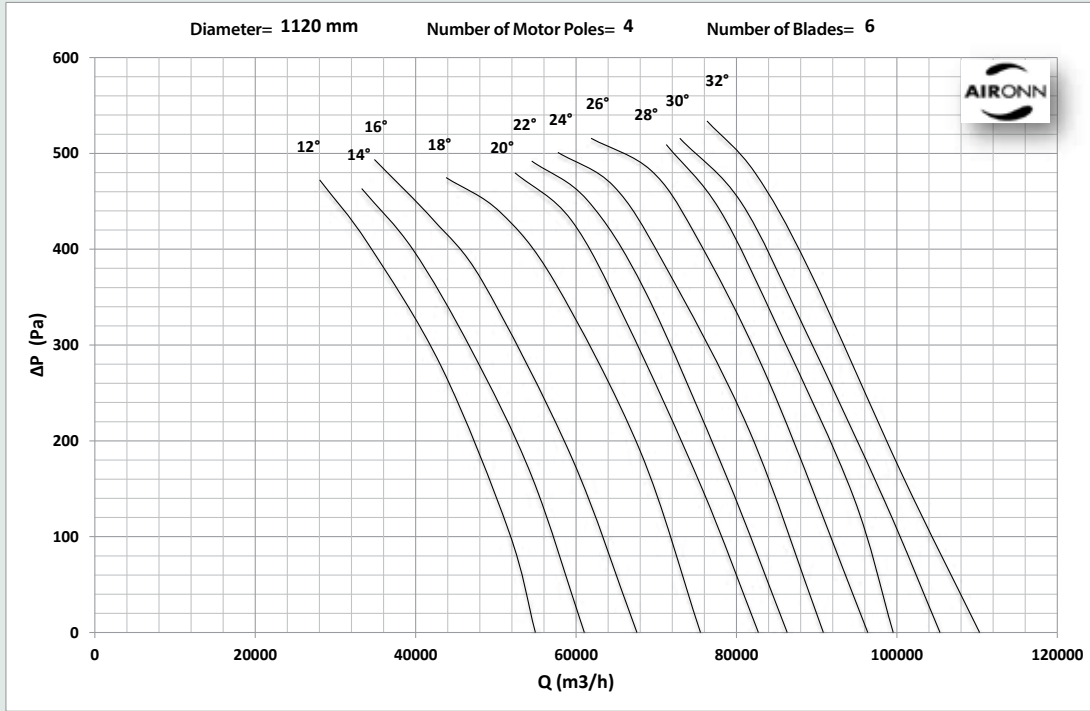

# Roof Type Axial (Vertical) Smoke Exhaust Fan Series

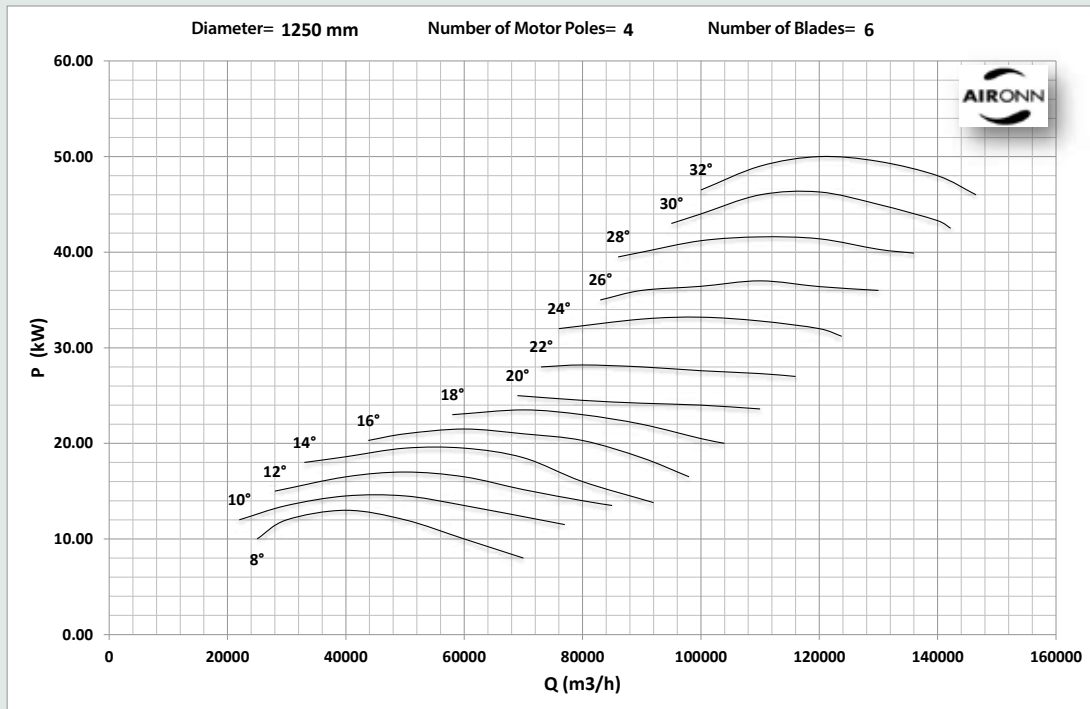
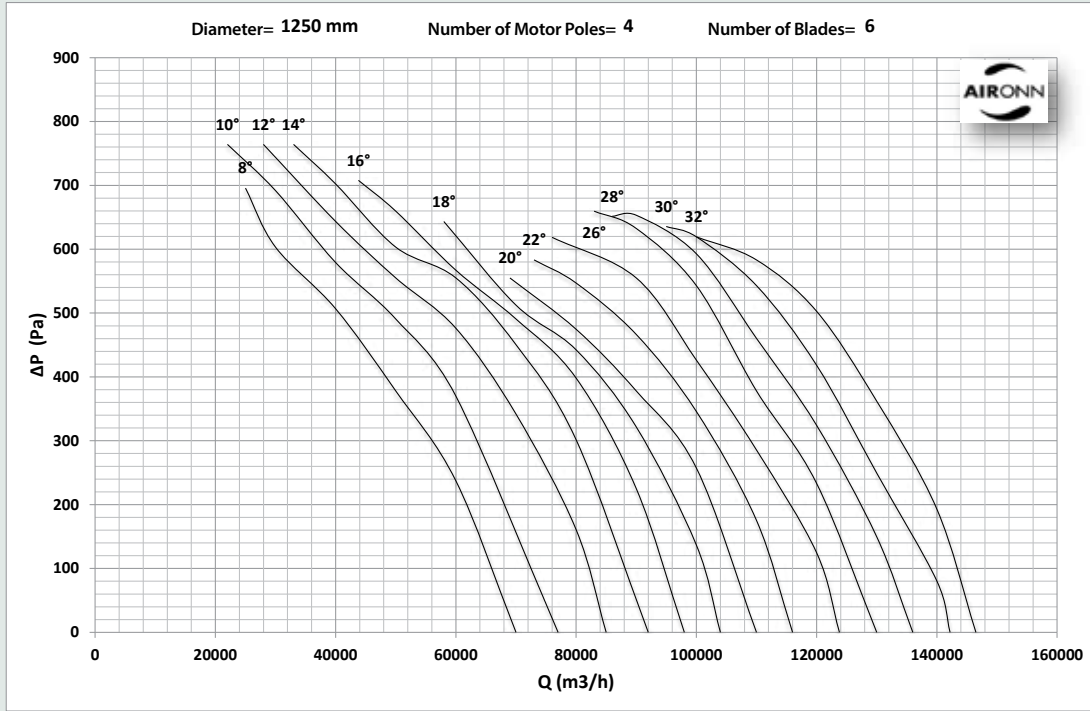

# Roof Type Axial (Vertical) Smoke Exhaust Fan Series

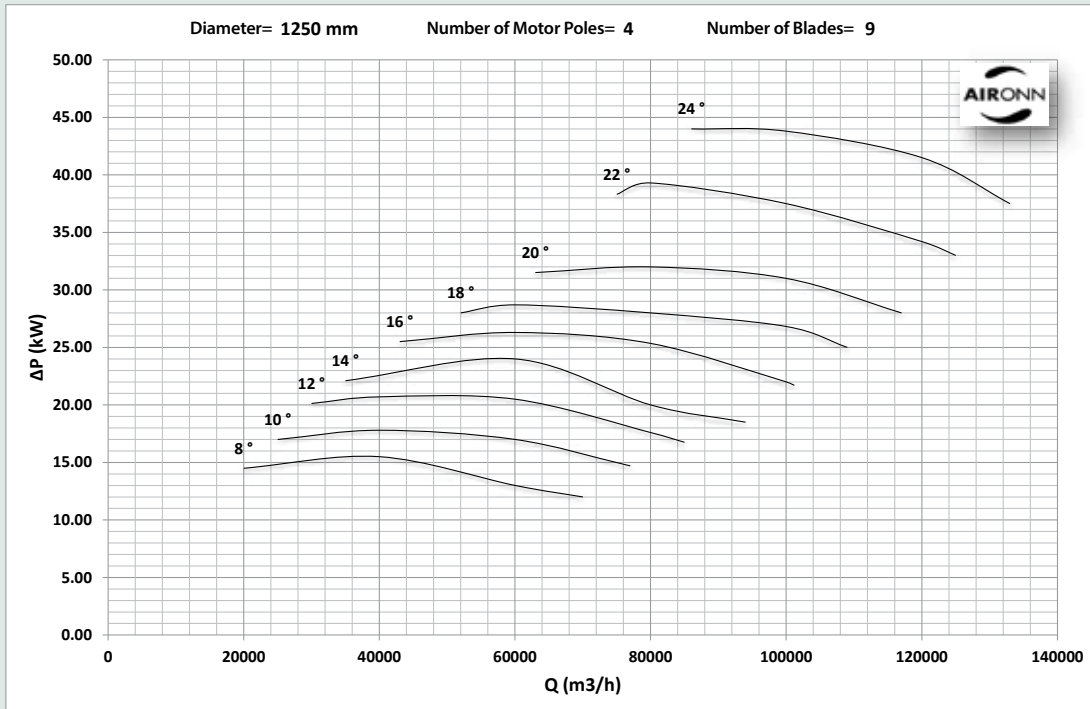
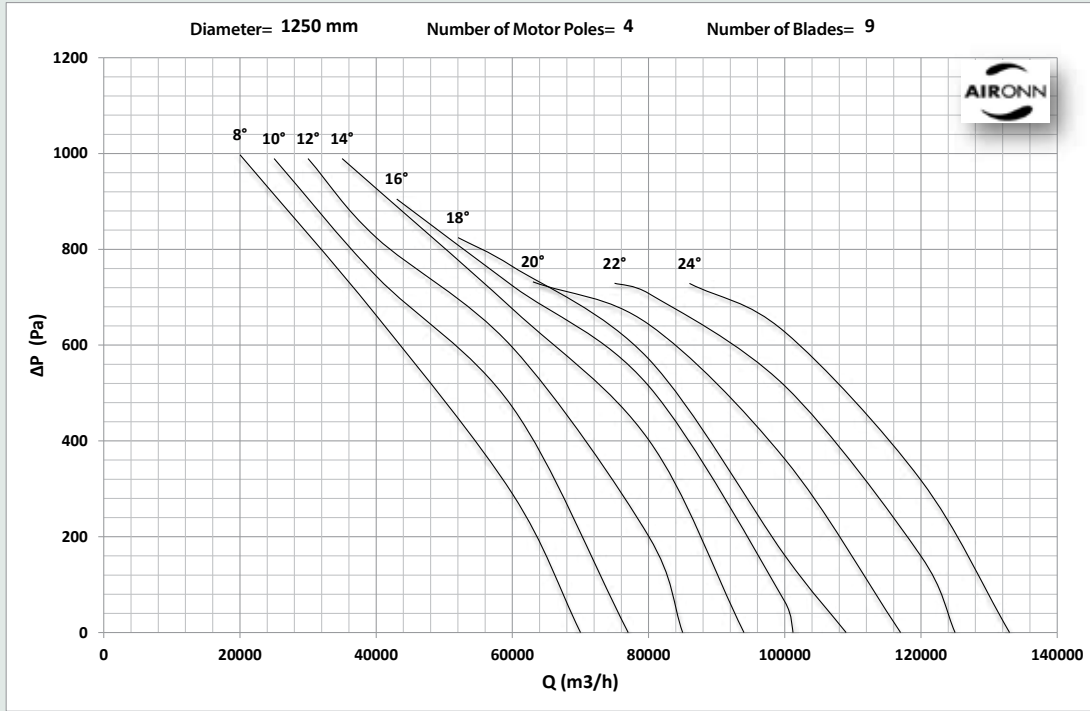



# Roof Type Axial (Vertical) Smoke Exhaust Fan Series

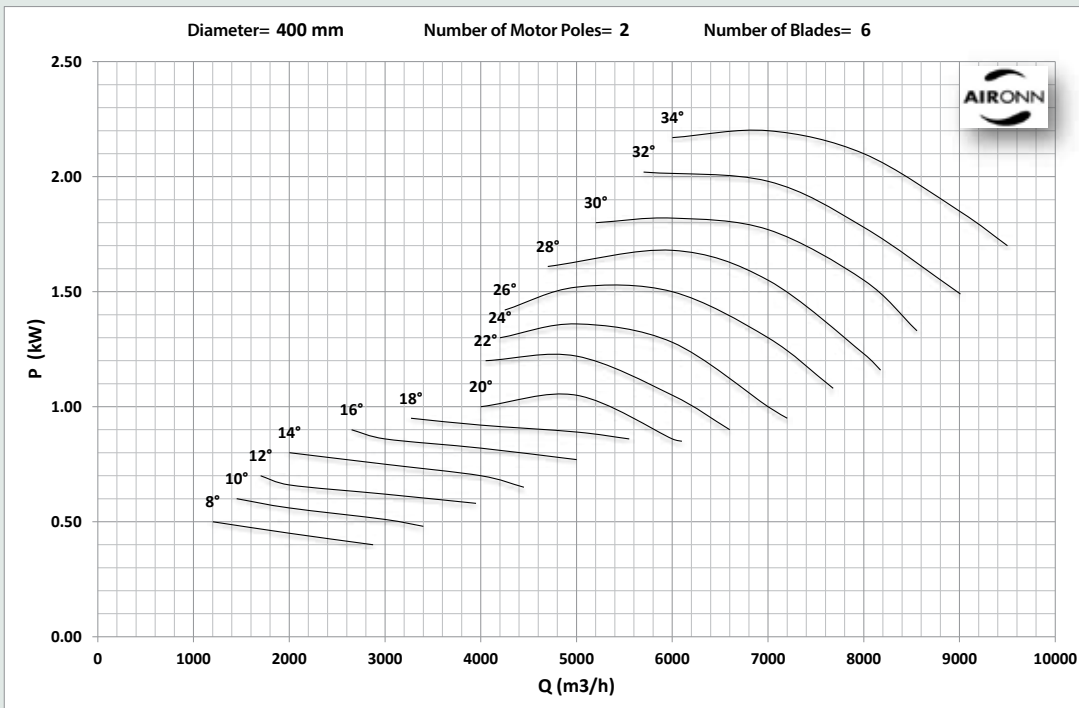
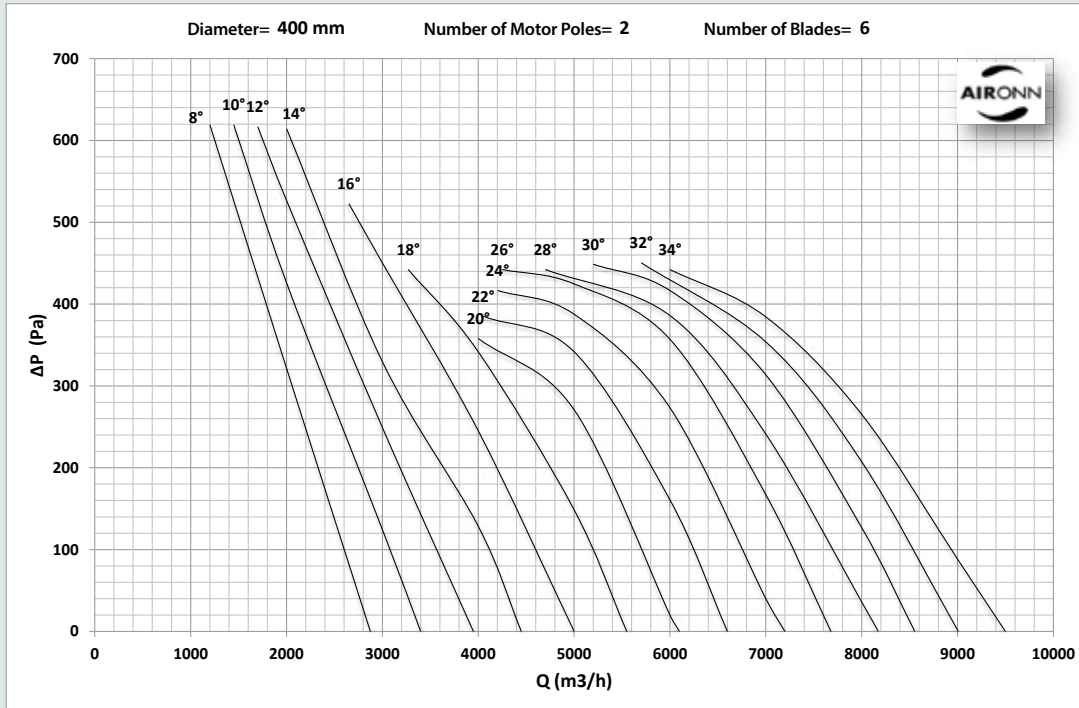

# Roof Type Axial (Vertical) Smoke Exhaust Fan Series

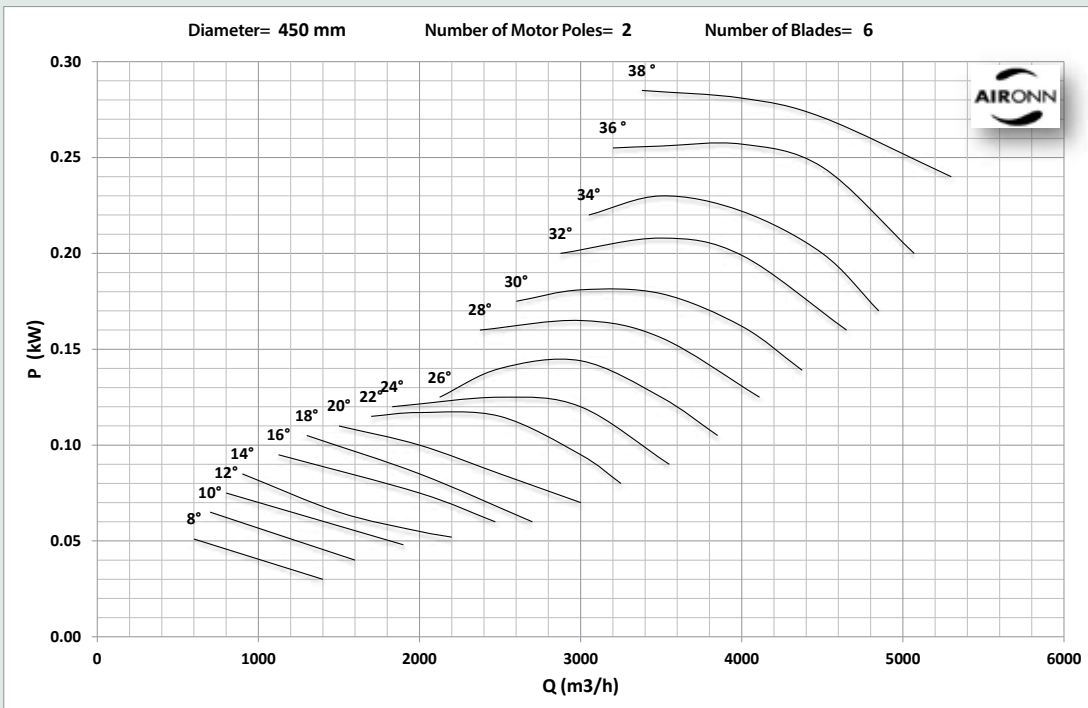
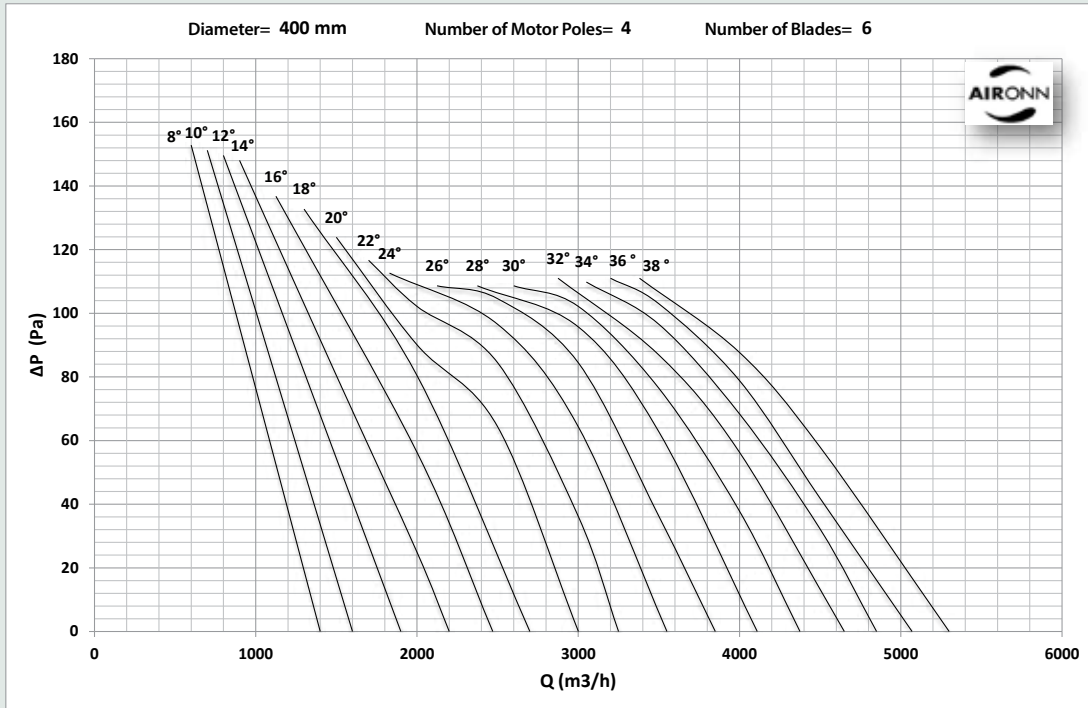

# Roof Type Axial (Vertical) Smoke Exhaust Fan Series

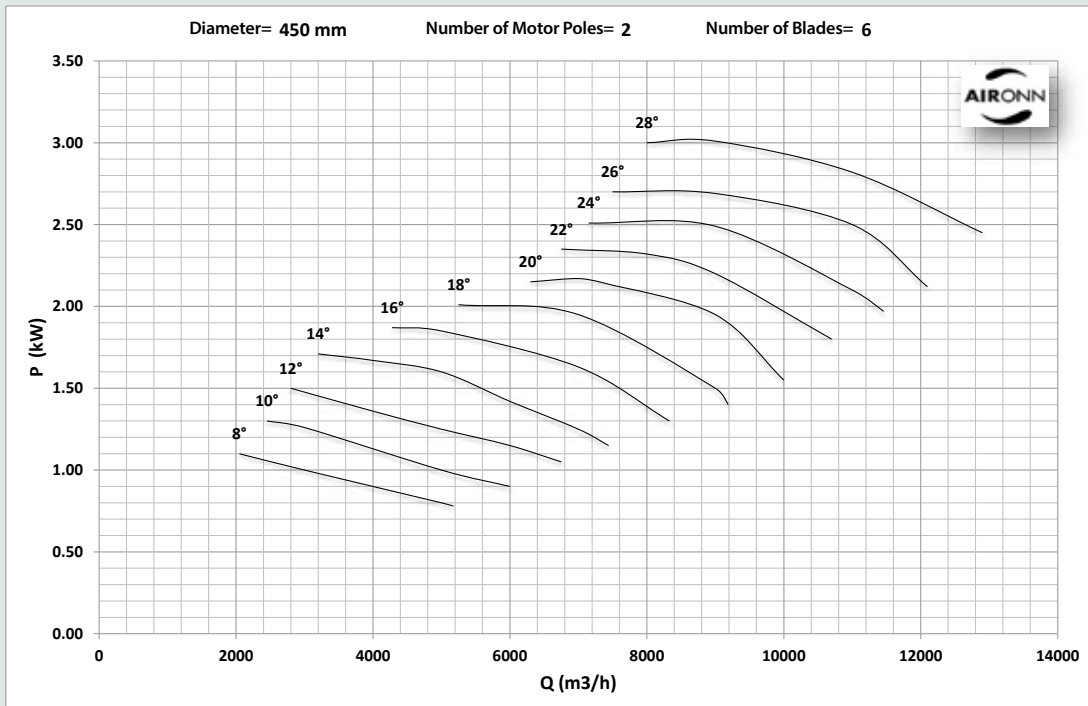
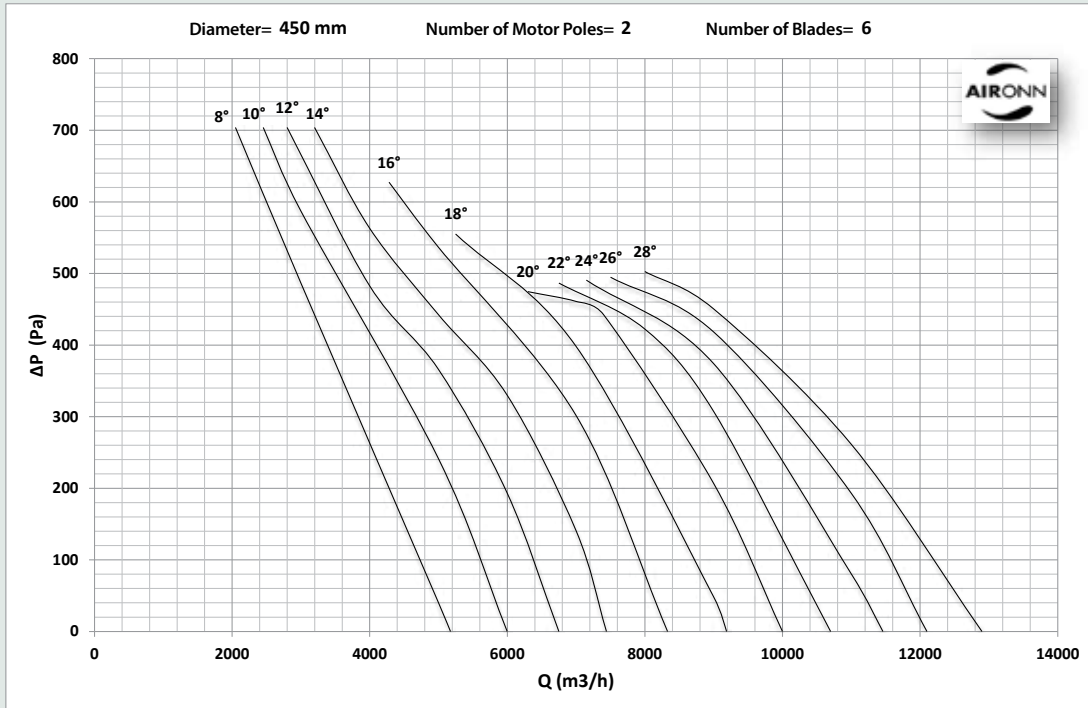

# Roof Type Axial (Vertical) Smoke Exhaust Fan Series

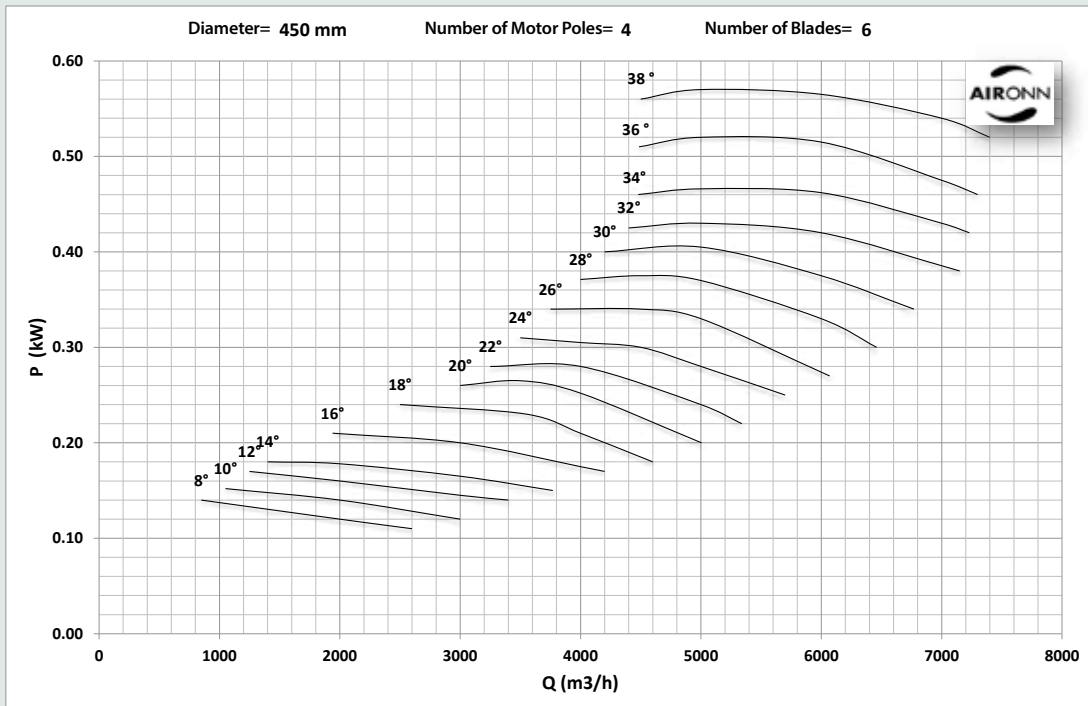
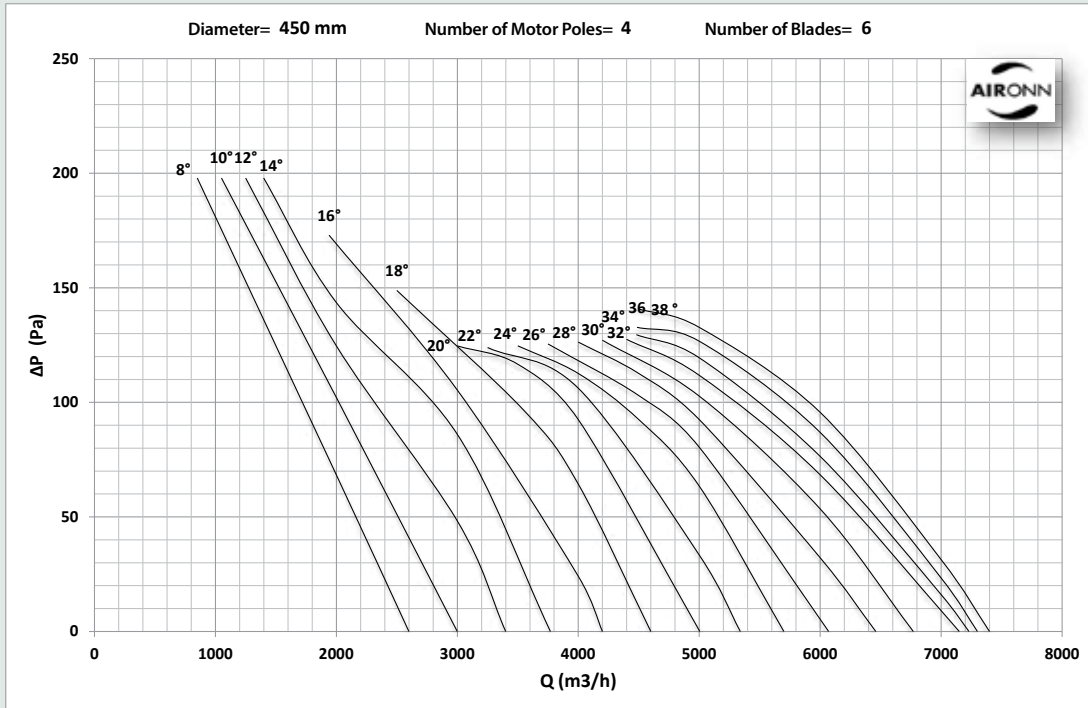

# Roof Type Axial (Vertical) Smoke Exhaust Fan Series

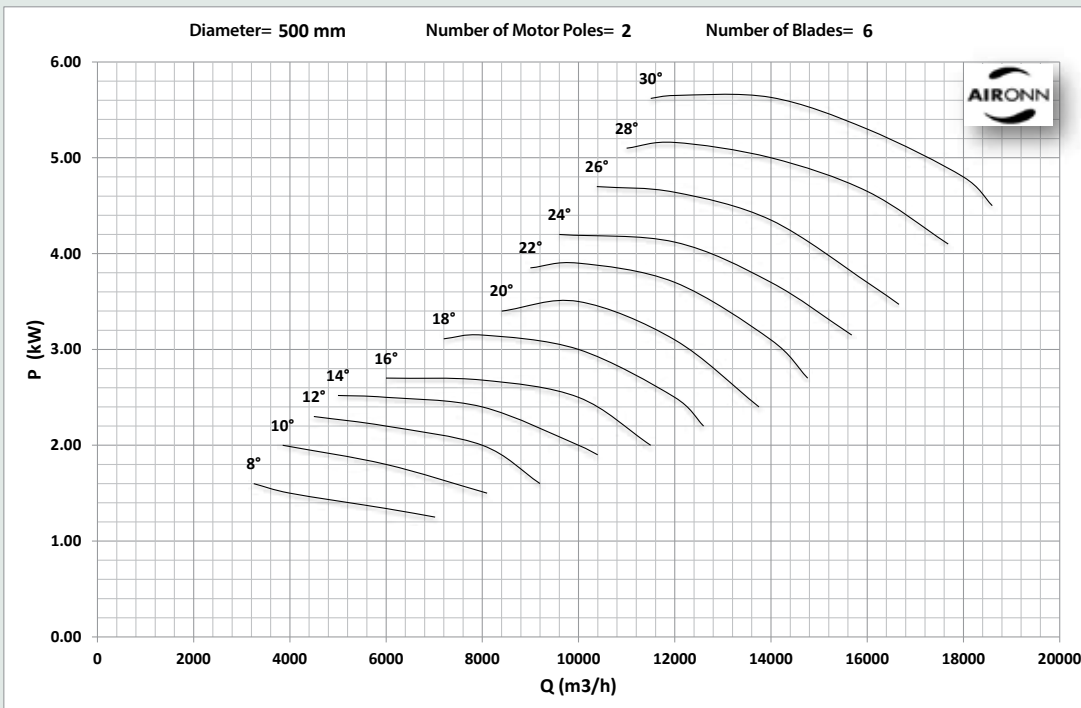
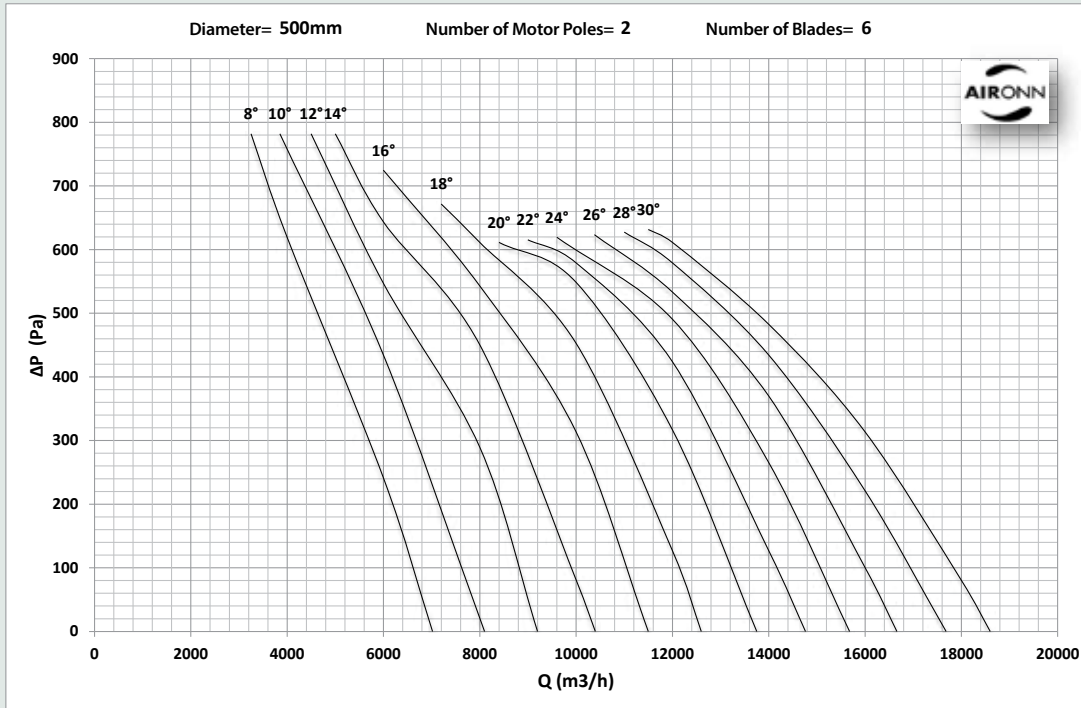

# Roof Type Axial (Vertical) Smoke Exhaust Fan Series

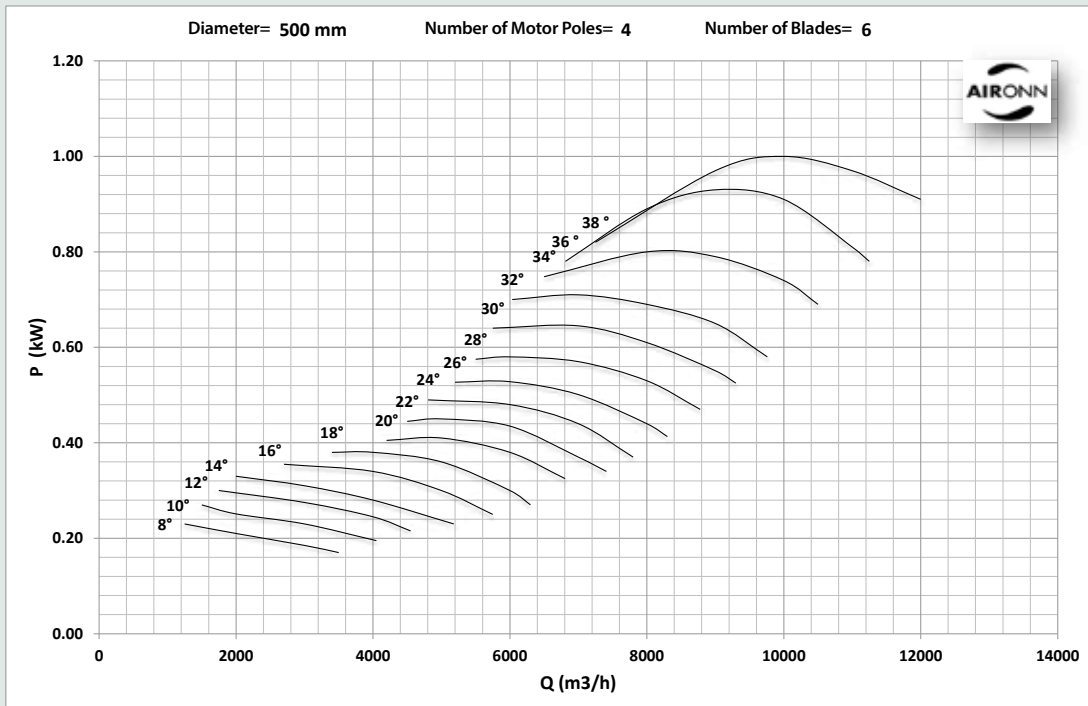
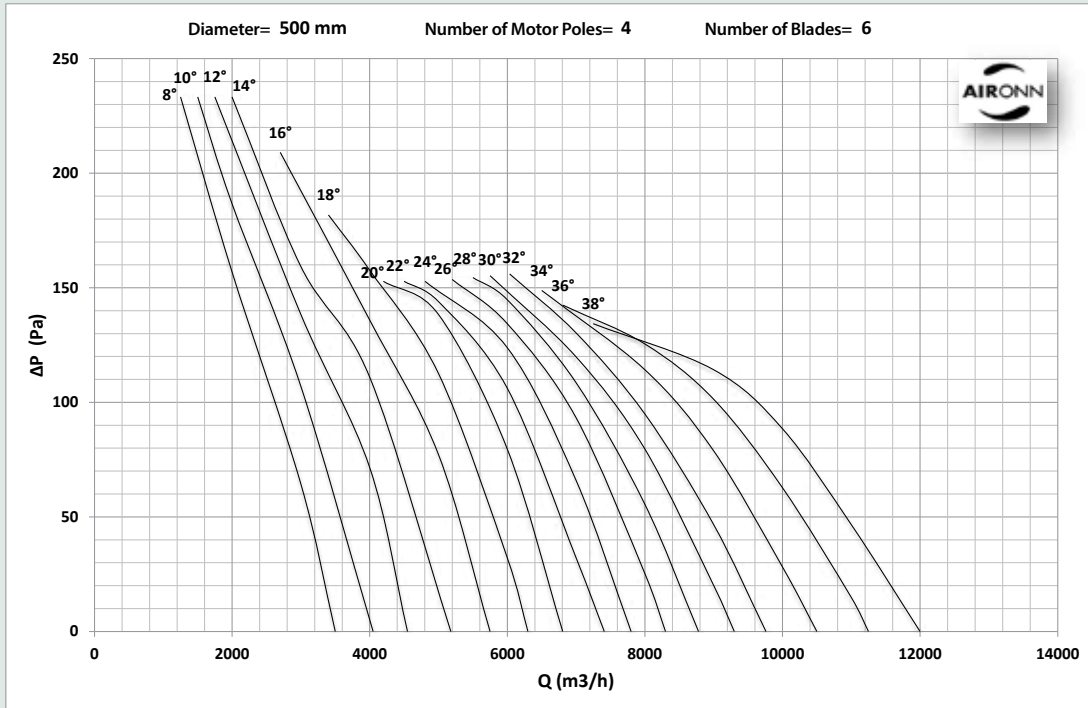

# Roof Type Axial (Vertical) Smoke Exhaust Fan Series

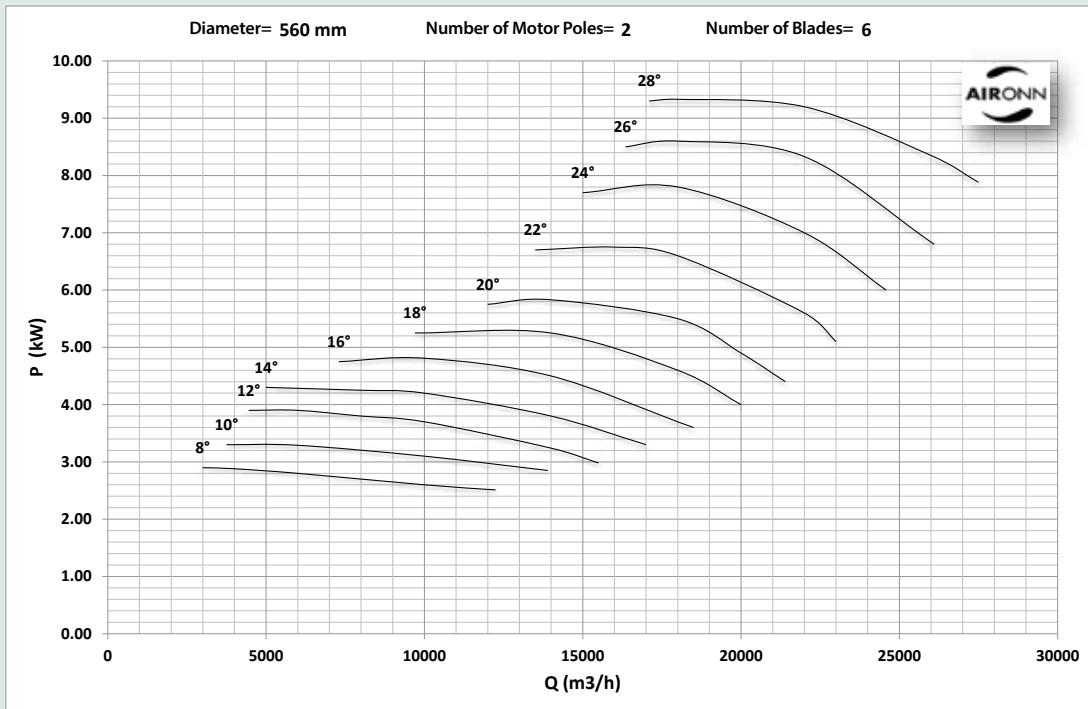
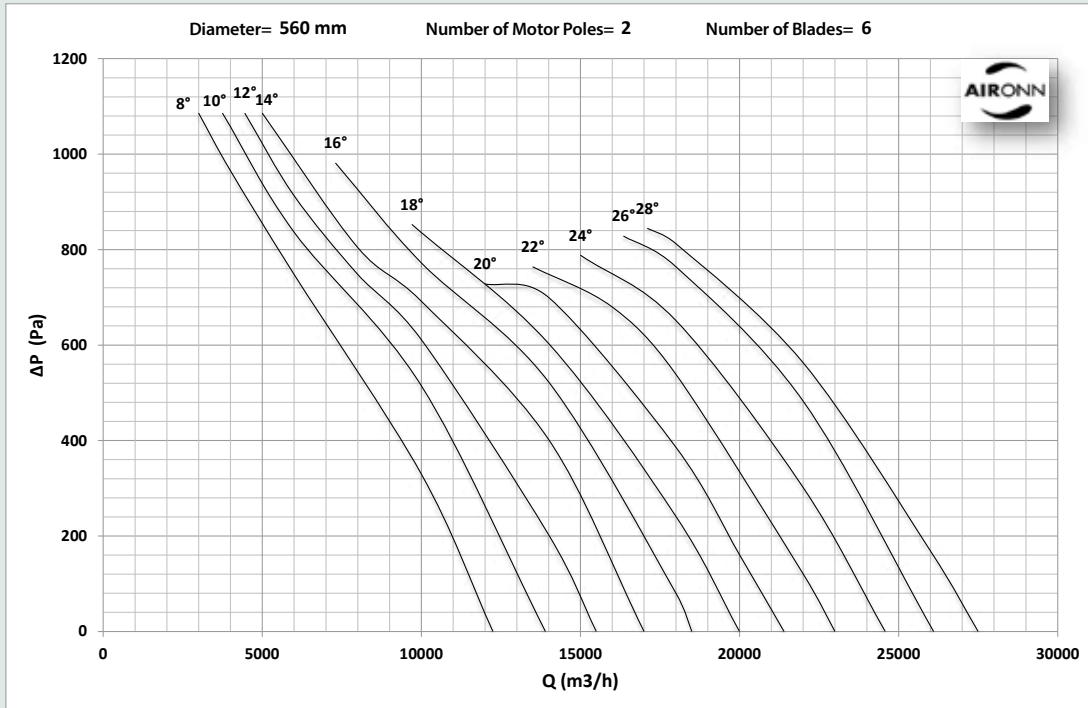

# Roof Type Axial (Vertical) Smoke Exhaust Fan Series

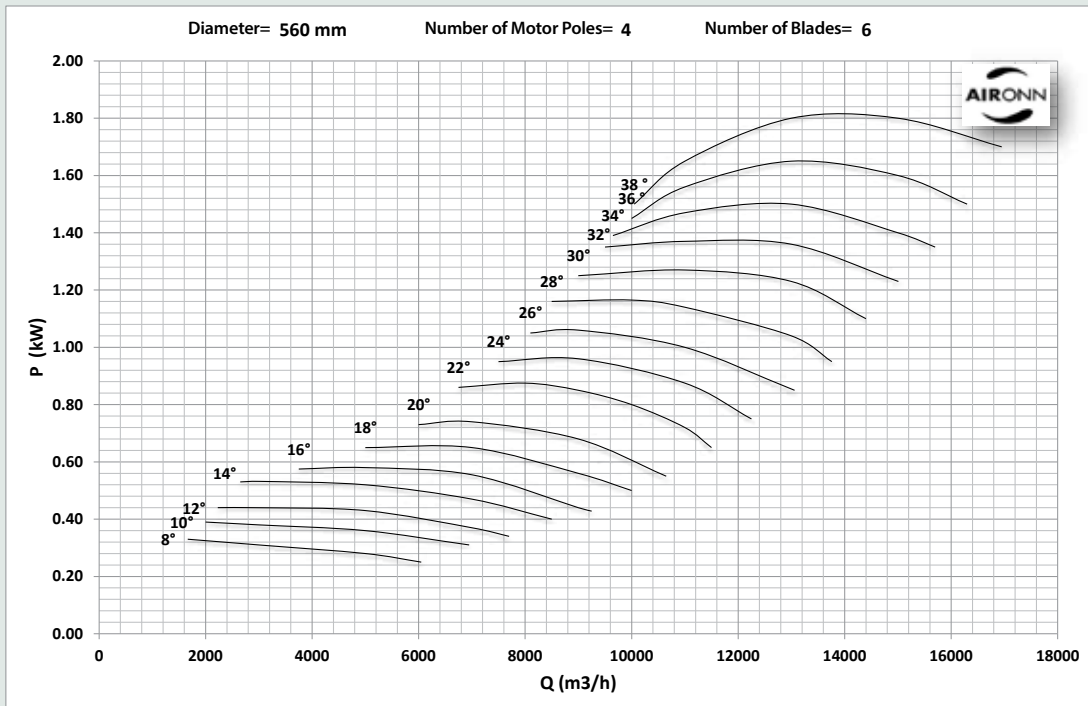
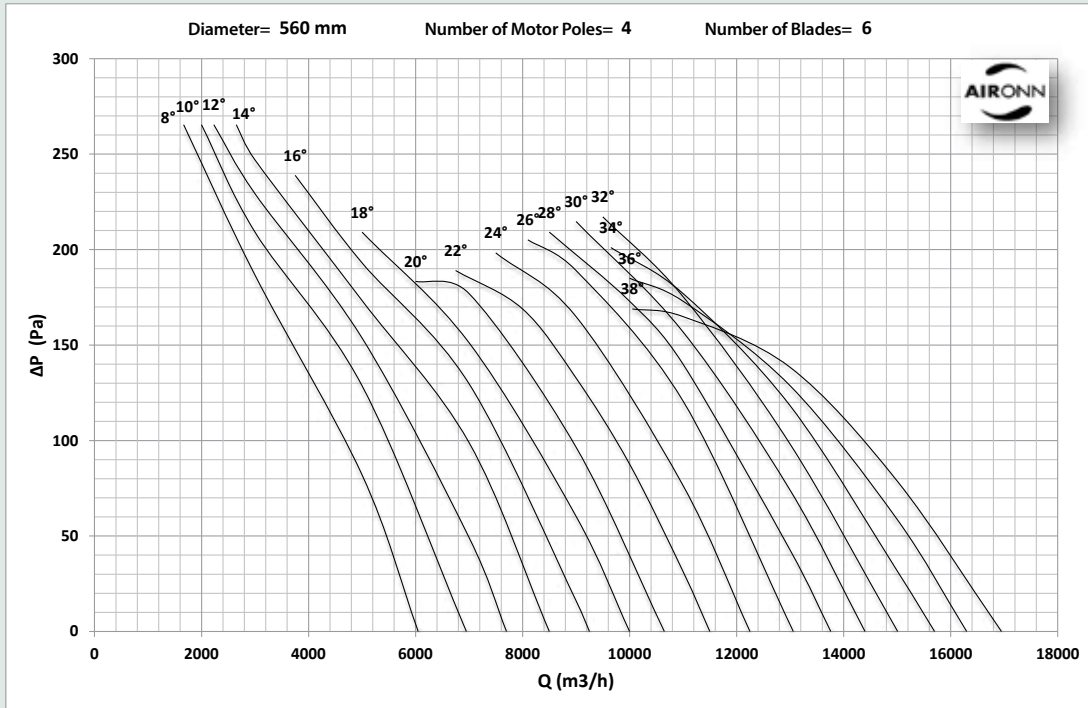



# Roof Type Axial (Vertical) Smoke Exhaust Fan Series

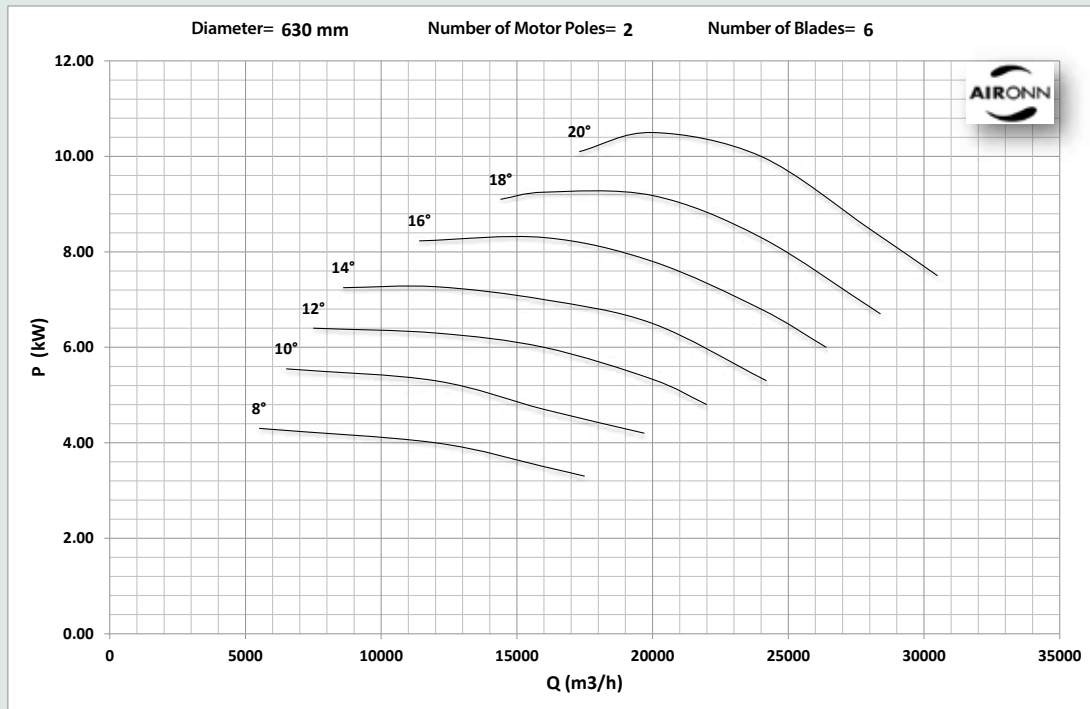
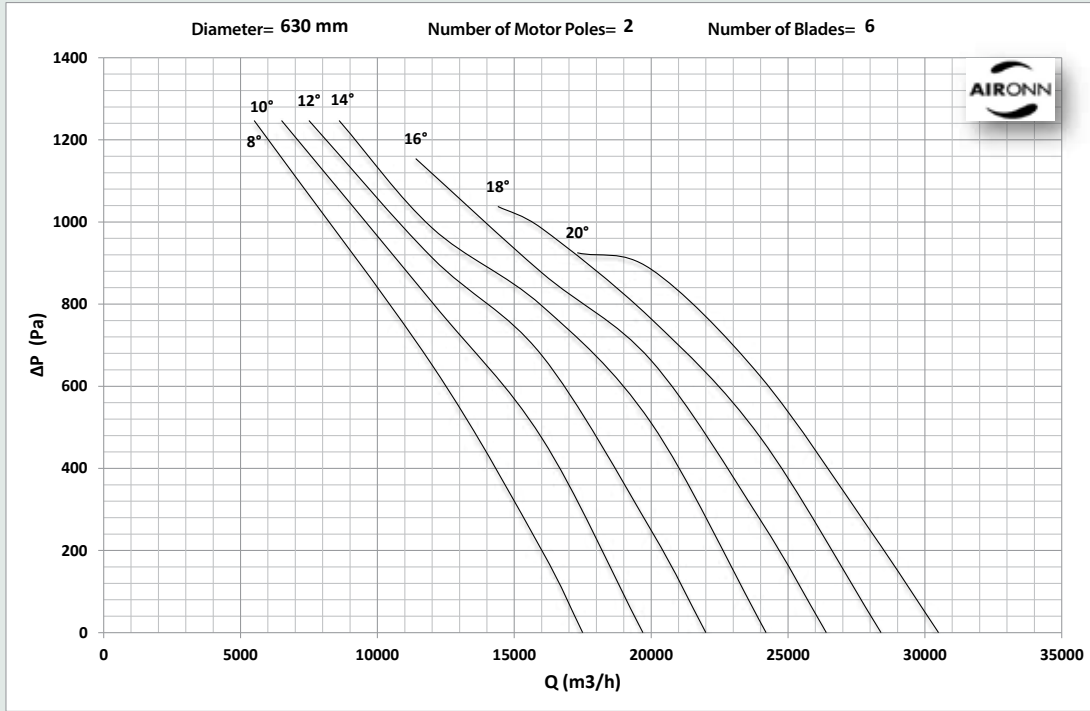

# Roof Type Axial (Vertical) Smoke Exhaust Fan Series

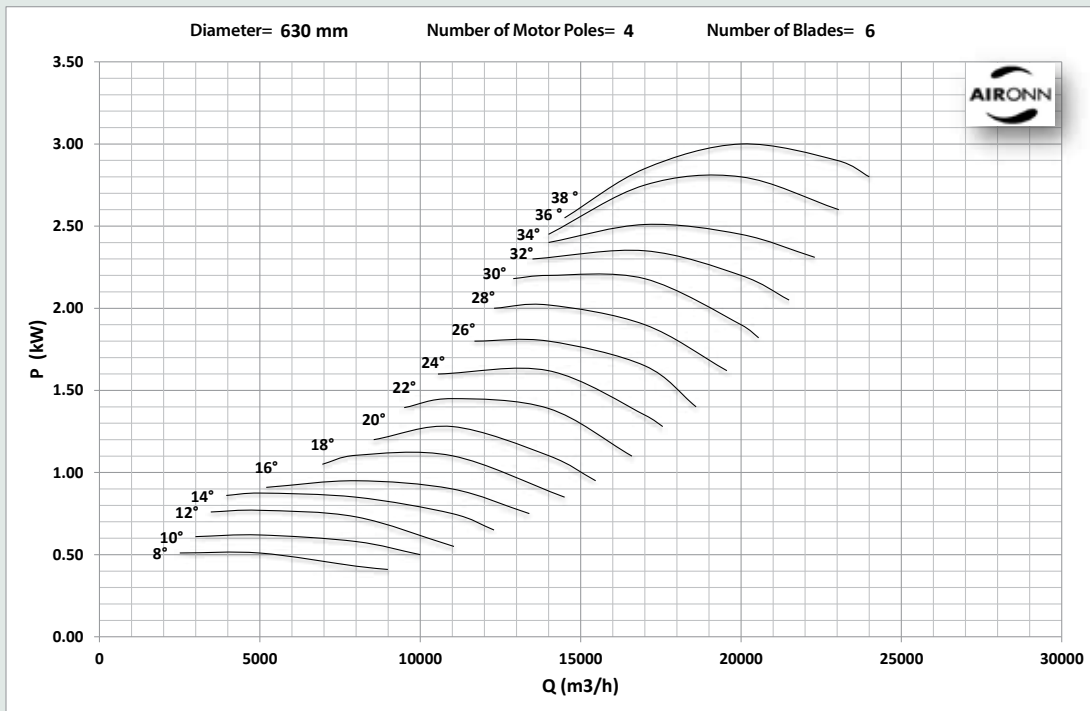
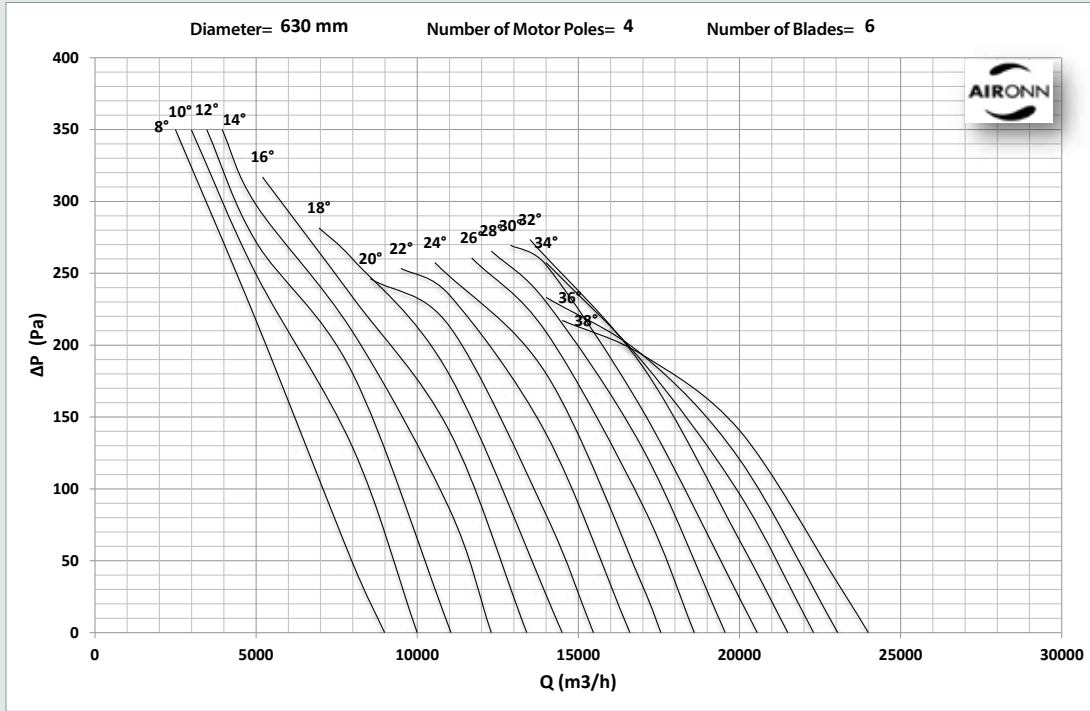

# Roof Type Axial (Vertical) Smoke Exhaust Fan Series

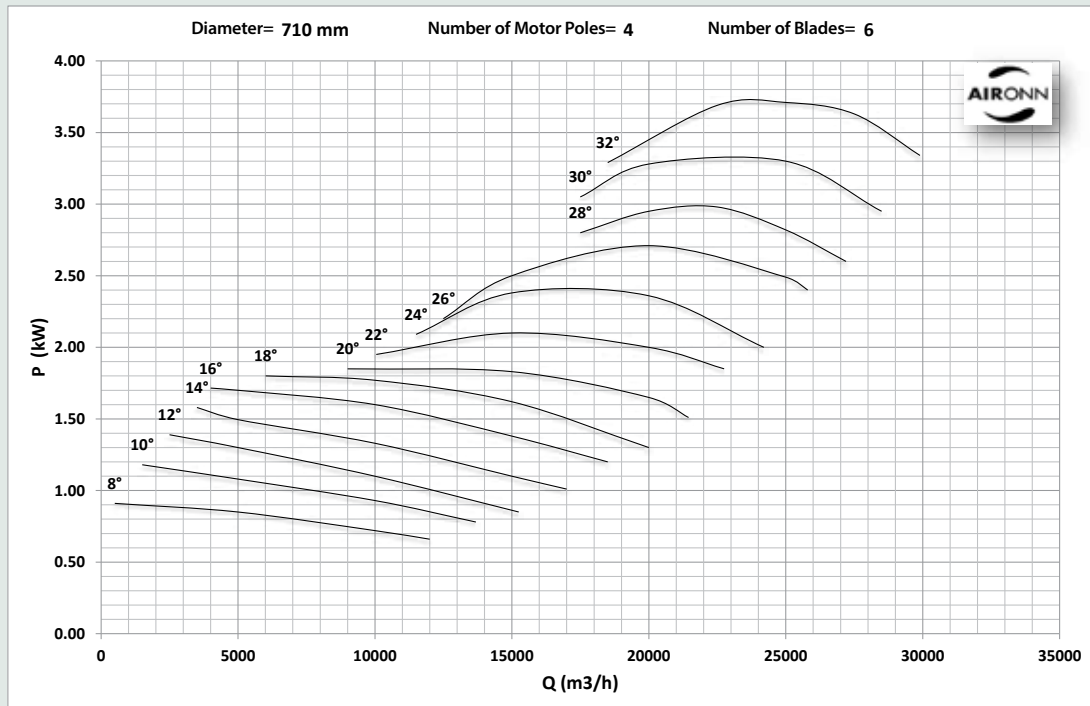
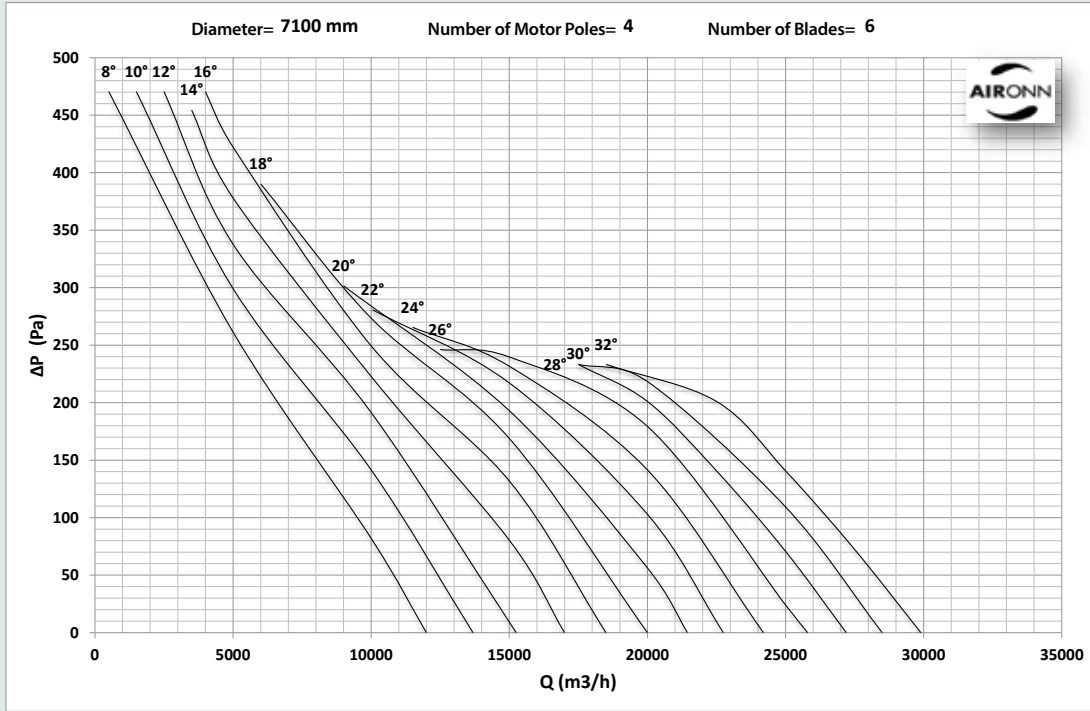

# Roof Type Axial (Vertical) Smoke Exhaust Fan Series

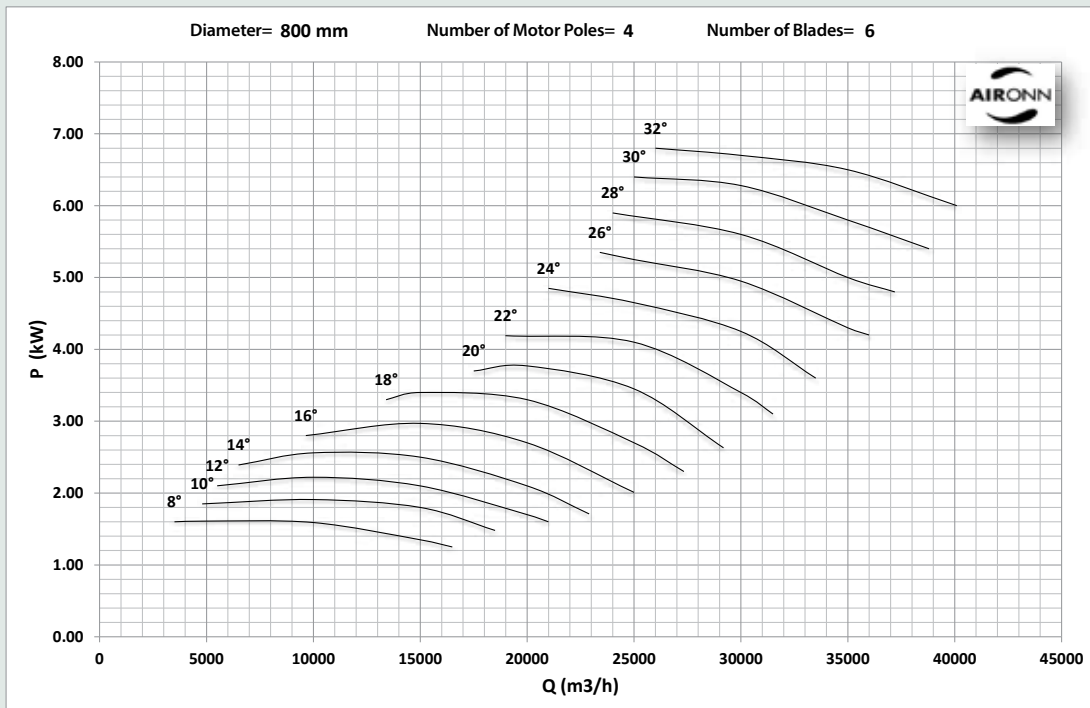
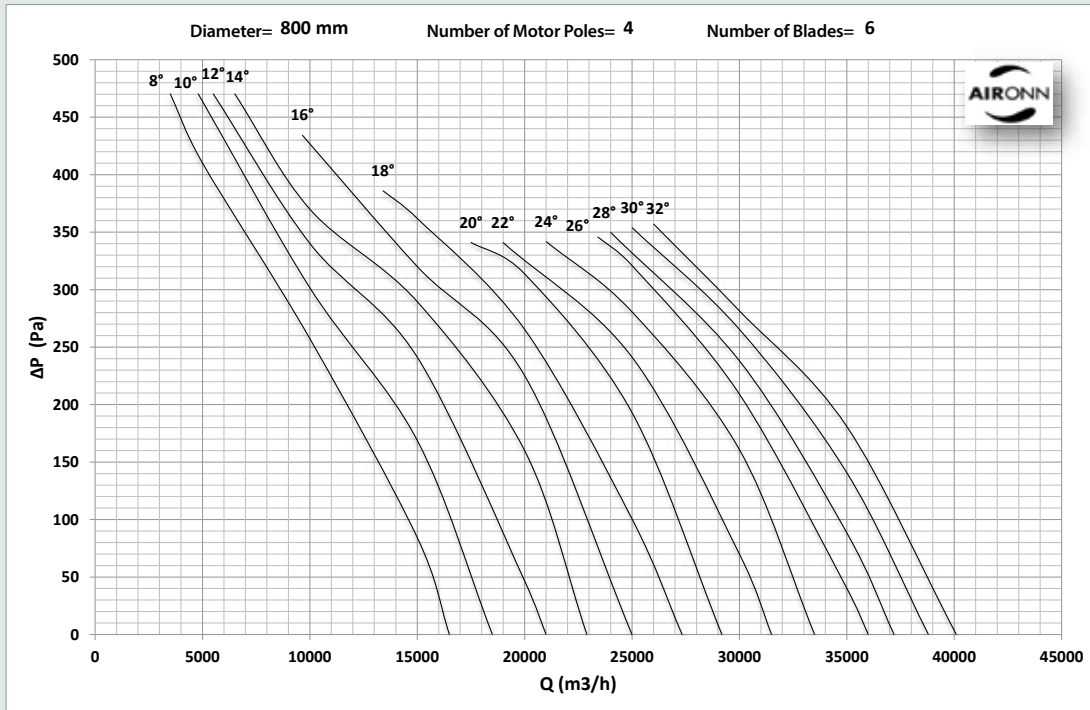

# Roof Type Axial (Vertical) Smoke Exhaust Fan Series

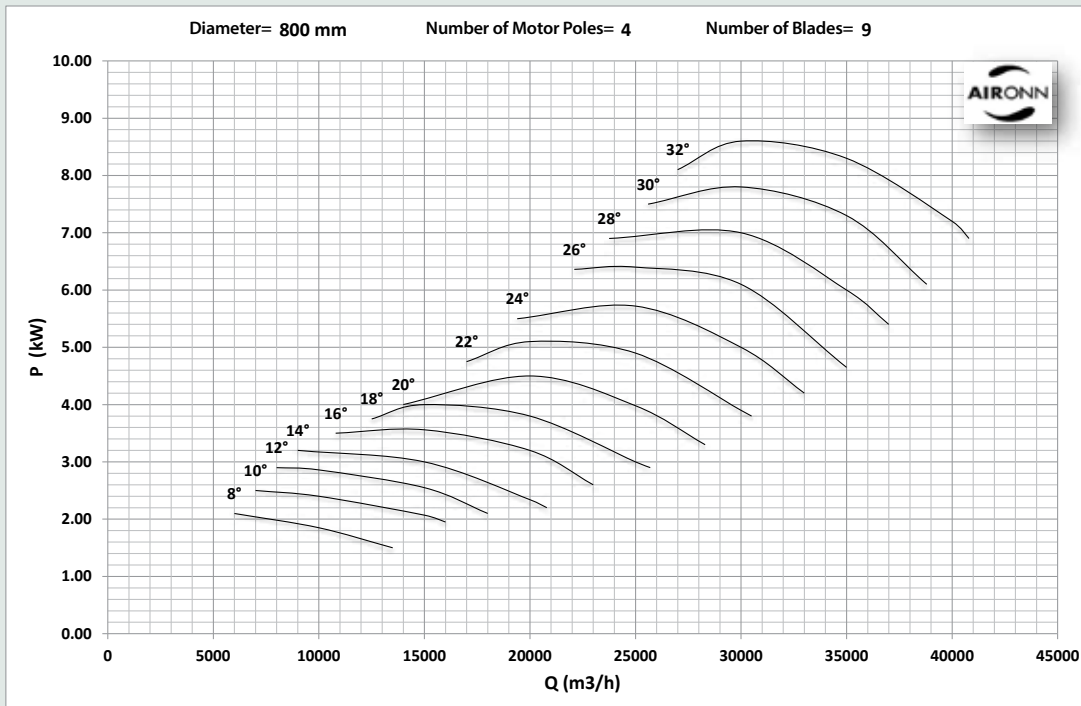
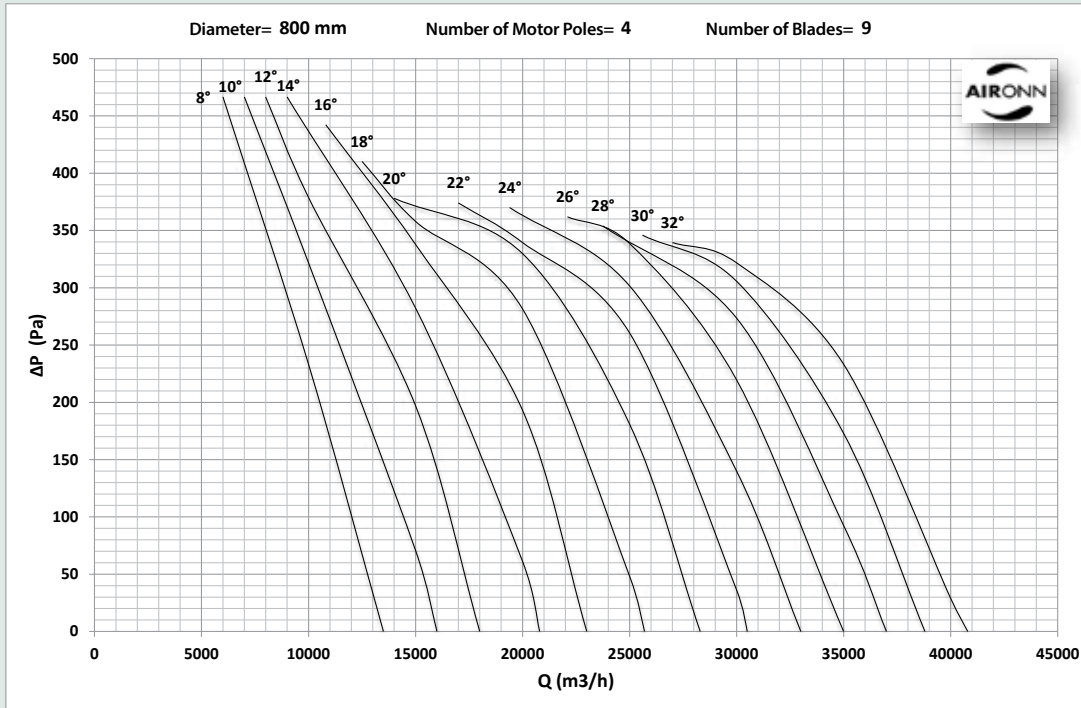

# Roof Type Axial (Vertical) Smoke Exhaust Fan Series

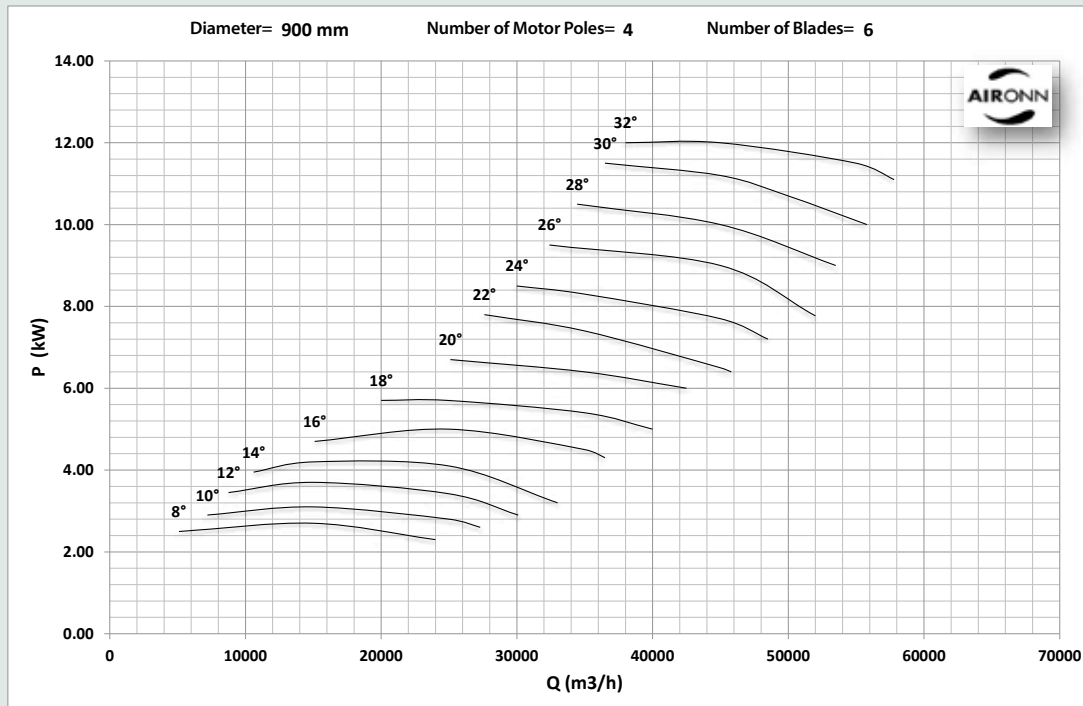
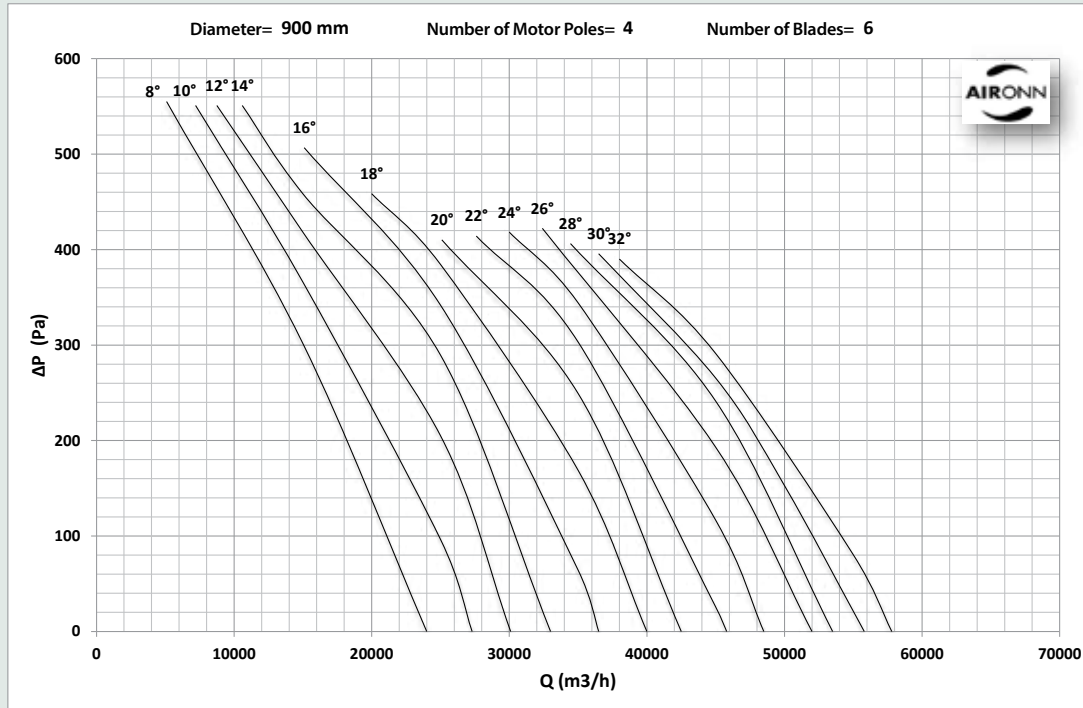

# Roof Type Axial (Vertical) Smoke Exhaust Fan Series

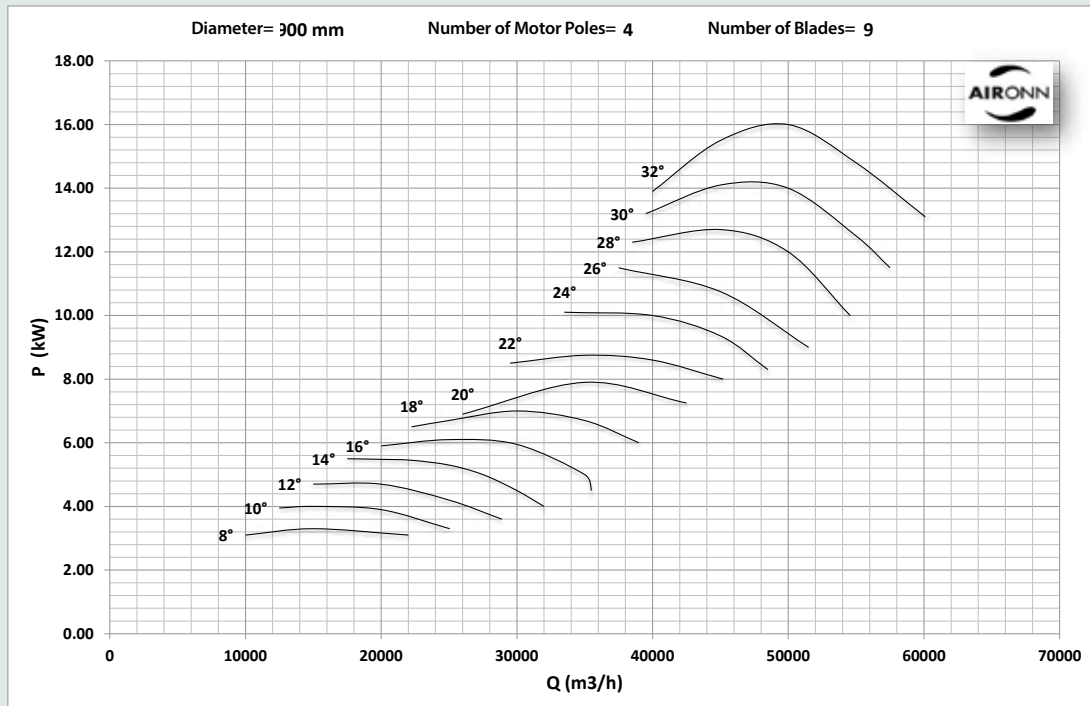
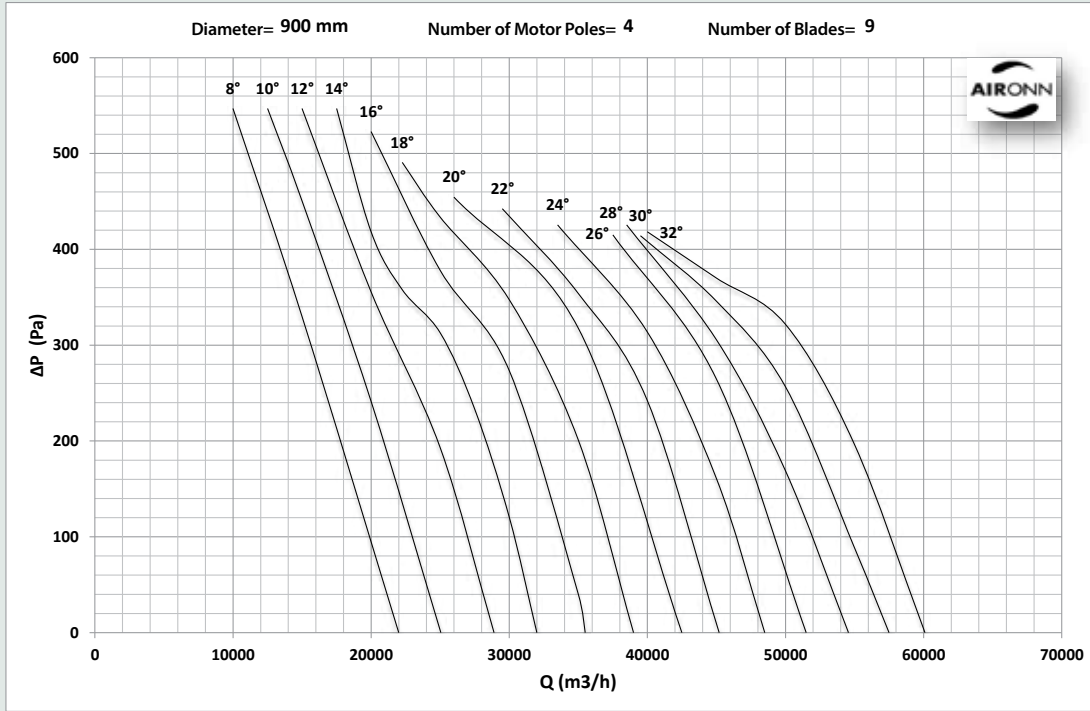

# Roof Type Axial (Vertical) Smoke Exhaust Fan Series

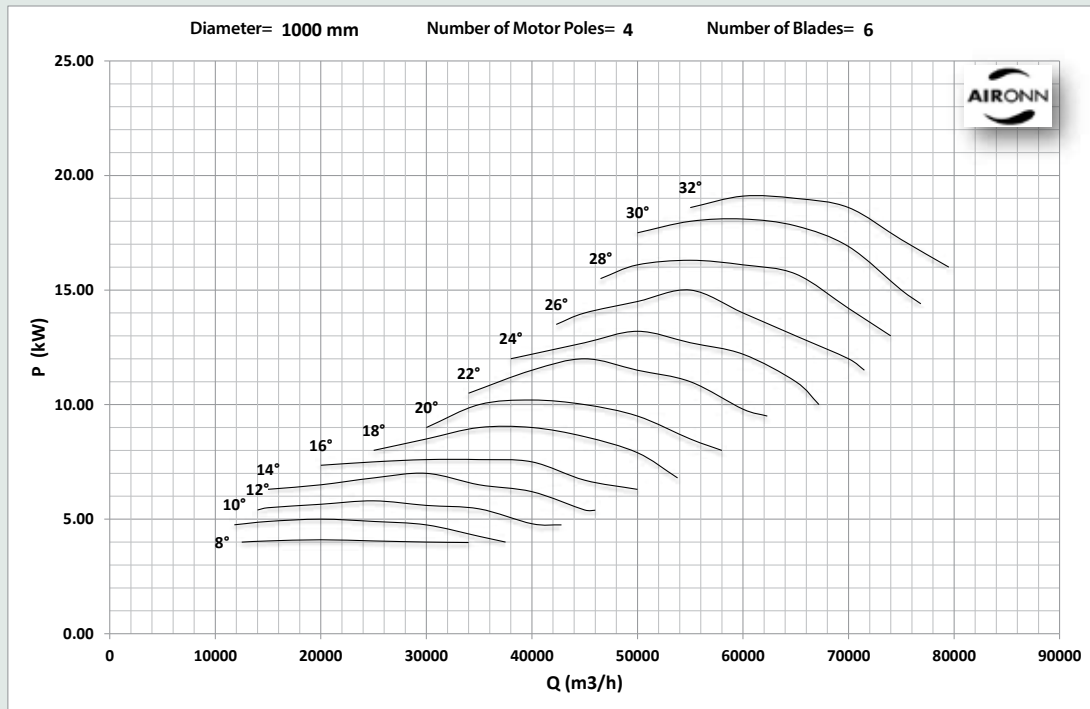
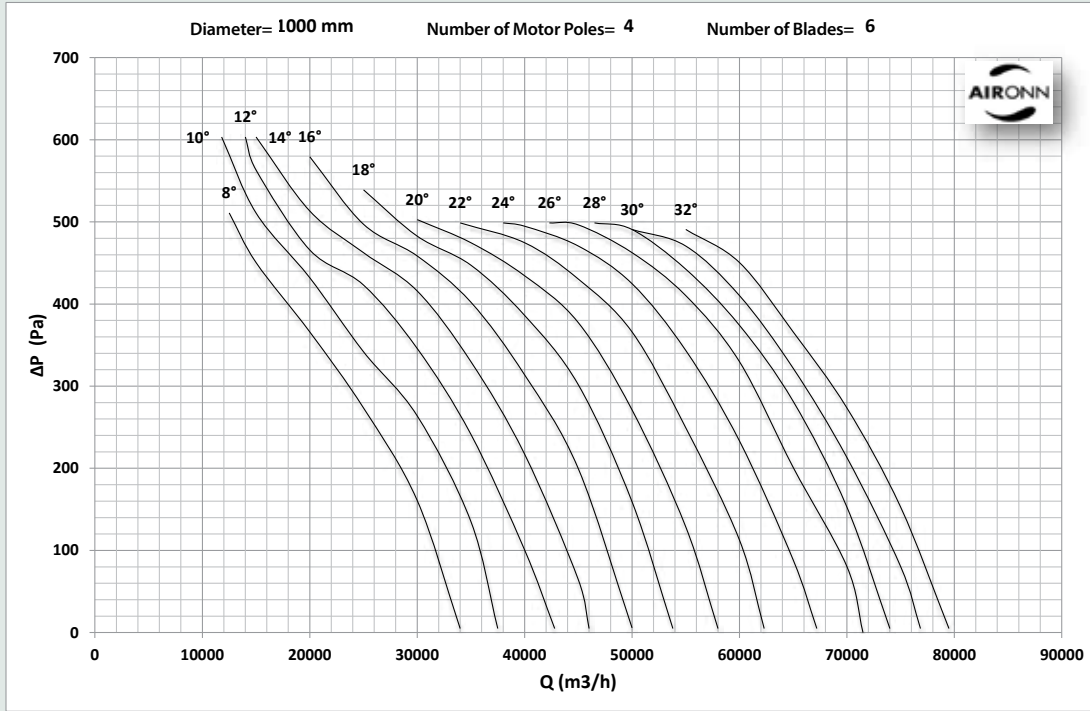



# Roof Type Axial (Vertical) Smoke Exhaust Fan Series

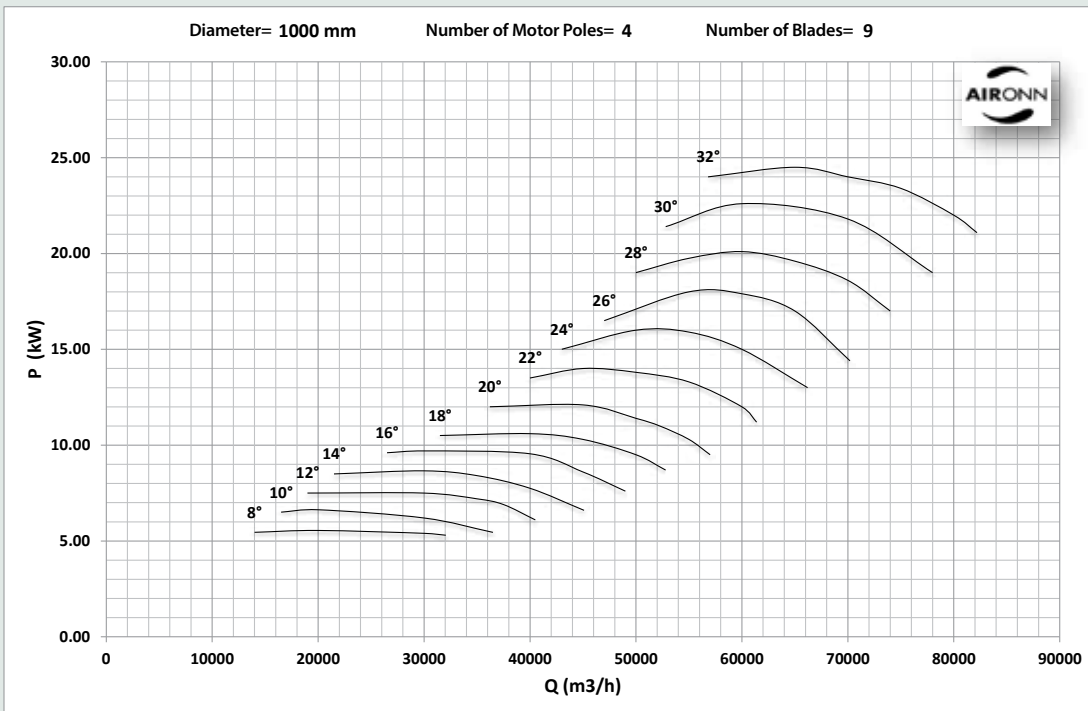
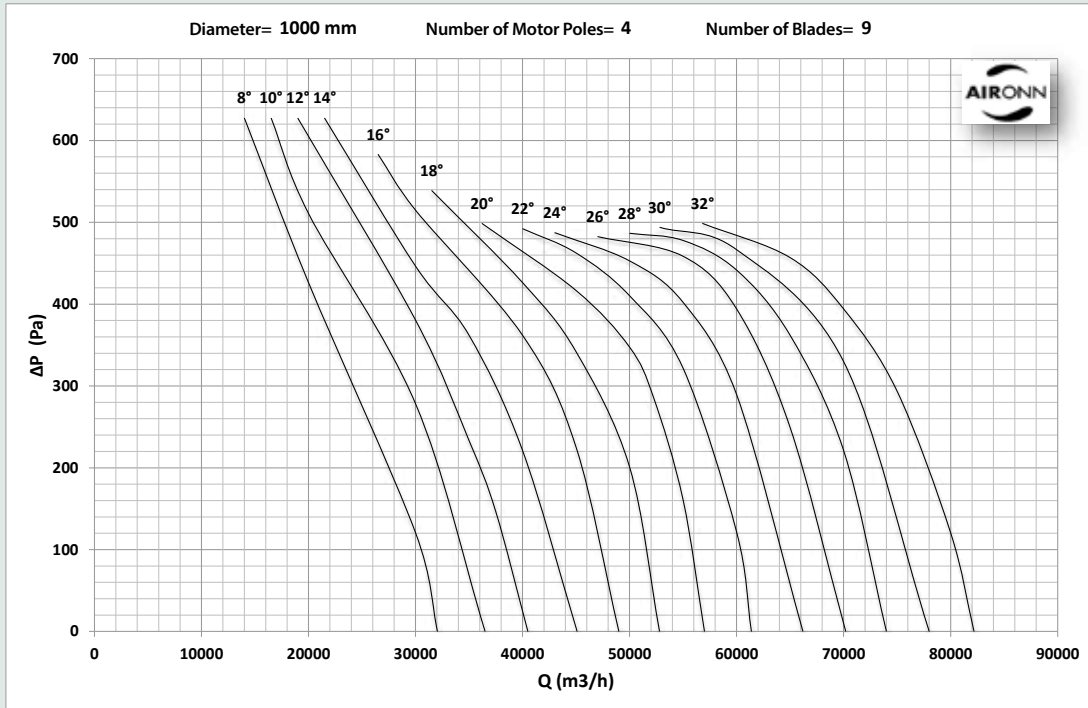

# Roof Type Axial (Vertical) Smoke Exhaust Fan Series

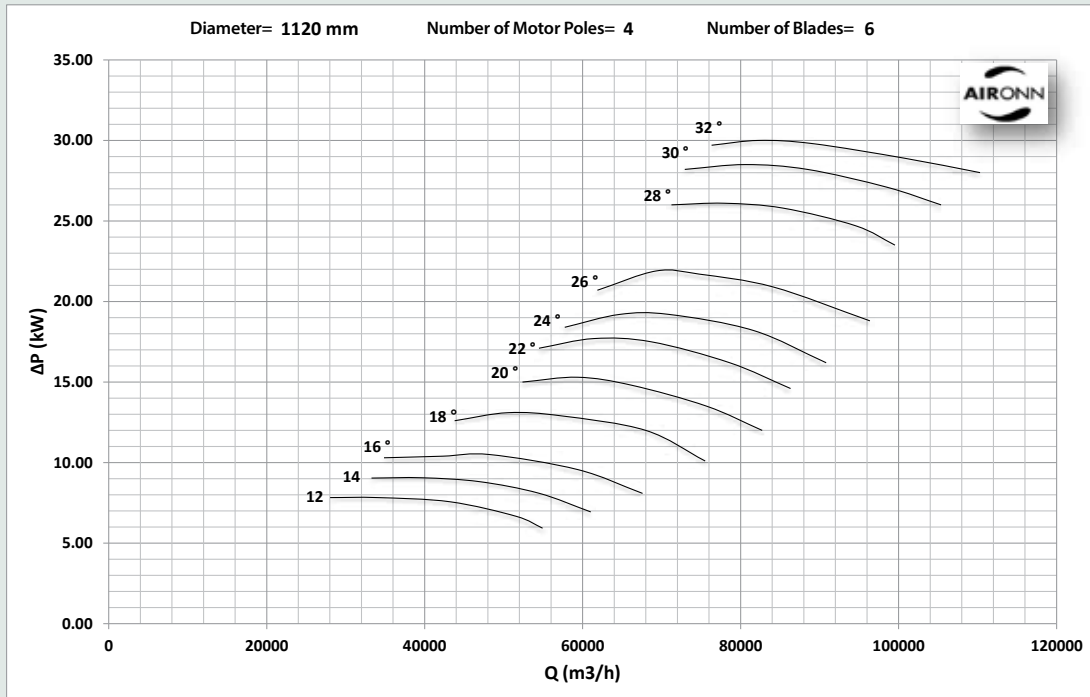
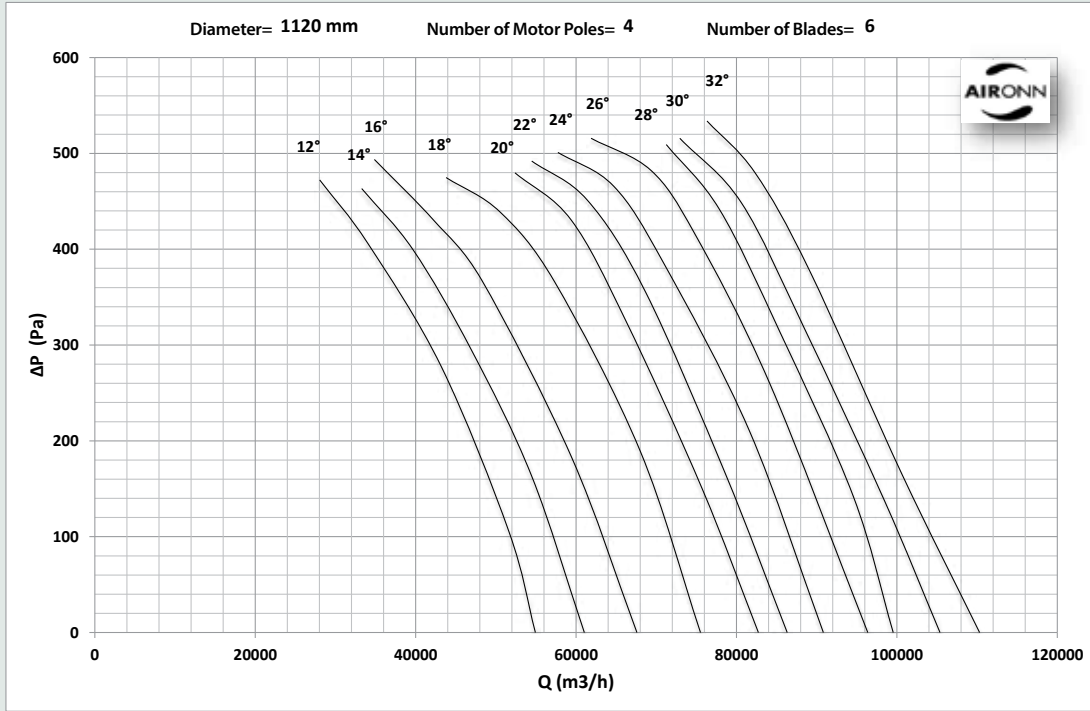

# Roof Type Axial (Vertical) Smoke Exhaust Fan Series

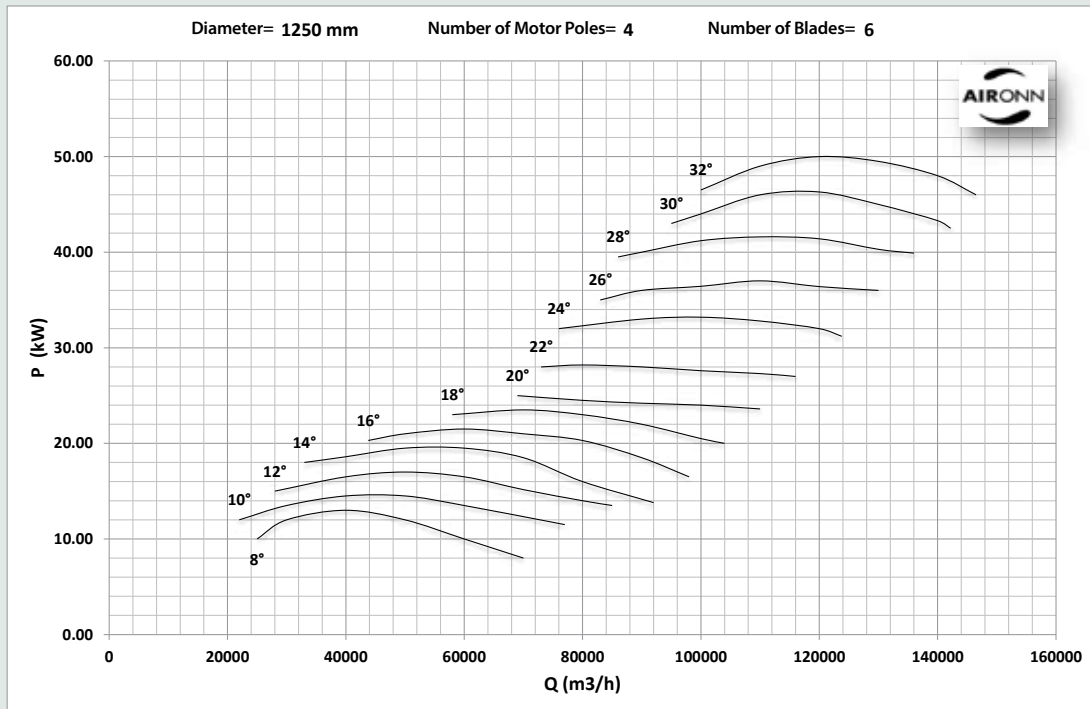
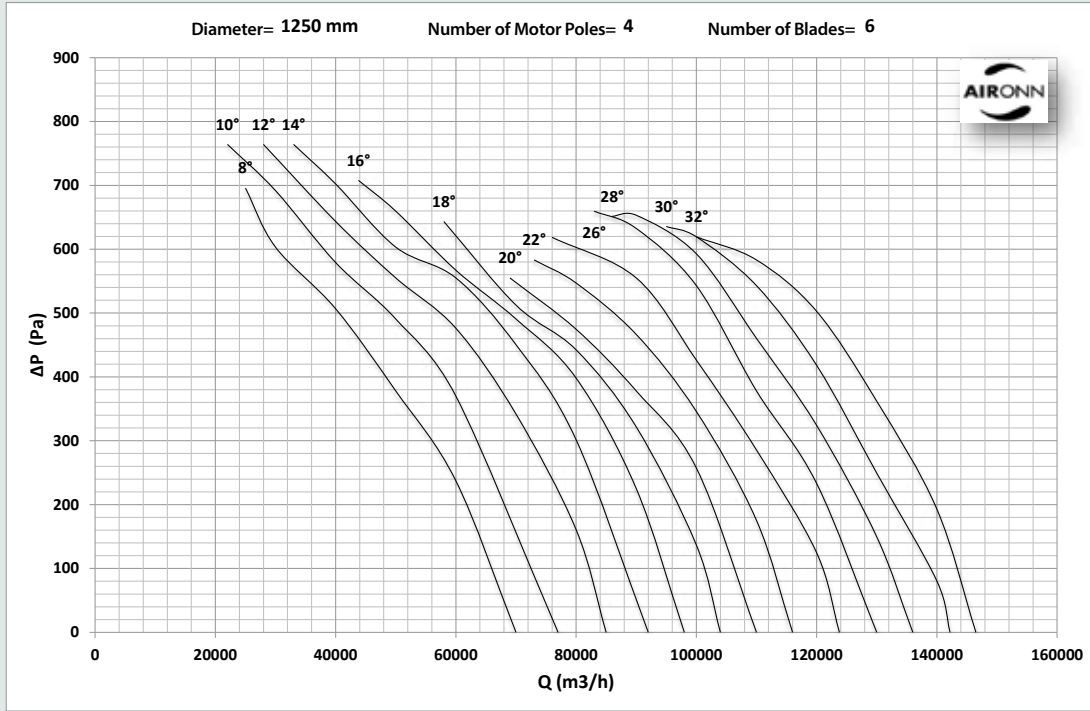

# Roof Type Axial (Vertical) Smoke Exhaust Fan Series

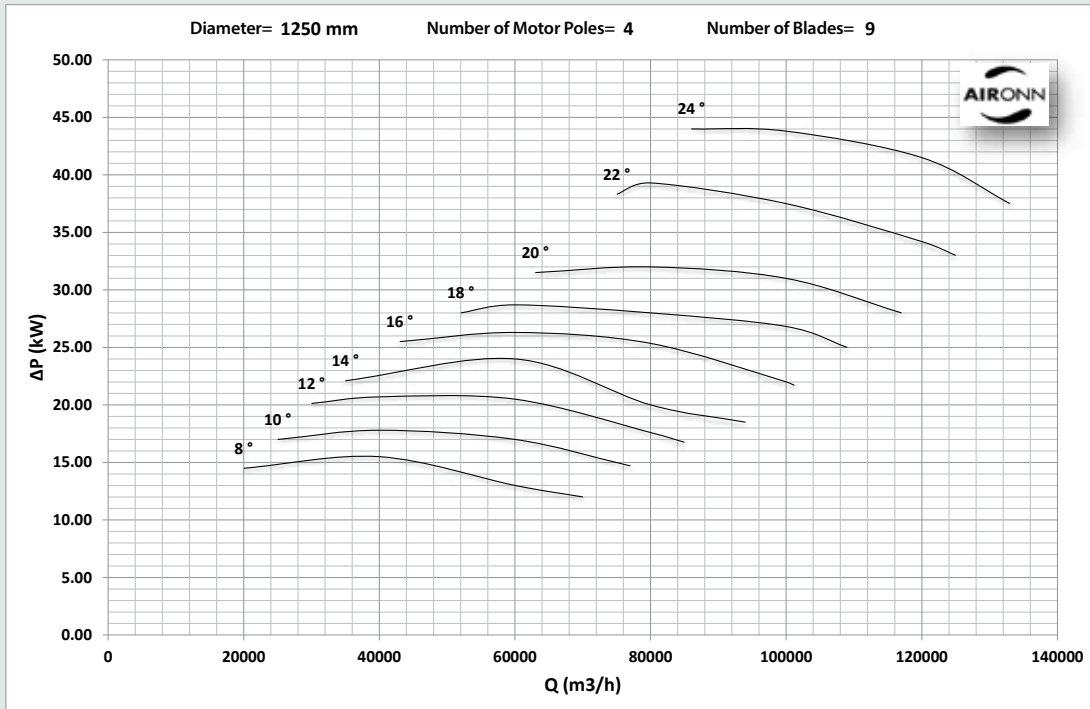
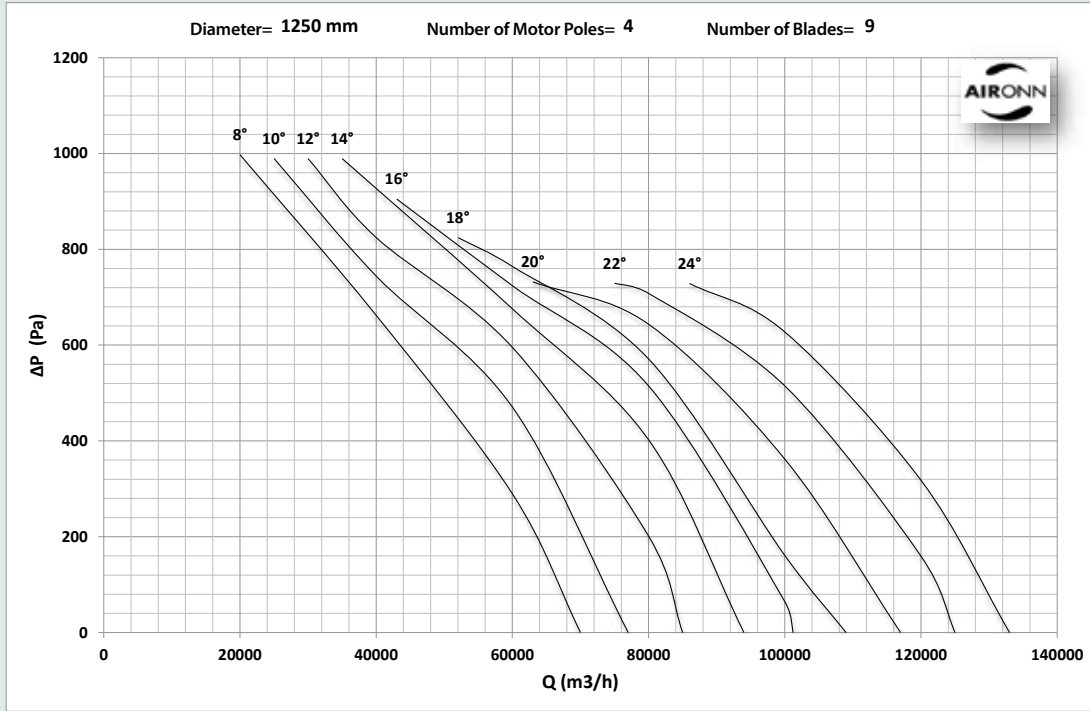



# Cell Type Axial Smoke Exhaust Fan Series

Fans in the Aironn Cell Type Axial Smoke Exhaust Fan series have 300 ° C-2 hours and 400 ° C-2 hours certificates in compliance with EN 12101-3. Adjustable edge angle of the series in the range of diameters between 400 mm and 1250 mm presents a broad performance range. It also provides an advantage by precisely ensuring the required flow. Performance of the fans in Cell Type Axial Smoke Exhaust Fan Series have been tested in accordance with AMCA 210-07 standard.

## Fan Body

Frame of the fan cell is made of rolled-aluminium shape and cast aluminium corners. Cabin body is made of high quality galvanized steel. Cabin bodies are insulated with 50 mm-thick non-flame-propagating rock wool layer. Thus it has advanced acoustical performance. Inspection hatch is standard in the series.

## Fan Blades

Aerodynamic fan blades are made of ETIAL 171 with injection moulding method. They are statically and dynamically balanced in compliance with ISO 1940/1-2003.

## Motor

IP 55 motors with class H insulation are available in single cycle or double cycle options. If requested, single cycle motors can be used with inverters.

## Electricity

Electricity terminal box coupled with the body has IP 55 protection rating and standard.

## Accessories

Back Draft Damper Spring Insulator, Flexible Coupling, Pacco (Package) Switch, Vibration Sensor, Inverter



# Cell Type Axial Fresh Air Fan Series

Fans in Aironn Cell Type Smoke Exhaust Fan Series are suitable to operate at maximum 55 °C. Adjustable edge angle of the series in the range of diameters between 400 mm and 1250 mm presents a broad performance range. It also provides an advantage by precisely ensuring the required flow. Performance of the fans in Cell Type Axial Smoke Exhaust Fan Series have been tested in accordance with AMCA 210-07 standard.

## Fan Body

Frame of the fan cell is made of rolled-aluminium shape and cast aluminium corners. Cabin body is made of high quality galvanized steel. Cabin bodies are insulated with 50 mm-thick non-flame-propagating rock wool layer. Thus it has advanced acoustical performance. Inspection hatch is standard in the series.

## Fan Blades

Aerodynamic fan blades are made of ETIAL 171 with injection moulding method. They are statically and dynamically balanced in compliance with ISO 1940/1-2003.

## Motor

IP 55 motors with class F insulation are available in single cycle or double cycle options. If requested, single cycle motors can be used with inverters.

## Electricity

Electricity terminal box coupled with the body has IP 55 protection rating and standard.

## Accessories

Back Draft Damper, Spring Insulator, Flexible Coupling, Pacco (Package) Switch, Vibration Sensor, Inverter



## Cell Type Axial Smoke exhaust & Fresh Air Fan Series

### Dimensions

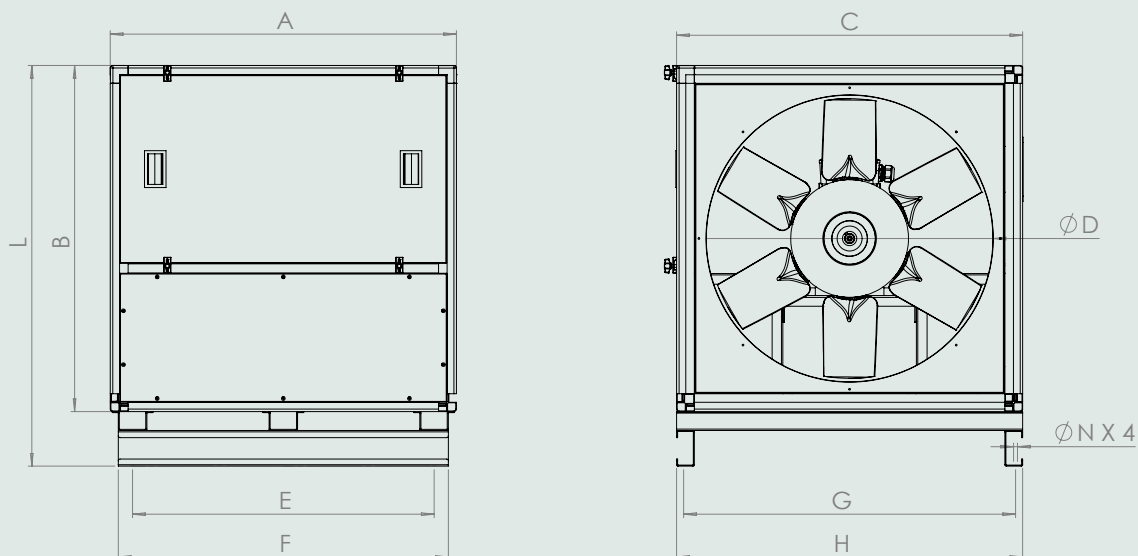

	A	B	C	D	E	F	G	H	L	Ø N
400	570	570	570	400	445	525	530	570	723	9
450	620	620	620	450	495	575	580	620	773	9
500	670	670	670	500	545	625	630	670	823	9
560	730	730	730	560	605	685	690	730	883	9
630	800	800	800	630	675	755	760	800	953	9
710	880	880	880	710	755	835	840	880	1033	9
800	970	970	970	800	845	925	930	970	1123	11
900	1070	1070	1070	900	945	1025	1030	1070	1223	11
1000	1170	1170	1170	1000	1045	1125	1130	1170	1323	11
1250	1420	1420	1420	1250	1295	1375	1380	1420	1573	11



# Cell Type Axial Fresh Air Fan Series

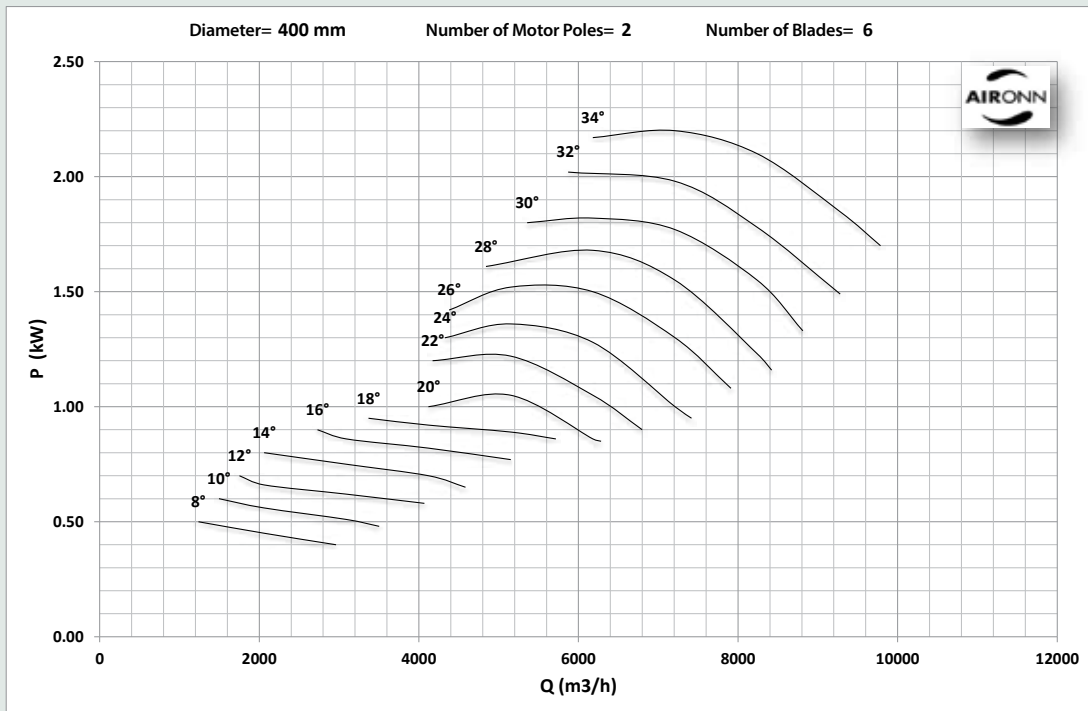
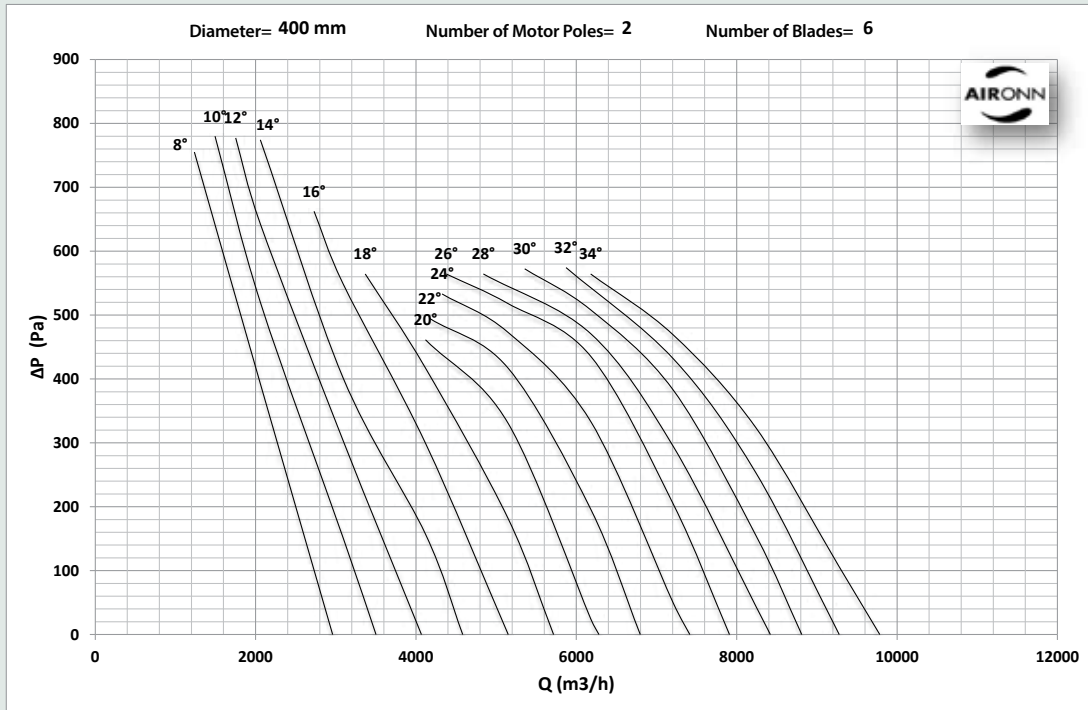

# Cell Type Axial Fresh Air Fan Series

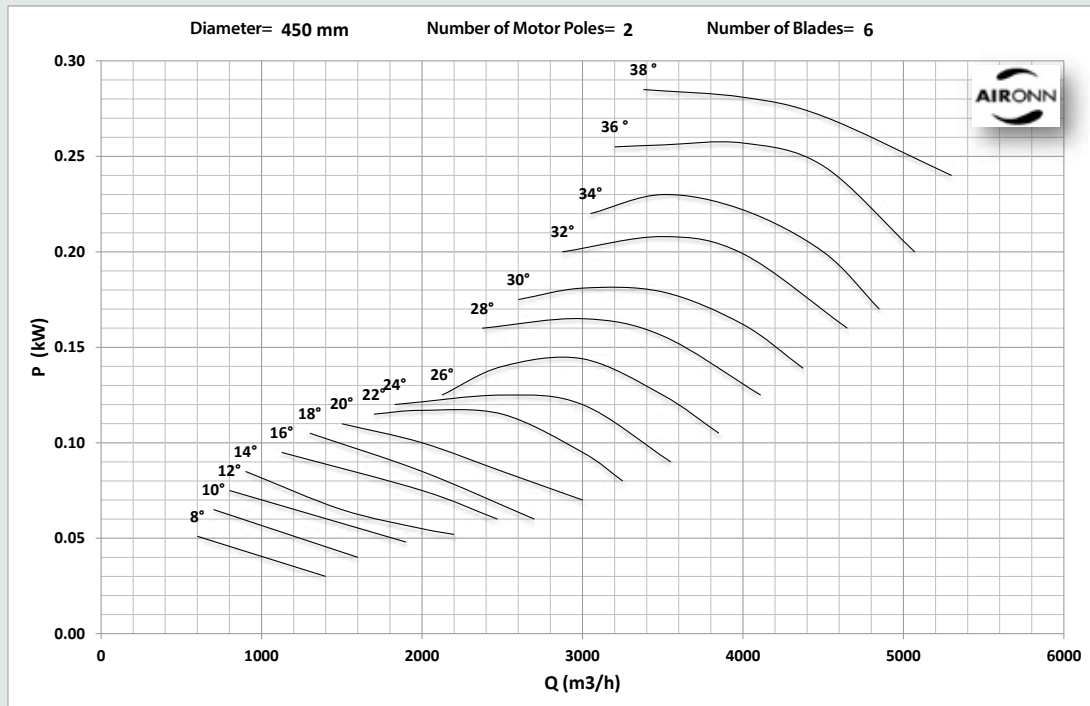
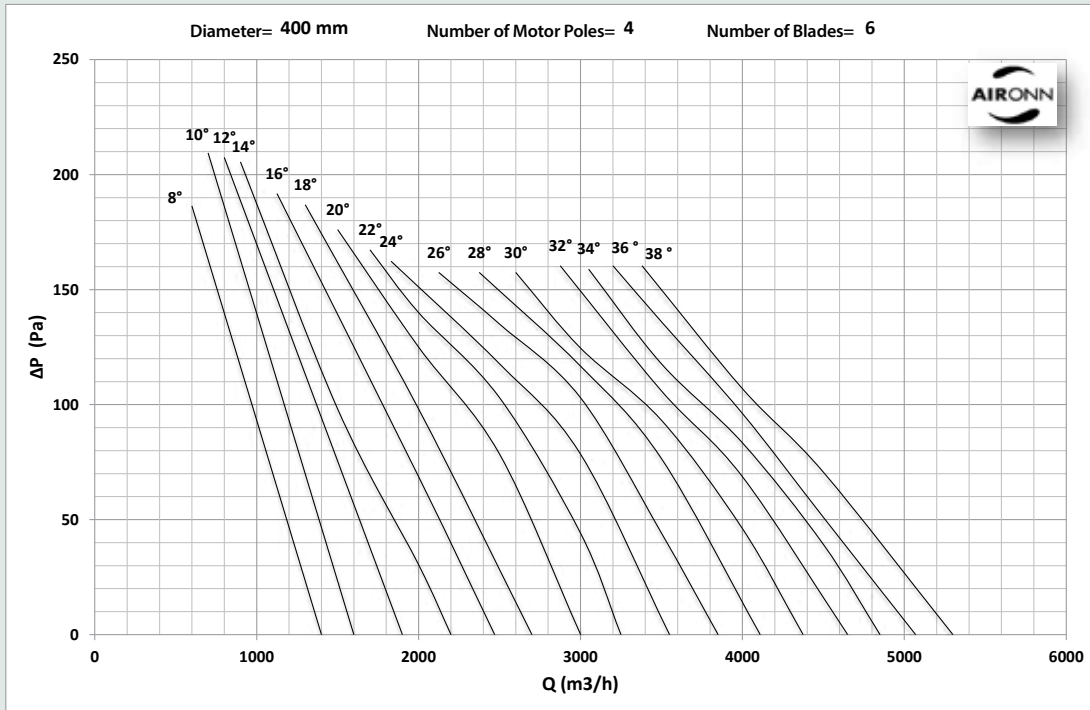

# Cell Type Axial Fresh Air Fan Series

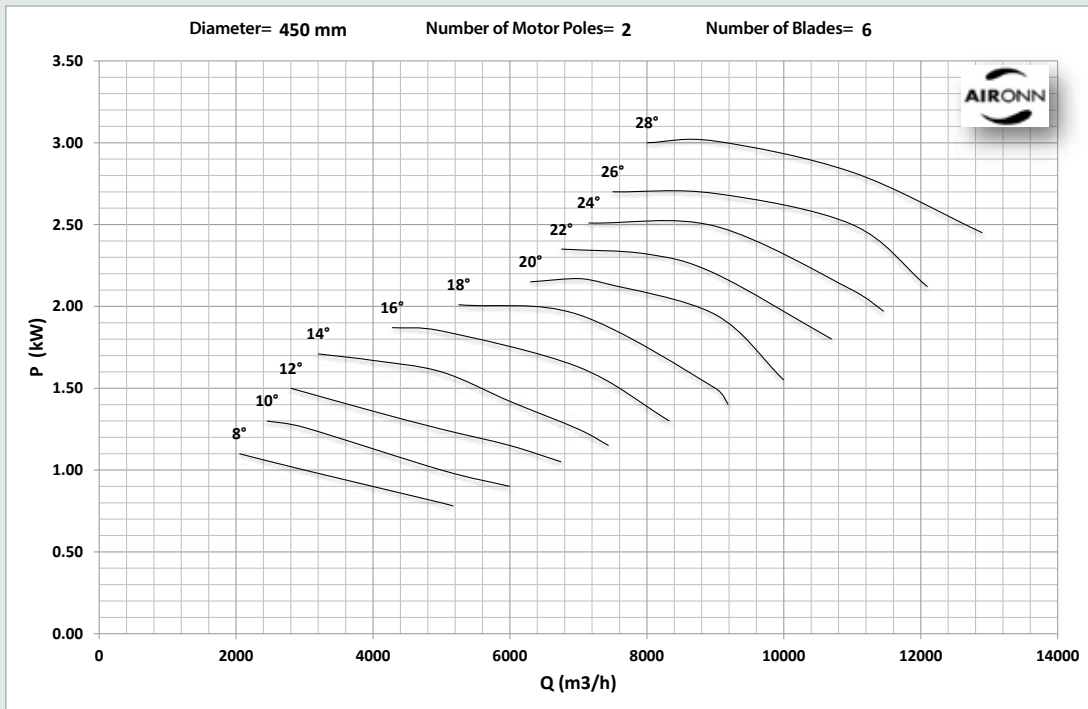
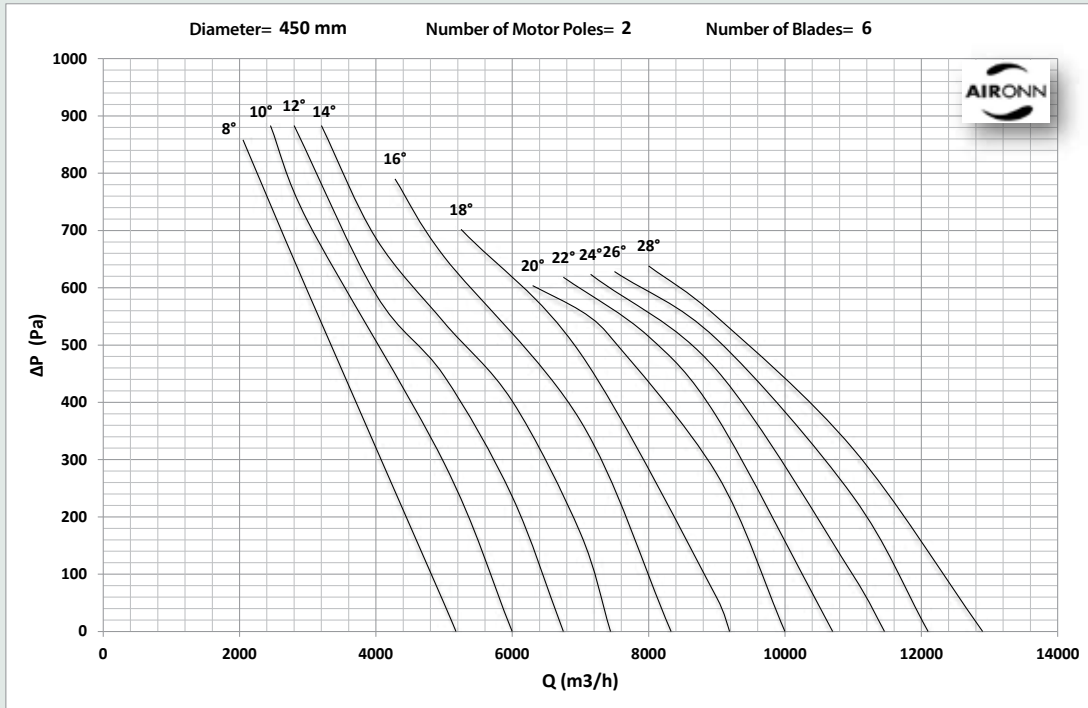

# Cell Type Axial Fresh Air Fan Series

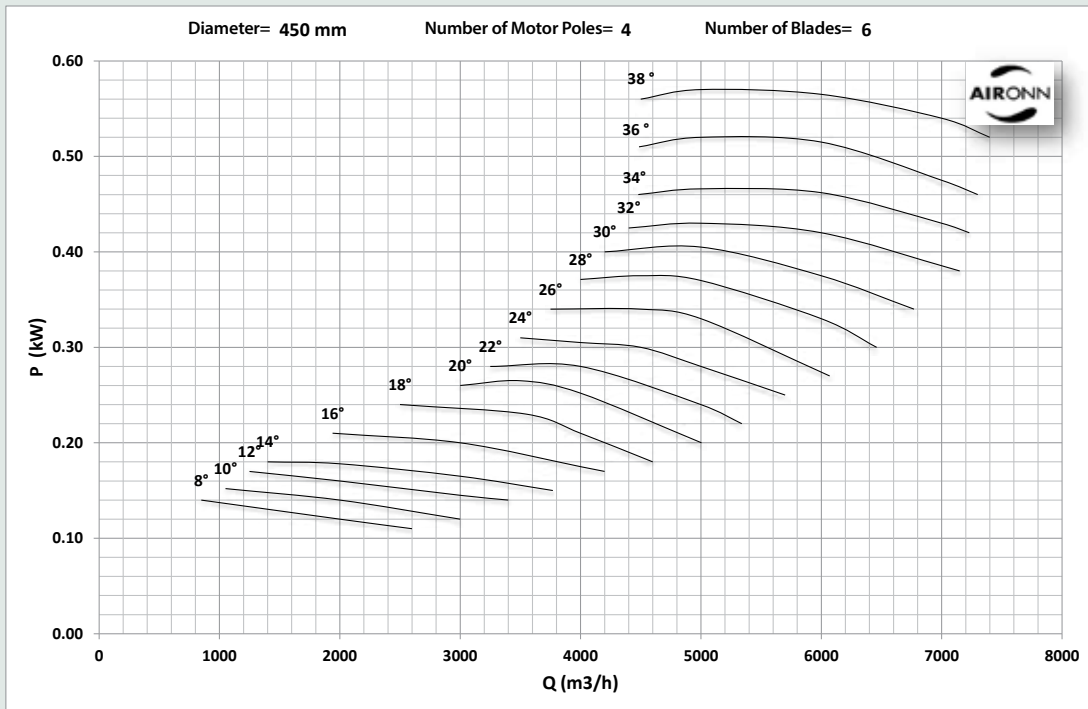
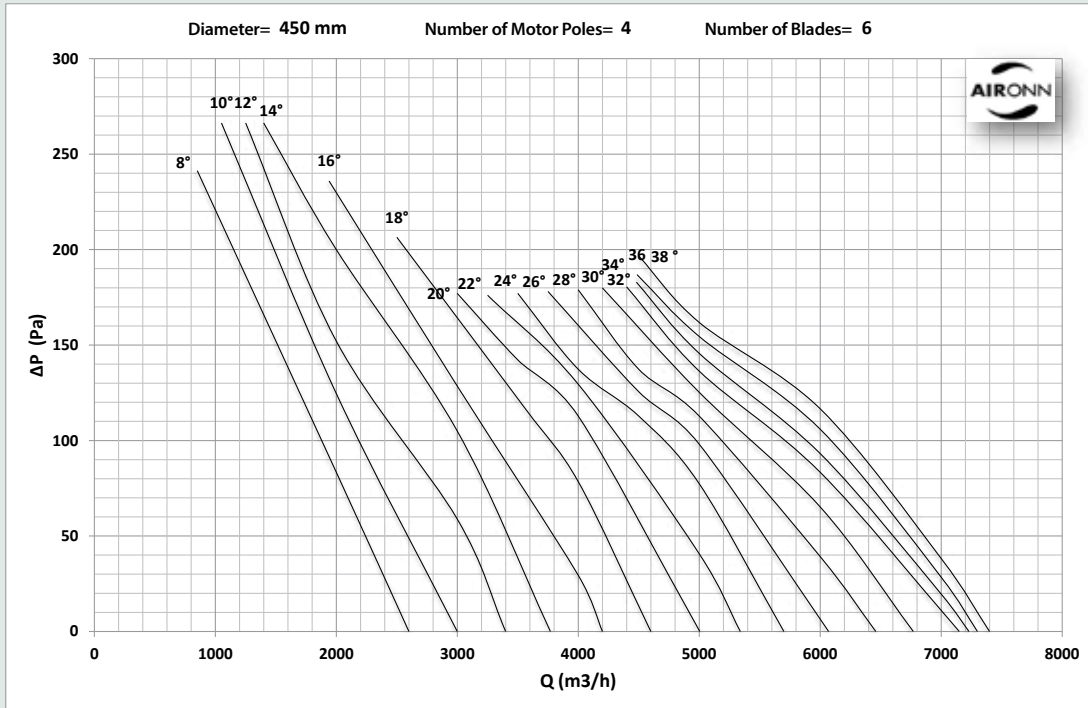

# Cell Type Axial Fresh Air Fan Series

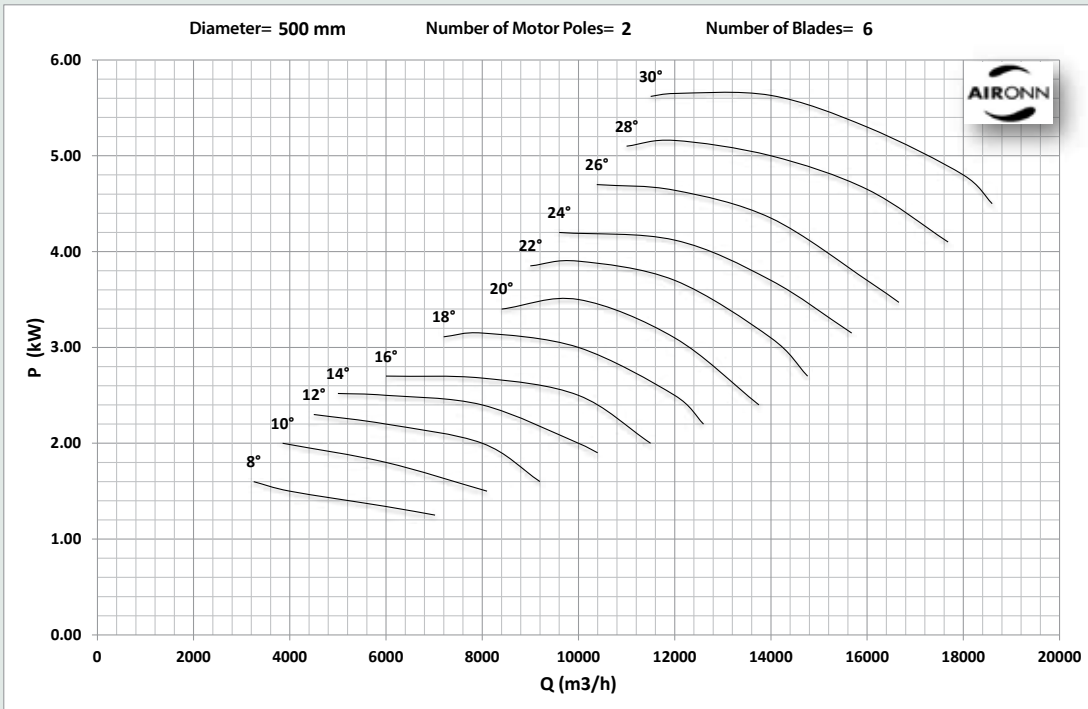
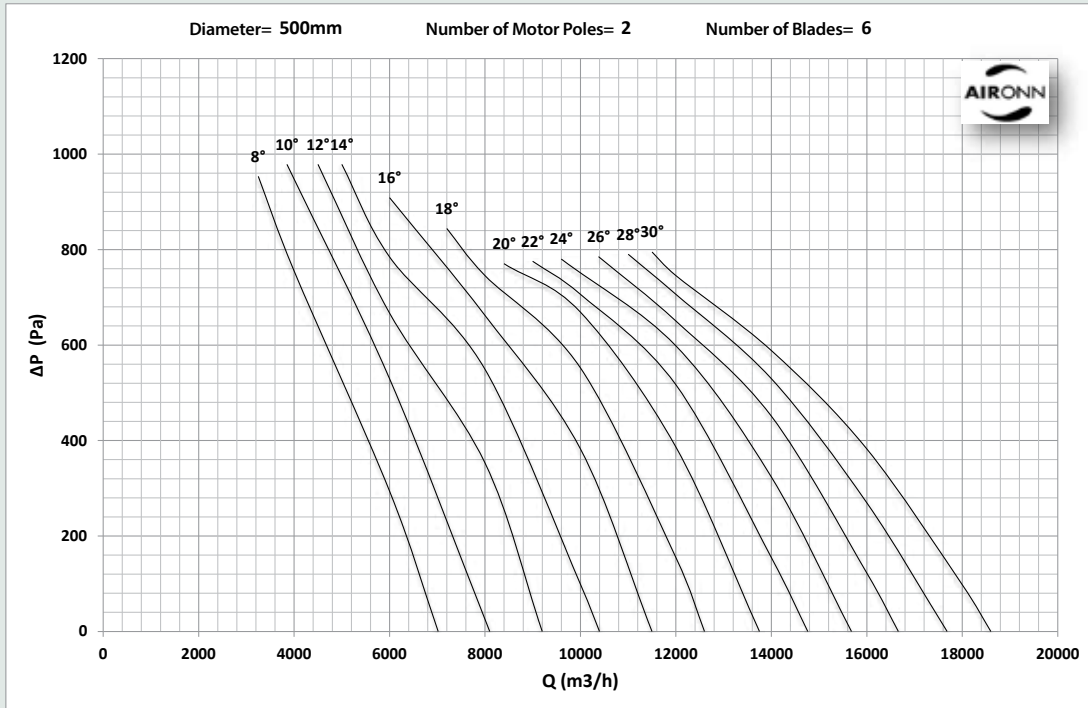

# Cell Type Axial Fresh Air Fan Series

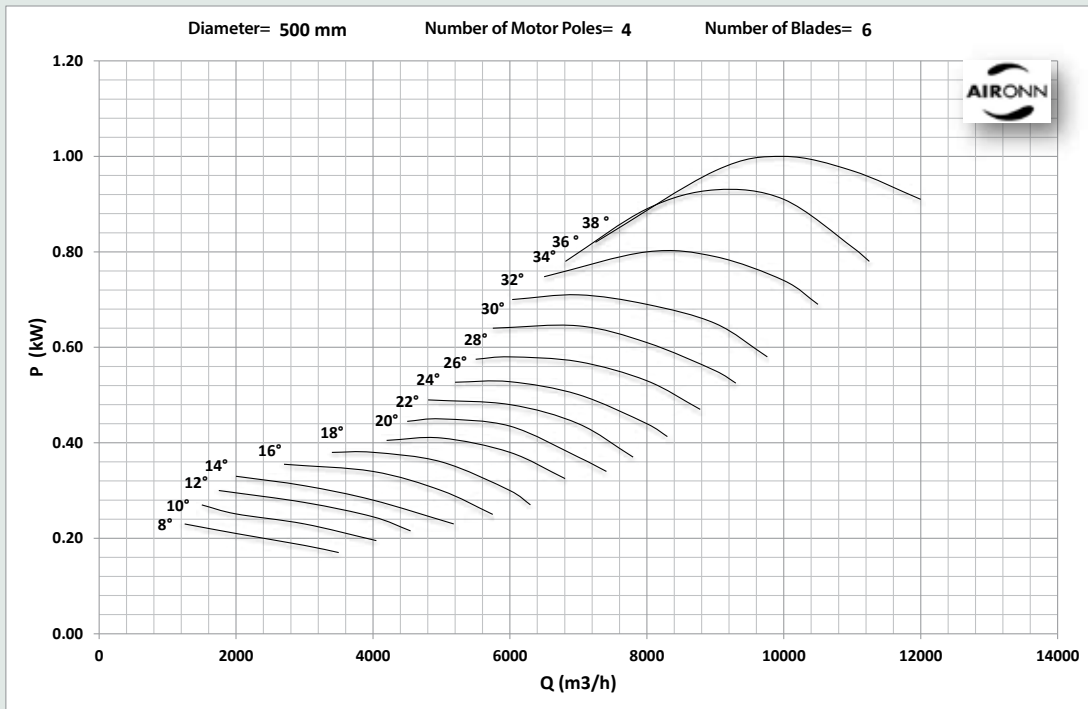
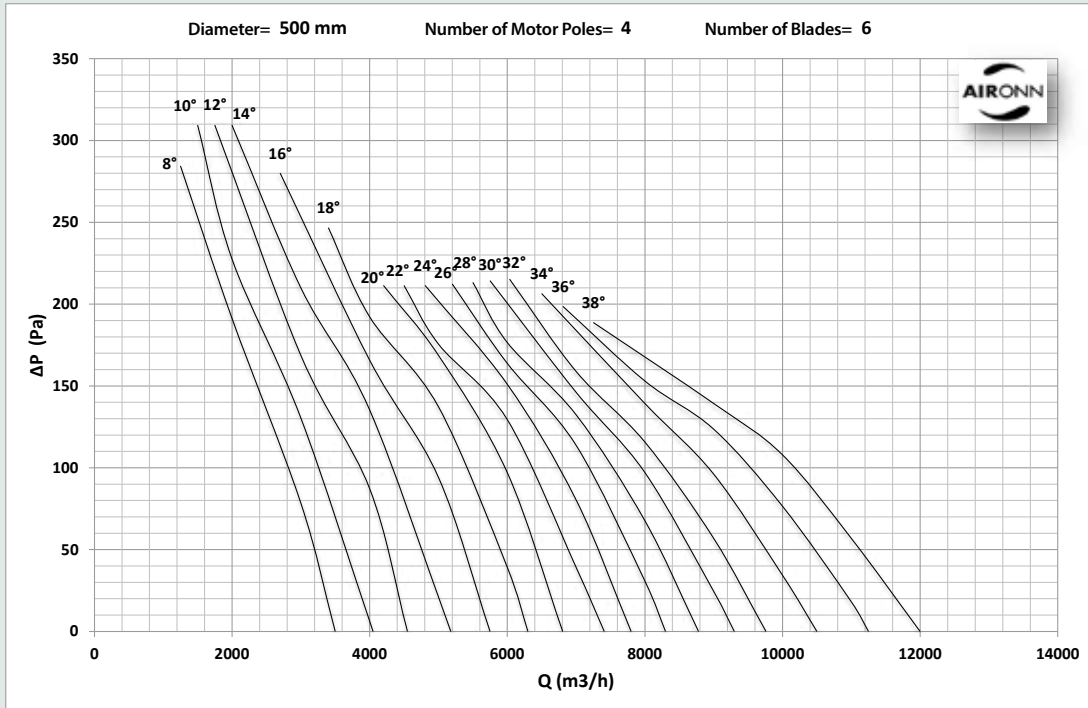

## Cell Type Axial Fresh Air Fan Series

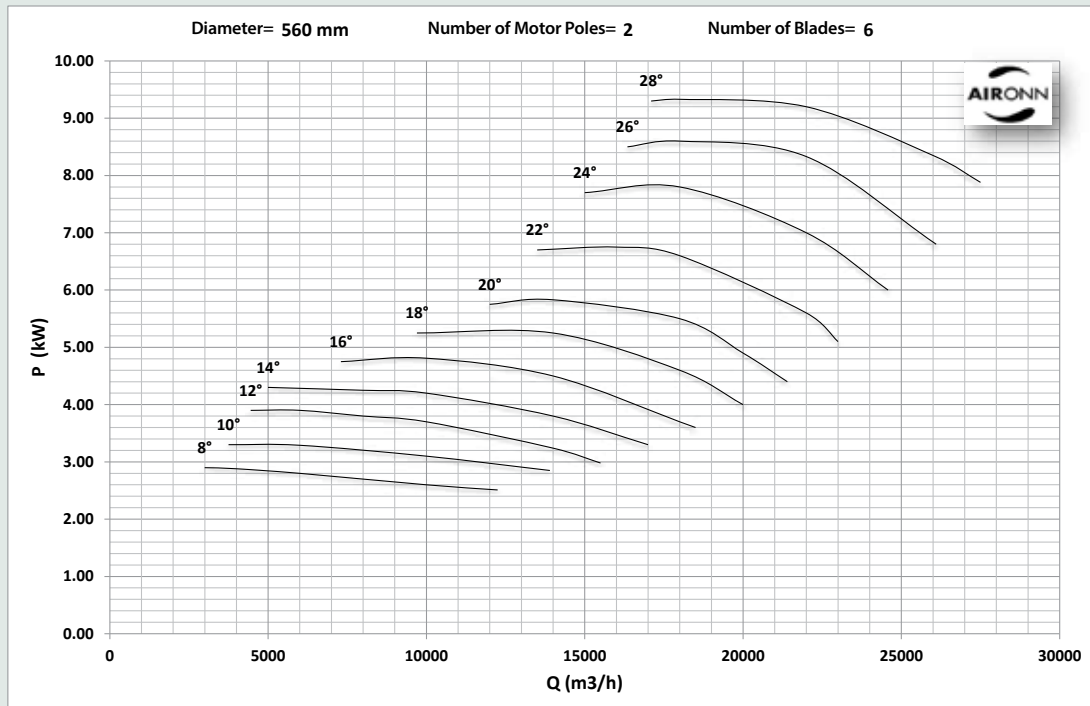
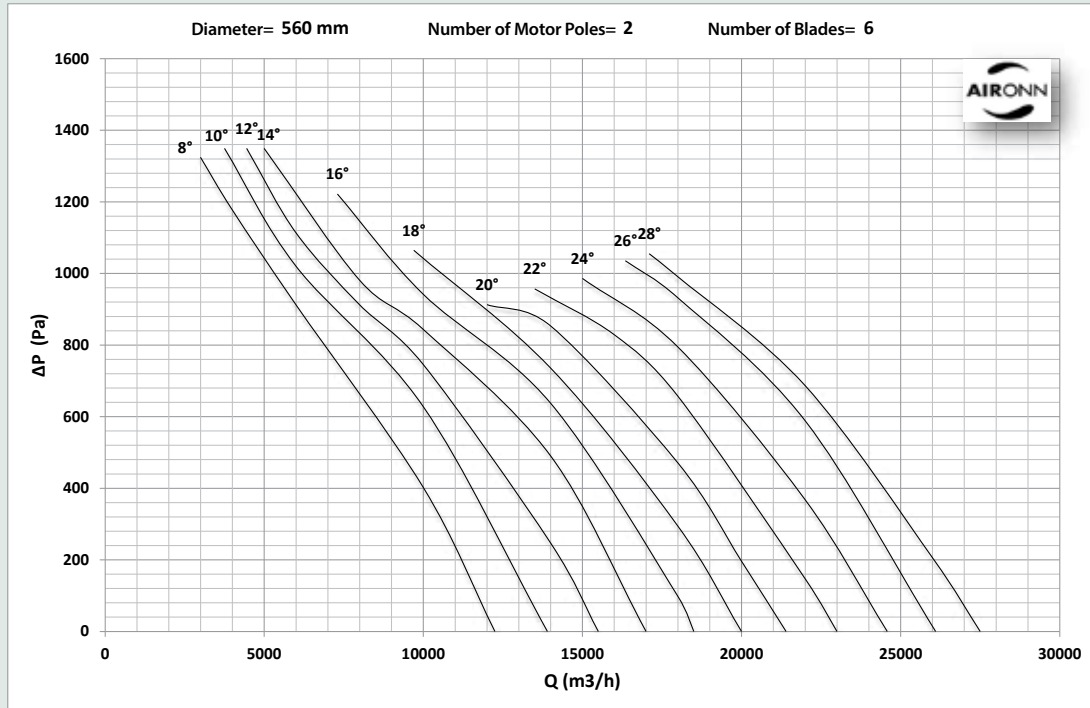

# Cell Type Axial Fresh Air Fan Series

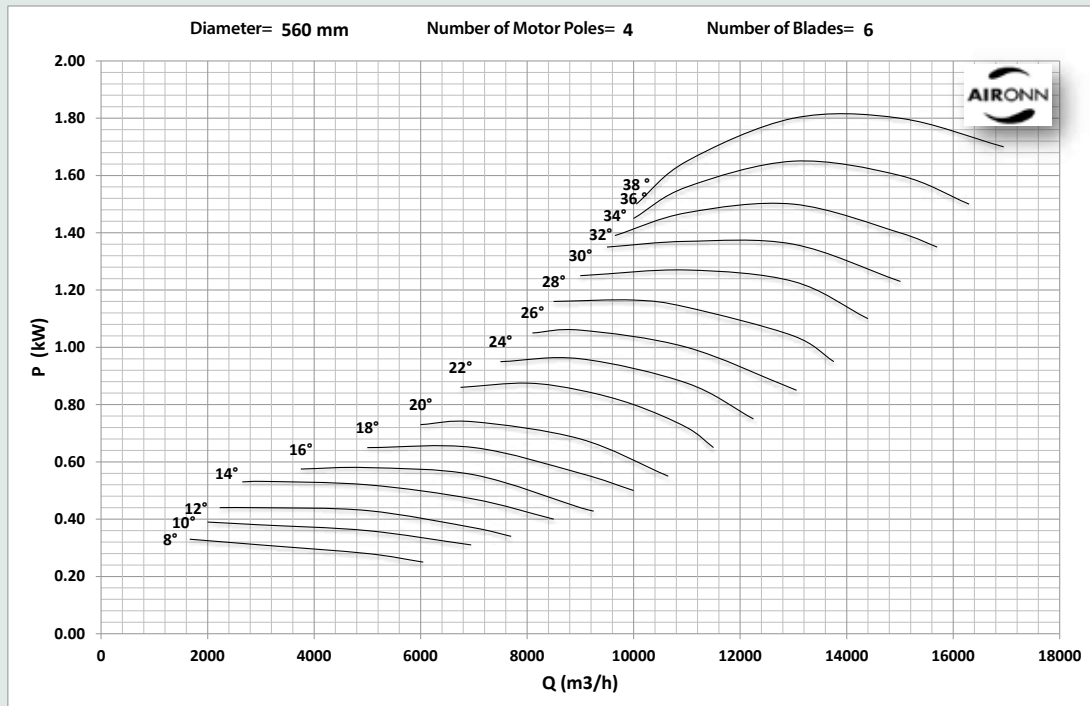
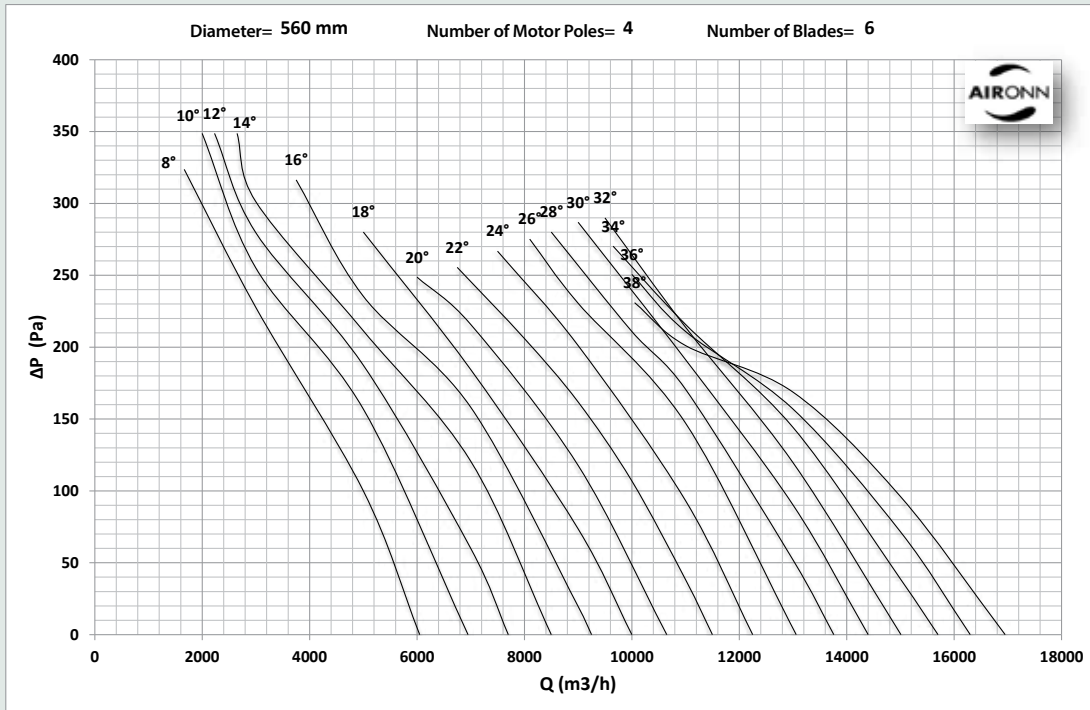



## Cell Type Axial Fresh Air Fan Series

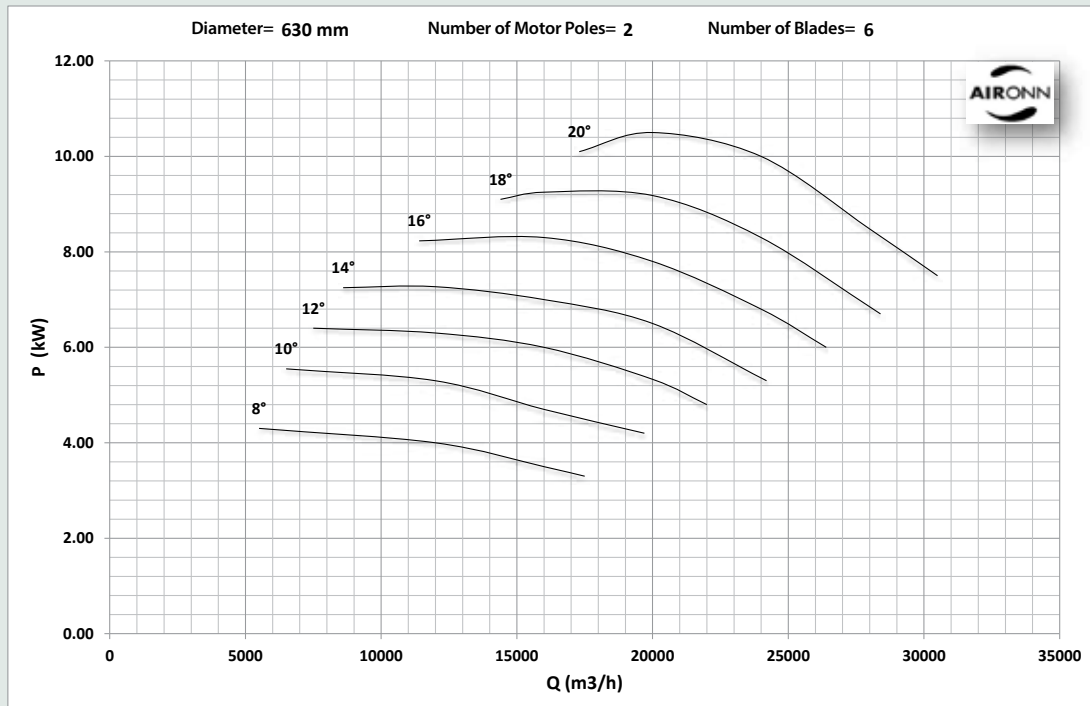
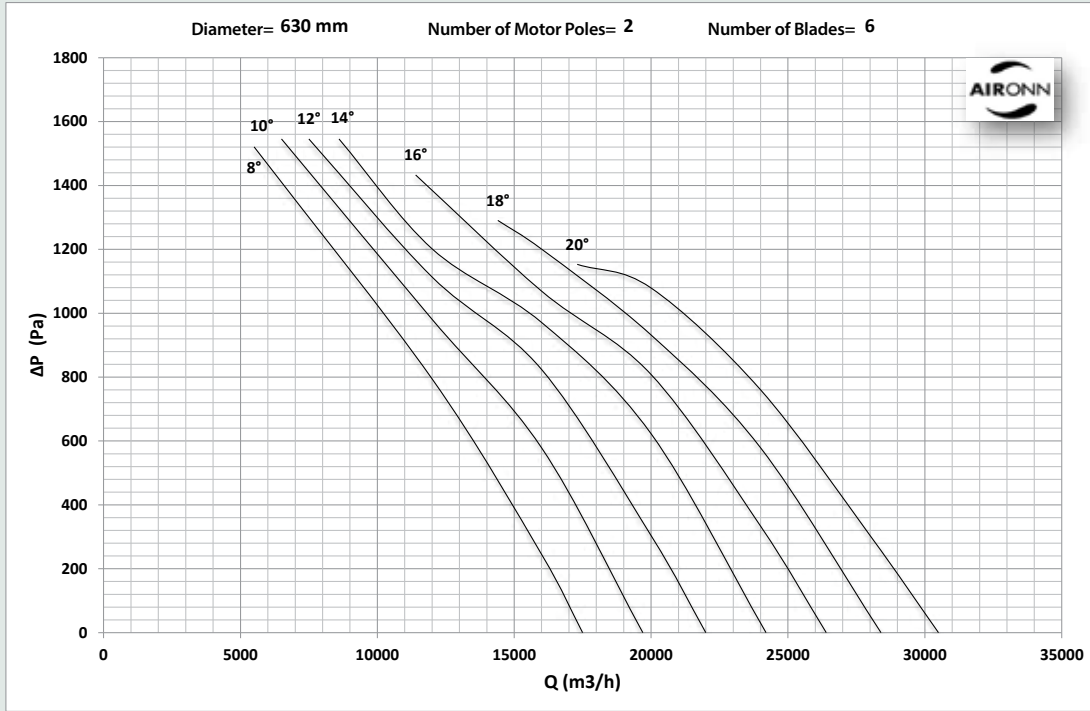

# Cell Type Axial Fresh Air Fan Series

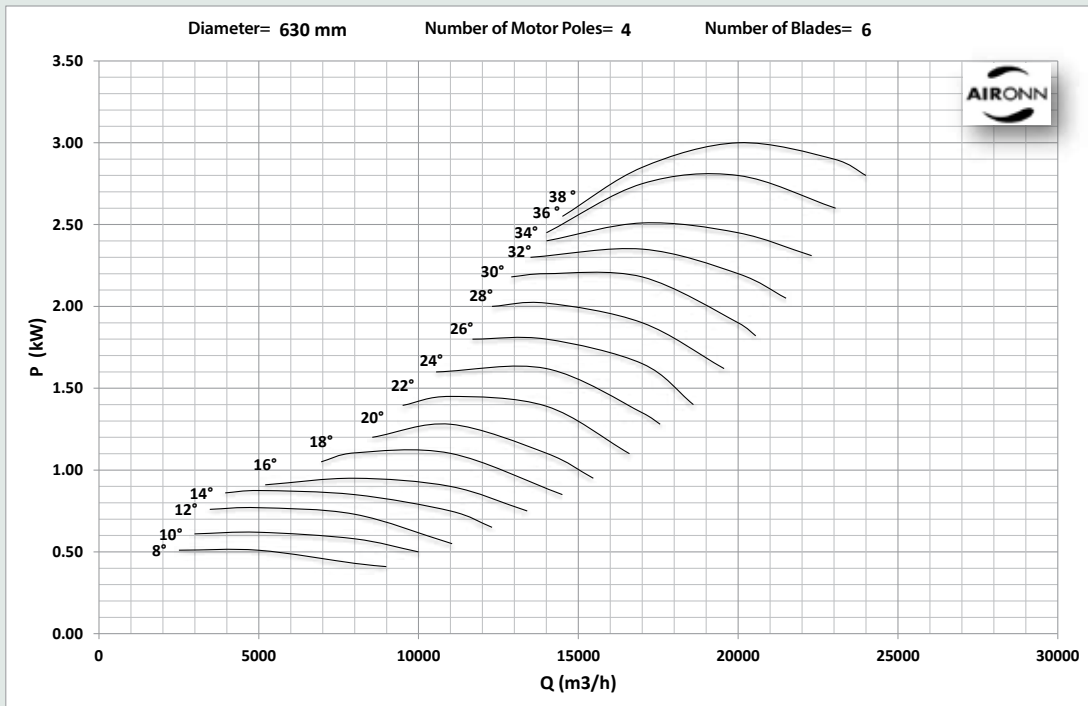
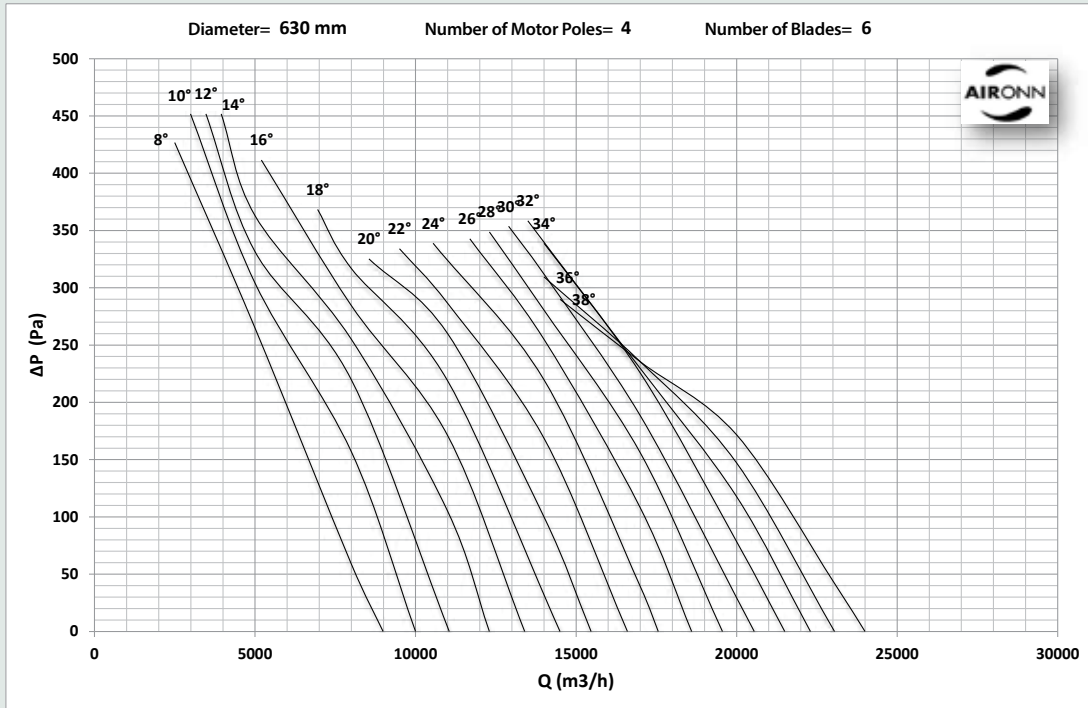

# Cell Type Axial Fresh Air Fan Series

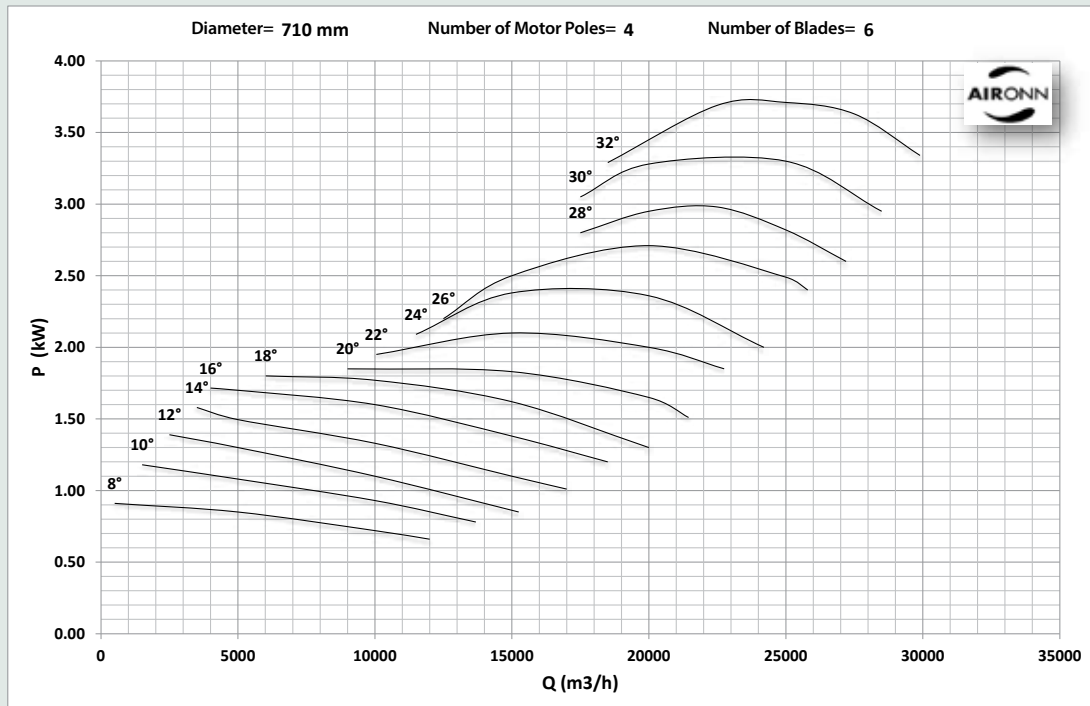
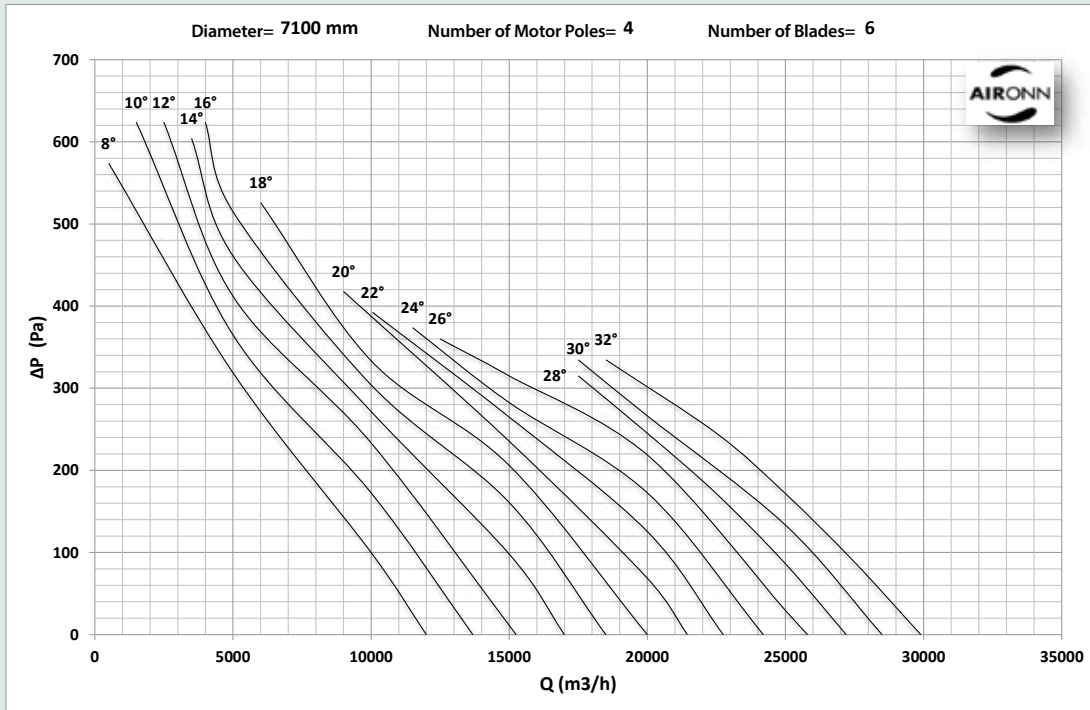

# Cell Type Axial Fresh Air Fan Series

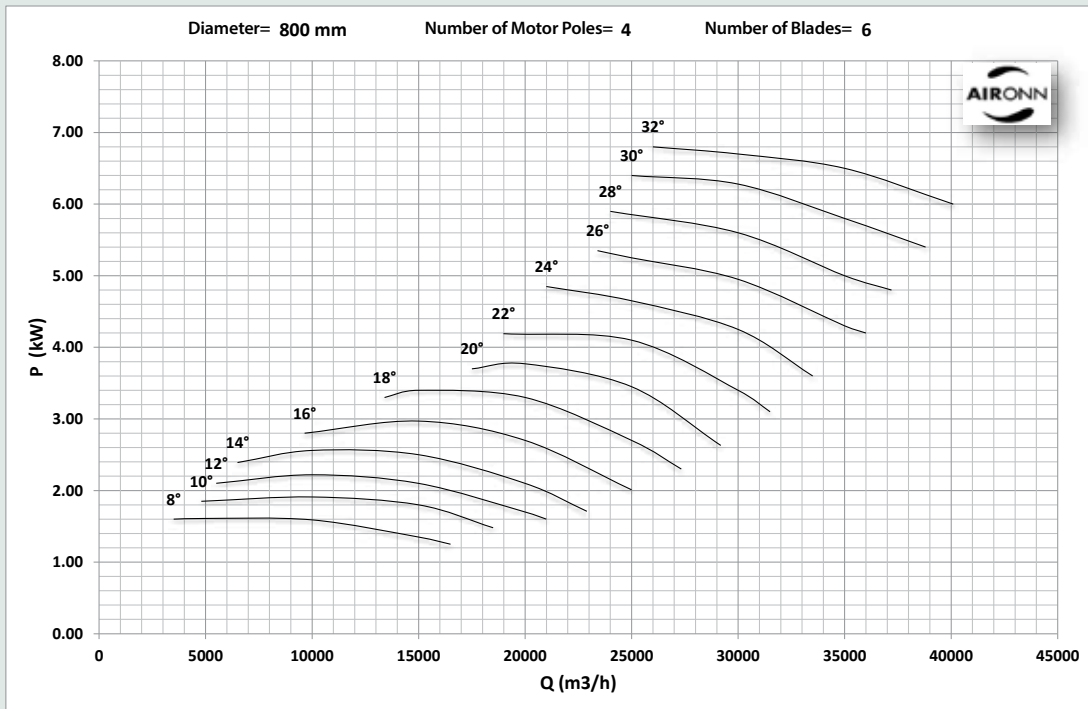
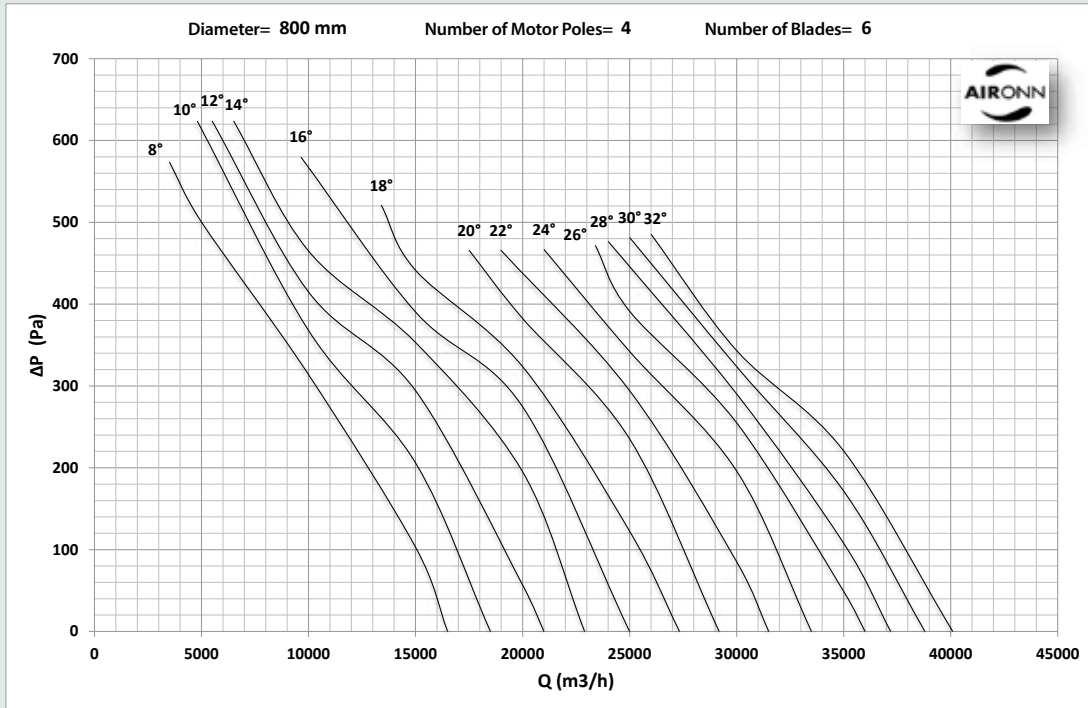

# Cell Type Axial Fresh Air Fan Series

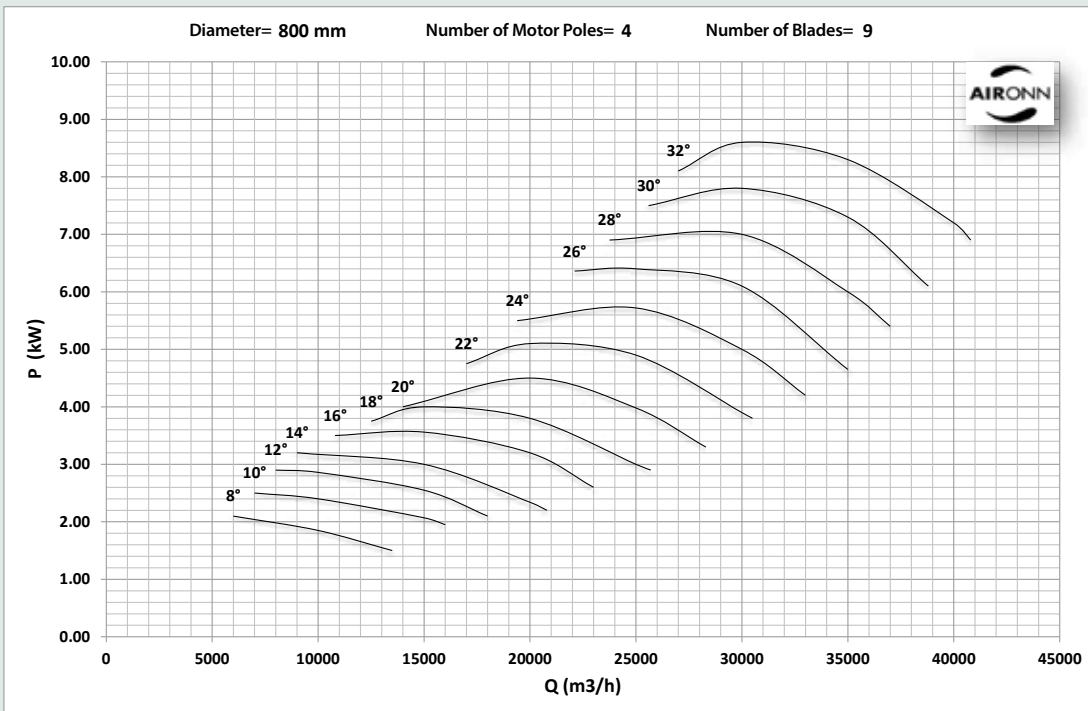
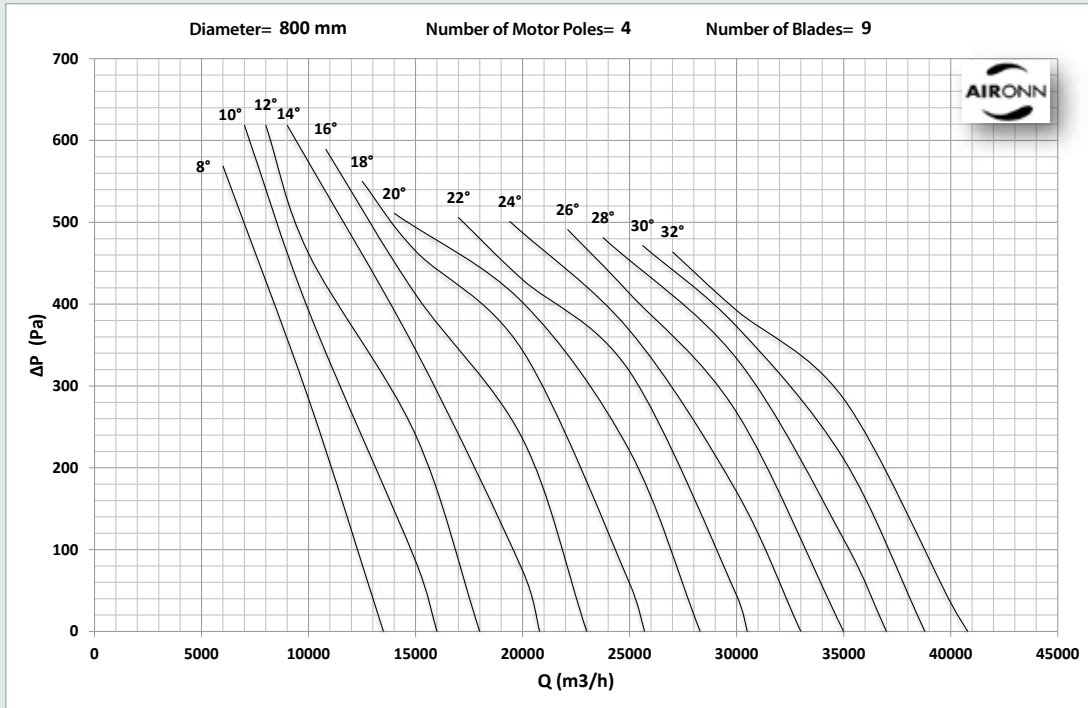

# Cell Type Axial Fresh Air Fan Series

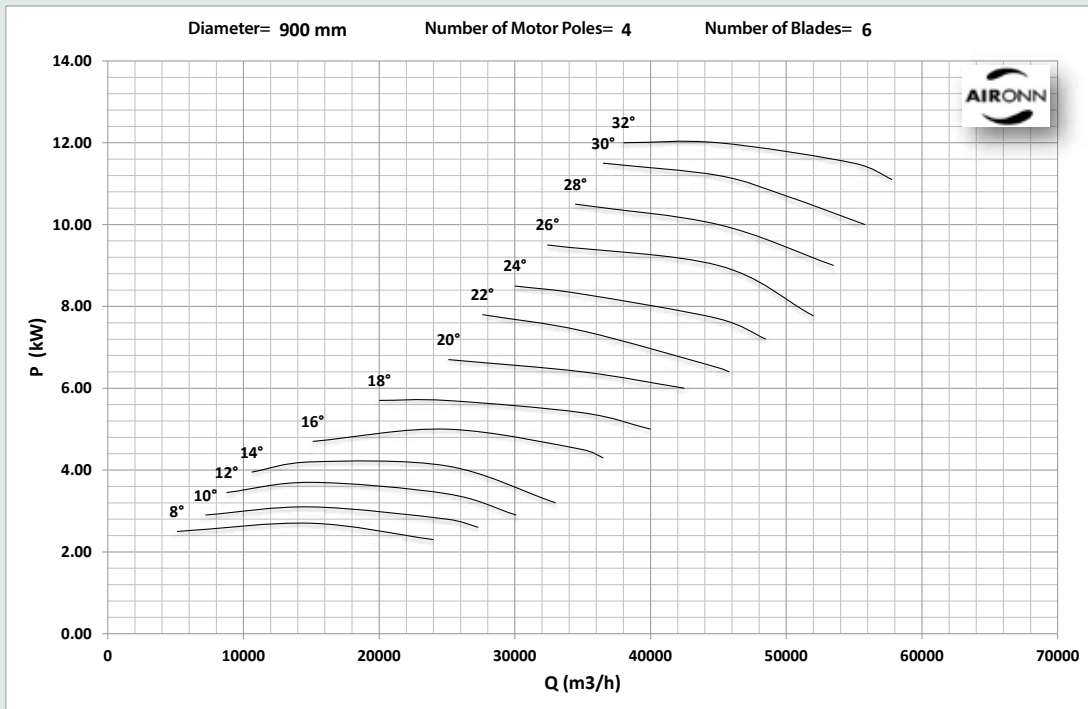
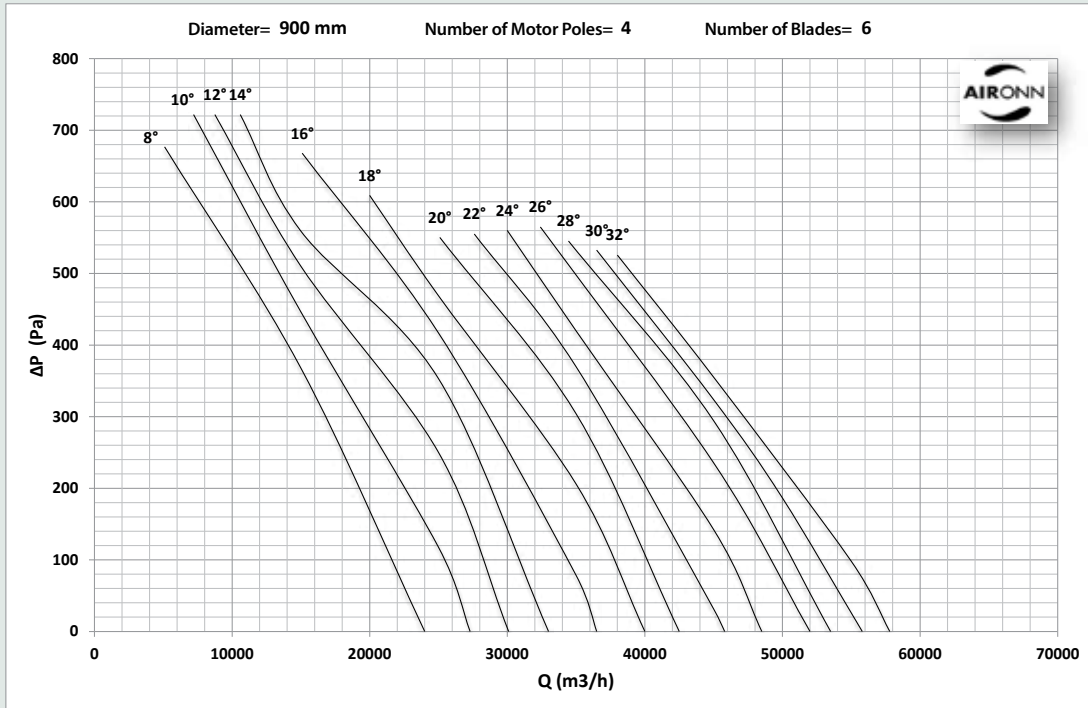

# Cell Type Axial Fresh Air Fan Series

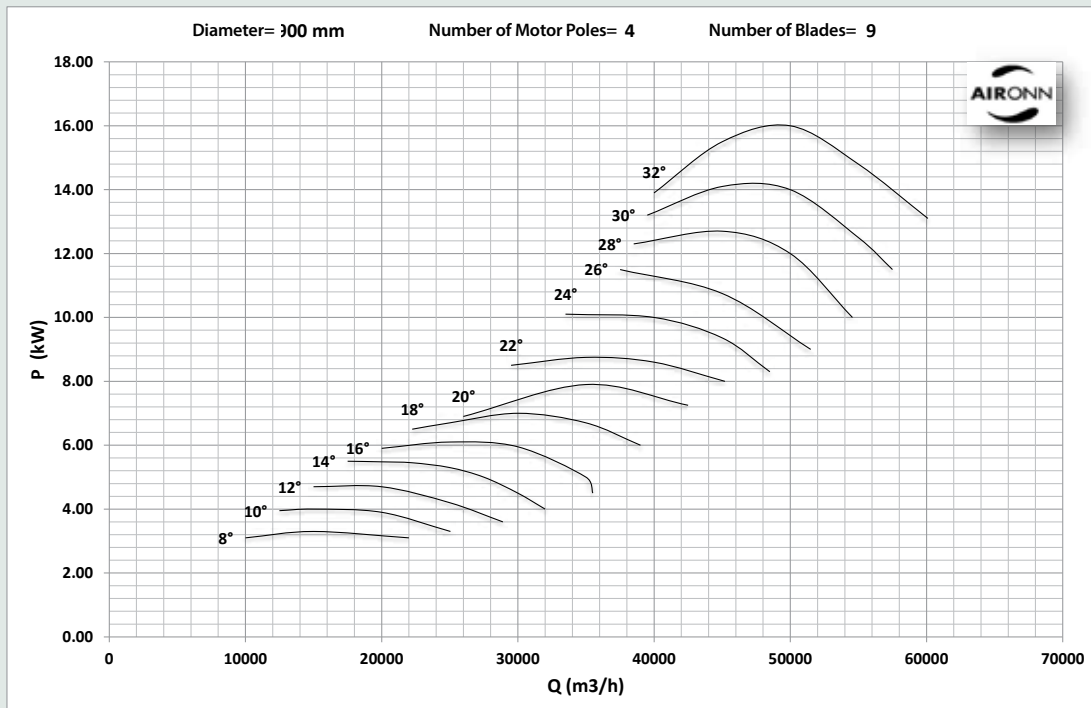
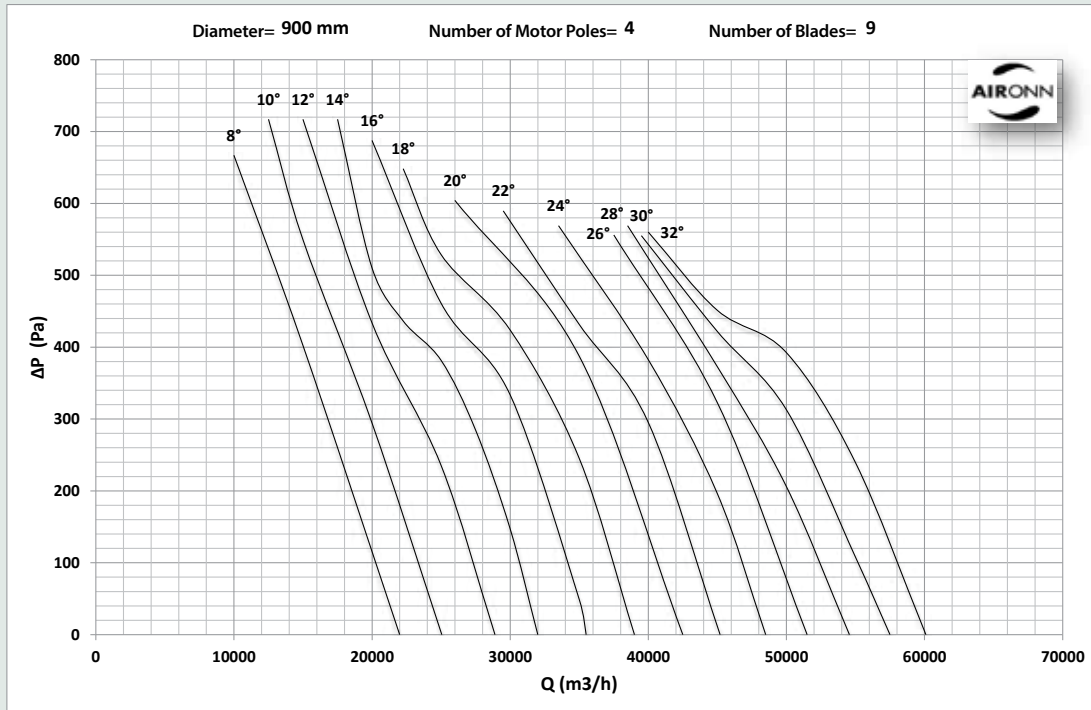

## Cell Type Axial Fresh Air Fan Series

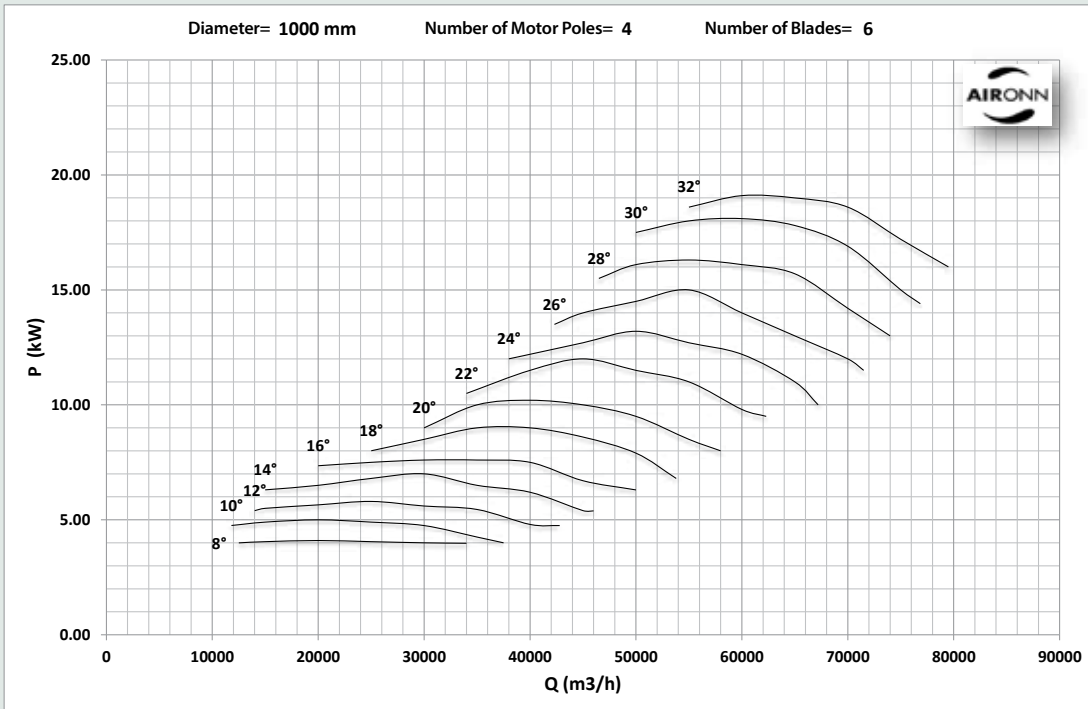
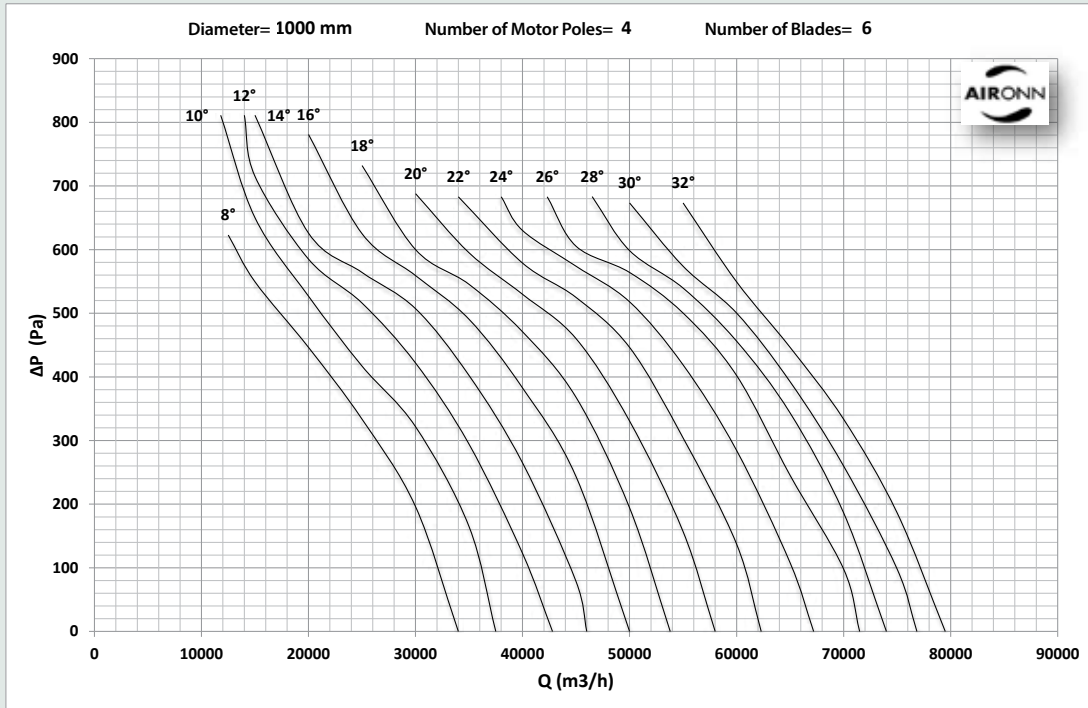



# Cell Type Axial Fresh Air Fan Series

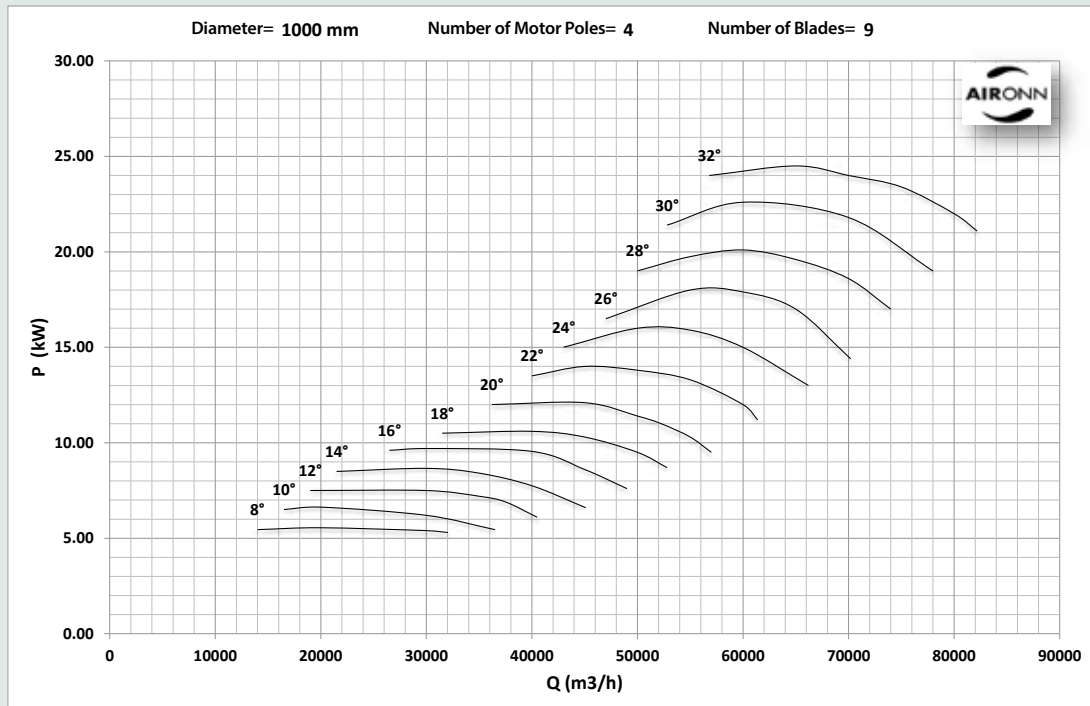
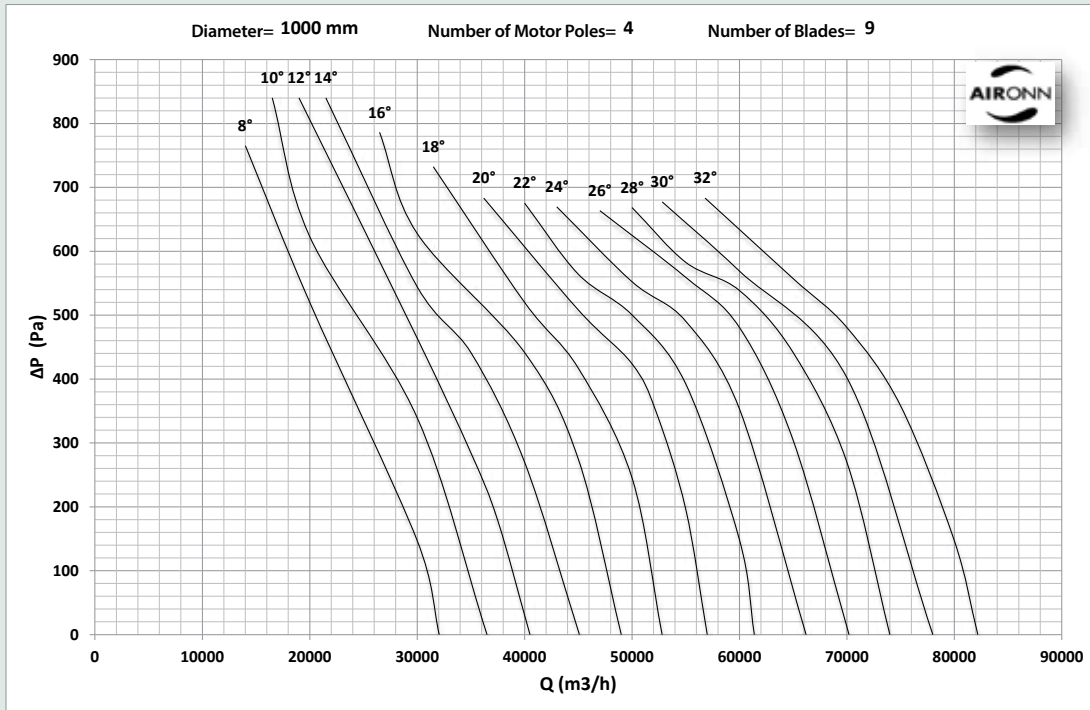

## Cell Type Axial Fresh Air Fan Series

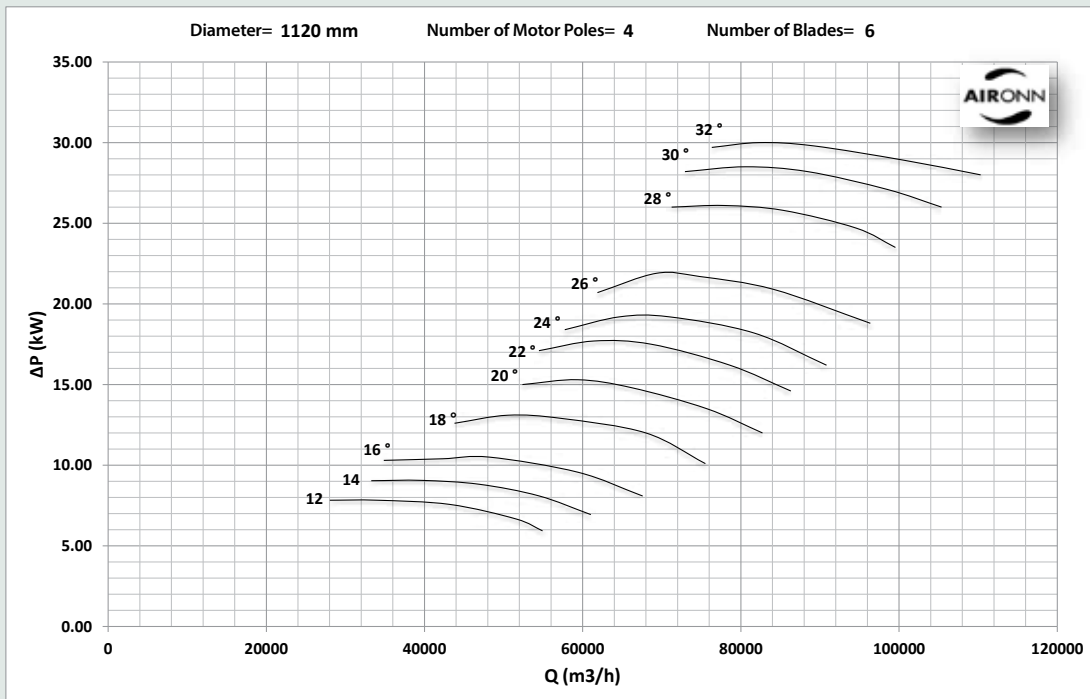
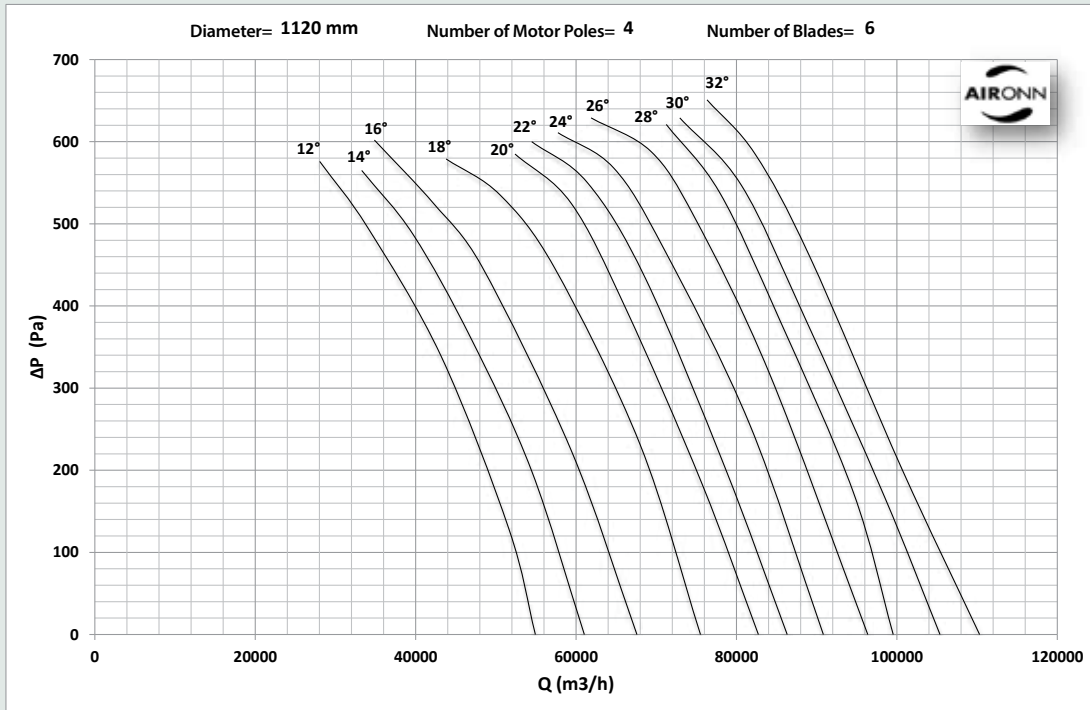

# Cell Type Axial Fresh Air Fan Series

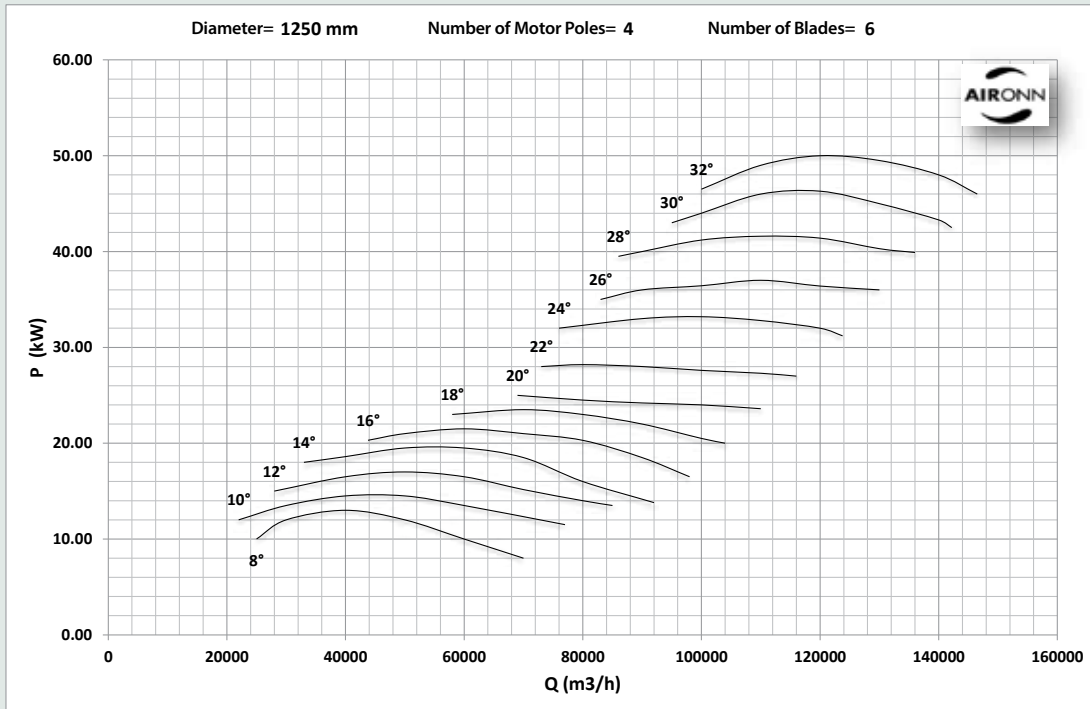
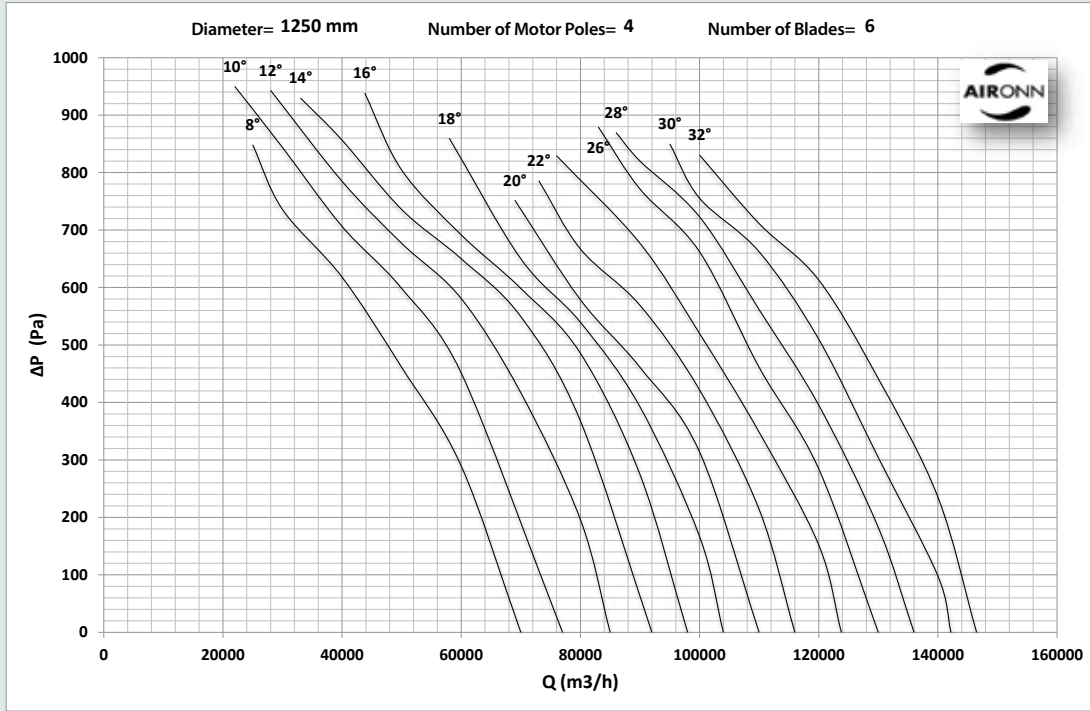

# Cell Type Axial Fresh Air Fan Series

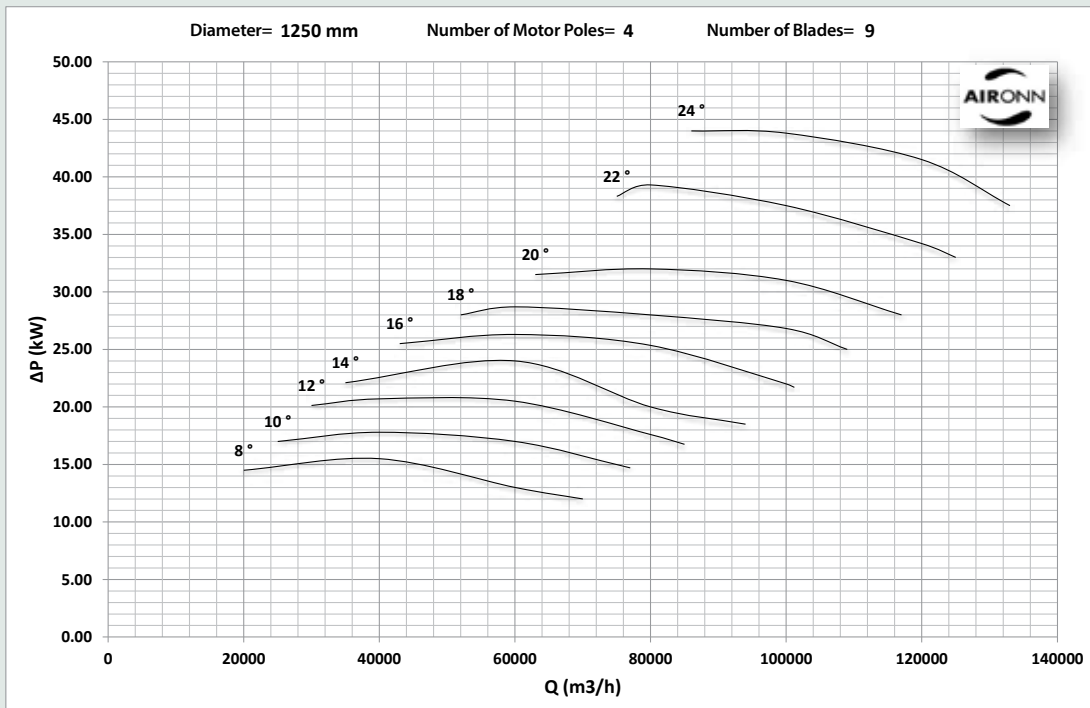
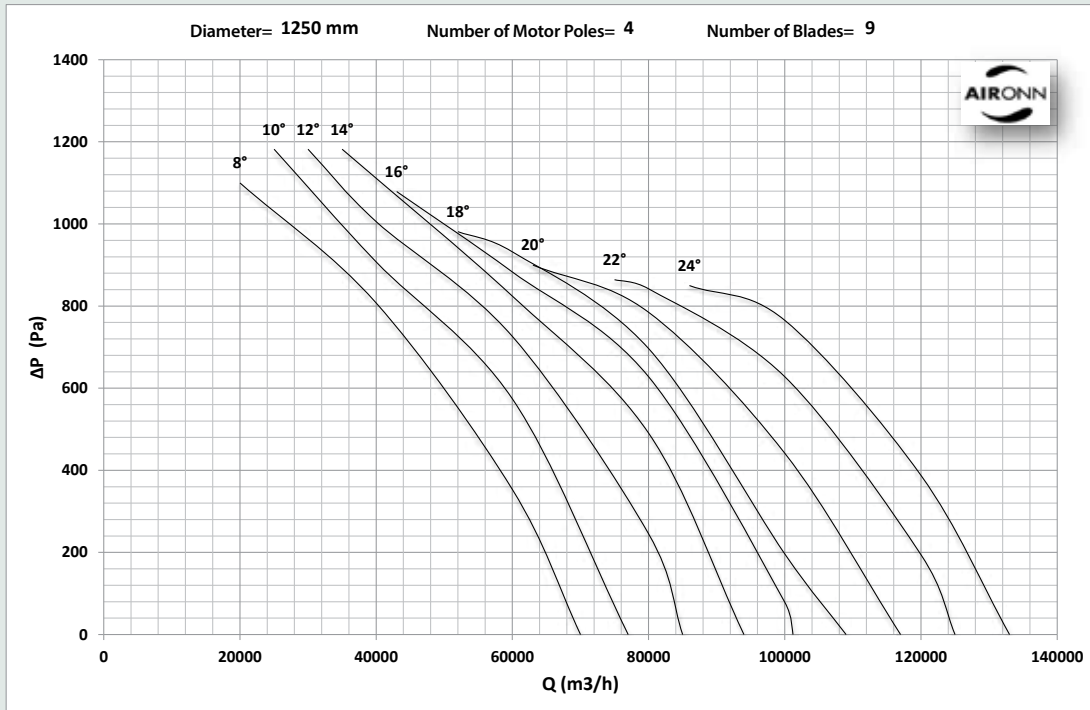

# Cell Type Axial Smoke Exhaust Fan Series

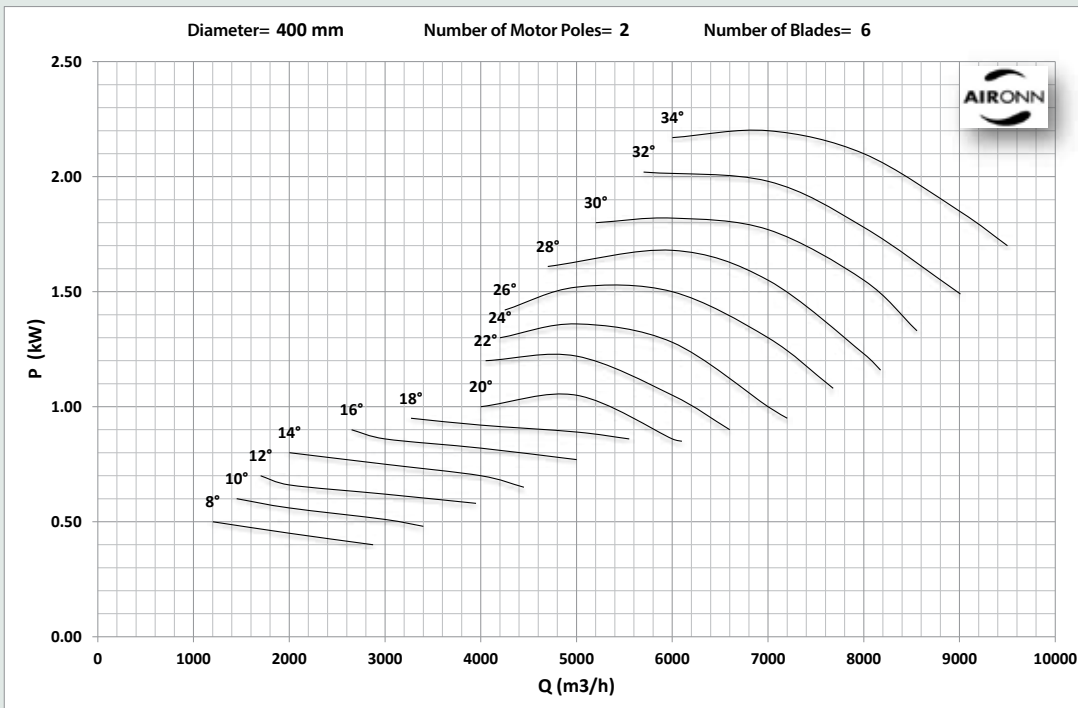
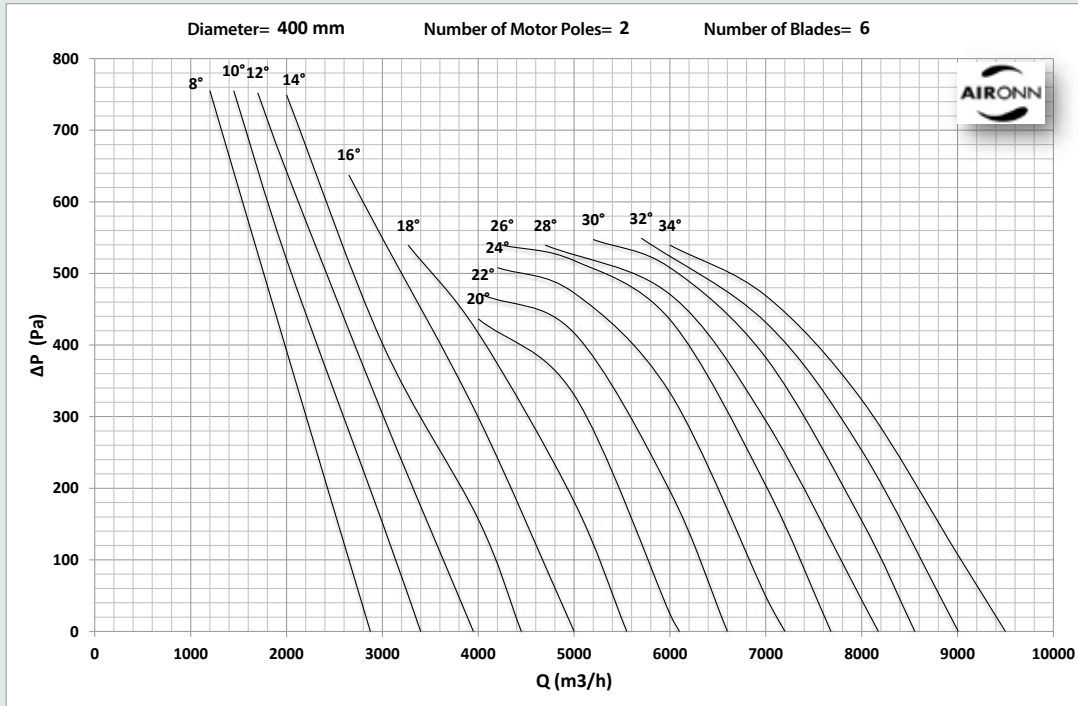

# Cell Type Axial Smoke Exhaust Fan Series

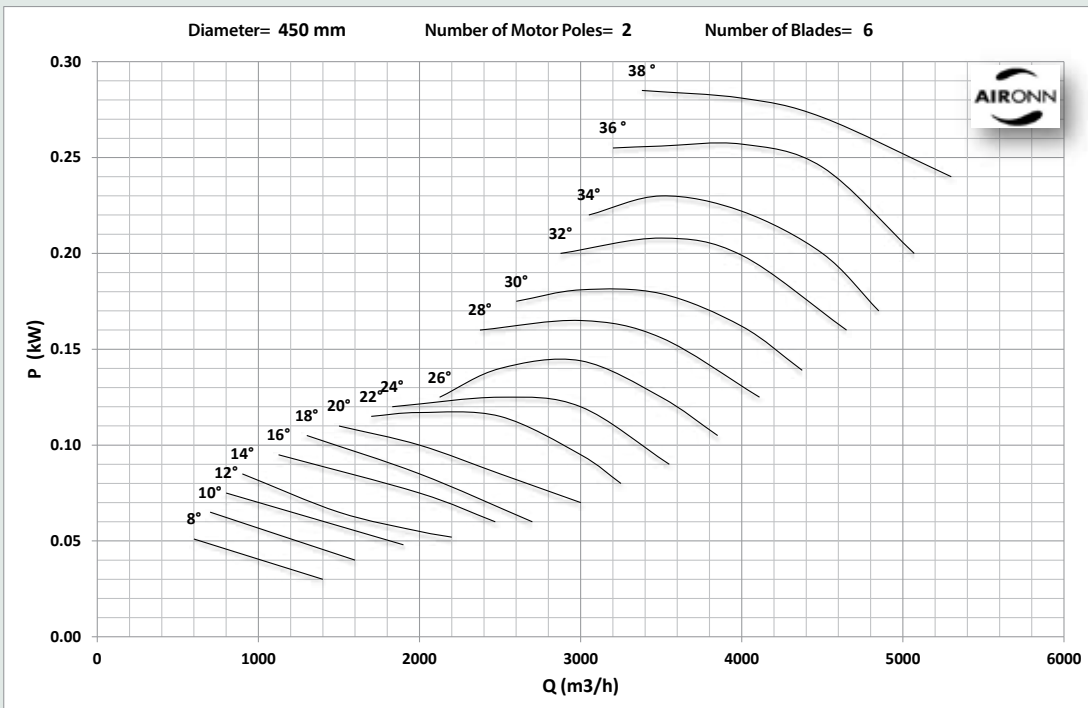
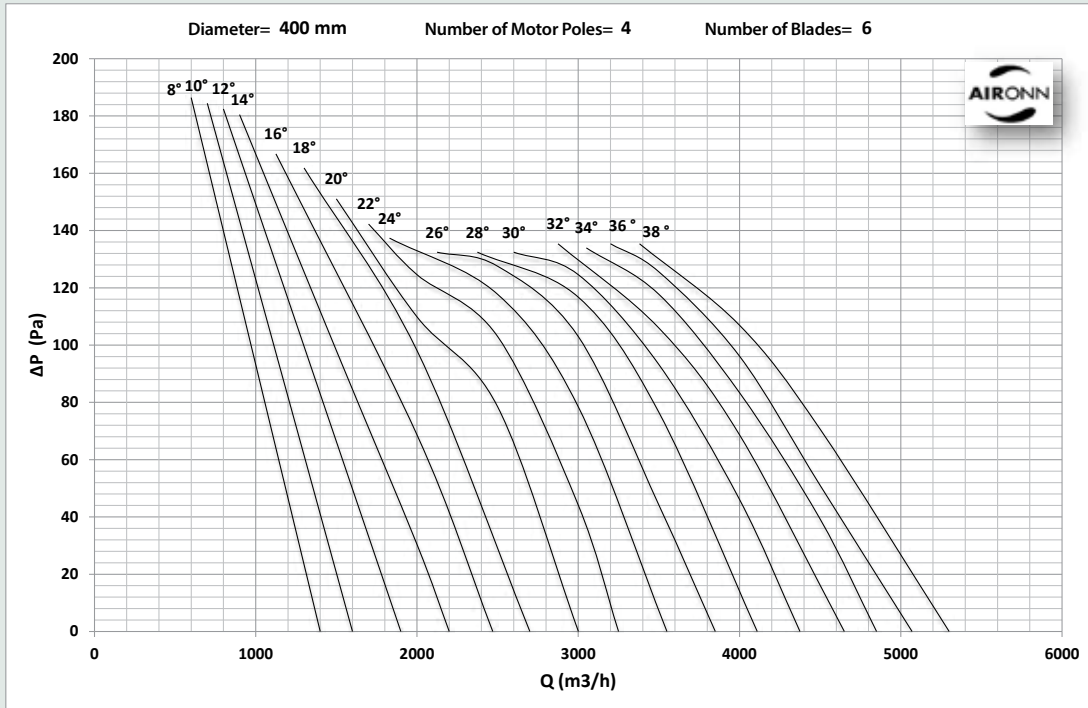

# Cell Type Axial Smoke Exhaust Fan Series

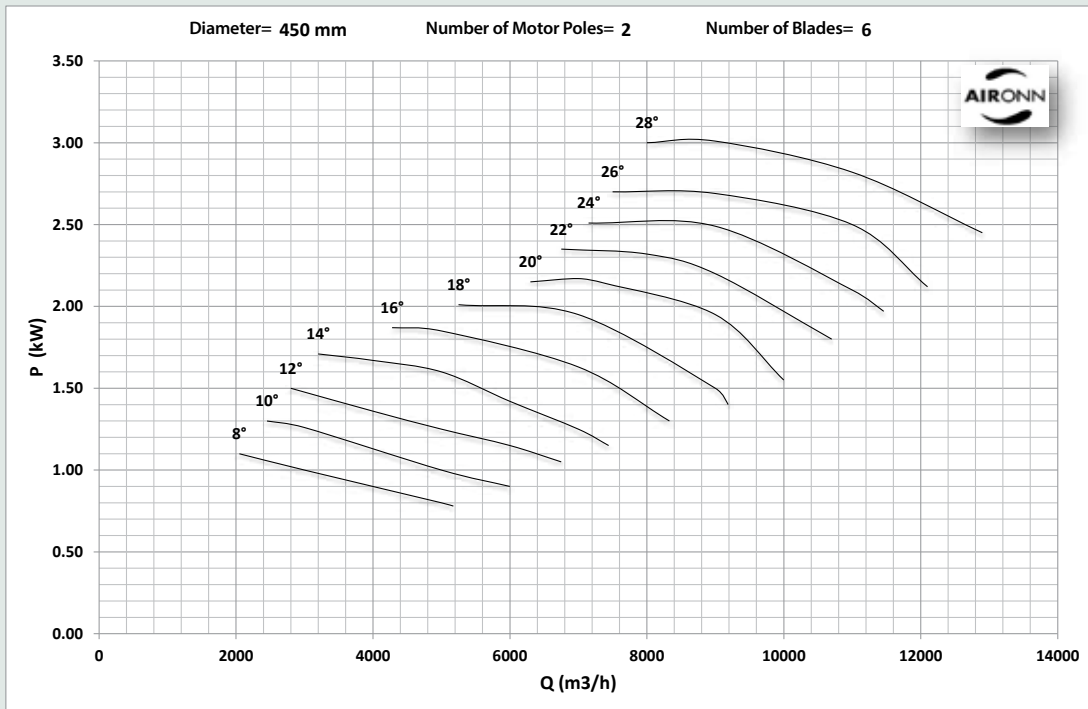
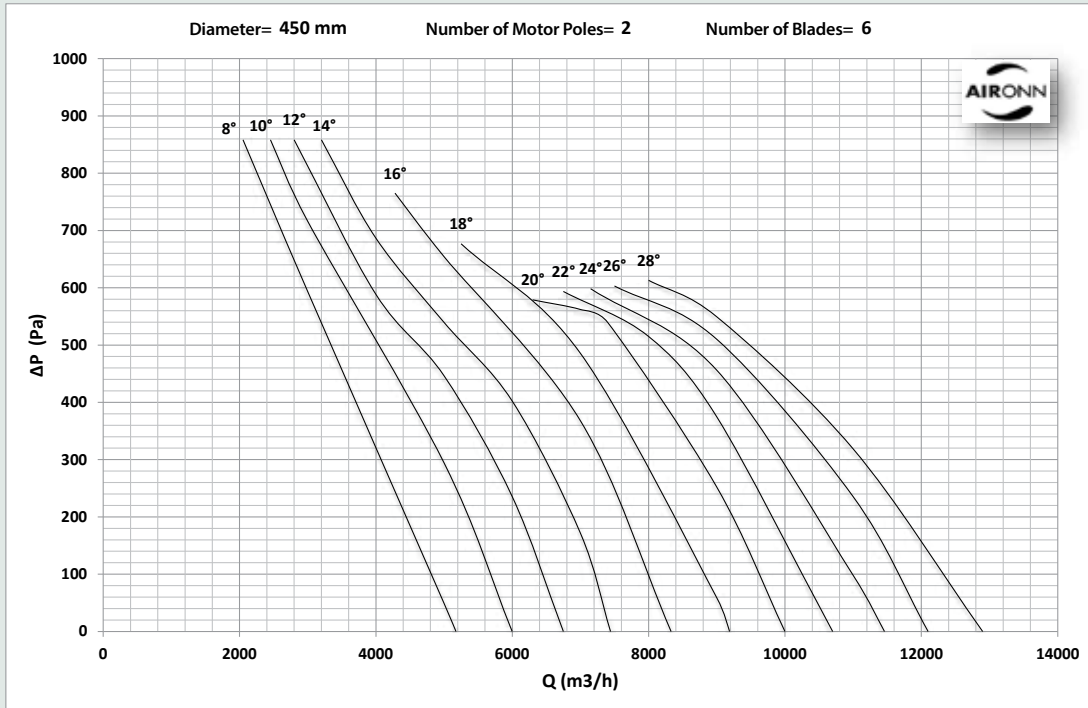

# Cell Type Axial Smoke Exhaust Fan Series

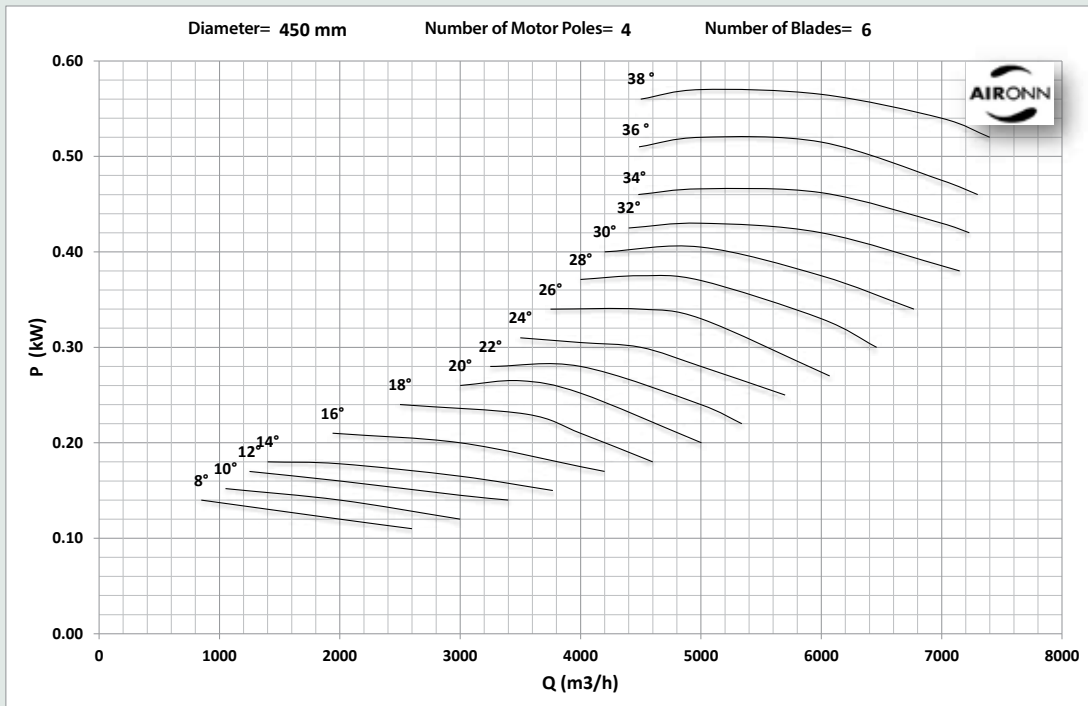
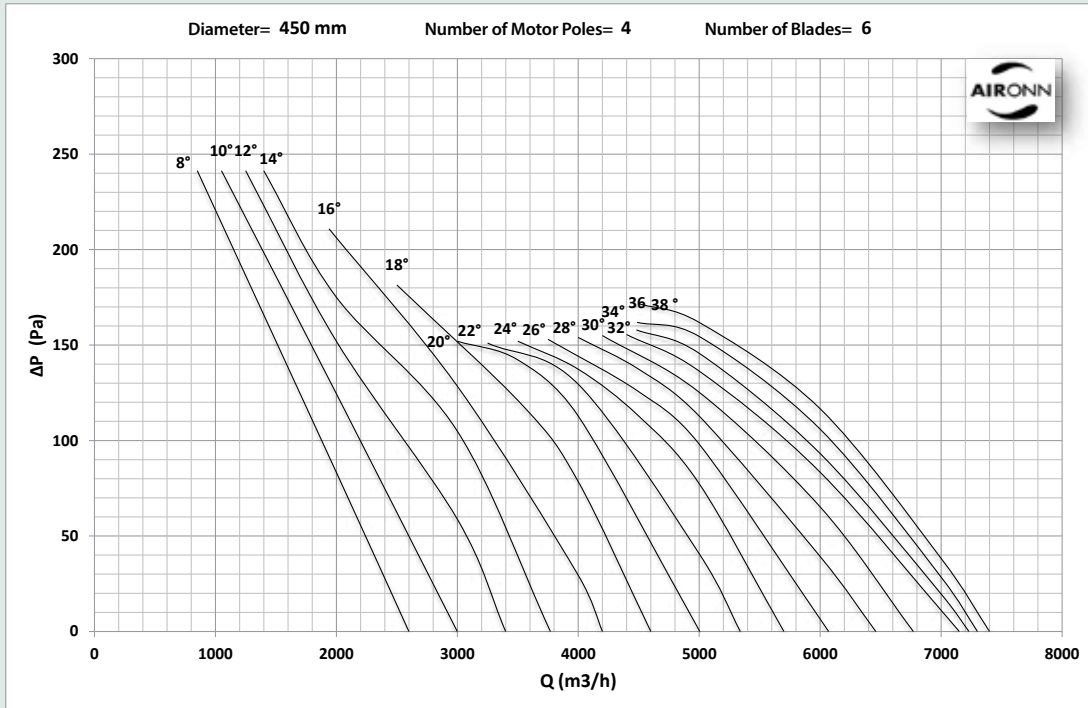



# Cell Type Axial Smoke Exhaust Fan Series

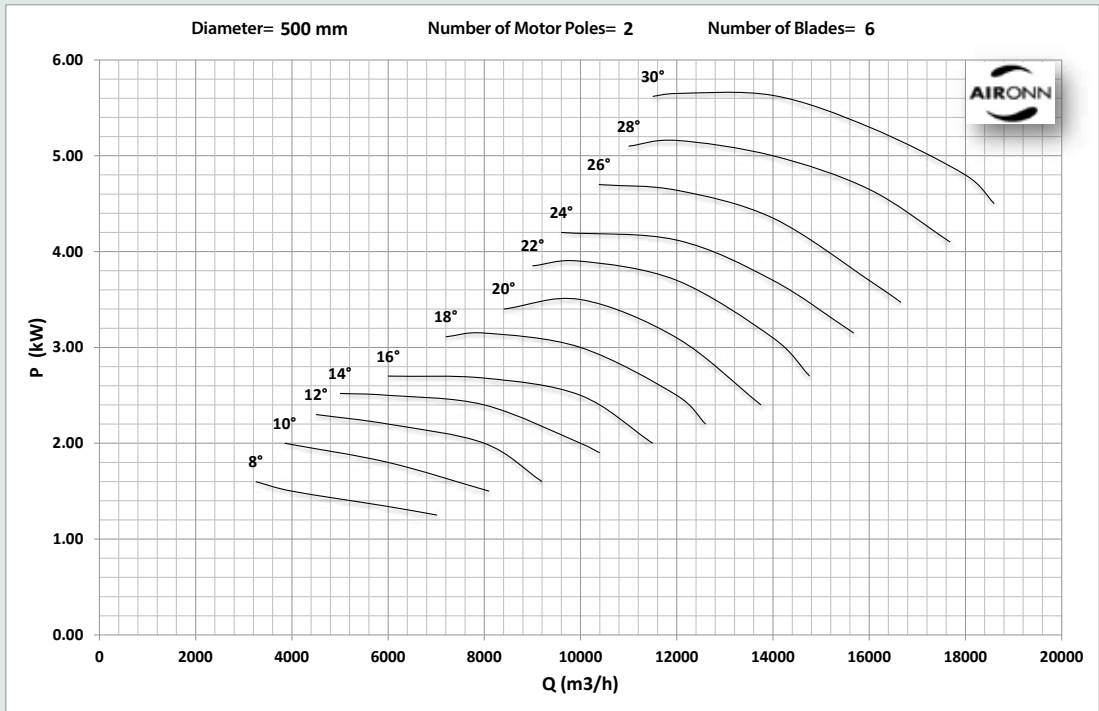
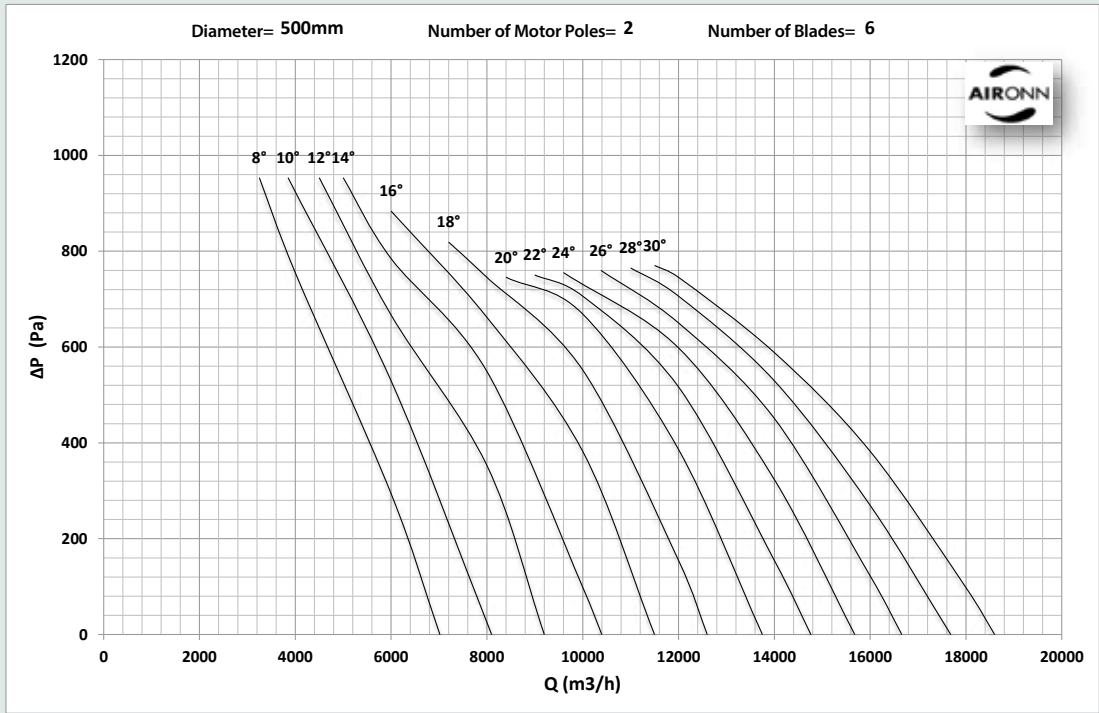

# Cell Type Axial Smoke Exhaust Fan Series

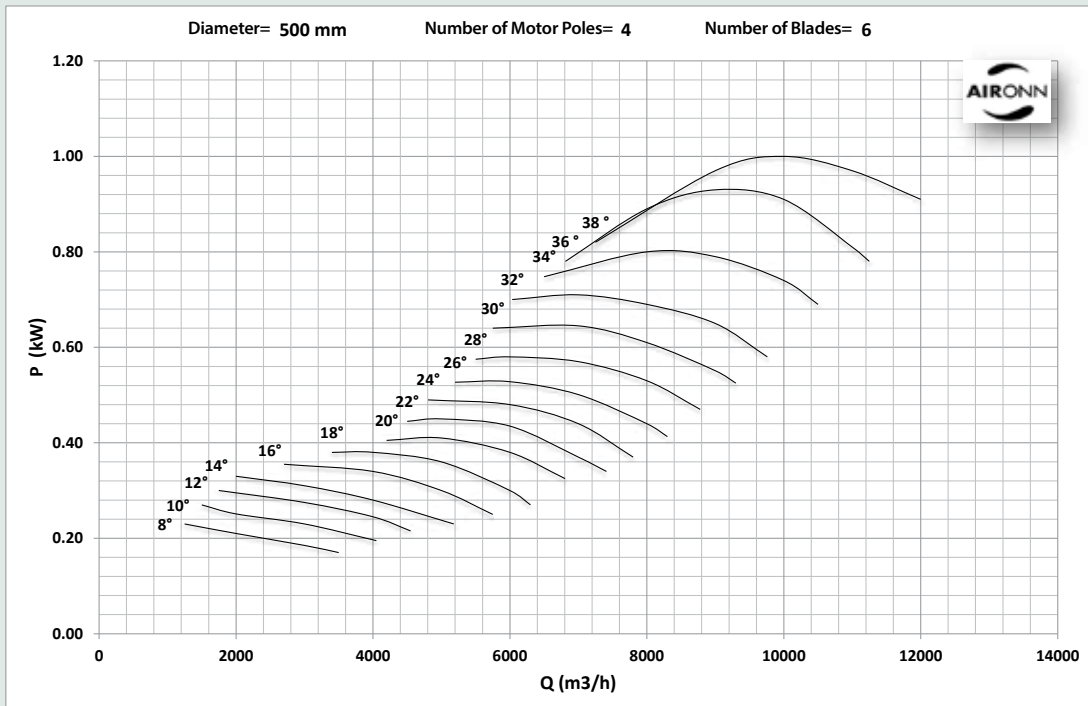
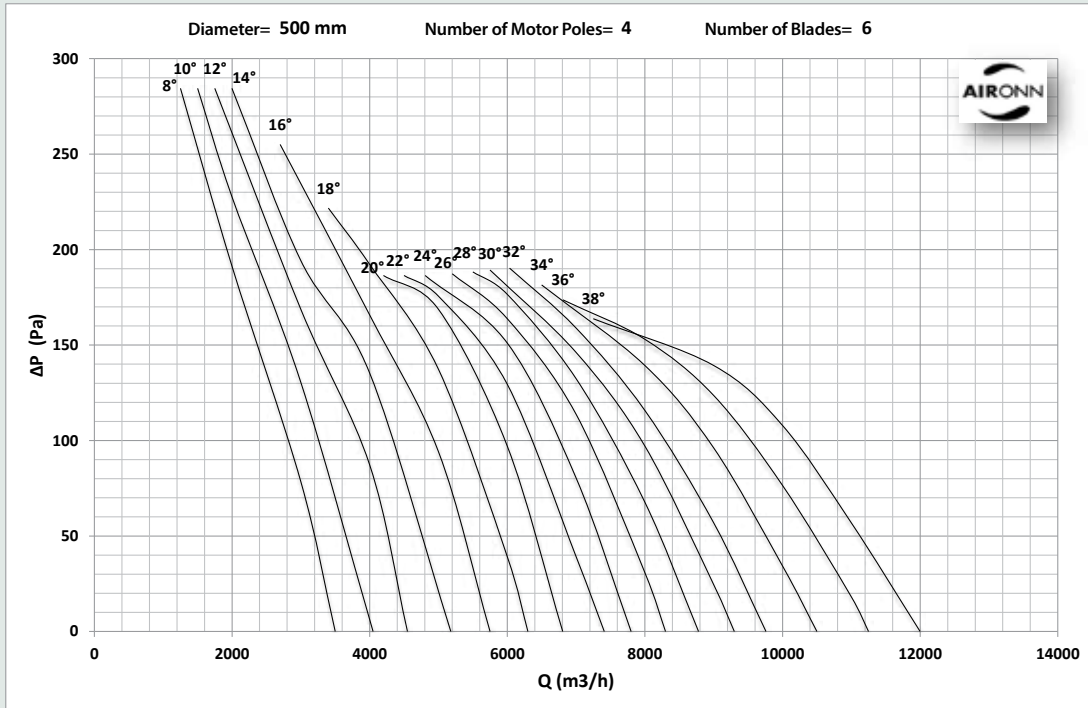

# Cell Type Axial Smoke Exhaust Fan Series

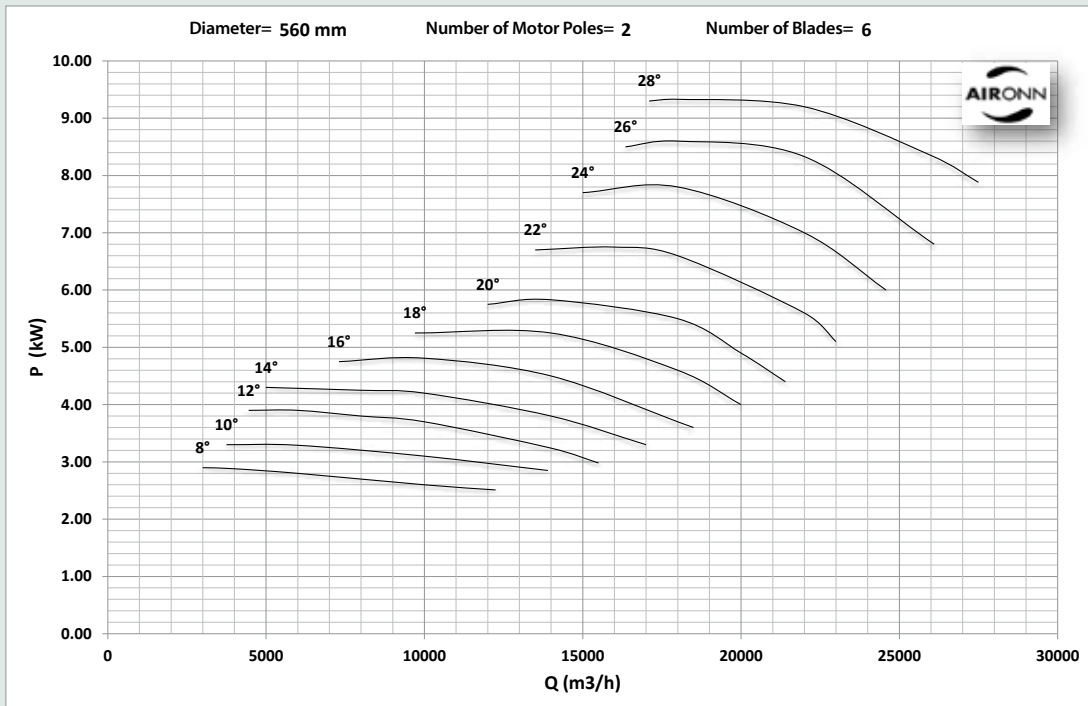
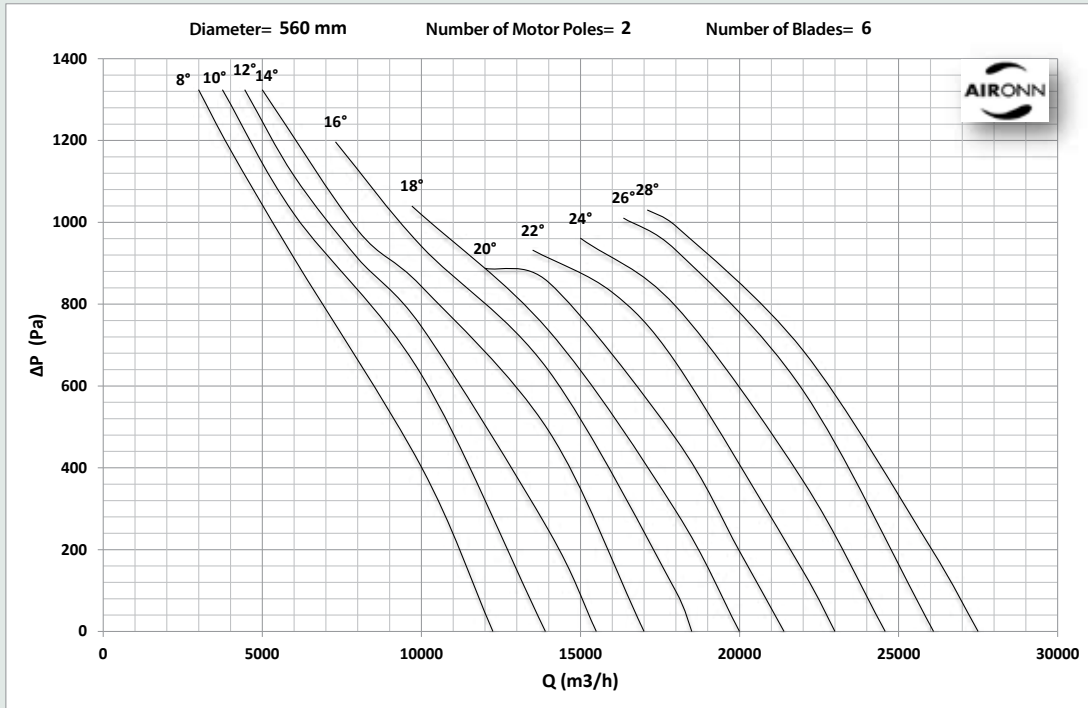

# Cell Type Axial Smoke Exhaust Fan Series

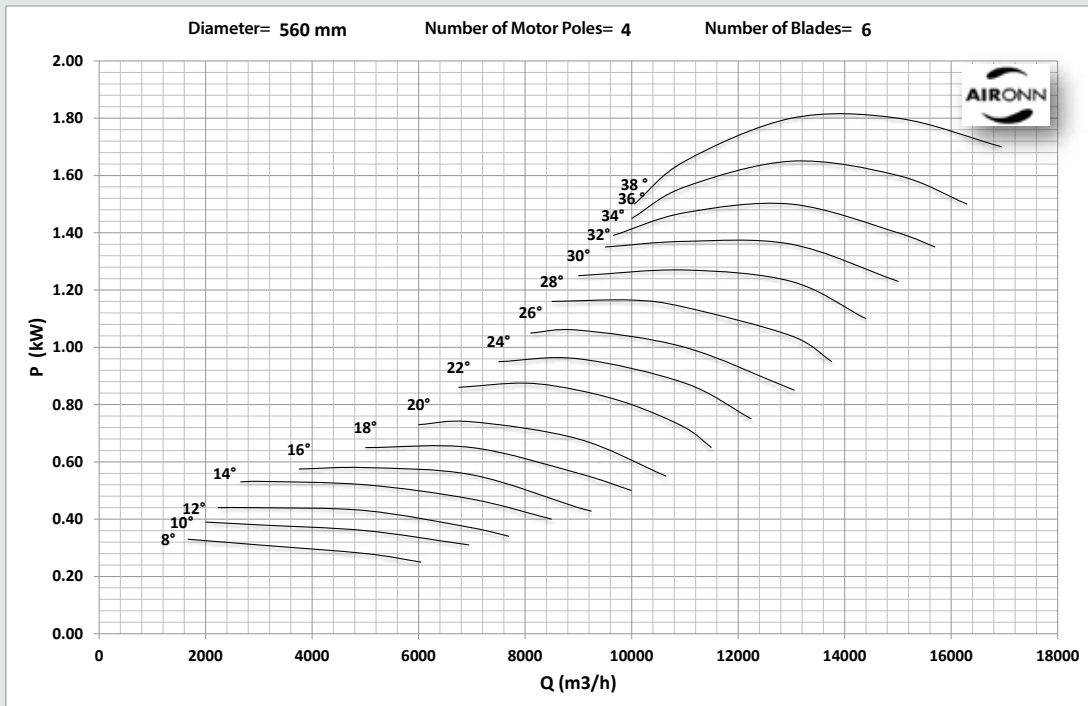
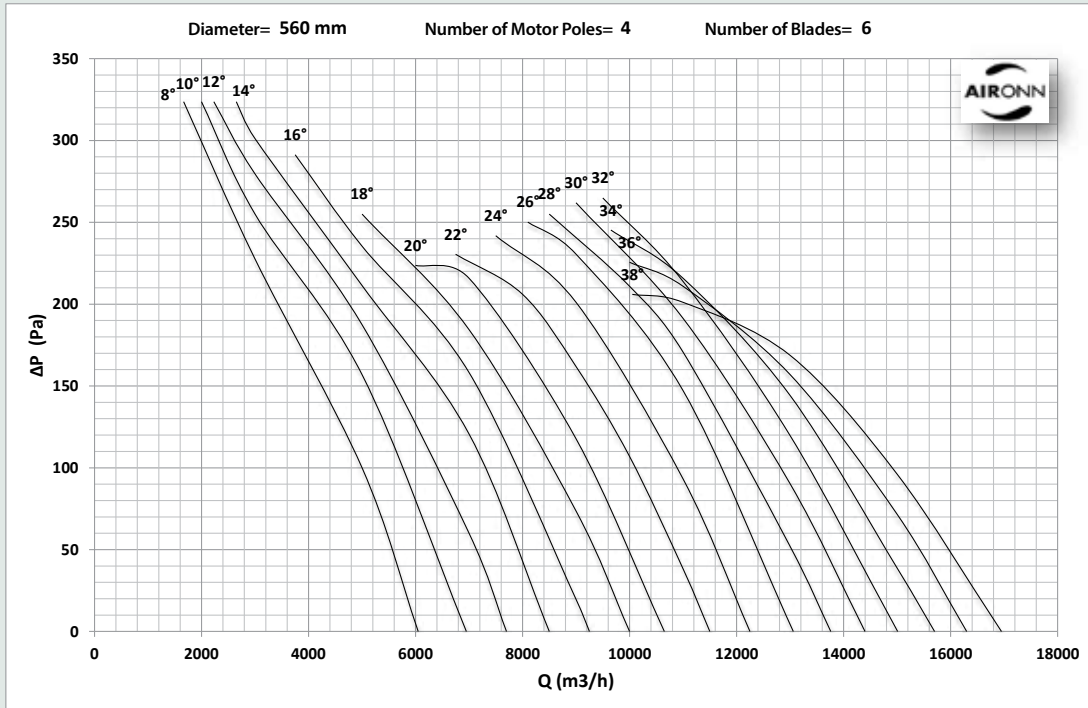

# Cell Type Axial Smoke Exhaust Fan Series

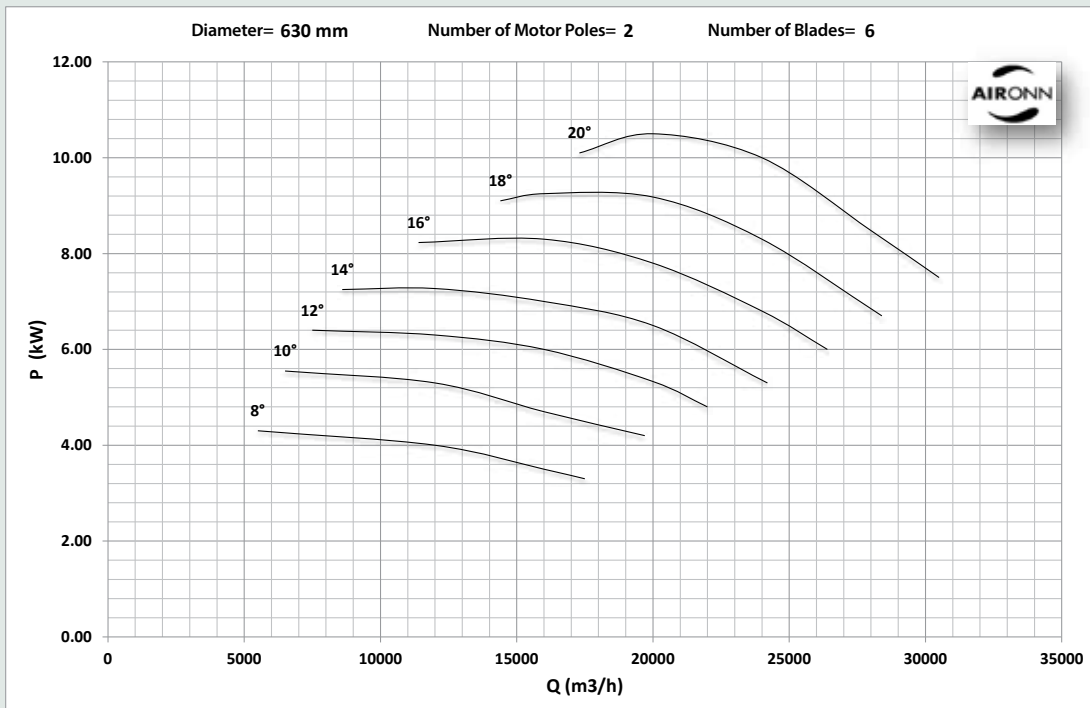
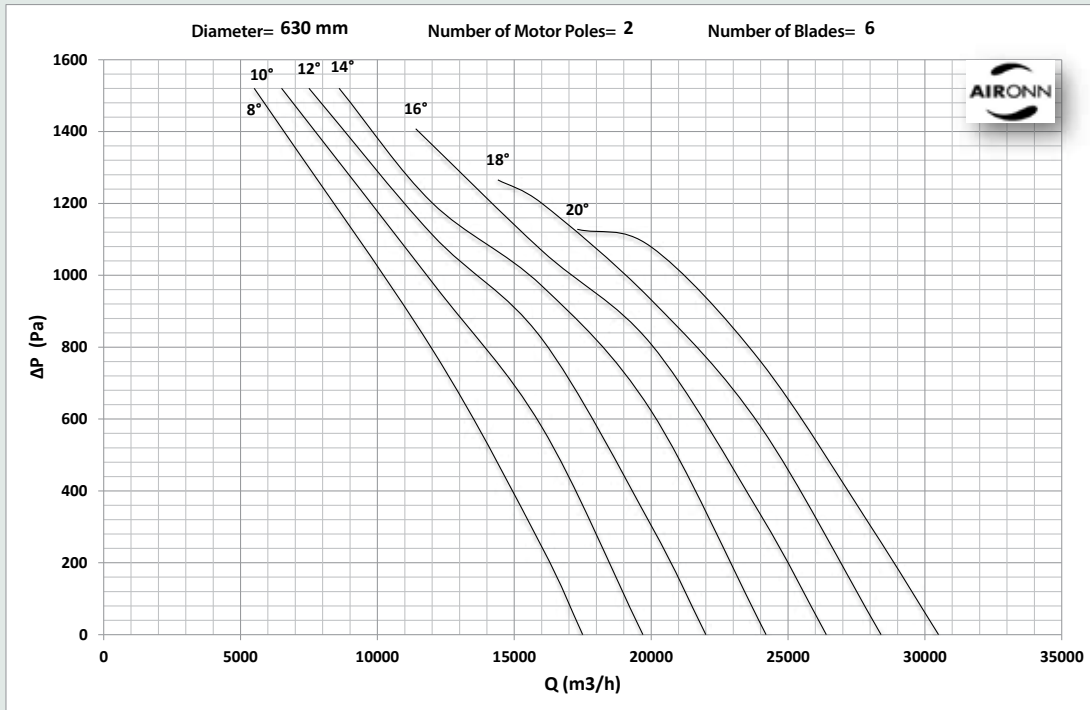

# Cell Type Axial Smoke Exhaust Fan Series

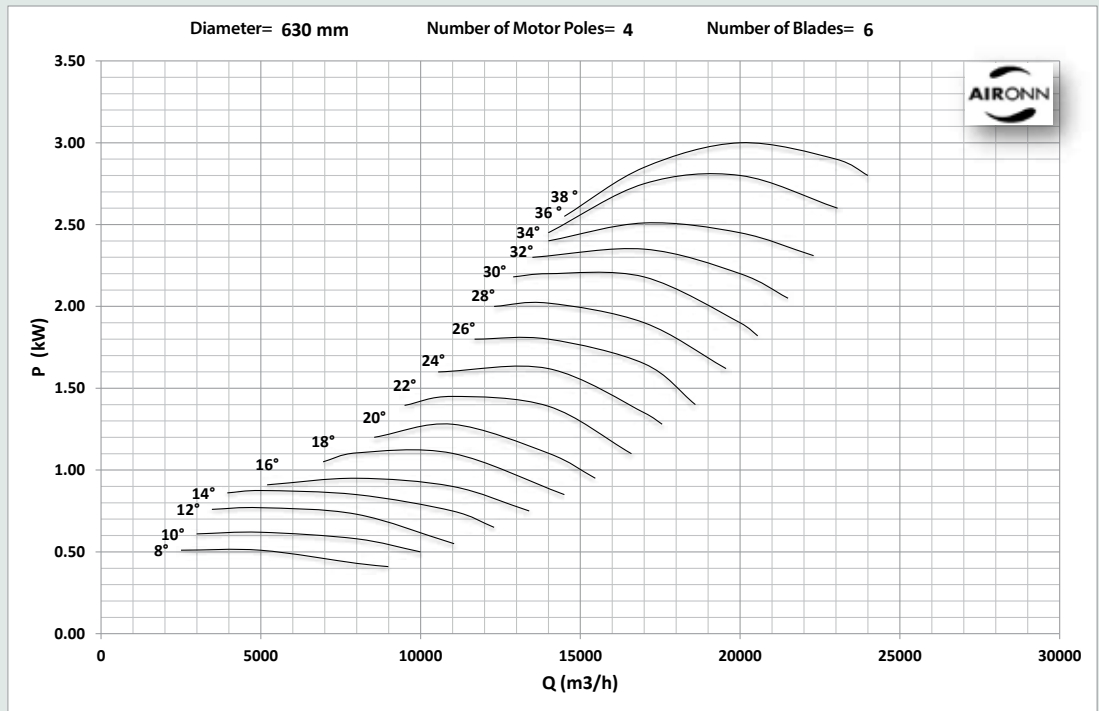
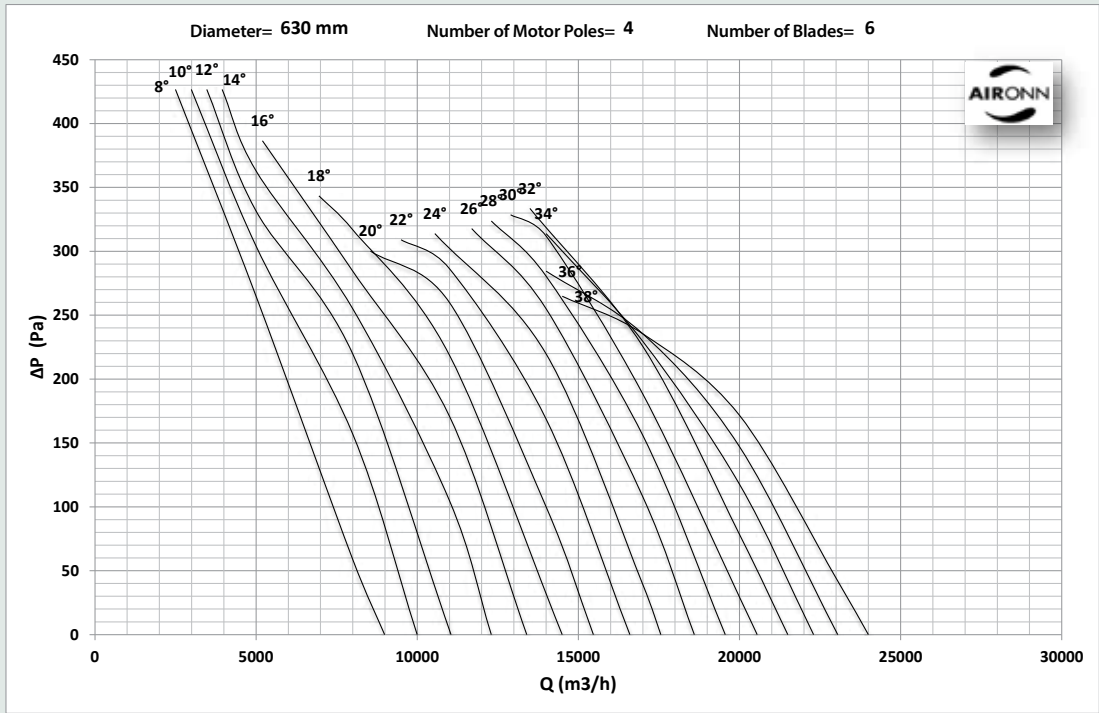

# Cell Type Axial Smoke Exhaust Fan Series

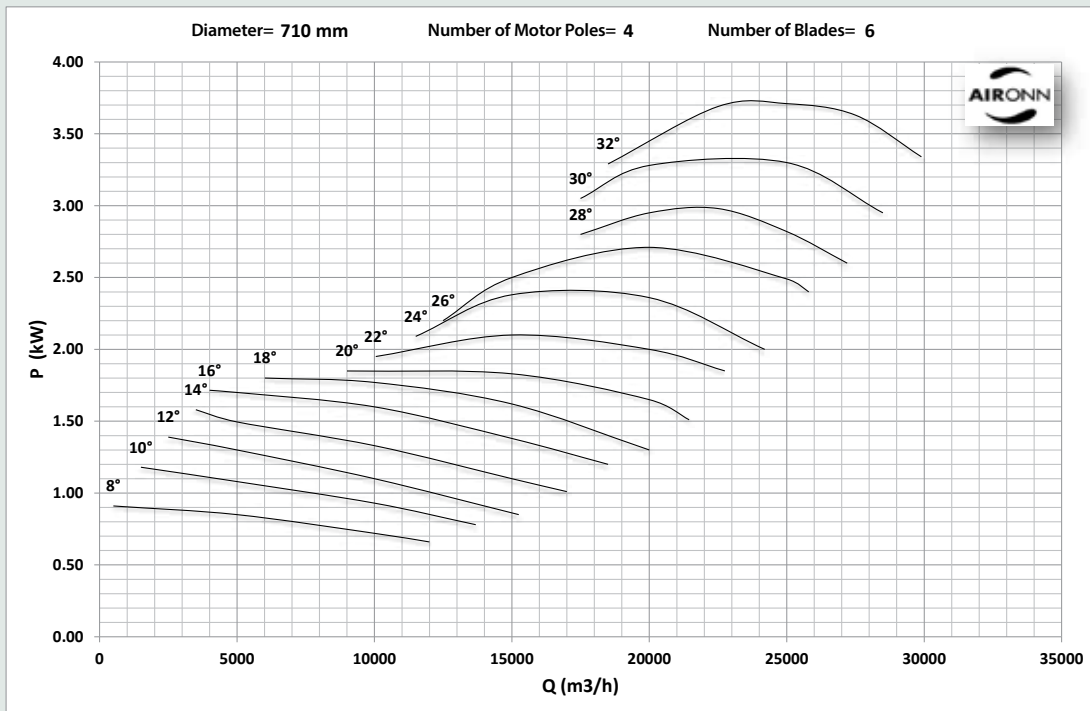
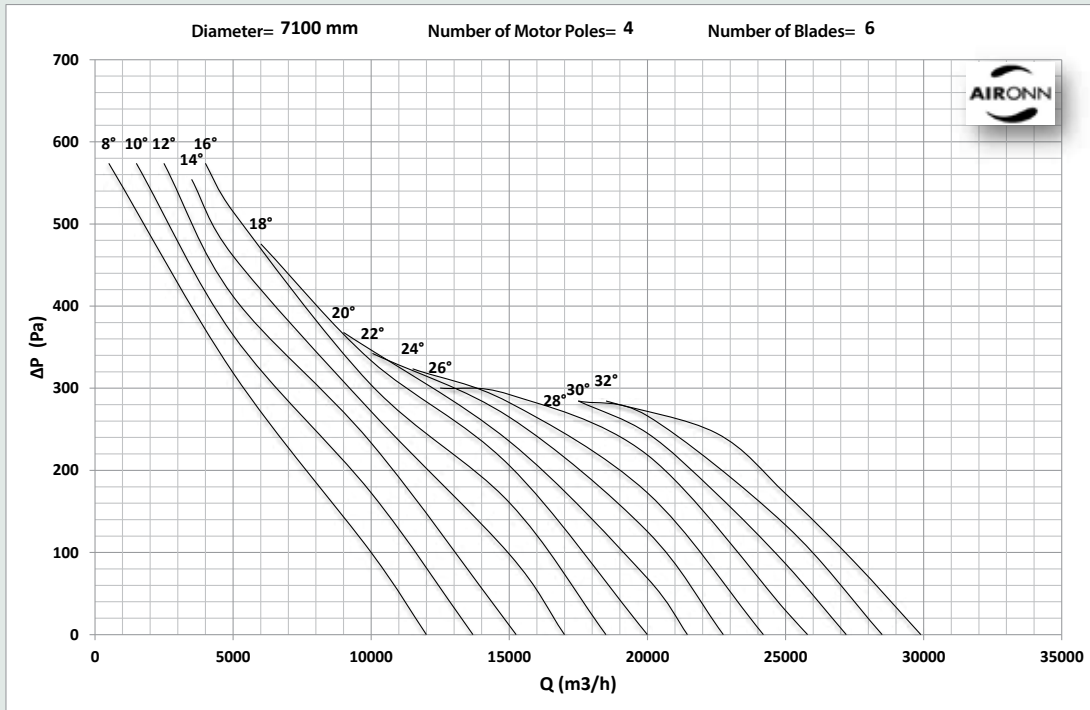

# Cell Type Axial Smoke Exhaust Fan Series

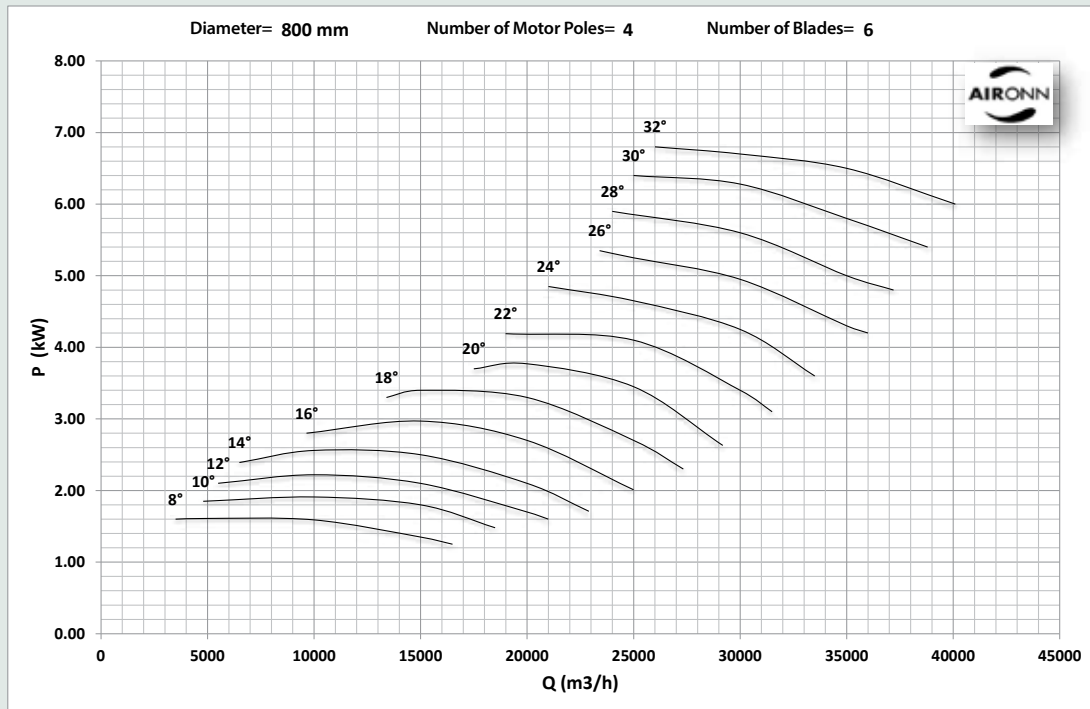
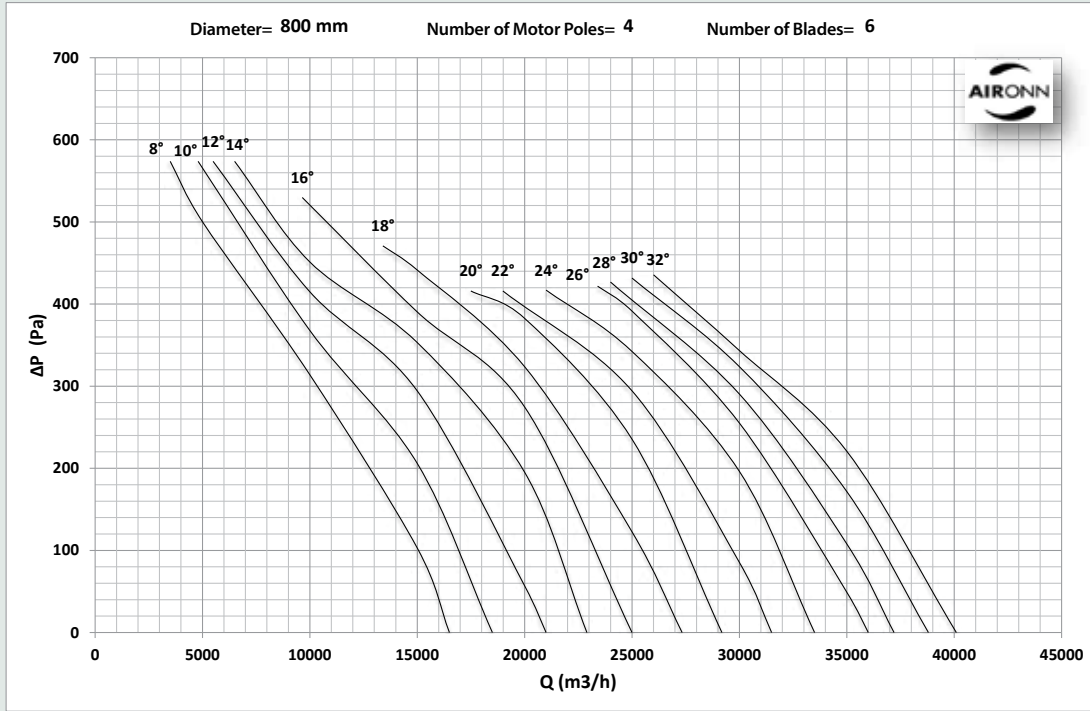



# Cell Type Axial Smoke Exhaust Fan Series

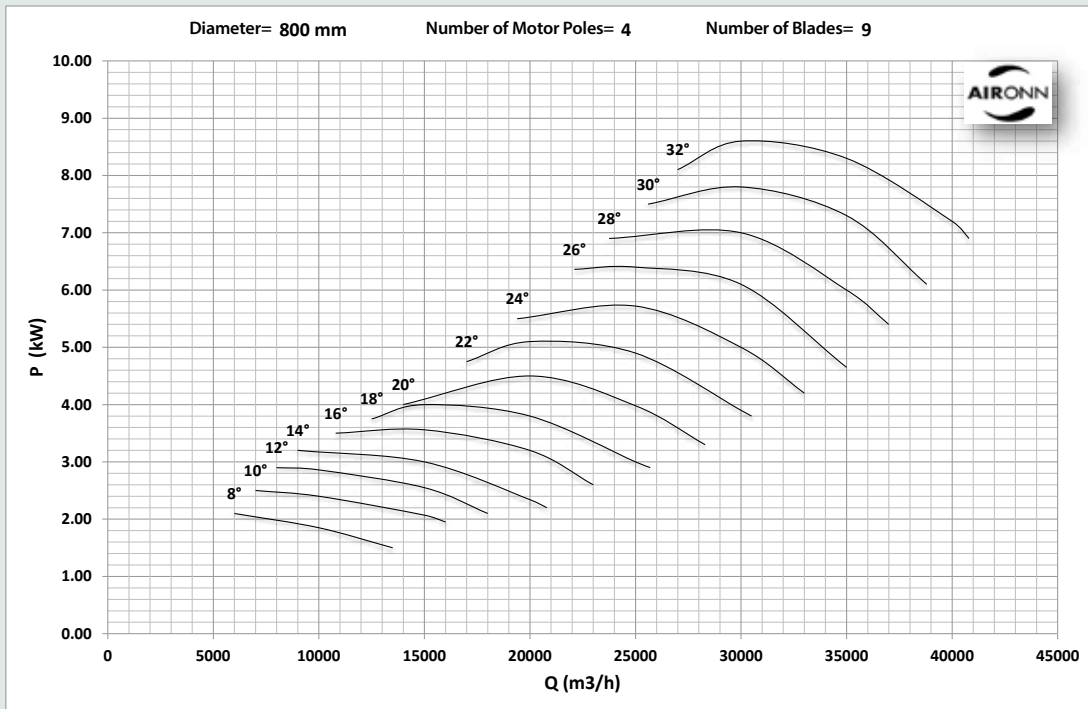
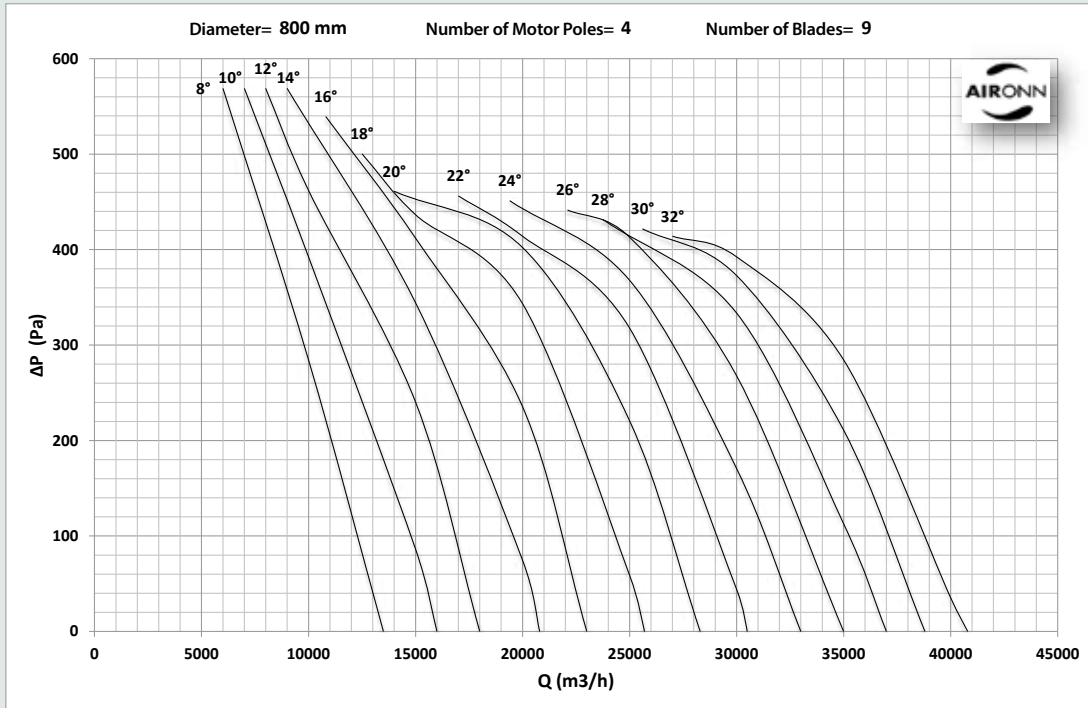

# Cell Type Axial Smoke Exhaust Fan Series

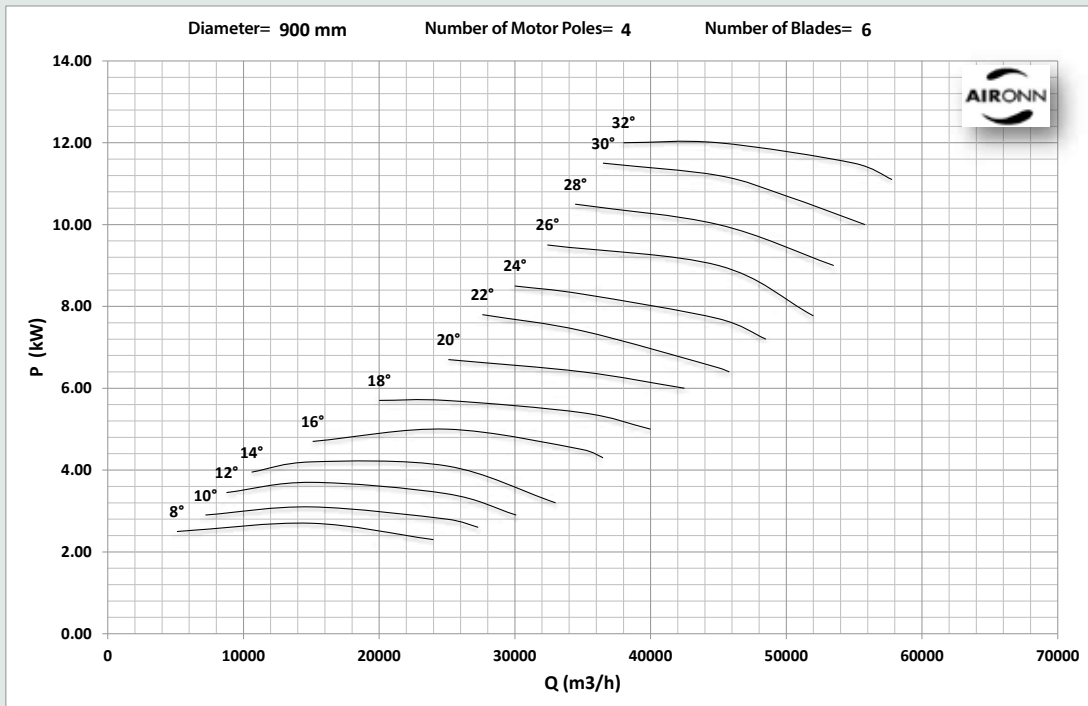
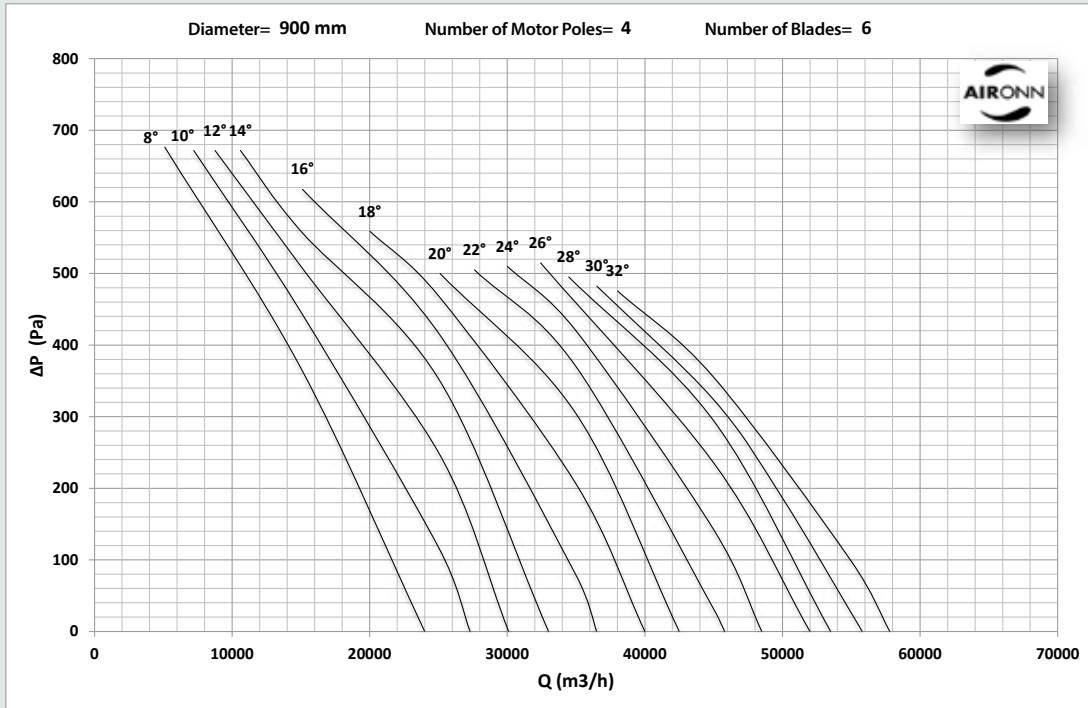

# Cell Type Axial Smoke Exhaust Fan Series

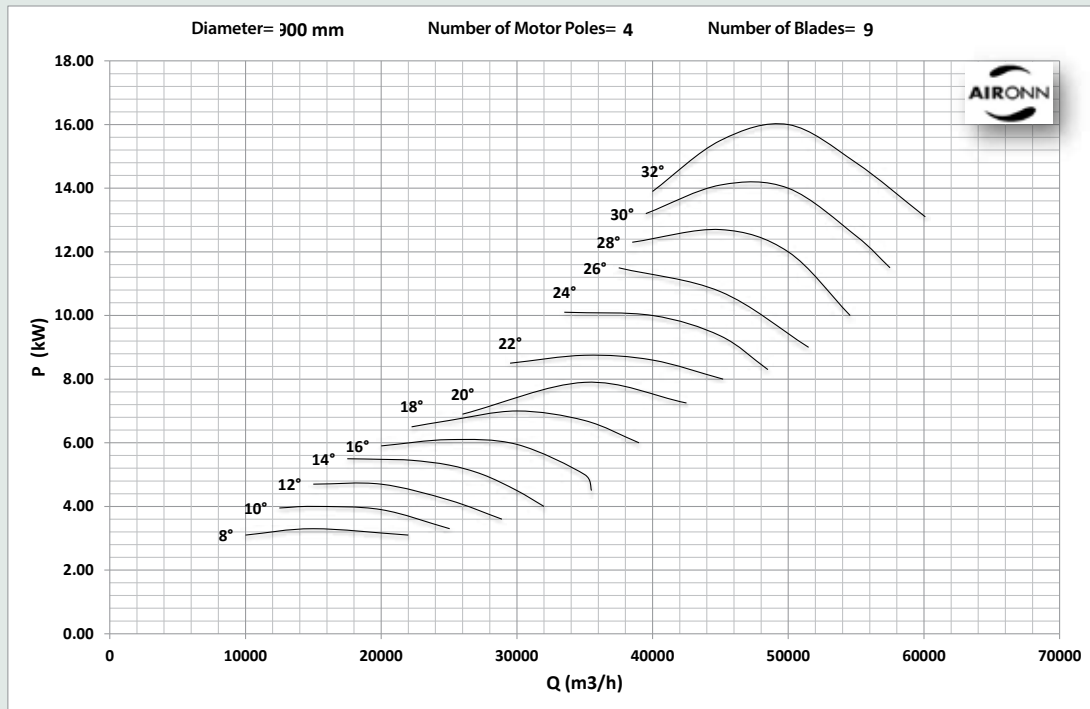
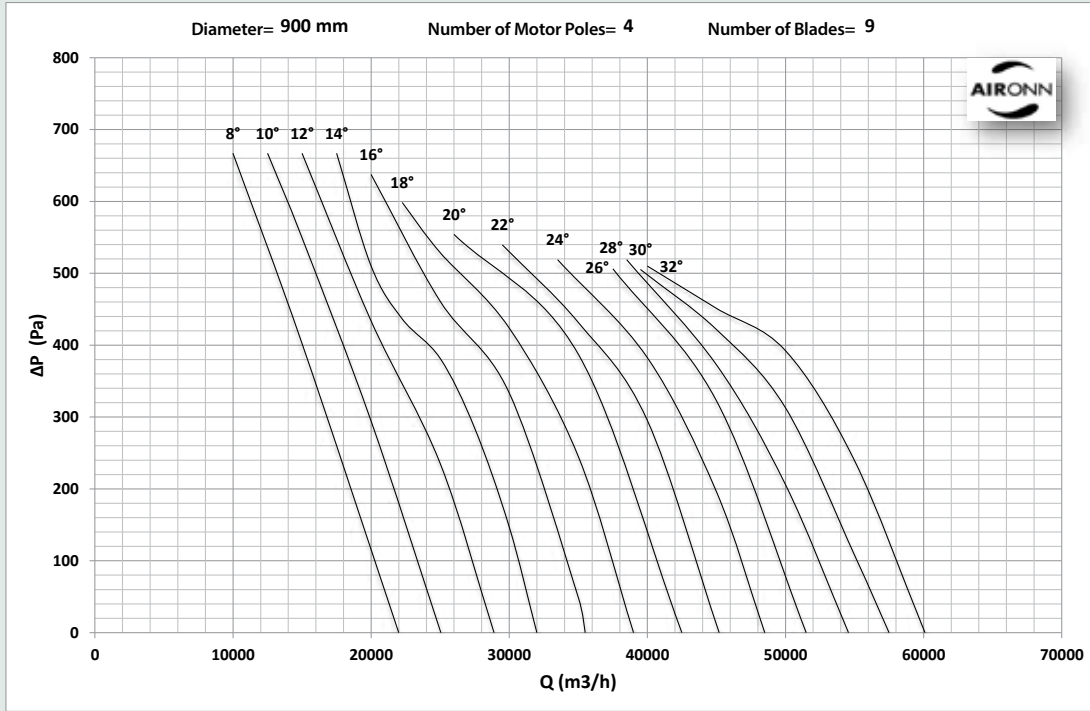

# Cell Type Axial Smoke Exhaust Fan Series

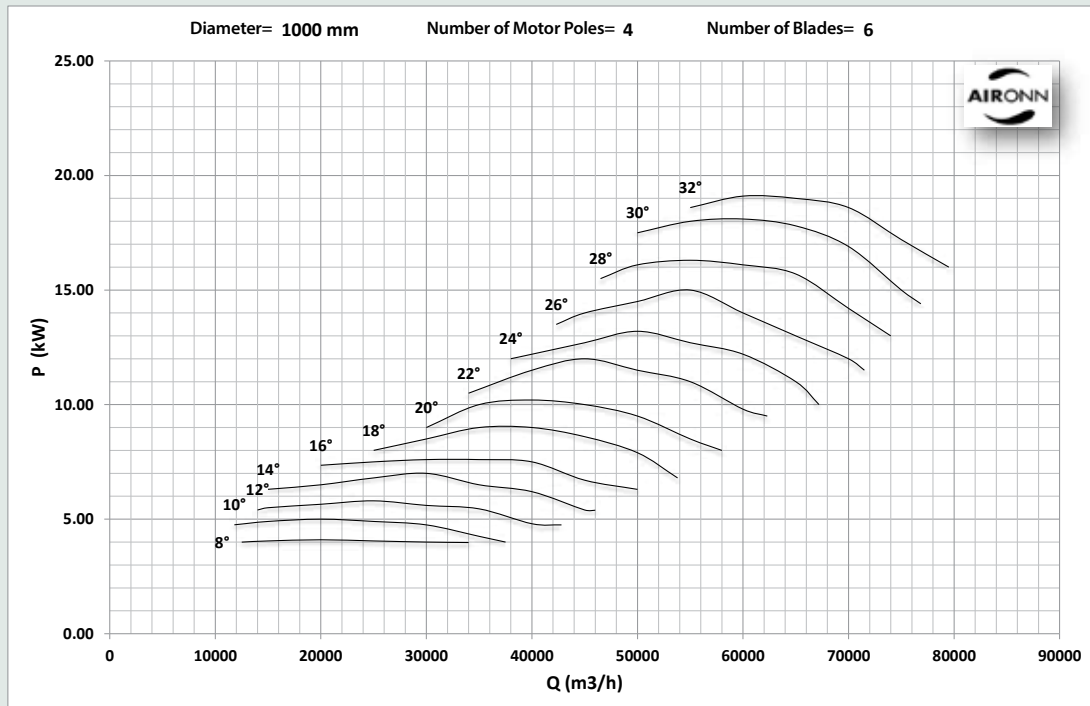
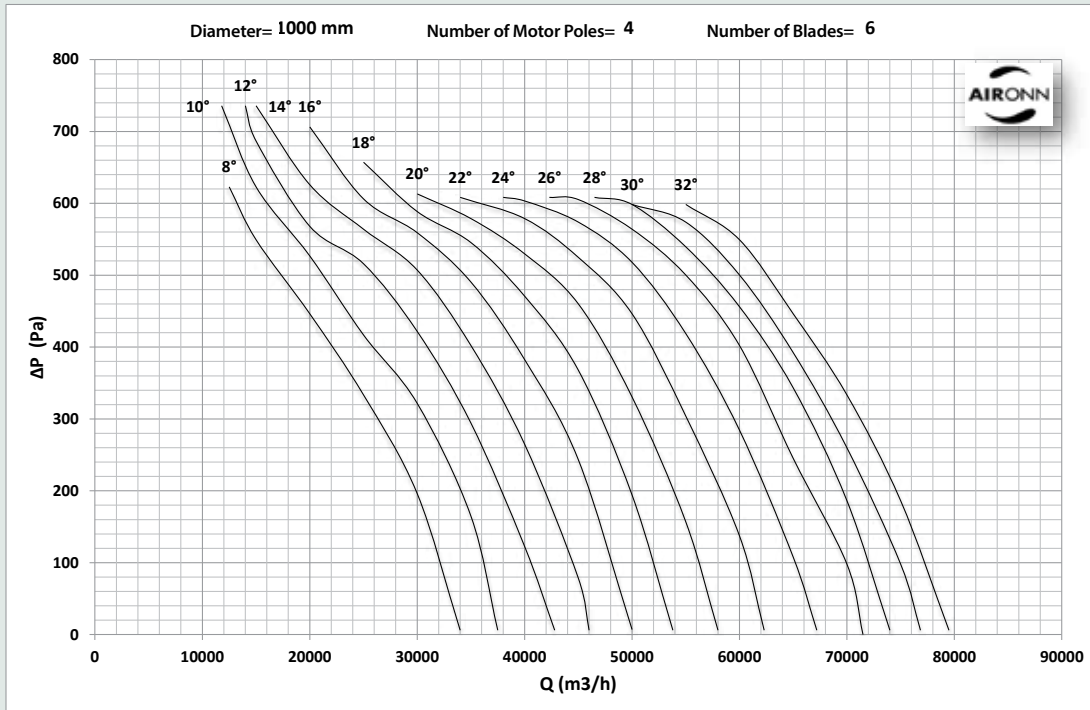

# Cell Type Axial Smoke Exhaust Fan Series

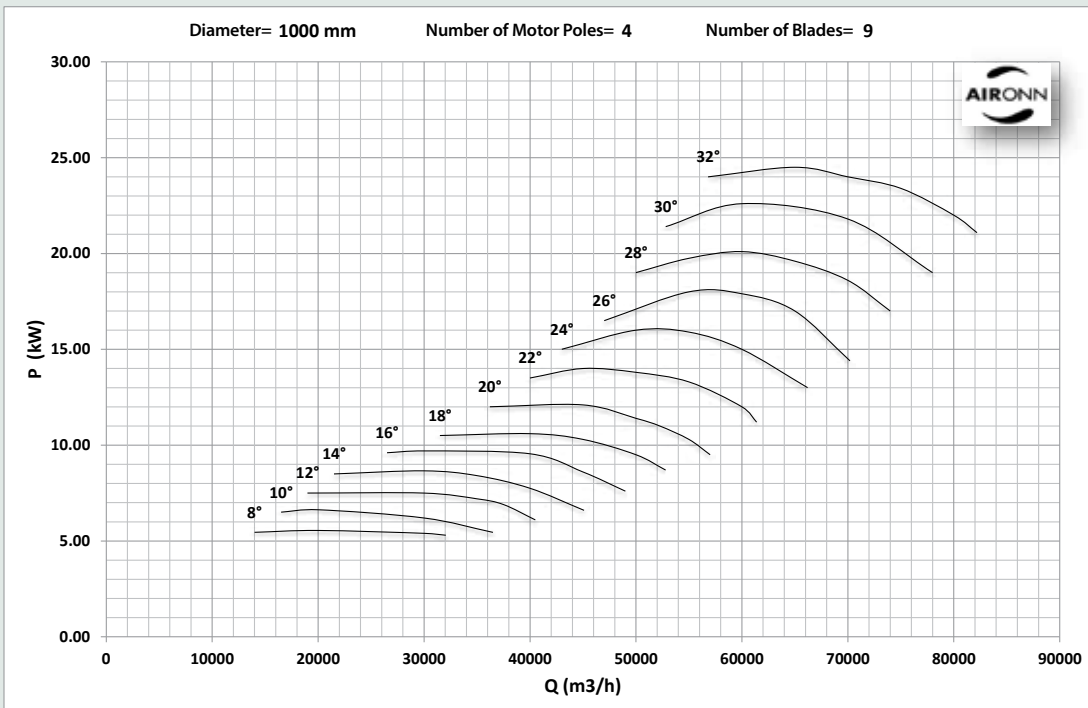
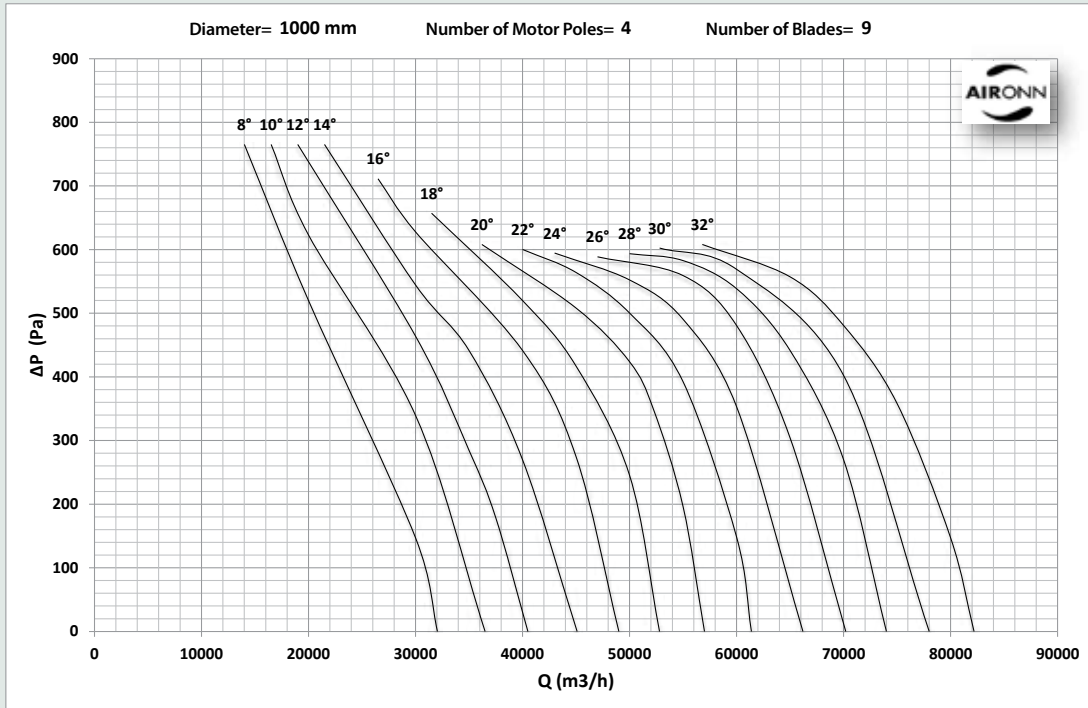

# Cell Type Axial Smoke Exhaust Fan Series

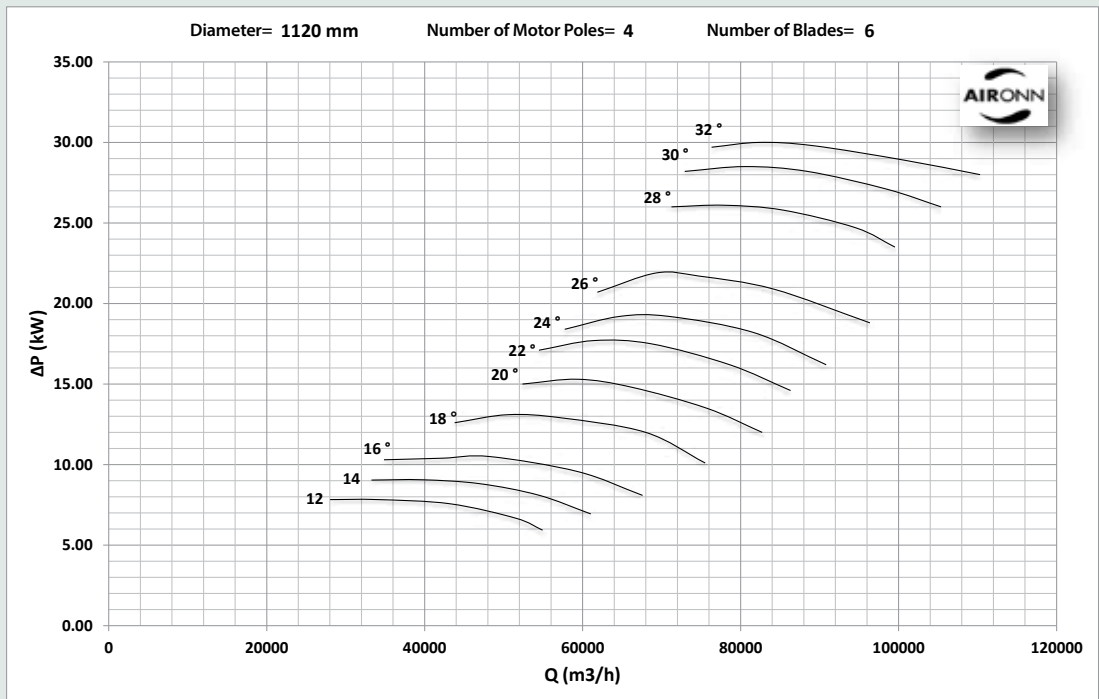
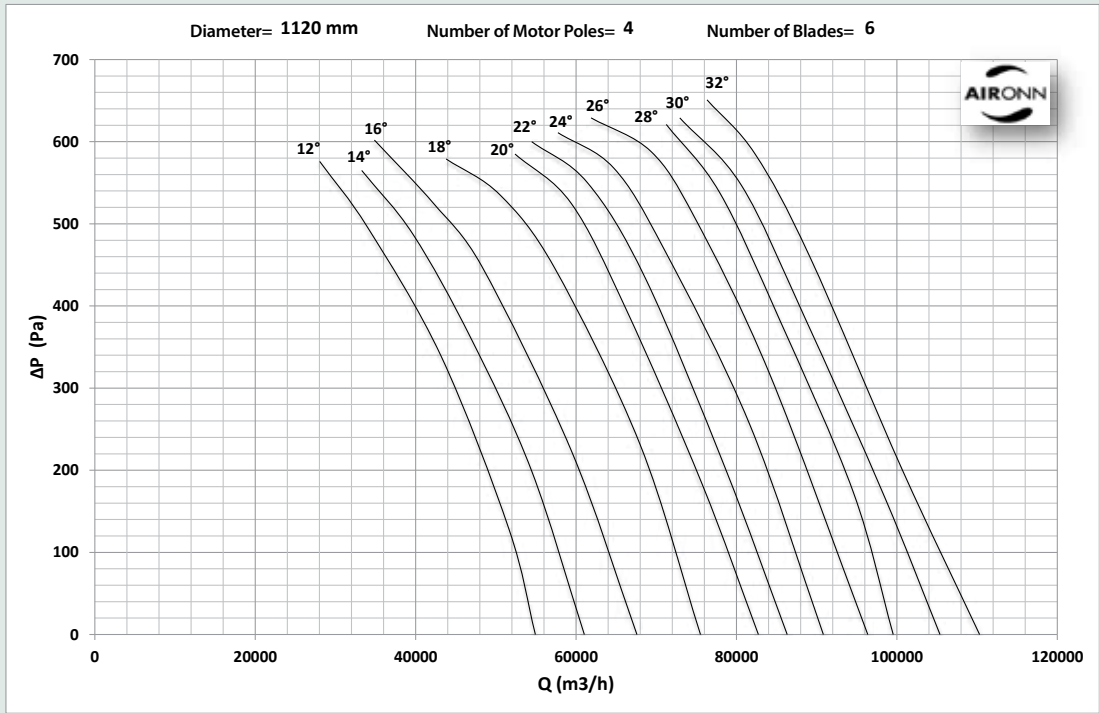

# Cell Type Axial Smoke Exhaust Fan Series

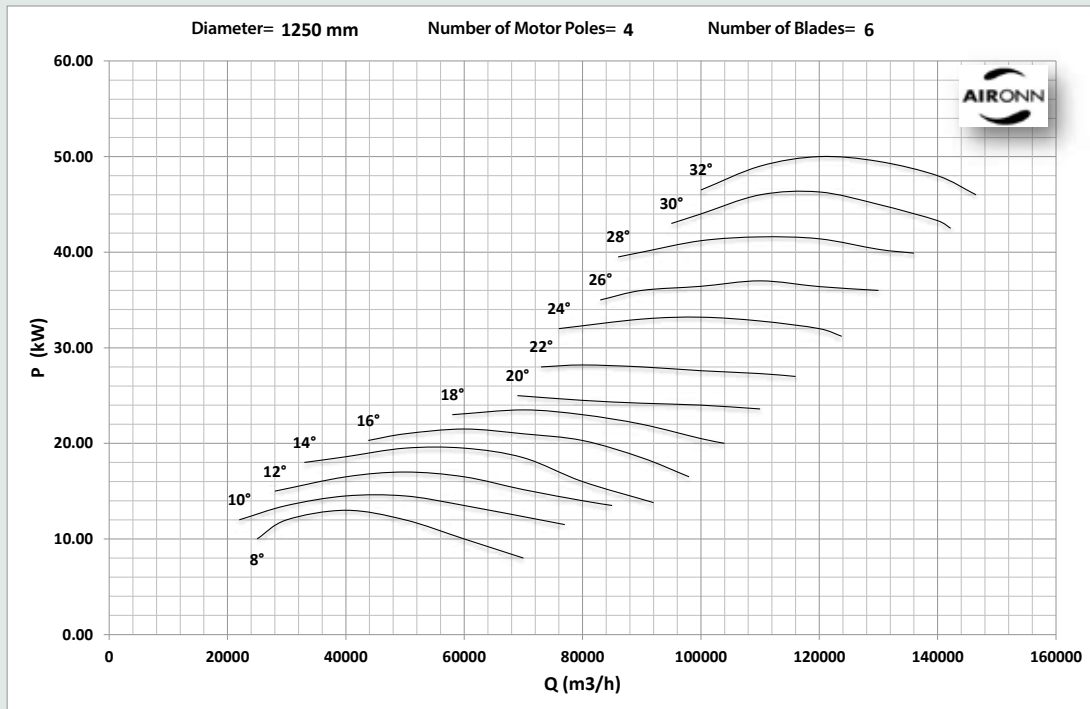
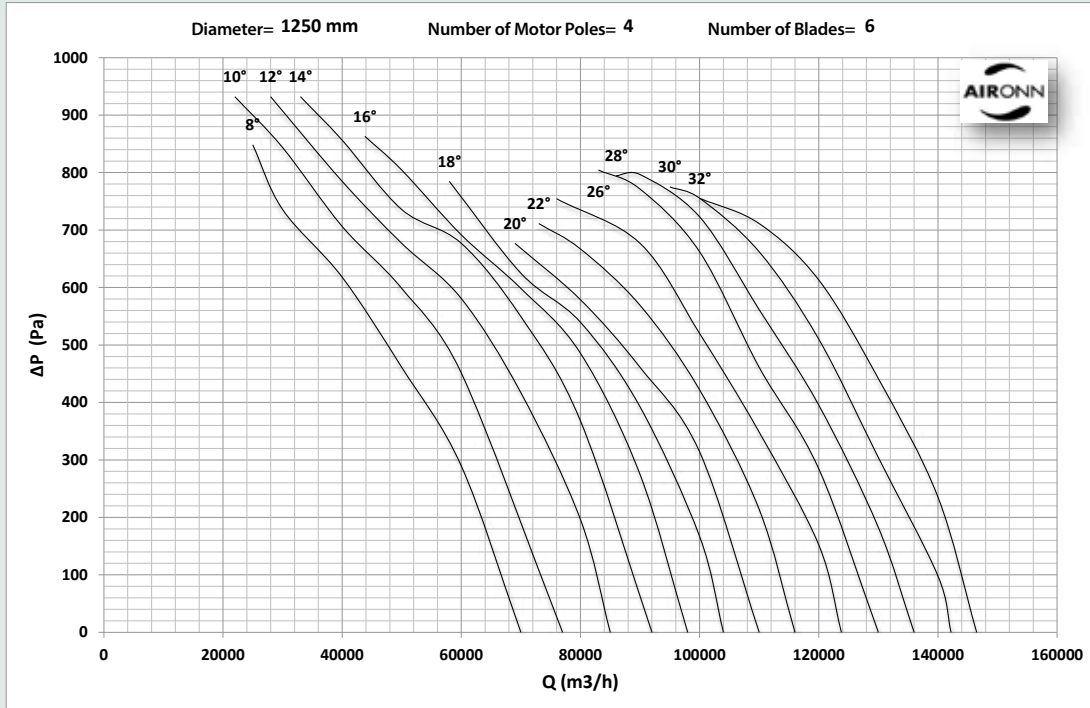

# Cell Type Axial Smoke Exhaust Fan Series

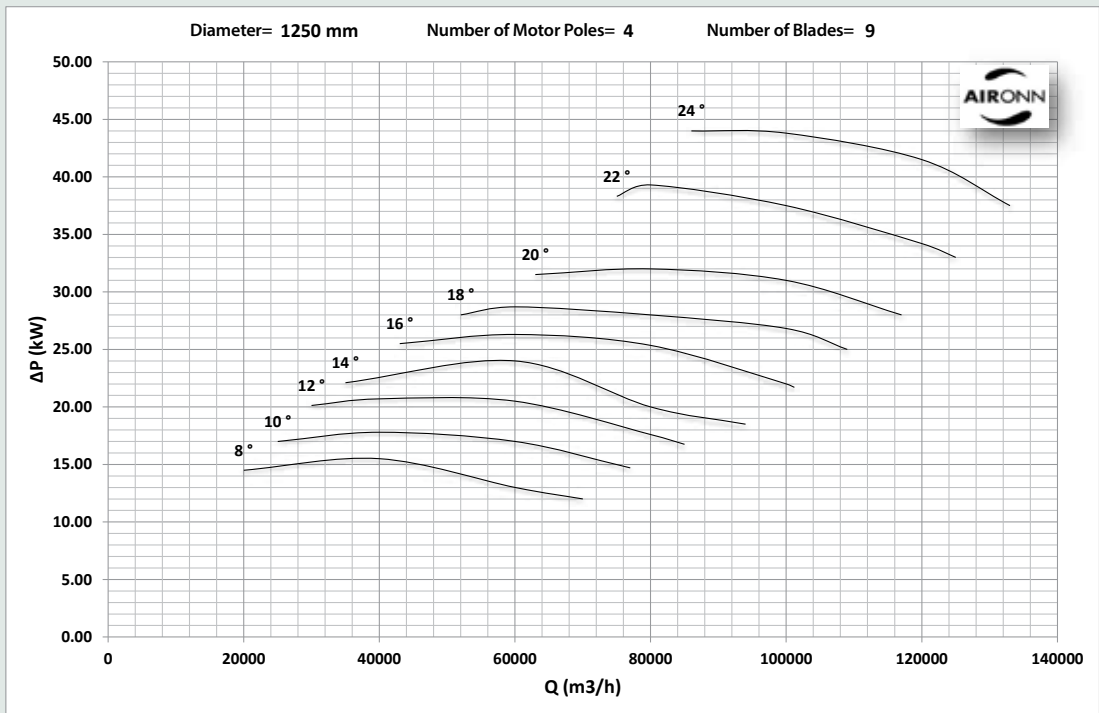
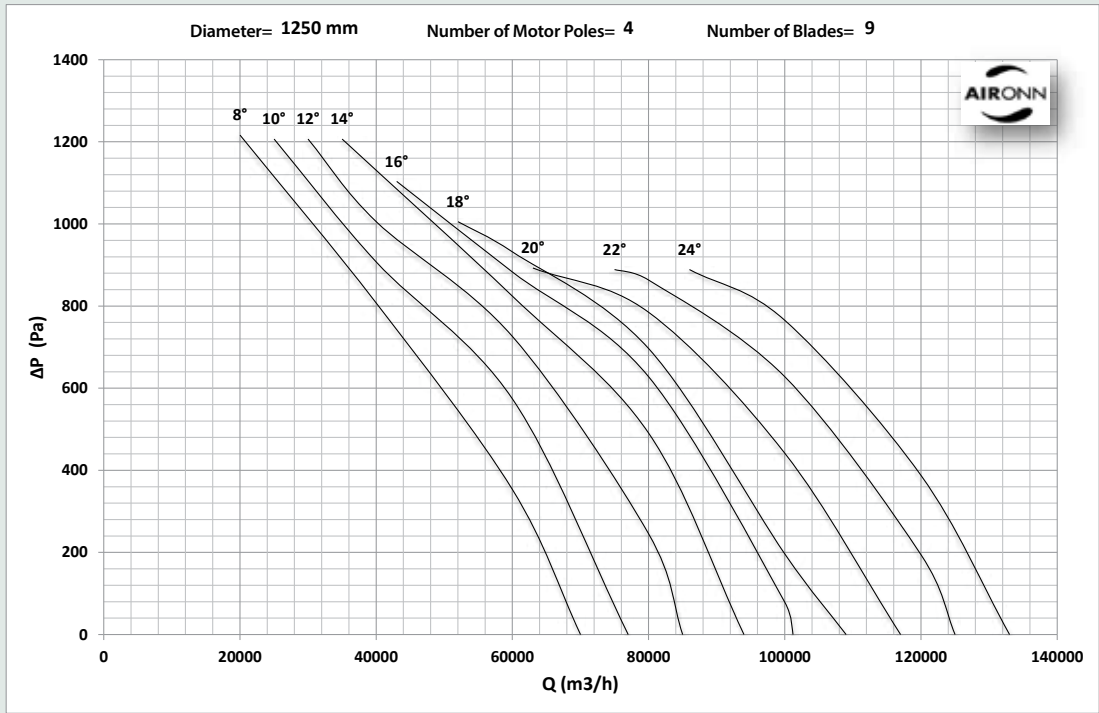



# Cell Type Axial Smoke Exhaust Fan Series

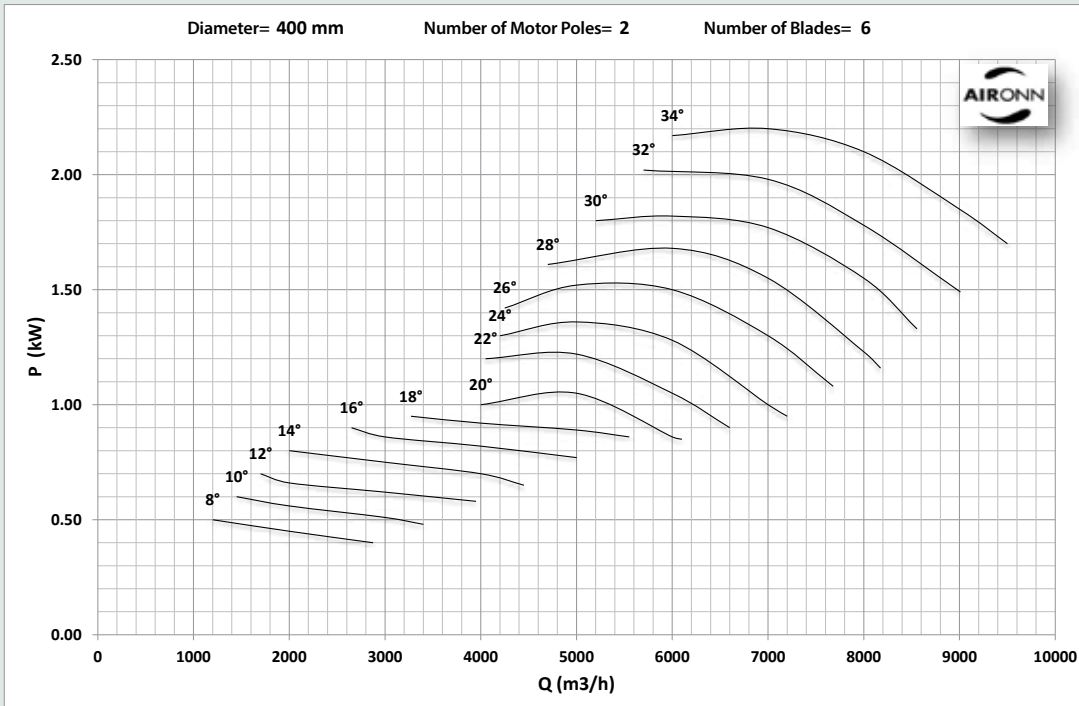
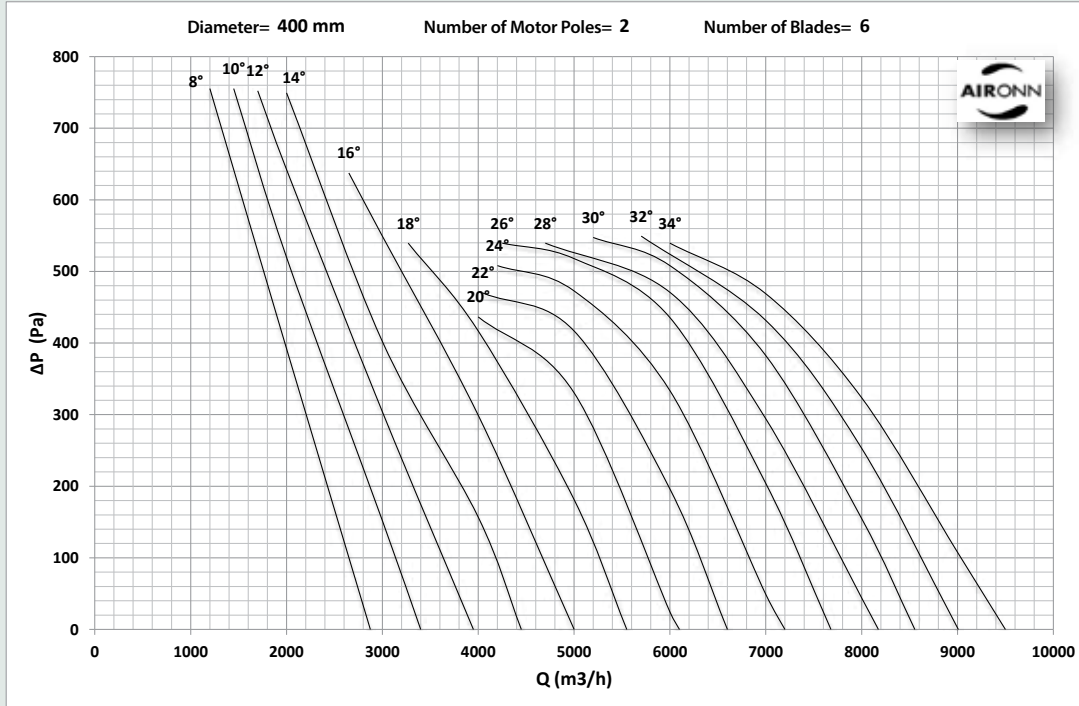

# Cell Type Axial Smoke Exhaust Fan Series

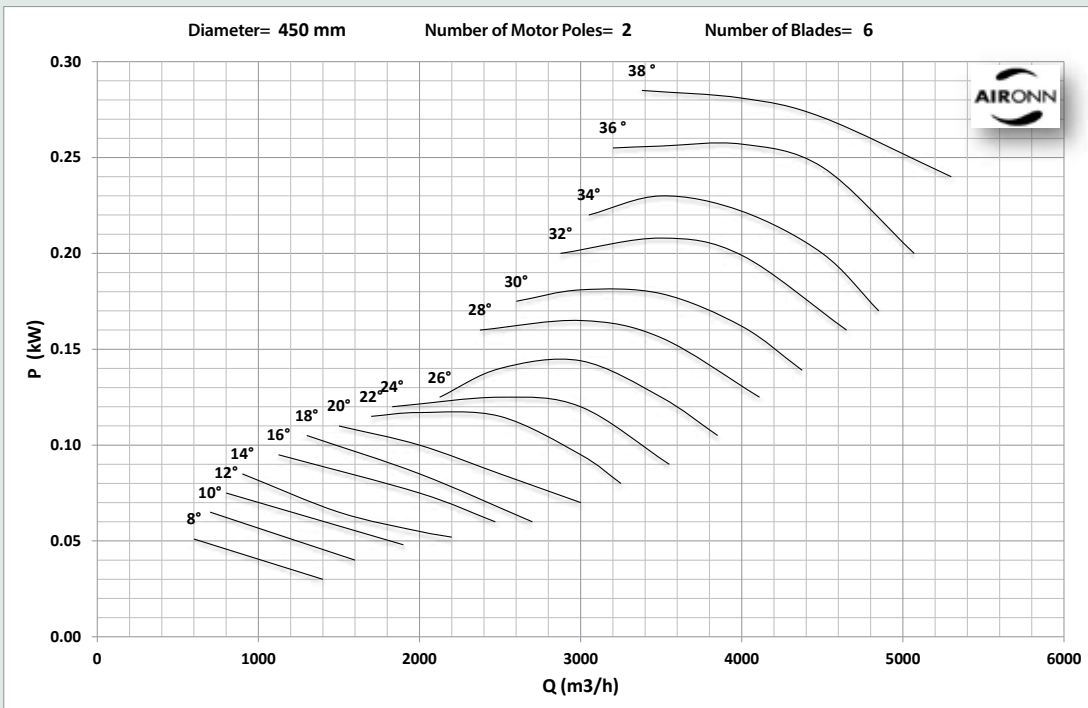
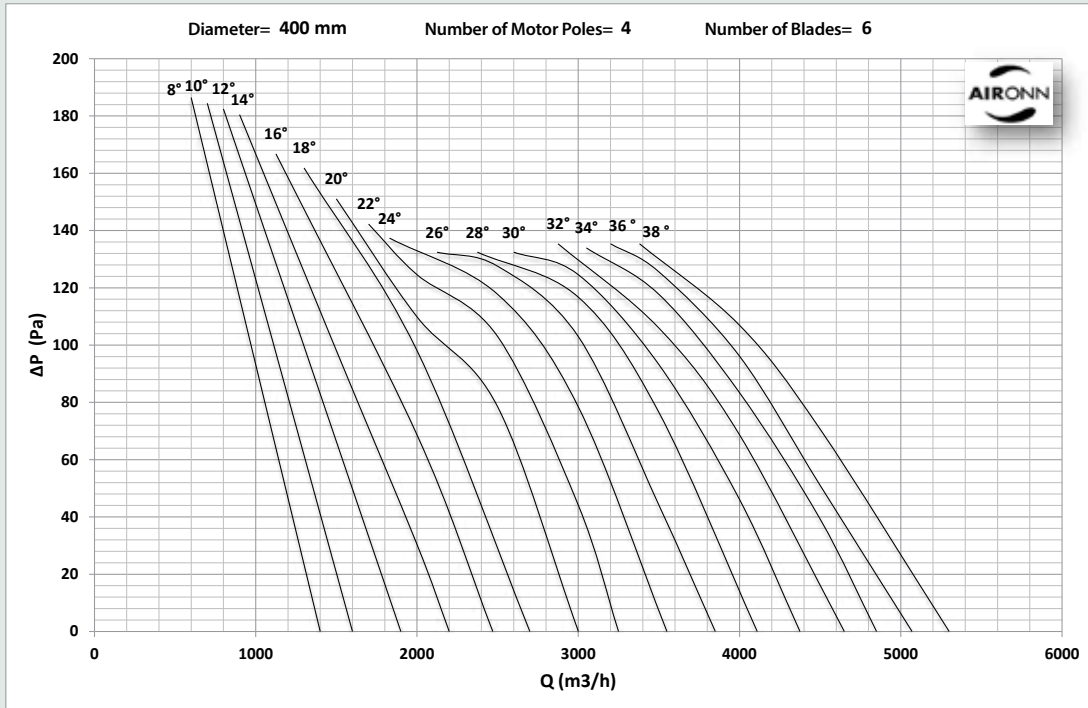

# Cell Type Axial Smoke Exhaust Fan Series

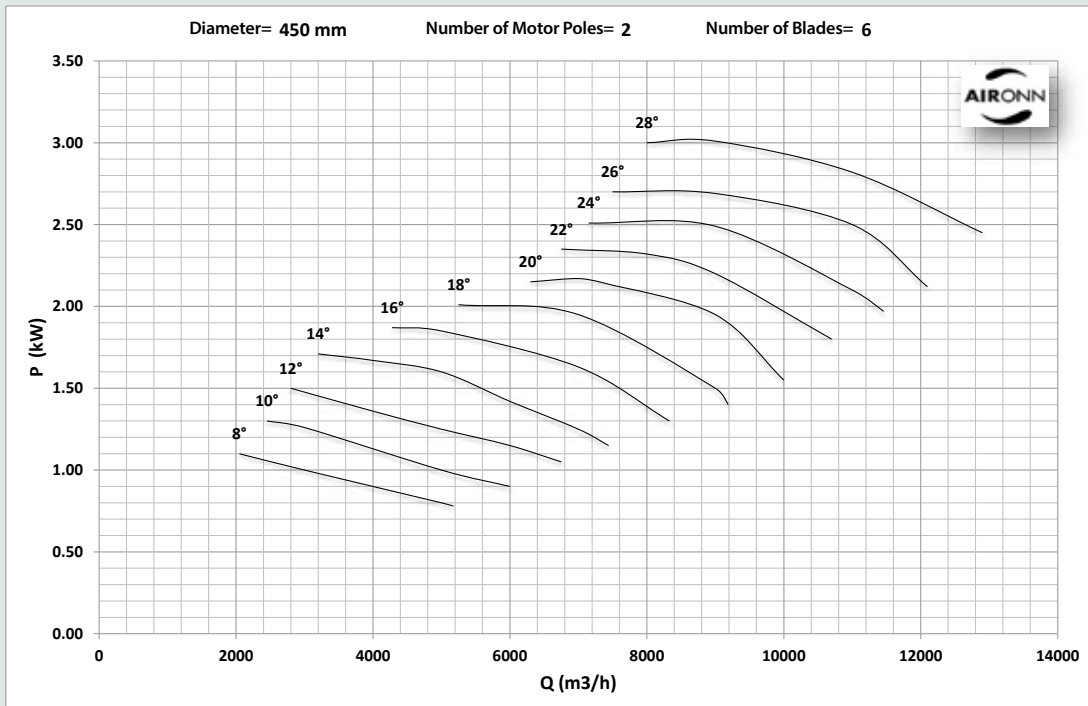
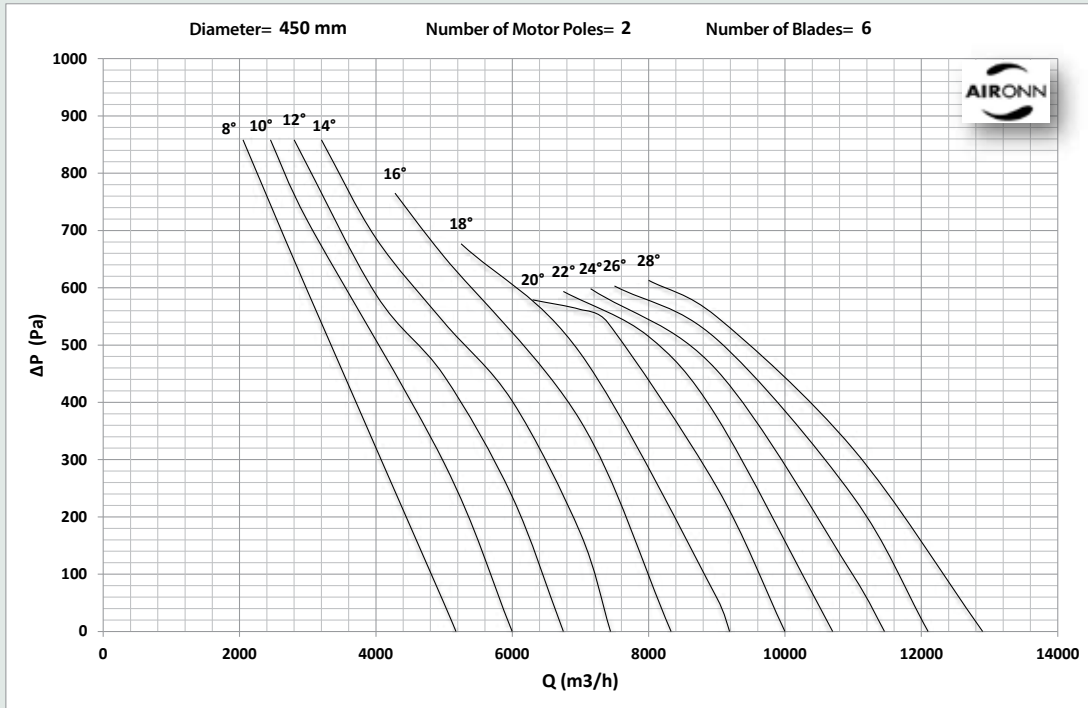

# Cell Type Axial Smoke Exhaust Fan Series

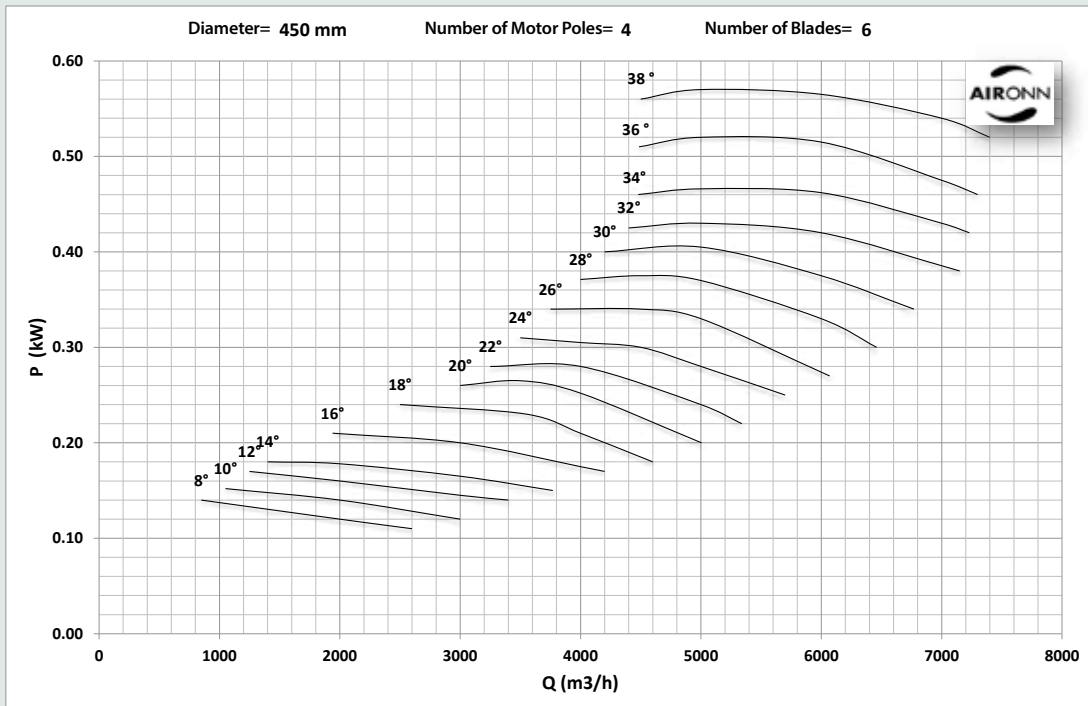
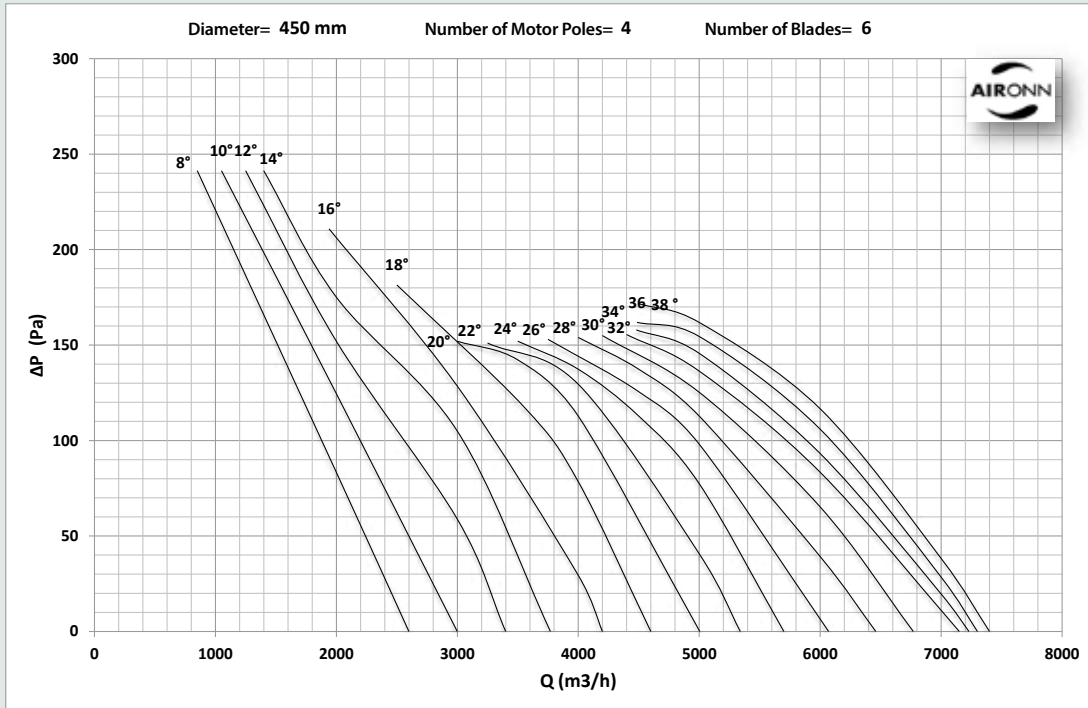

# Cell Type Axial Smoke Exhaust Fan Series

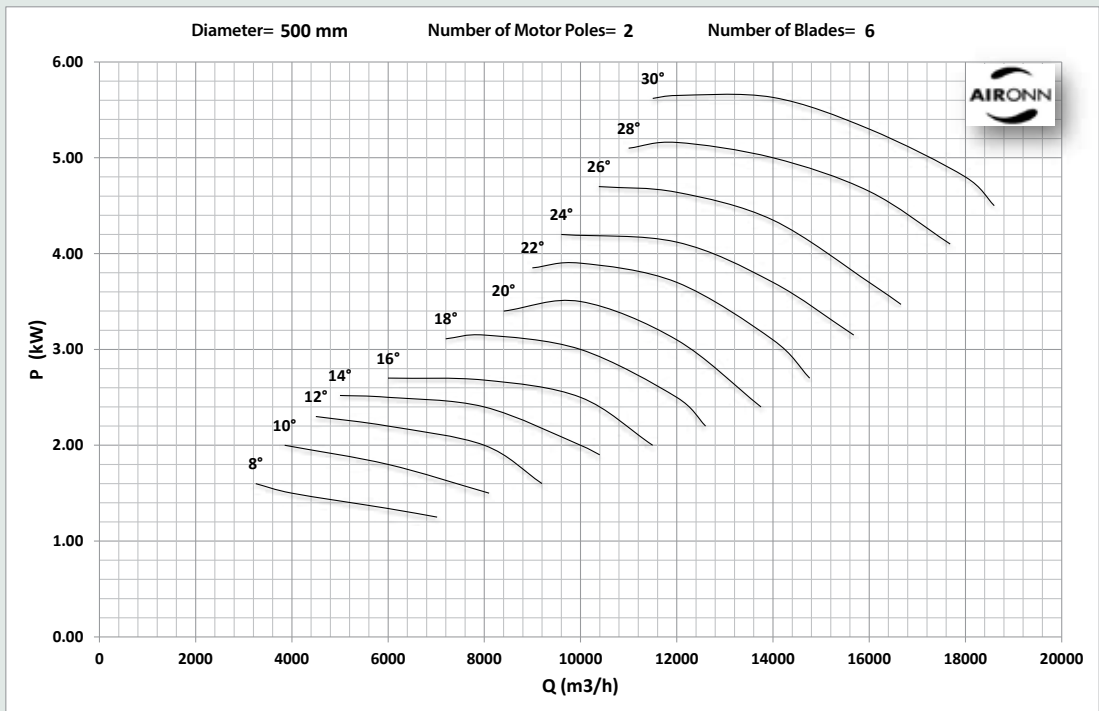
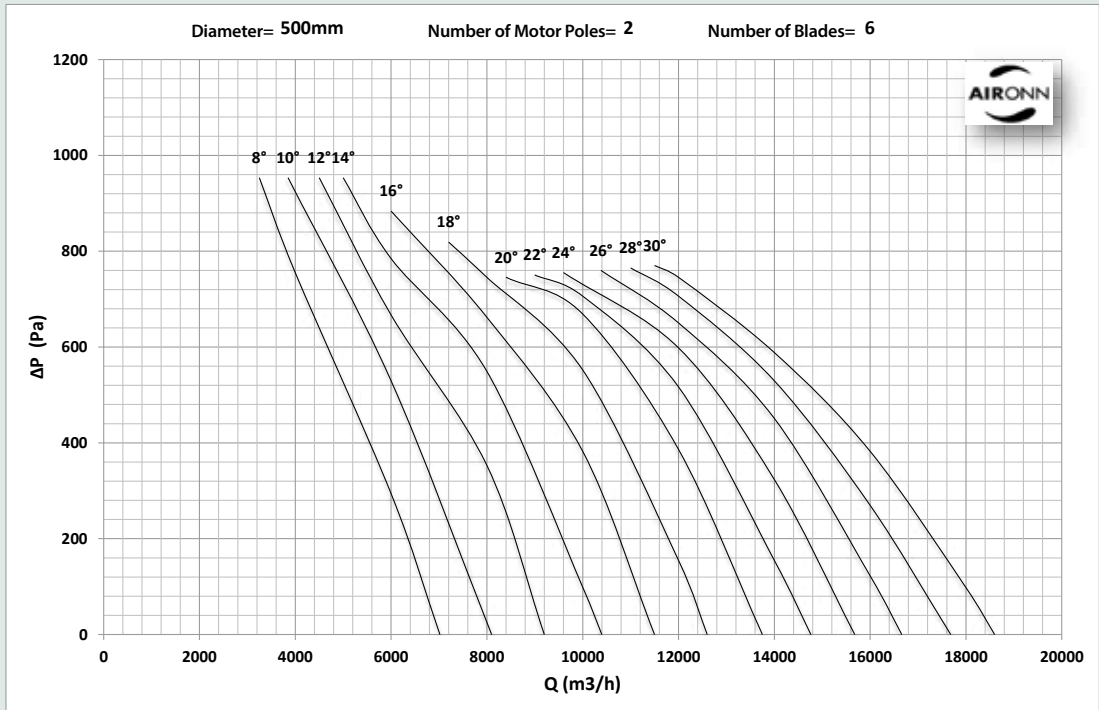

# Cell Type Axial Smoke Exhaust Fan Series

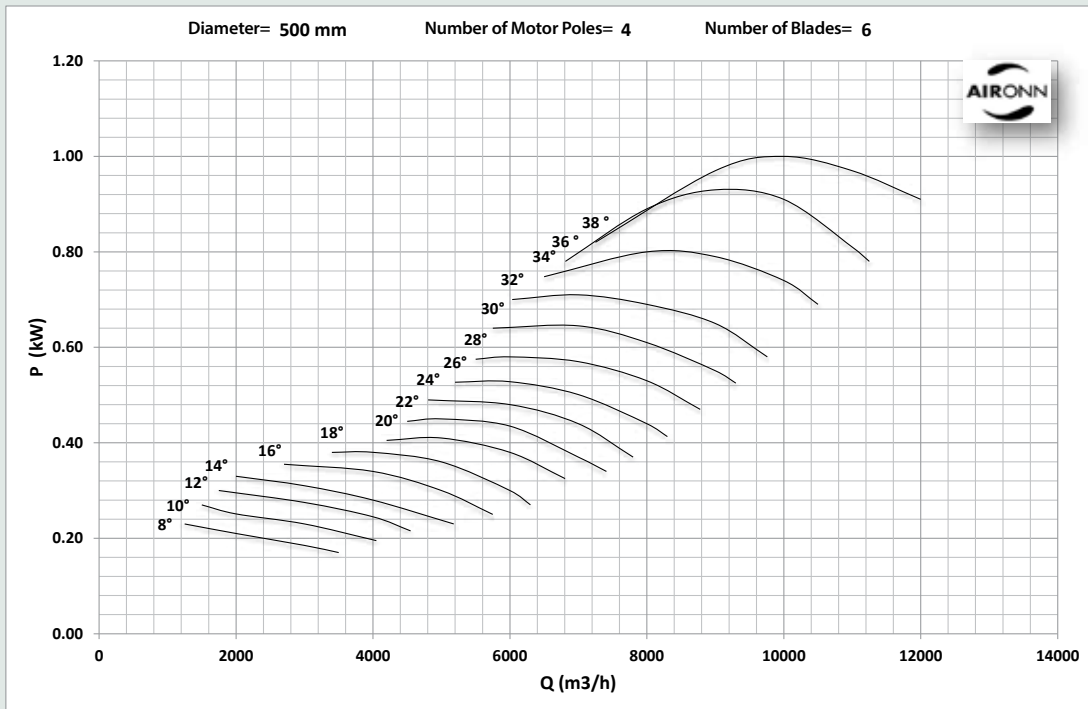
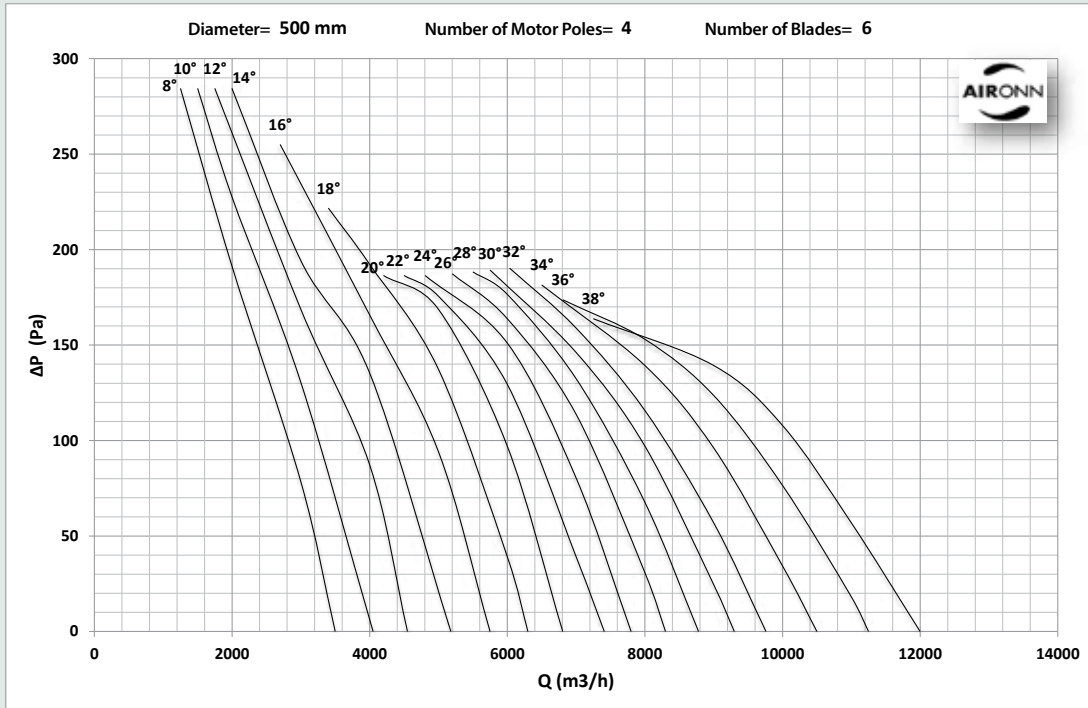

# Cell Type Axial Smoke Exhaust Fan Series

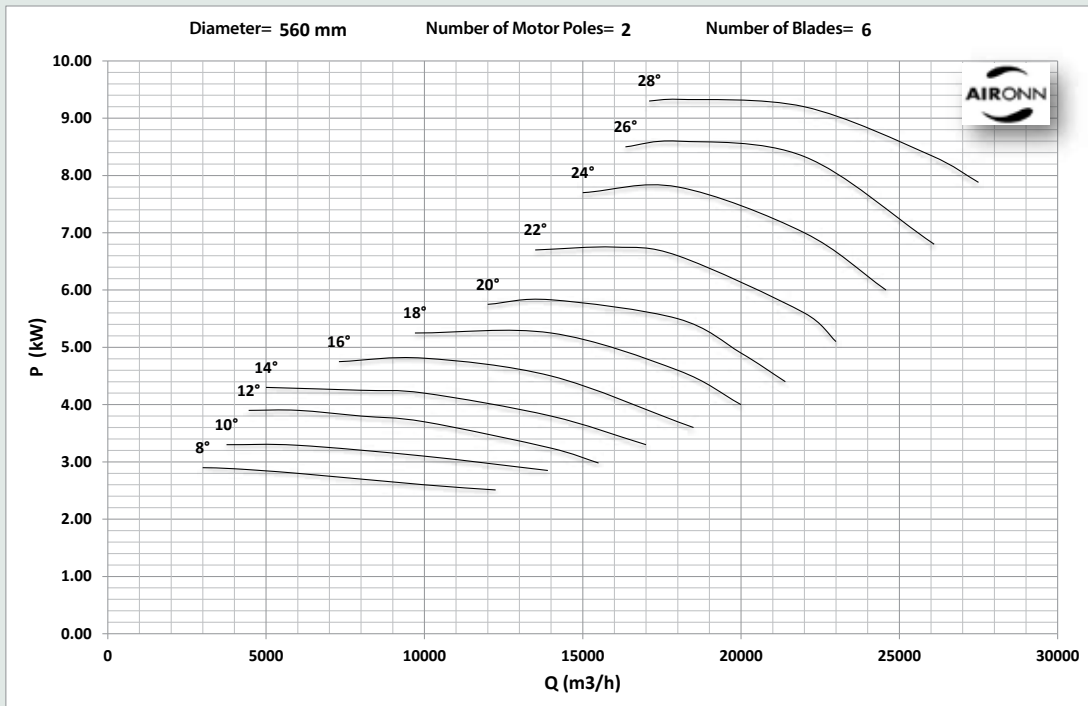
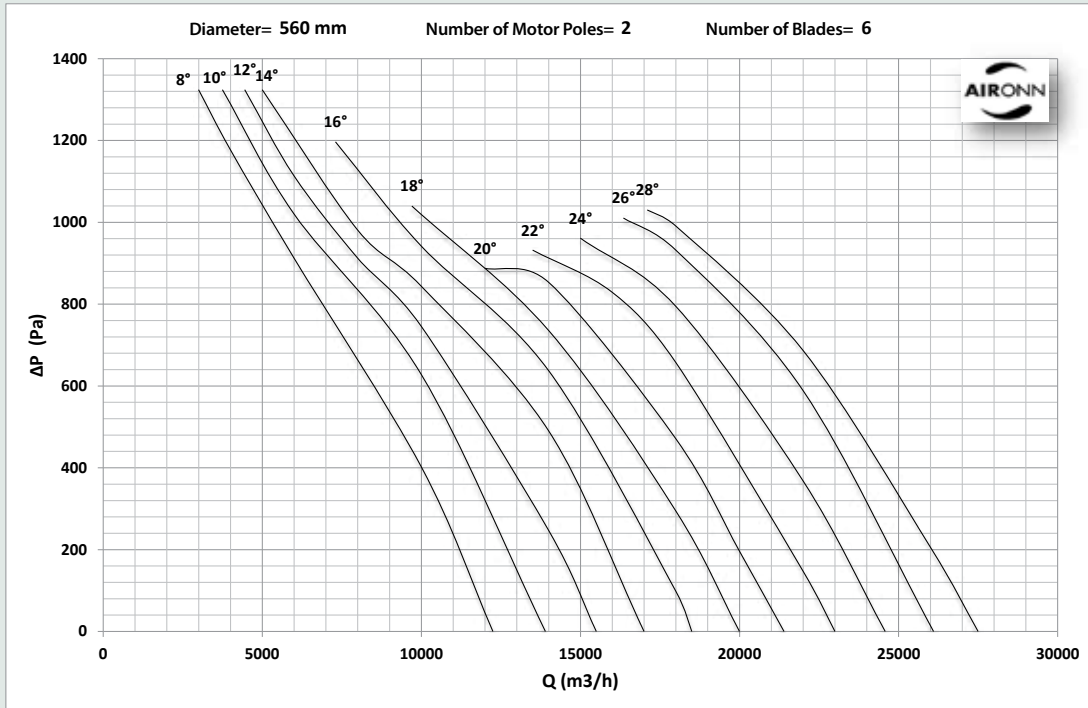

# Cell Type Axial Smoke Exhaust Fan Series

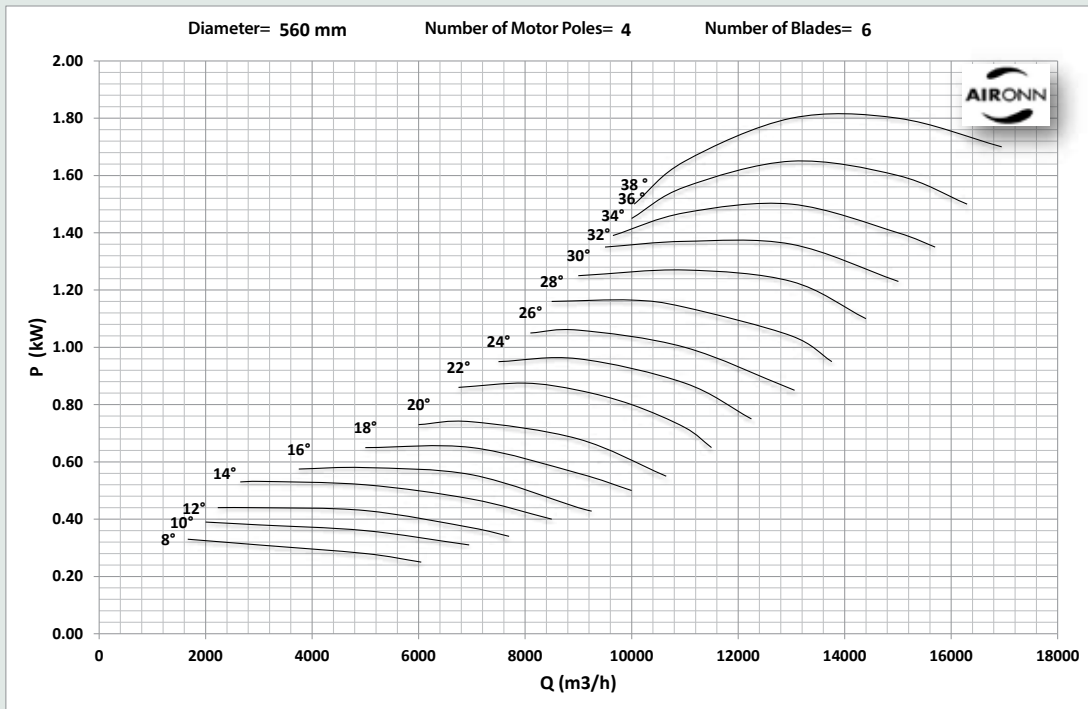
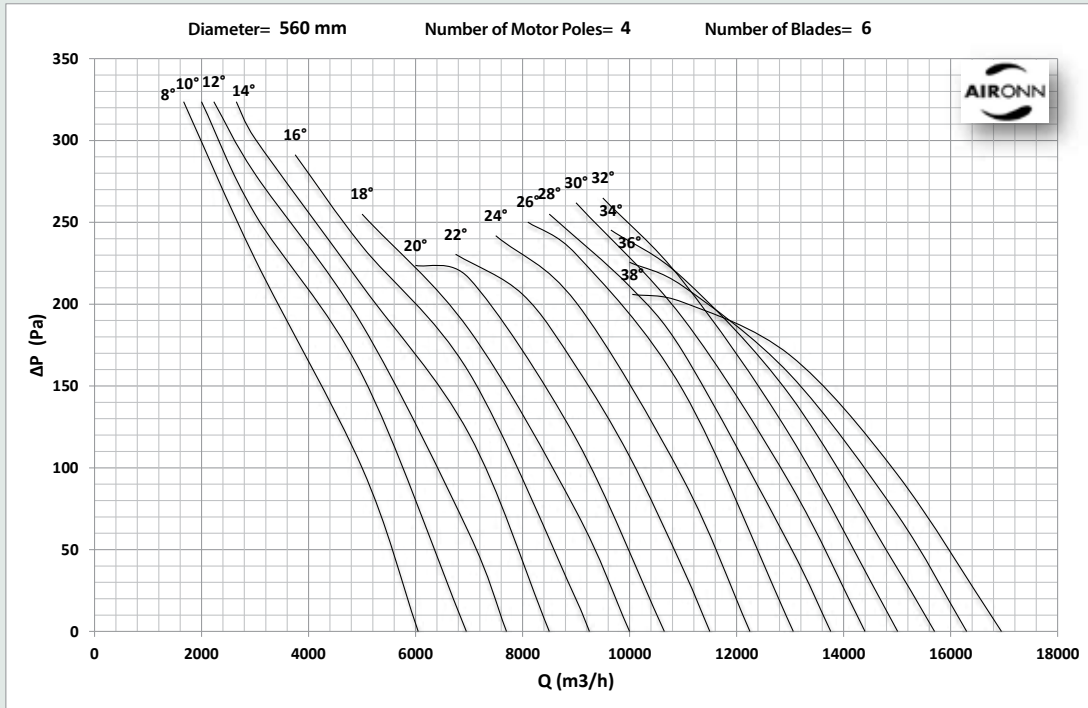



# Cell Type Axial Smoke Exhaust Fan Series

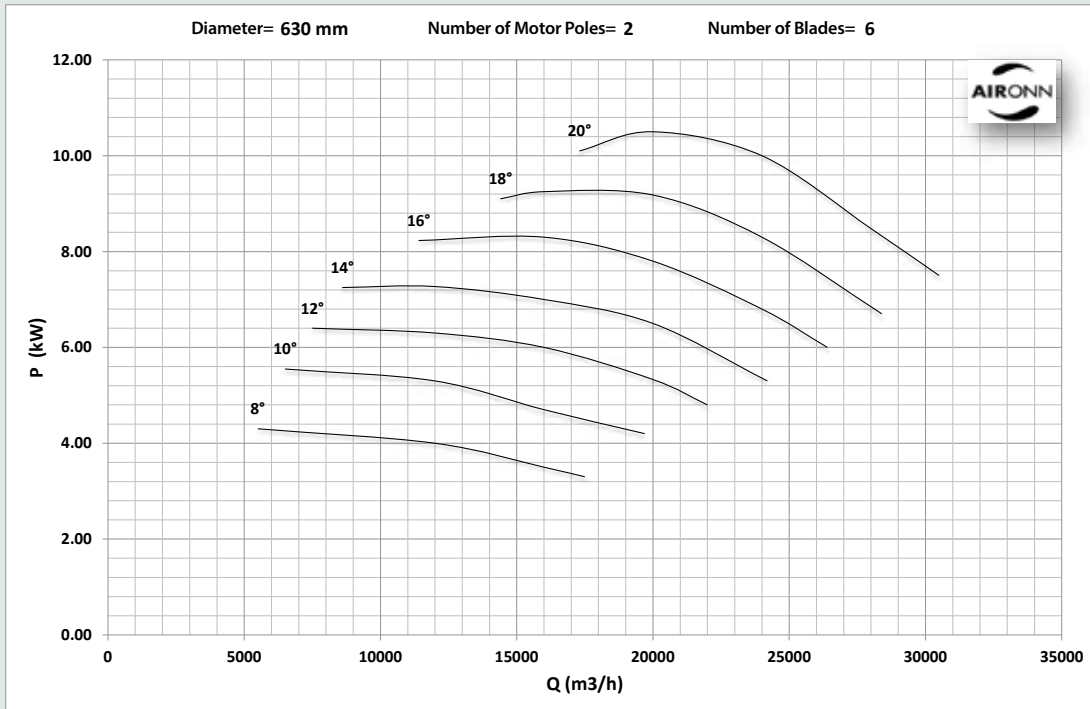
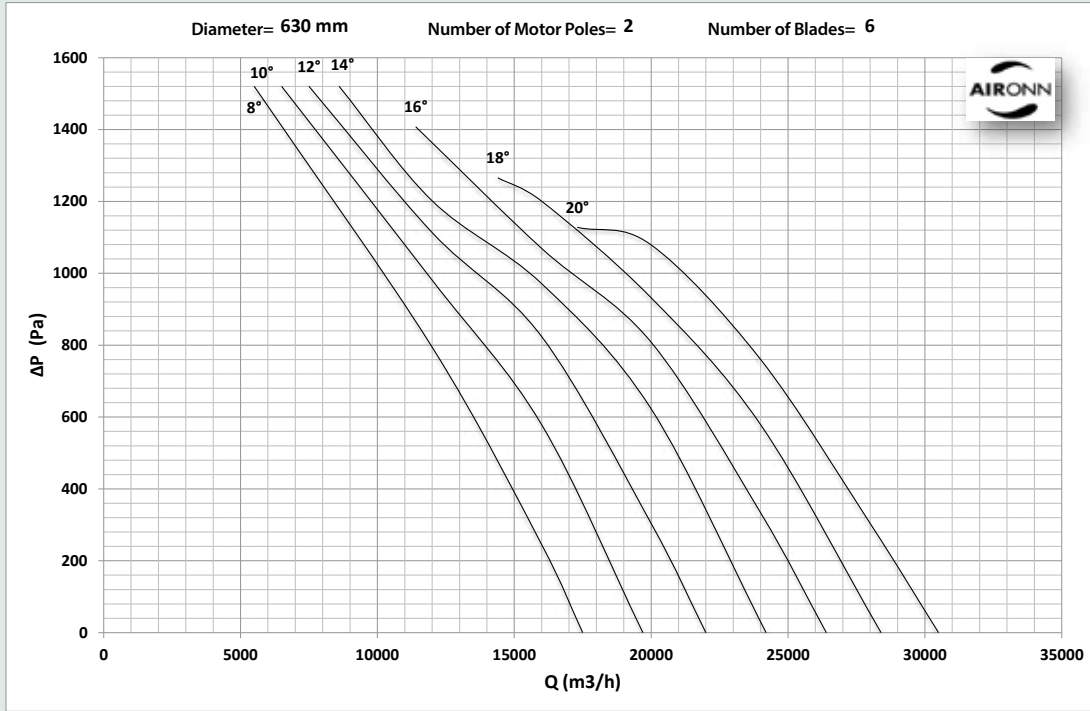

# Cell Type Axial Smoke Exhaust Fan Series

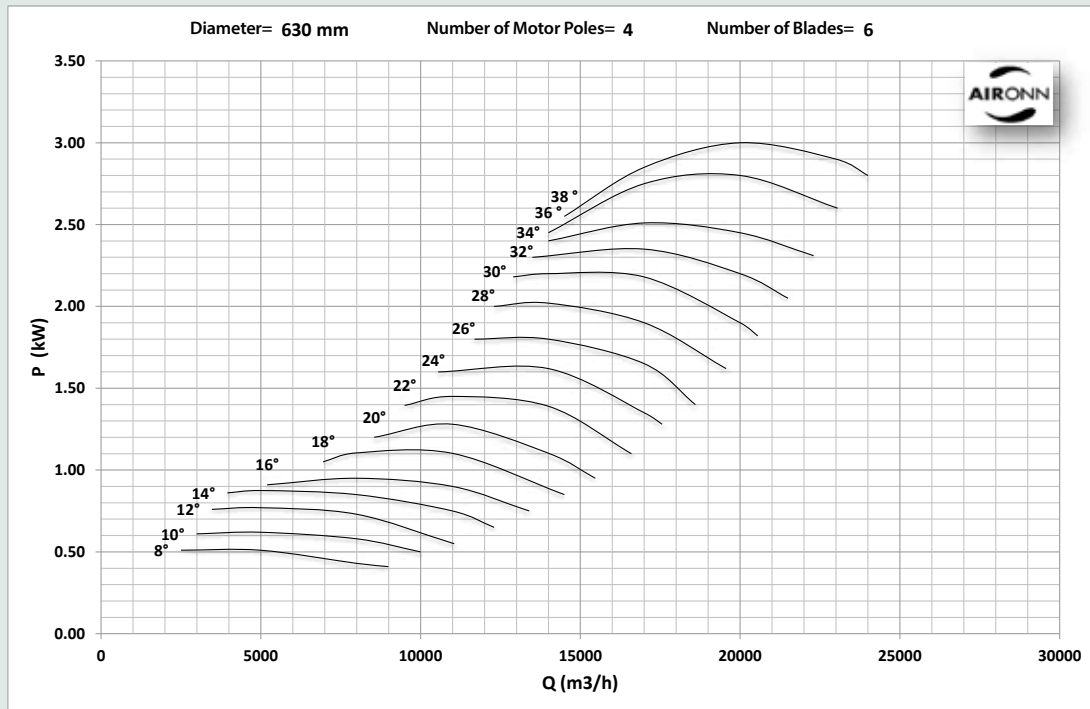
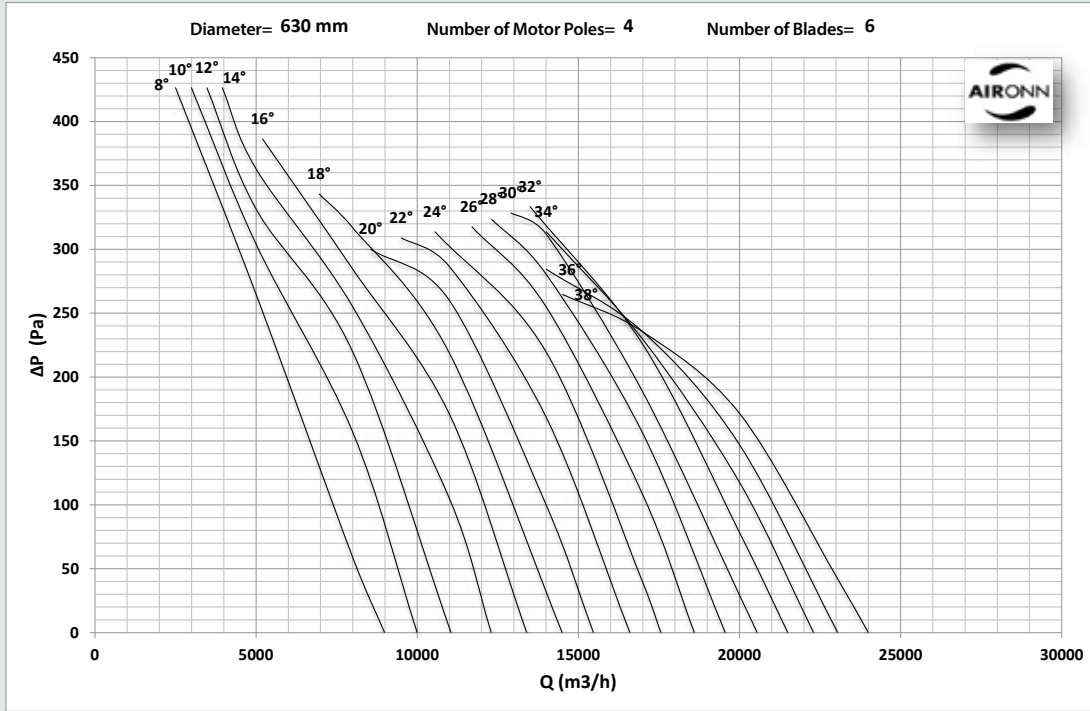

# Cell Type Axial Smoke Exhaust Fan Series

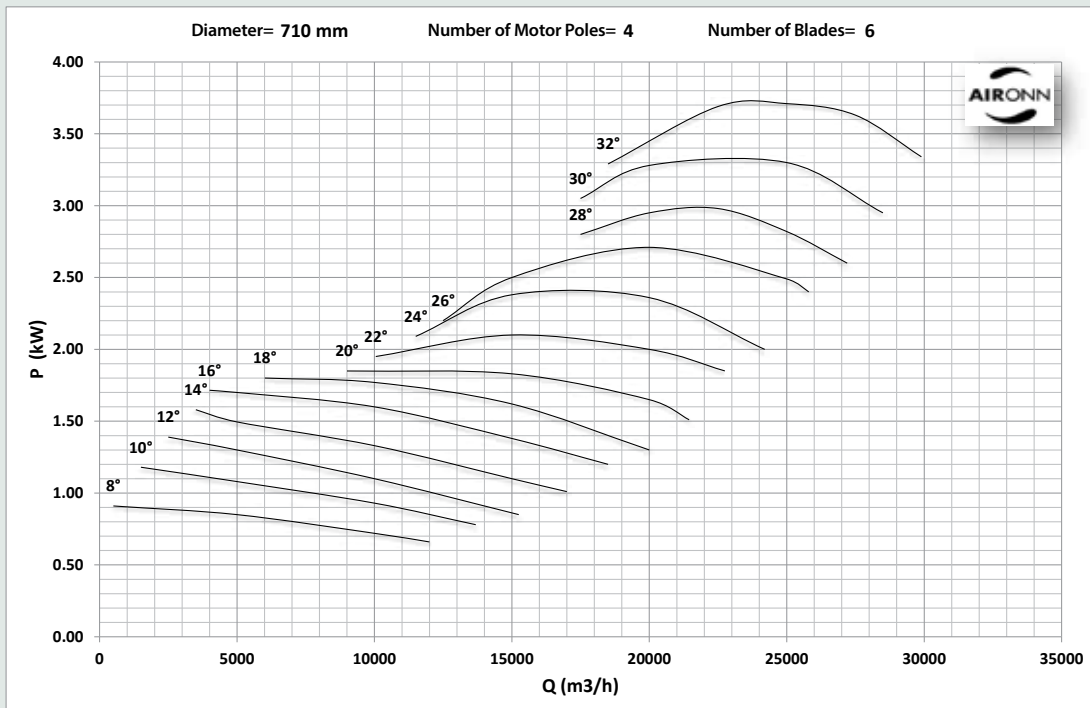
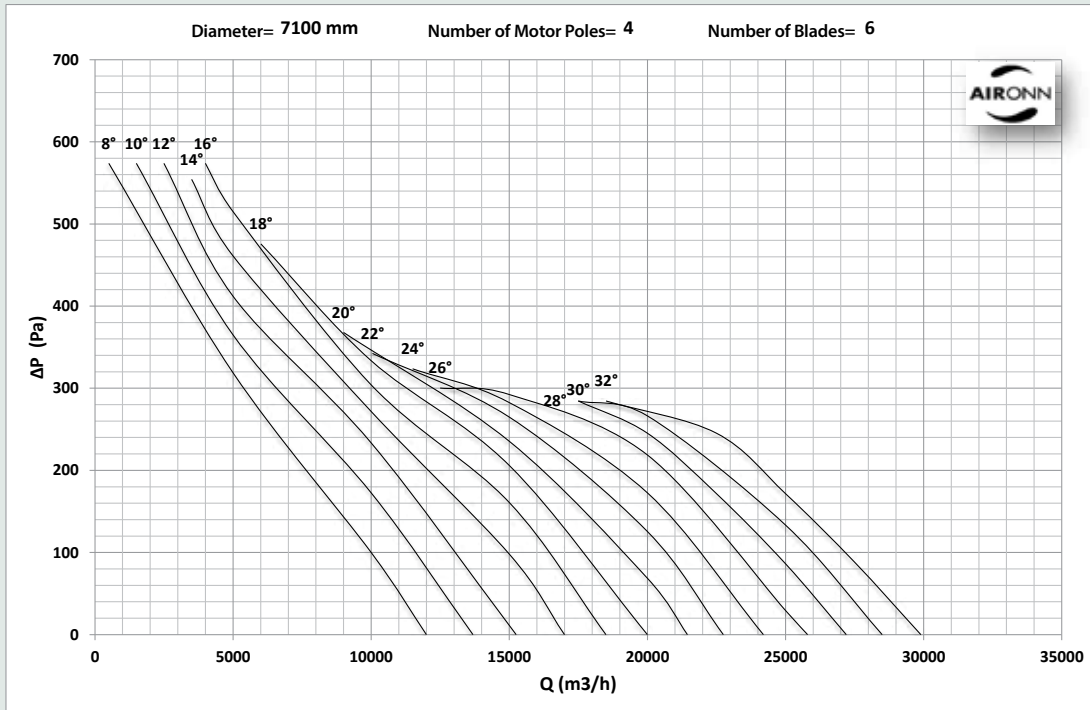

# Cell Type Axial Smoke Exhaust Fan Series

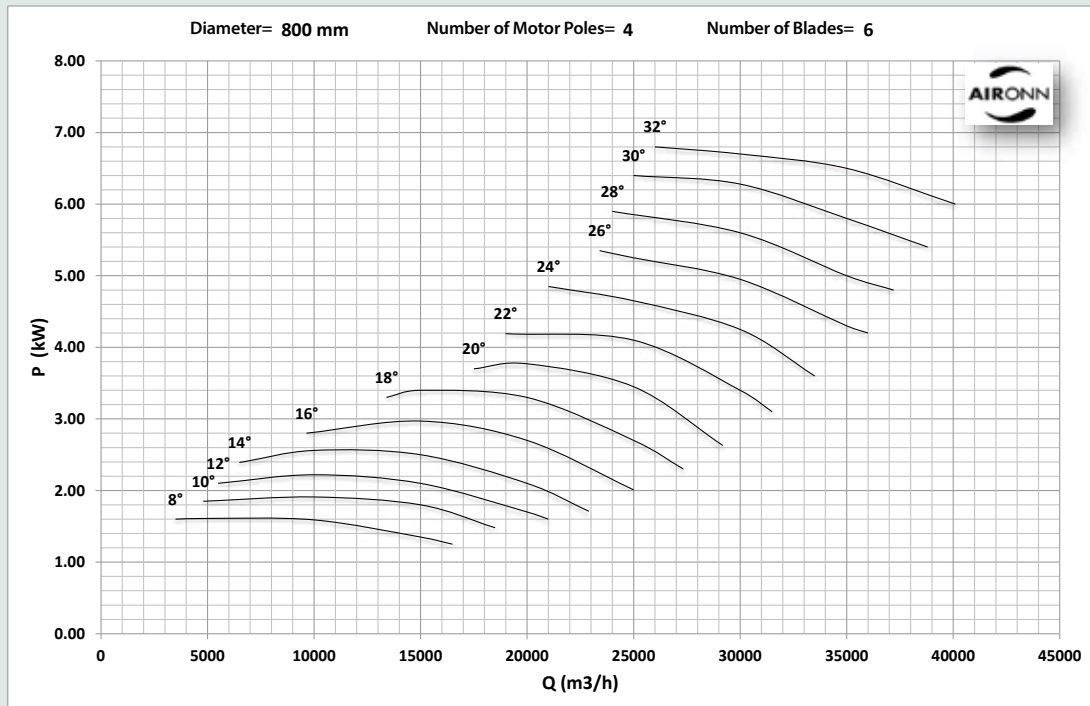
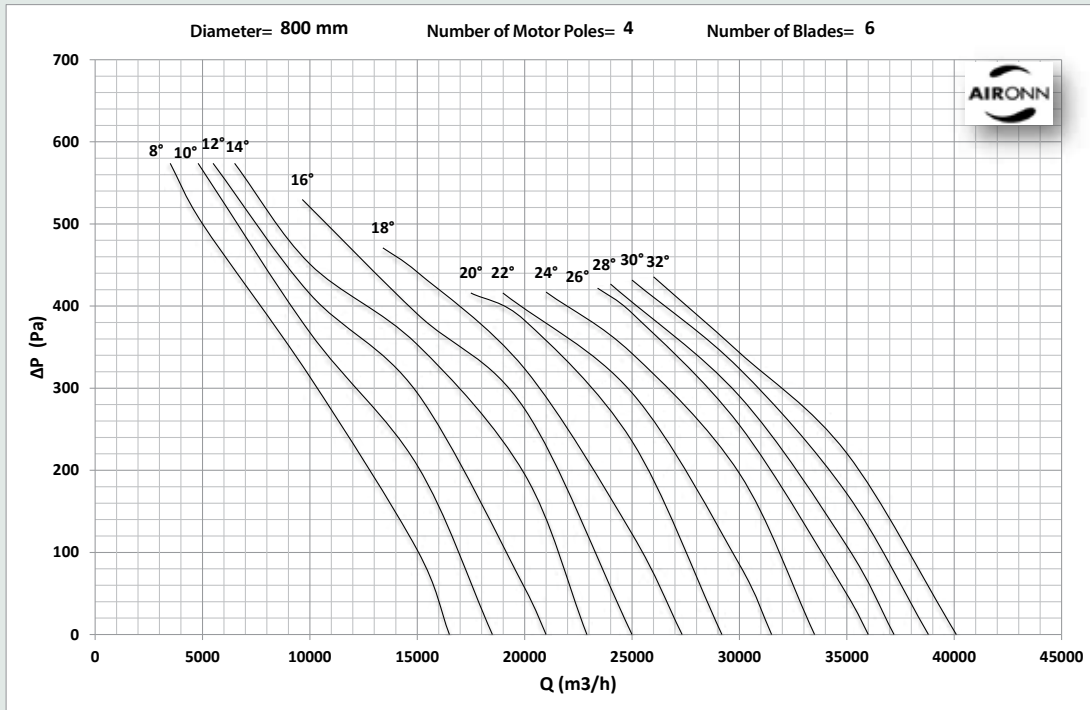

# Cell Type Axial Smoke Exhaust Fan Series

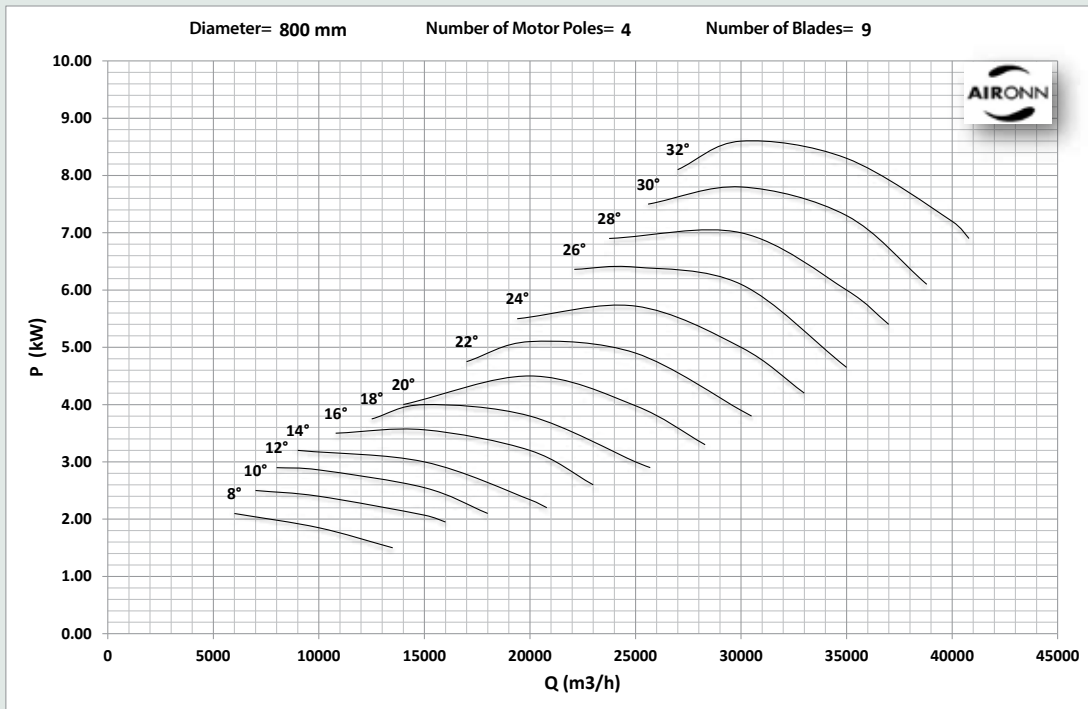
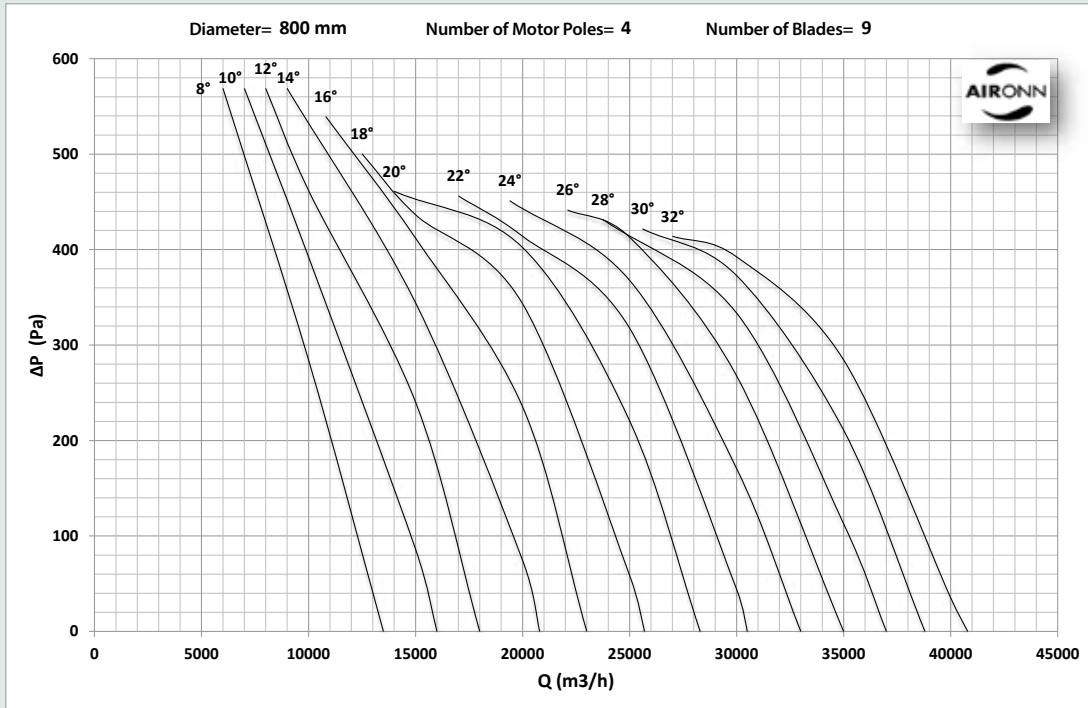

# Cell Type Axial Smoke Exhaust Fan Series

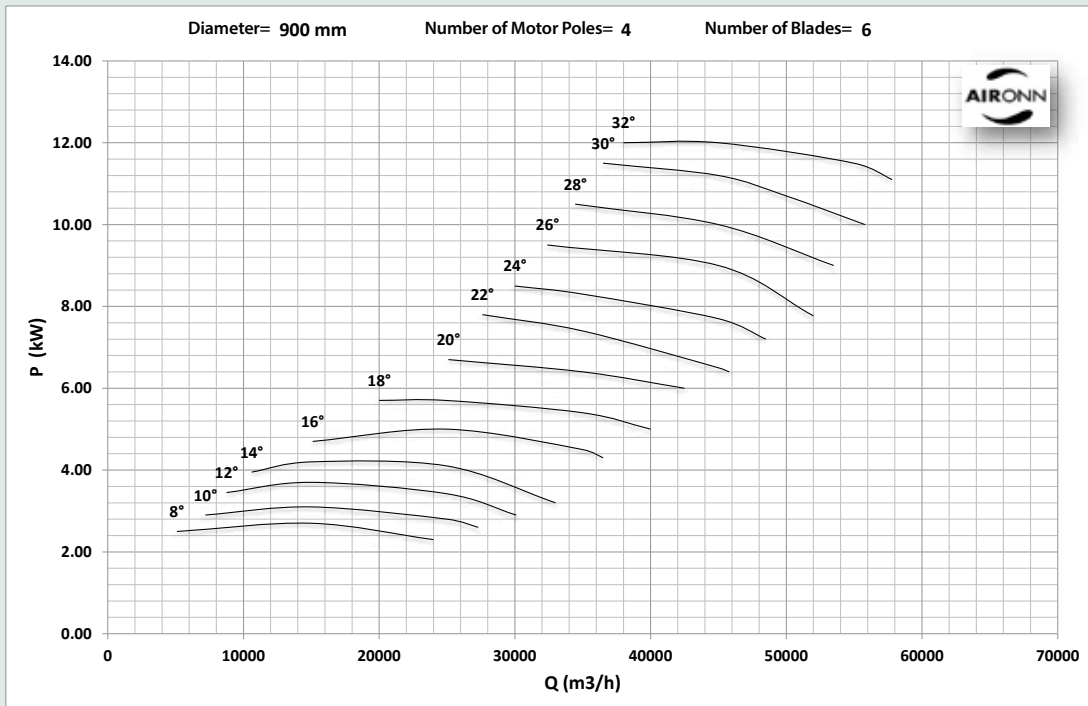
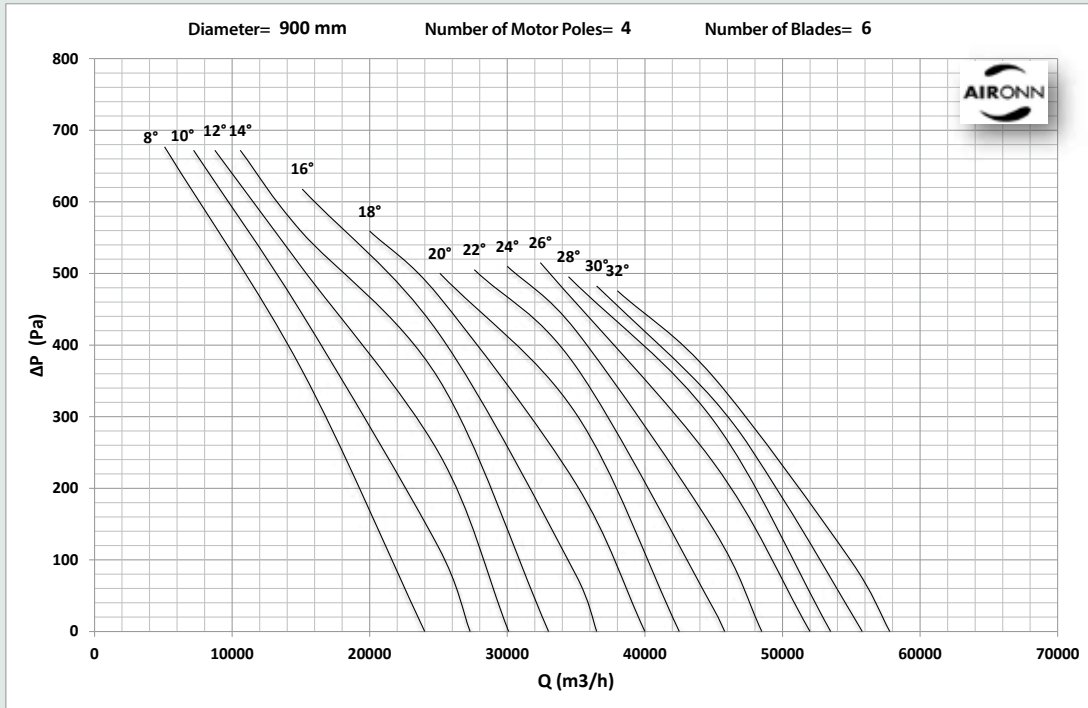

# Cell Type Axial Smoke Exhaust Fan Series

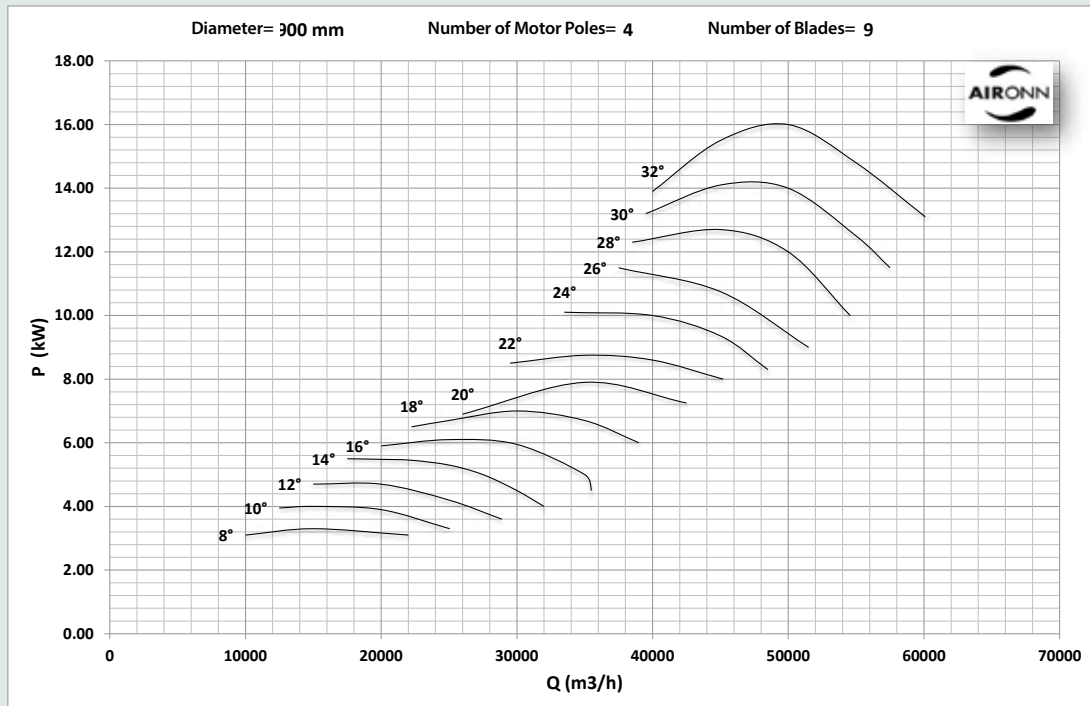
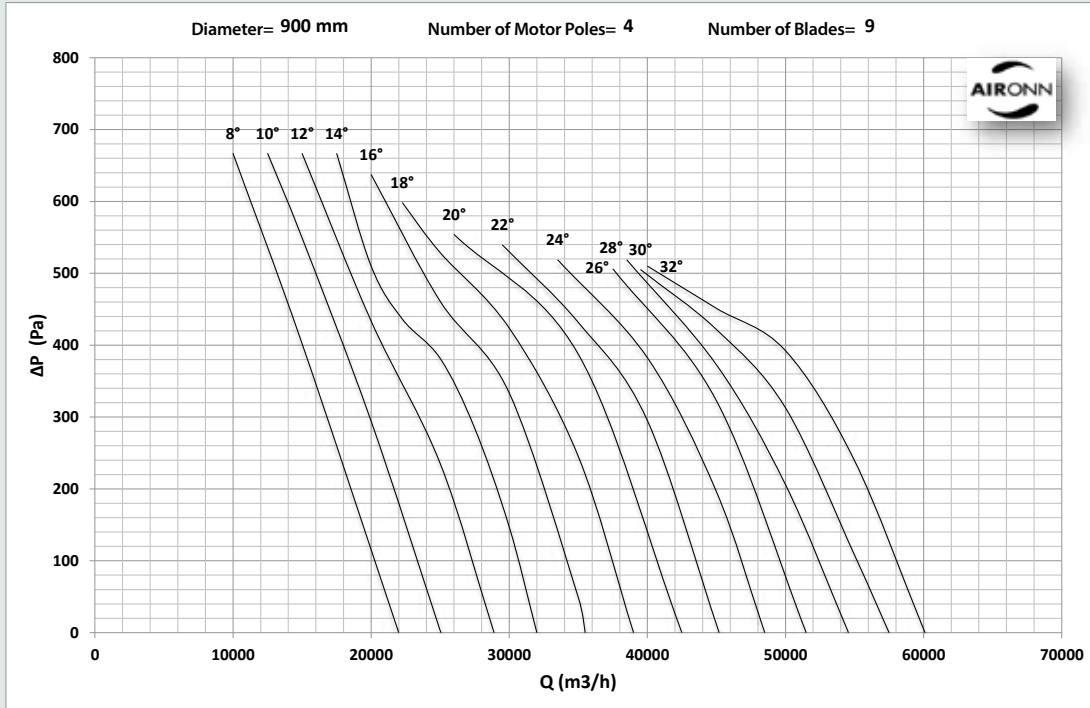

# Cell Type Axial Smoke Exhaust Fan Series

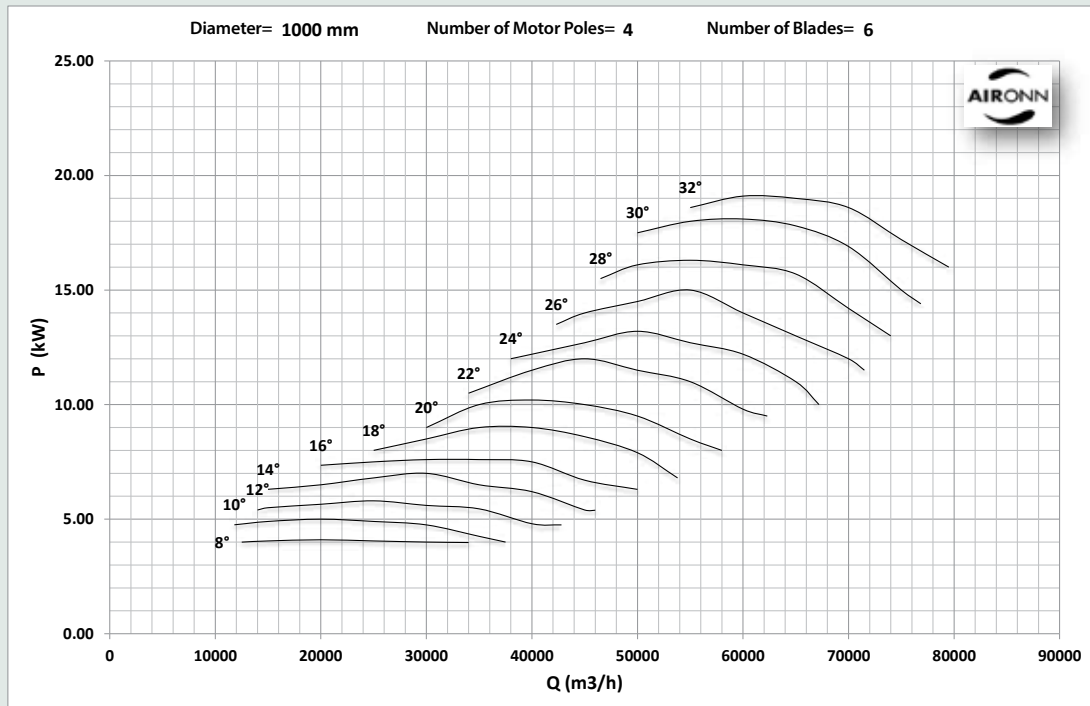
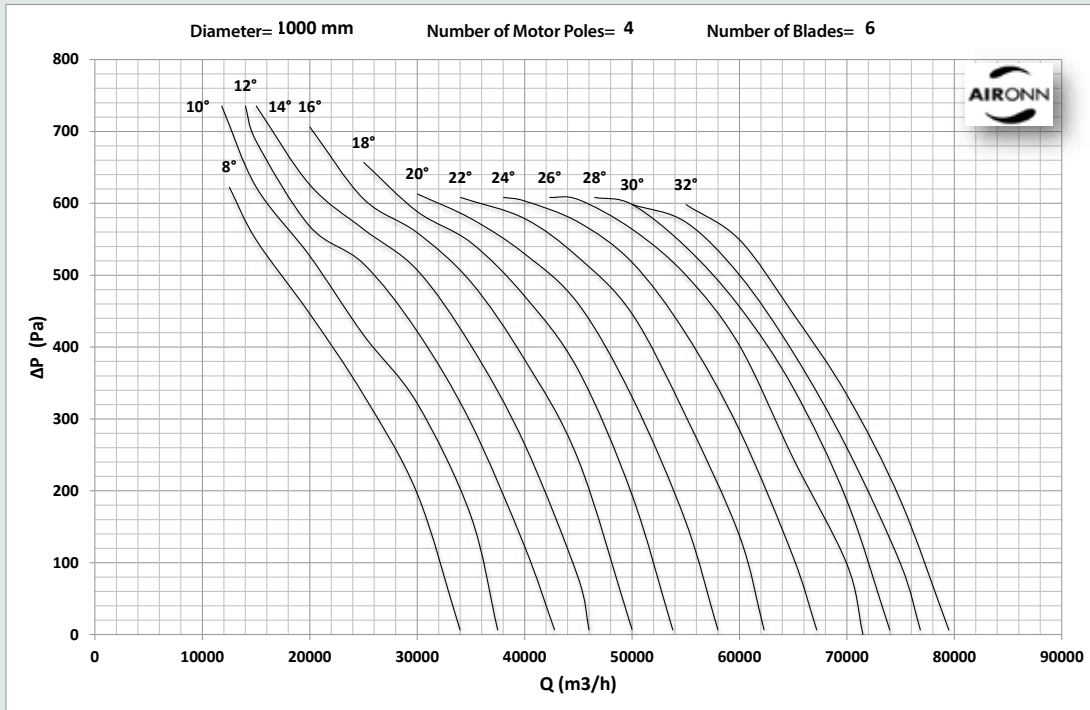



# Cell Type Axial Smoke Exhaust Fan Series

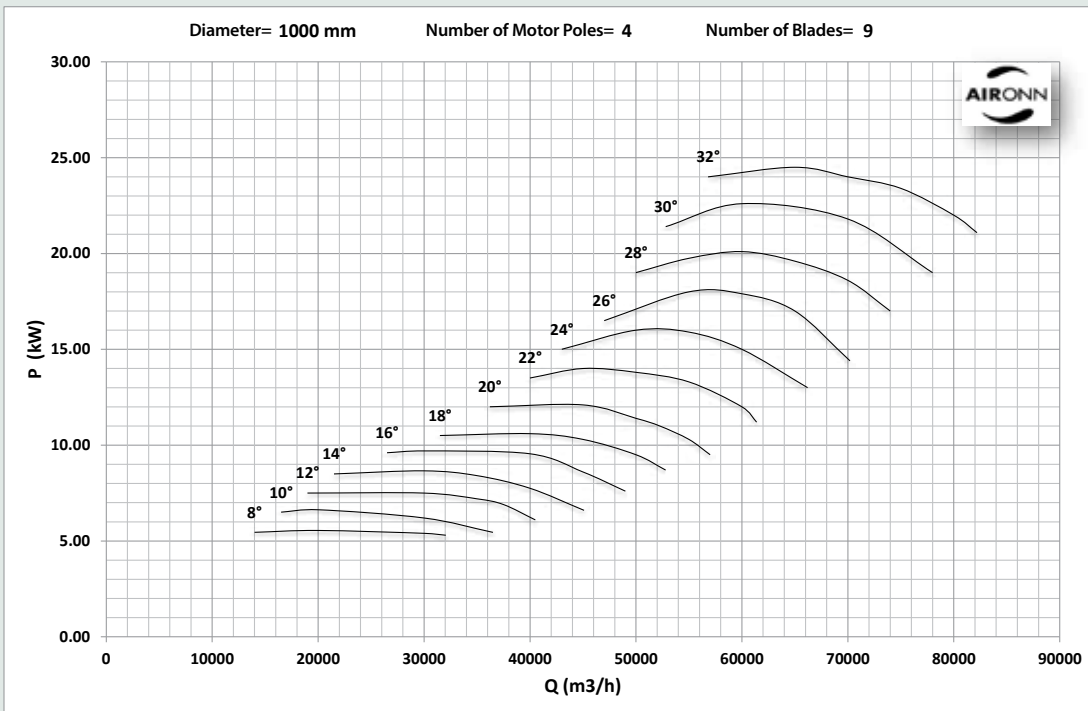
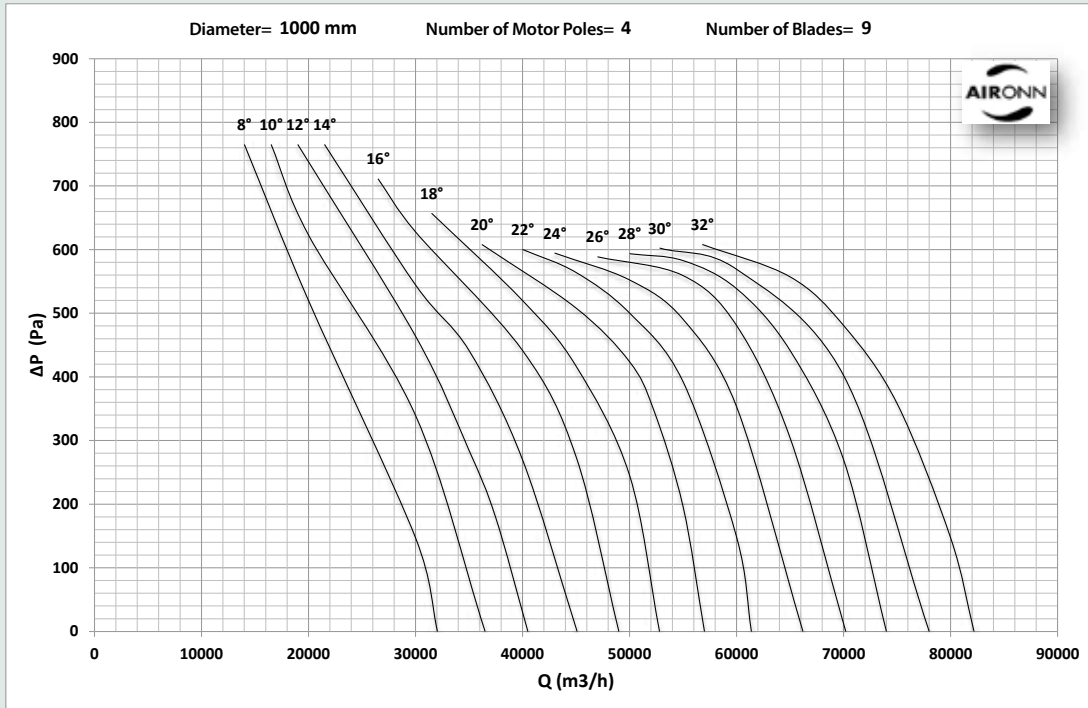

# Cell Type Axial Smoke Exhaust Fan Series

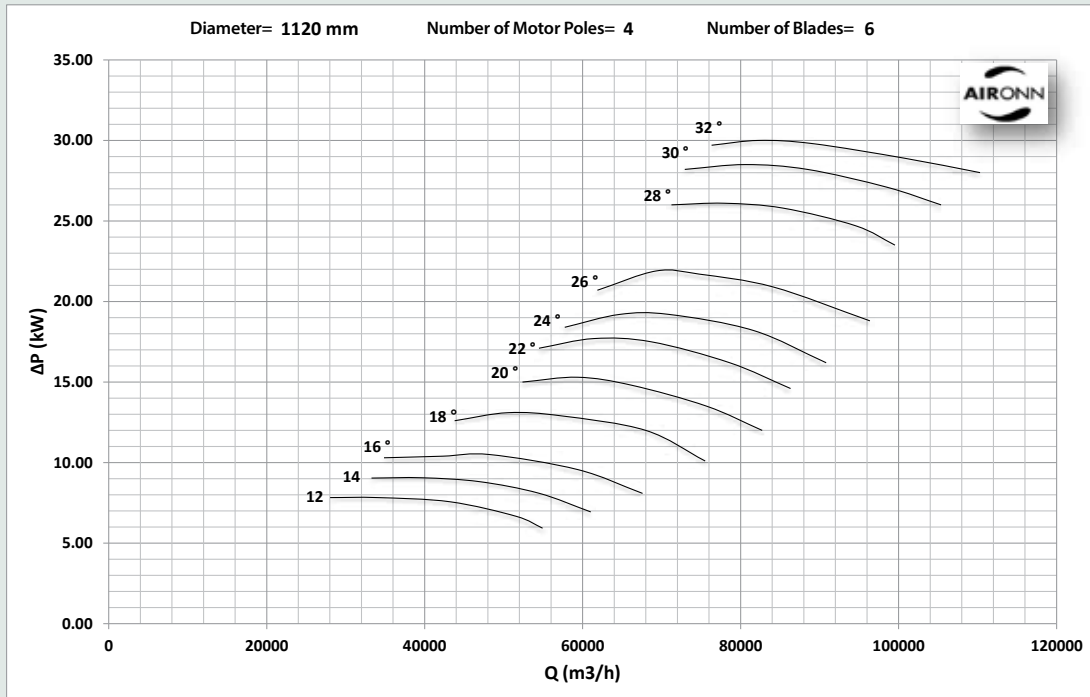
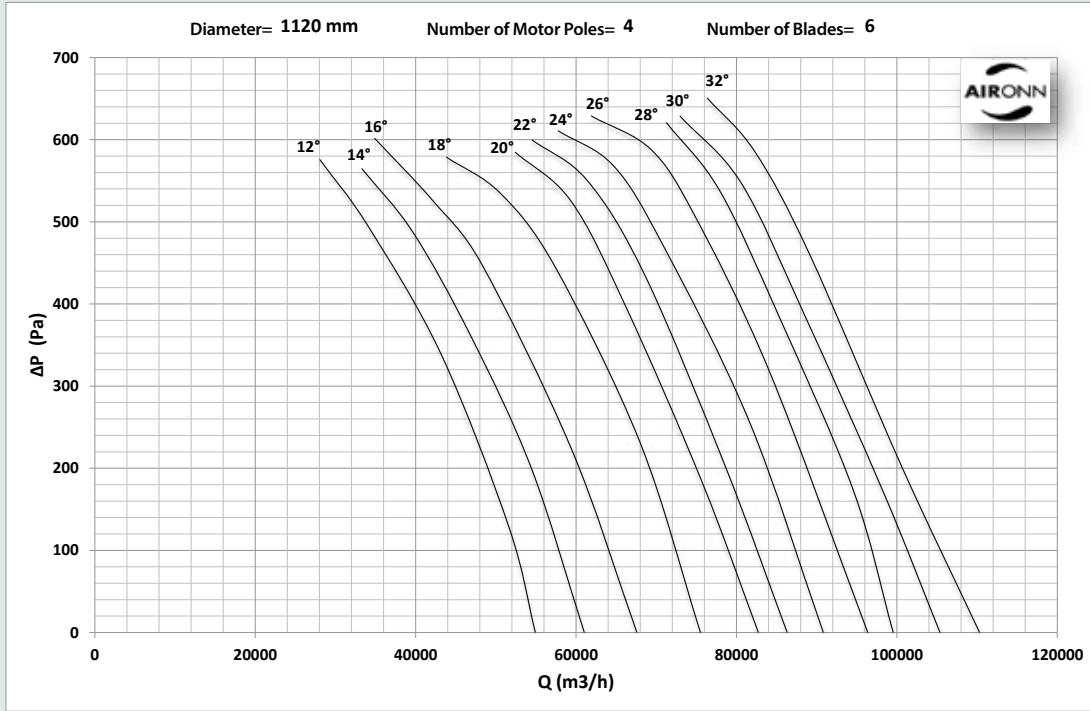

# Cell Type Axial Smoke Exhaust Fan Series

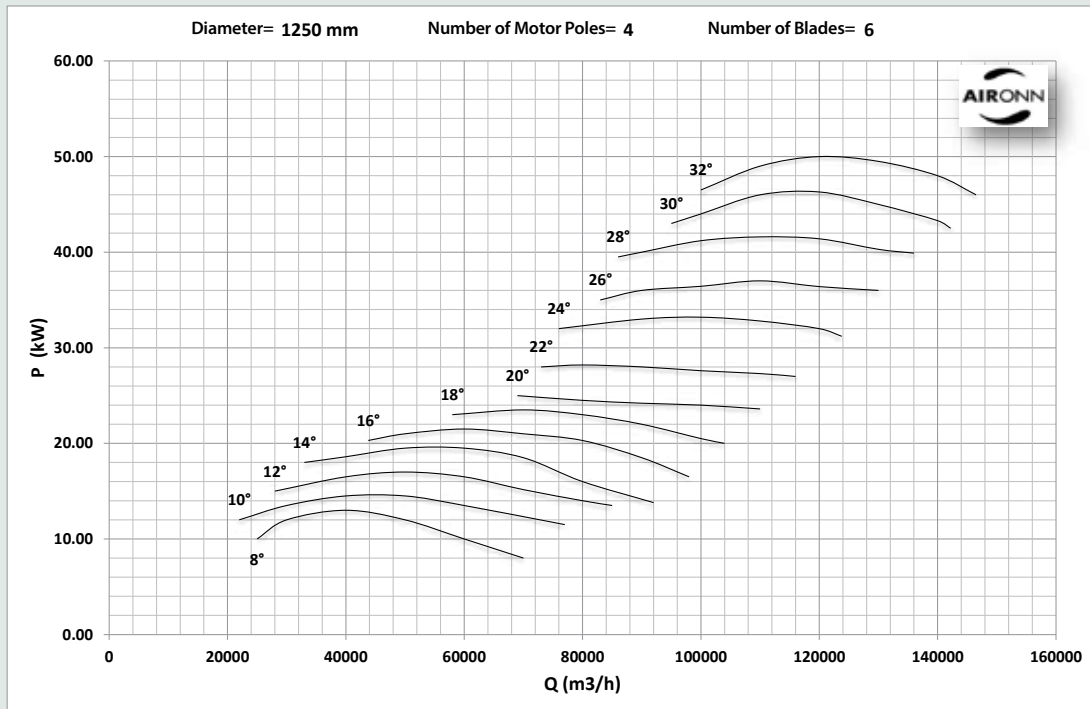
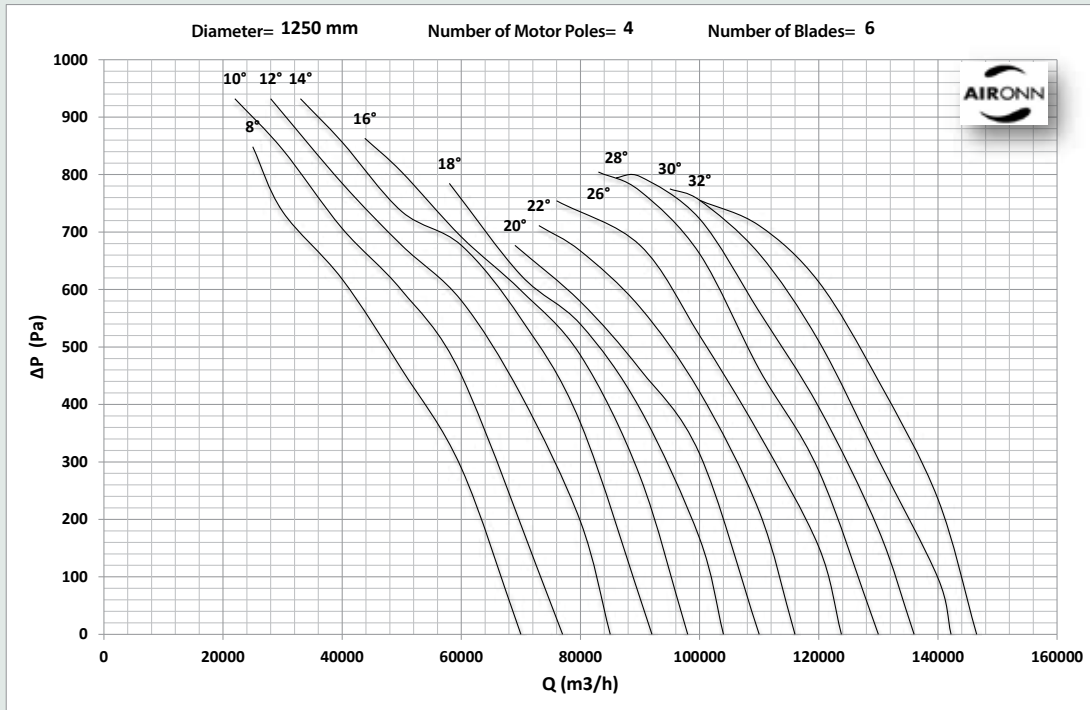

# Cell Type Axial Smoke Exhaust Fan Series

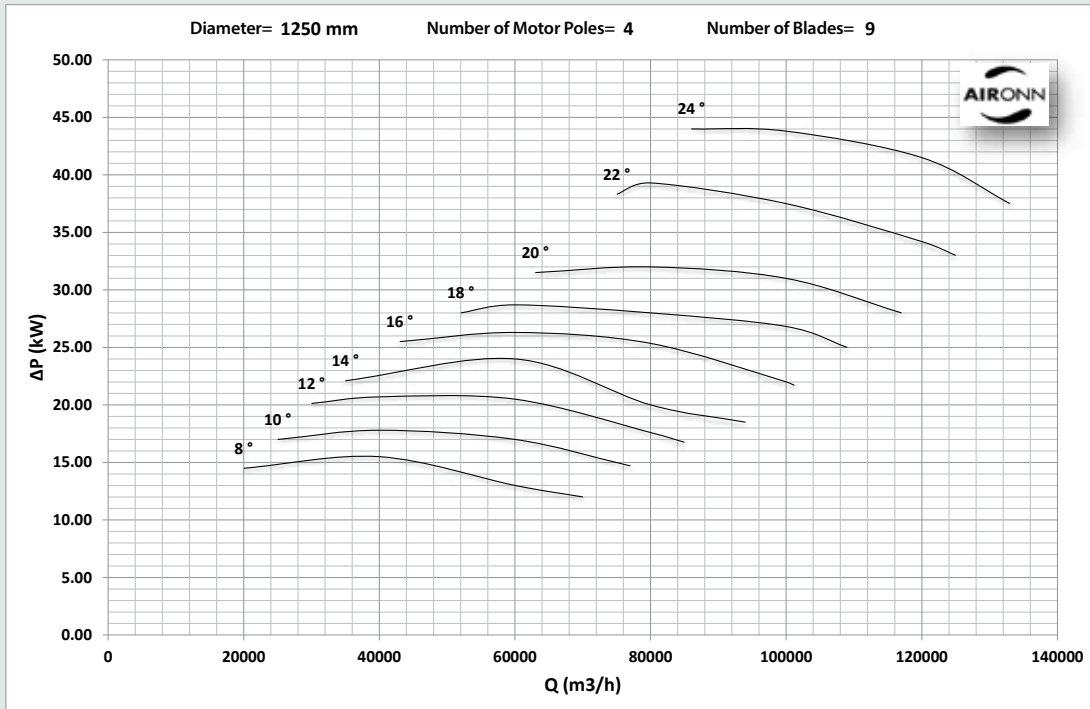
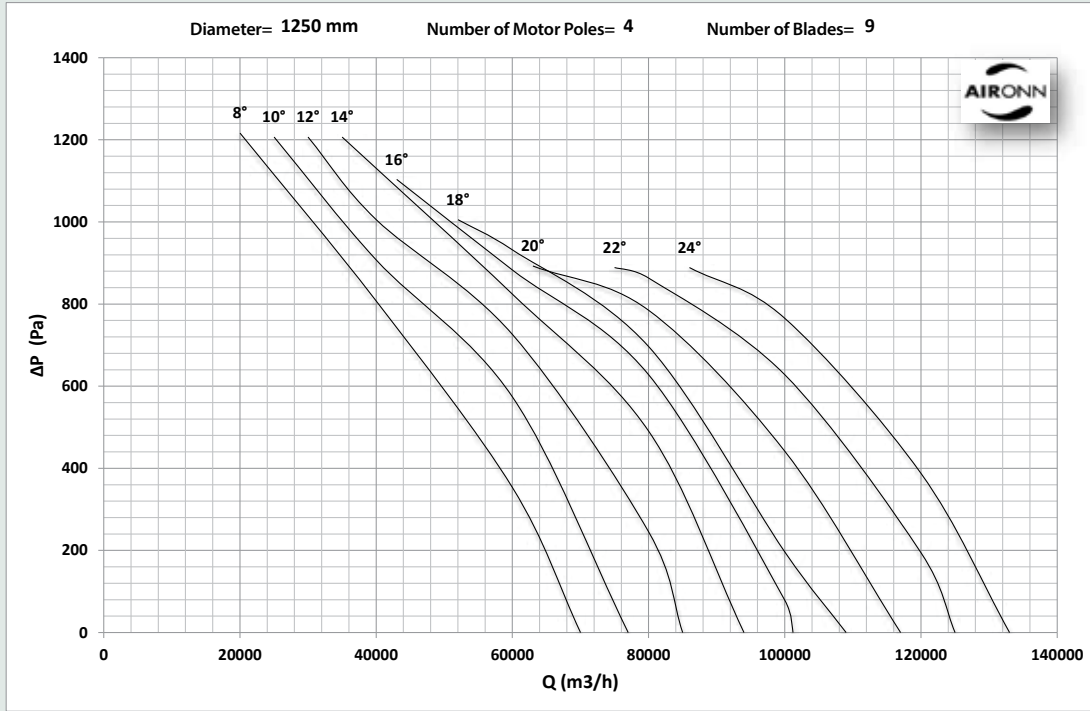



# Series Type Axial Smoke Exhaust Fan Series

Fans in the Aironn Series Type Axial Smoke Exhaust Fan series have 300 °C-2 hours and 400 °C-2 hours certificates in compliance with EN 12101-3. Adjustable edge angle of the series in the range of diameters between 400 mm and 1250 mm presents a broad performance range. It also comes into prominence with its feature to compensate high pressure losses. Performance of the fans in Series Type Axial Smoke Exhaust Fan Series have been tested in accordance with AMCA 210-07 standard.

## Fan Body

The body of the fans is made of high quality and corrosion resistant hot-dip galvanize coated sheet metal. The fan flanges are manufactured by bending the body so they are self flanged. Standard production is long-bodied. Body inspection hatch is optional.

## Fan Blades

Aerodynamic fan blades are made of ETIAL 171 with injection moulding method. They are statically and dynamically balanced in compliance with ISO 1940/1-2003.

## Motor

They have 2 IP 55 motors with class H insulation available in single cycle or double cycle options. If requested, single cycle motors can be used with inverters.

## Electricity

2 IP 55 electricity terminal boxes made of aluminium are standard.

## Accessories

Horizontal Mount Foot, Vertical Mount Foot, Silencer (50), Silencer (100), Silencer with Pod (100), Counter Flange, Protection Grill, Back Draft Damper, Spring Insulator, Inlet Cone, Flexible Coupling, Pacco (Package) Switch, Vibration Sensor, Inverter



## Series Type Axial Fresh Air Fan Series

Fans in Aironn Series Type Fresh Air Fan Series are suitable to operate at maximum 55 °C. Adjustable edge angle of the series in the range of diameters between 400 mm and 1250 mm presents a broad performance range. It also comes into prominence with its feature to compensate high pressure losses. Performance of the fans in Series Type Axial Fresh Air Fan Series have been tested in accordance with AMCA 210-07 standard.

### Fan Body

The body of the fans is made of high quality and corrosion resistant hot-dip galvanize coated sheet metal. The fan flanges are manufactured by bending the body so they are self flanged. Standard production is long-bodied. Body inspection hatch is optional.

### Fan Blades

Aerodynamic fan blades are made of ETIAL 171 with injection moulding method. They are statically and dynamically balanced in compliance with ISO 1940/1-2003.

### Motor

They have 2 IP 55 motors with class F insulation available in single cycle or double cycle options. If requested, single cycle motors can be used with inverters.

### Electricity

2 IP 55 electricity terminal boxes made of plastic are standard.

### Accessories

Horizontal Mount Foot, Vertical Mount Foot, Silencer (50), Silencer (100), Silencer with Pod (100), Counter Flange, Back Draft Damper, Protection Grill, Spring Insulator, Inlet Cone, Flexible Coupling, Pacco (Package) Switch, Vibration Sensor, Inverter



## Series Type Axial Smoke Exhaust & Fresh Air Fan Series

### Dimensions

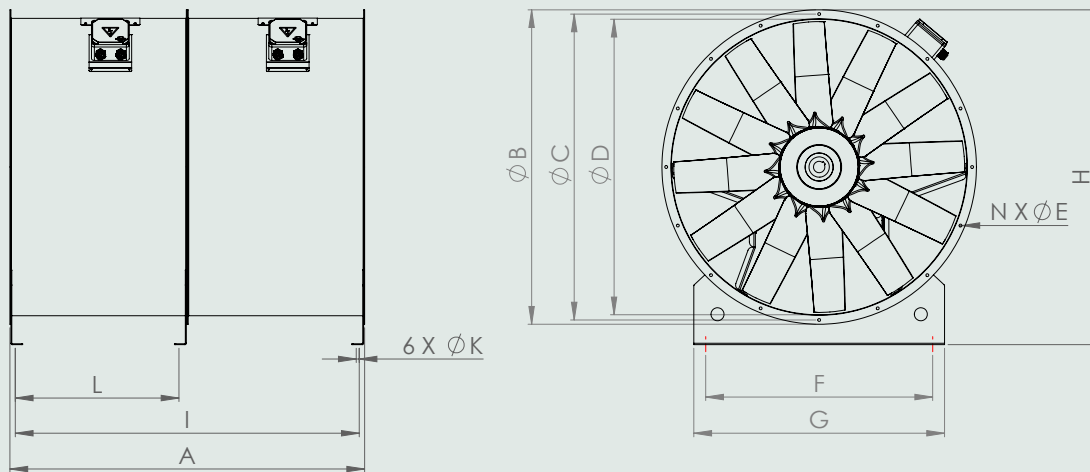

	A	B	C	D	F	G	L	H	I	N X Ø E	4 X Ø K
400	840	460	430	400	300	360	378	500	798	8 x 11	11
450	840	510	484	450	320	400	378	550	798	8 x 11	11
500	840	560	537	500	370	450	378	600	798	8 x 11	11
560	840	620	597	560	420	500	378	670	798	8 x 11	11
630	940	590	667	630	460	540	428	790	898	8 x 11	11
710	1000	770	747	710	500	600	458	870	958	8 x 11	11
800	1160	880	844	800	580	680	538	970	1118	16 x 11	11
900	1400	980	944	900	660	760	644	1070	1344	16 x 13	13
1000	1550	1080	1044	1000	750	850	717	1167	1492	16 x 13	13
1250	1550	1330	1294	1250	960	1060	717	1417	1492	16 x 13	13



## Series Type Axial Fresh Air Fan Series

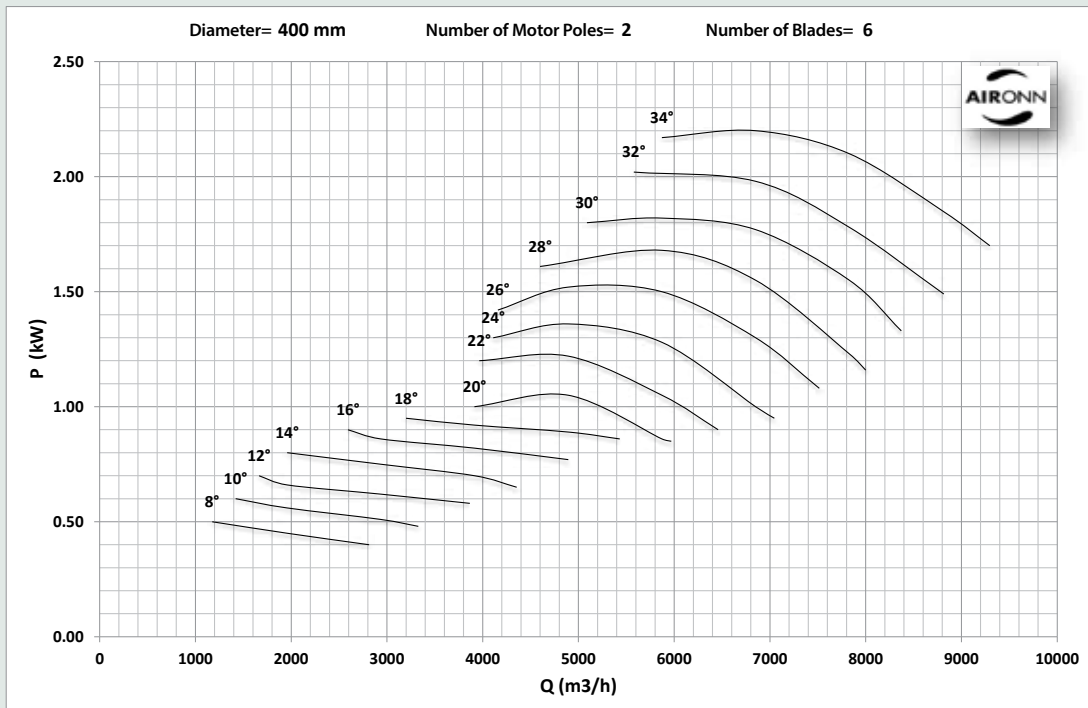
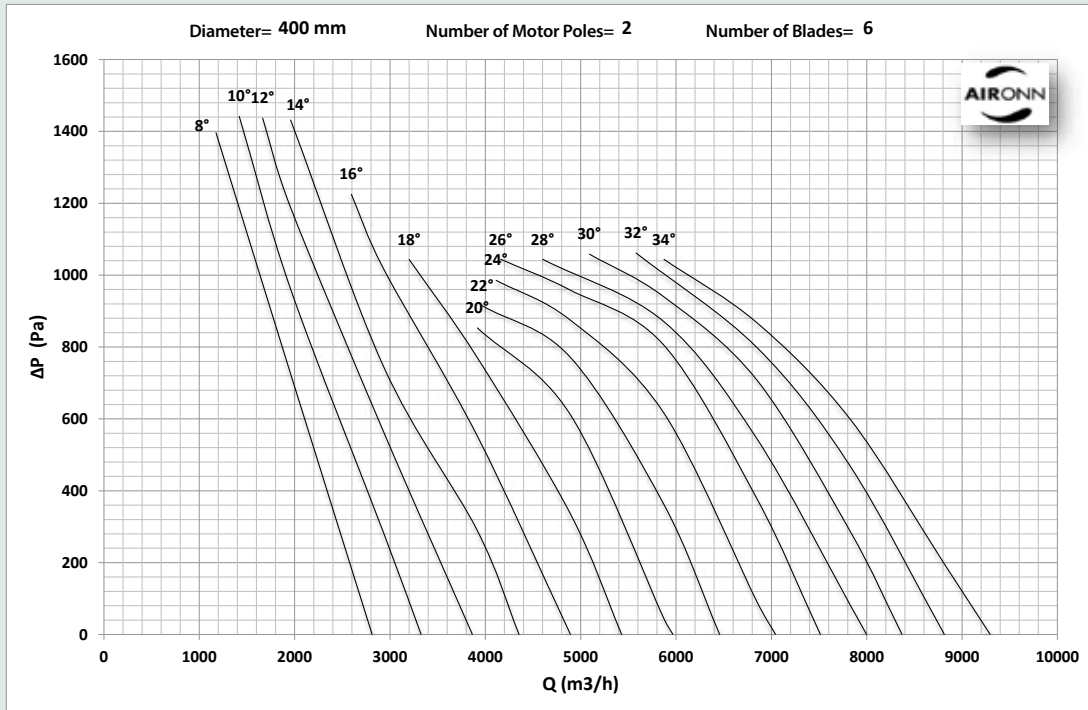

## Series Type Axial Fresh Air Fan Series

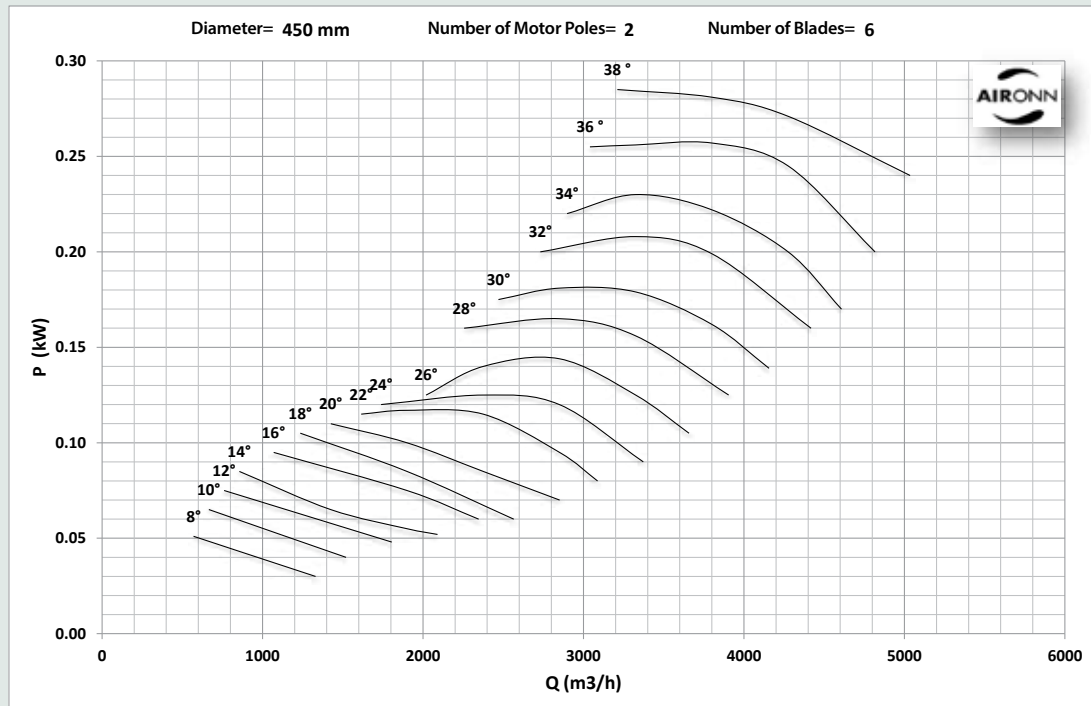
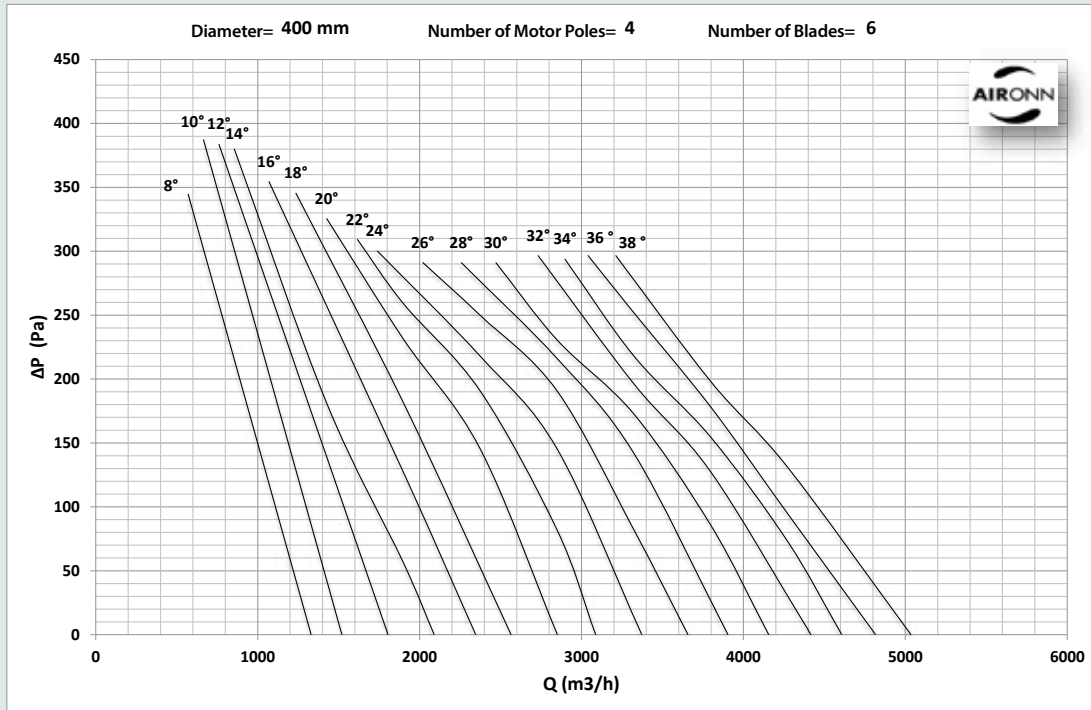

## Series Type Axial Fresh Air Fan Series

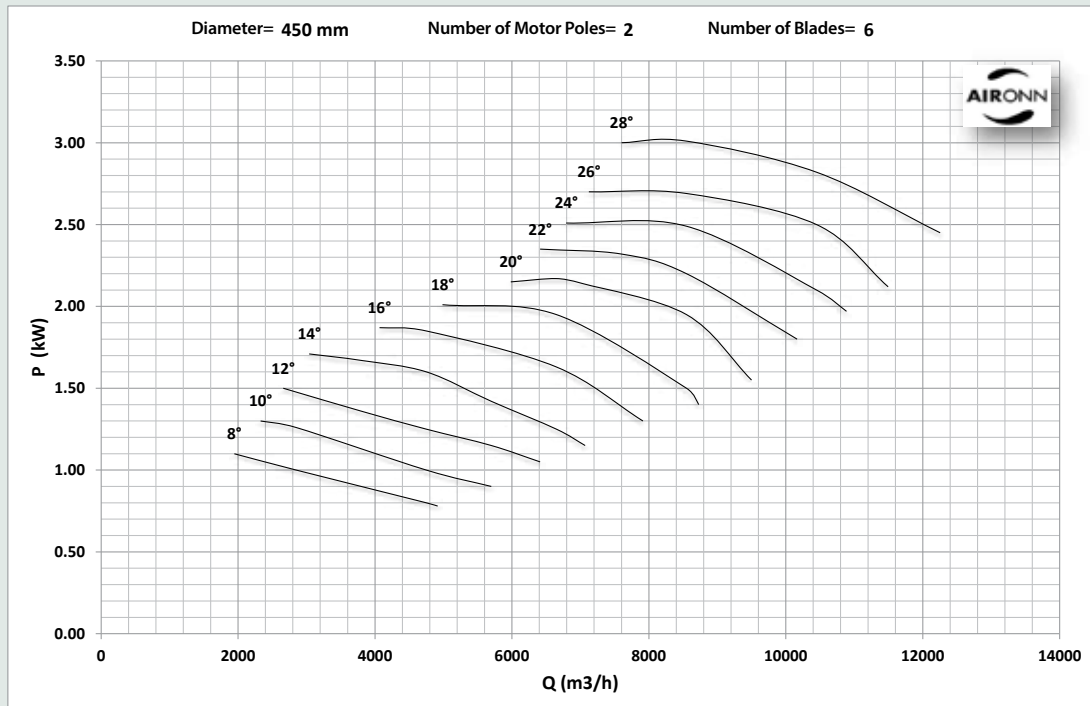
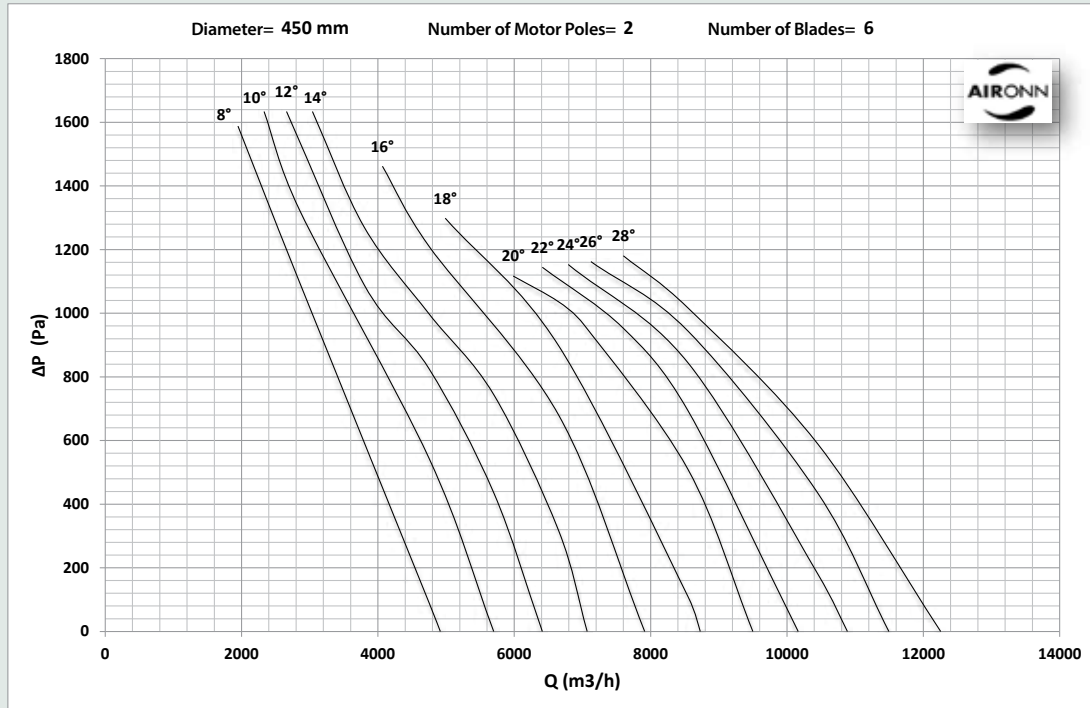

## Series Type Axial Fresh Air Fan Series

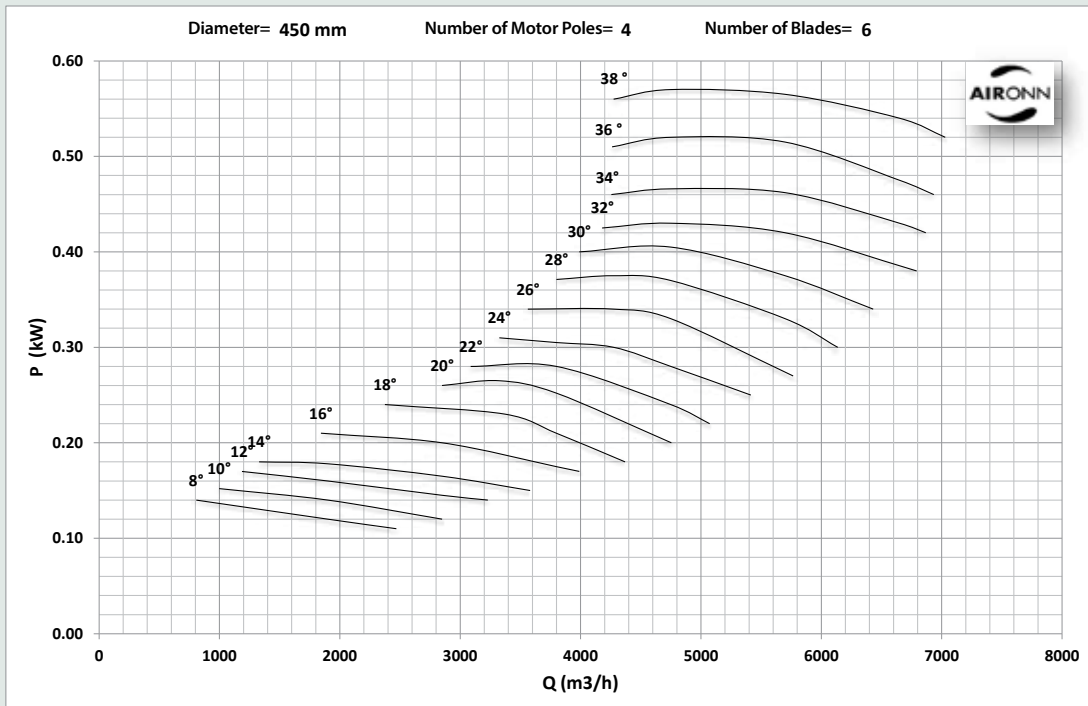
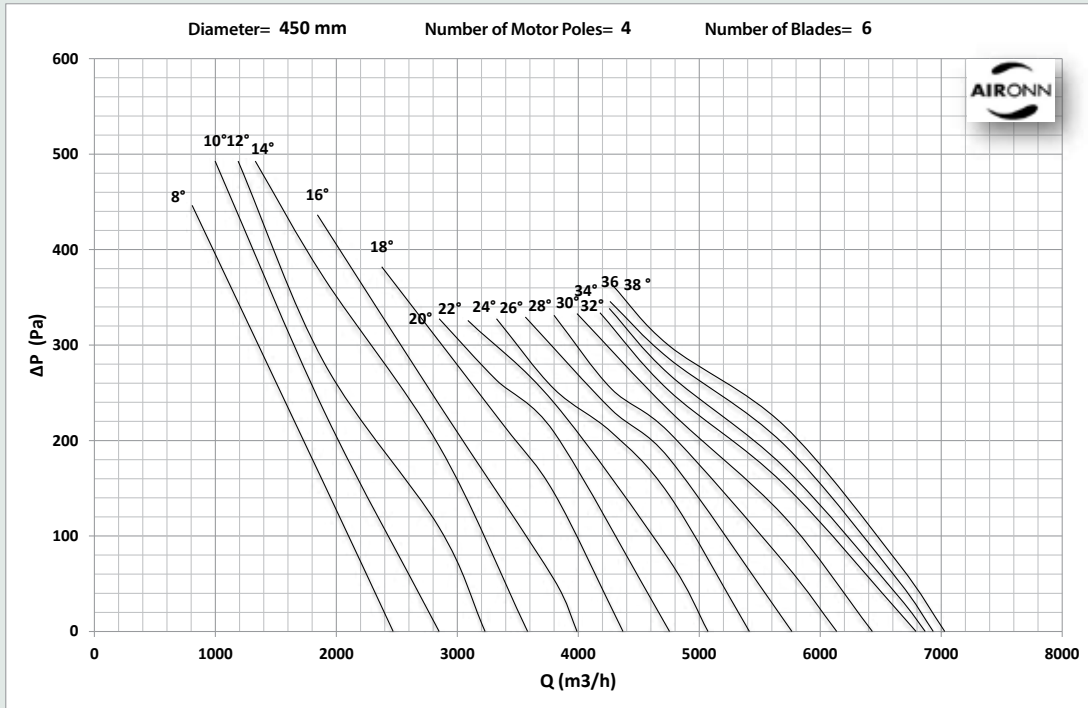

## Series Type Axial Fresh Air Fan Series

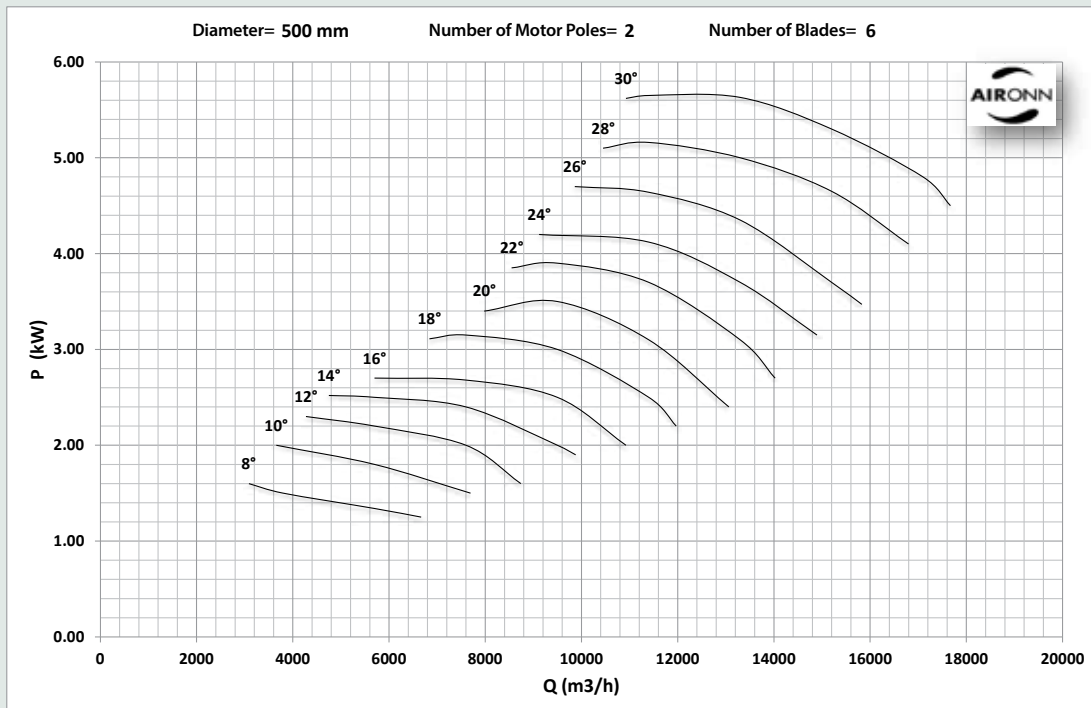
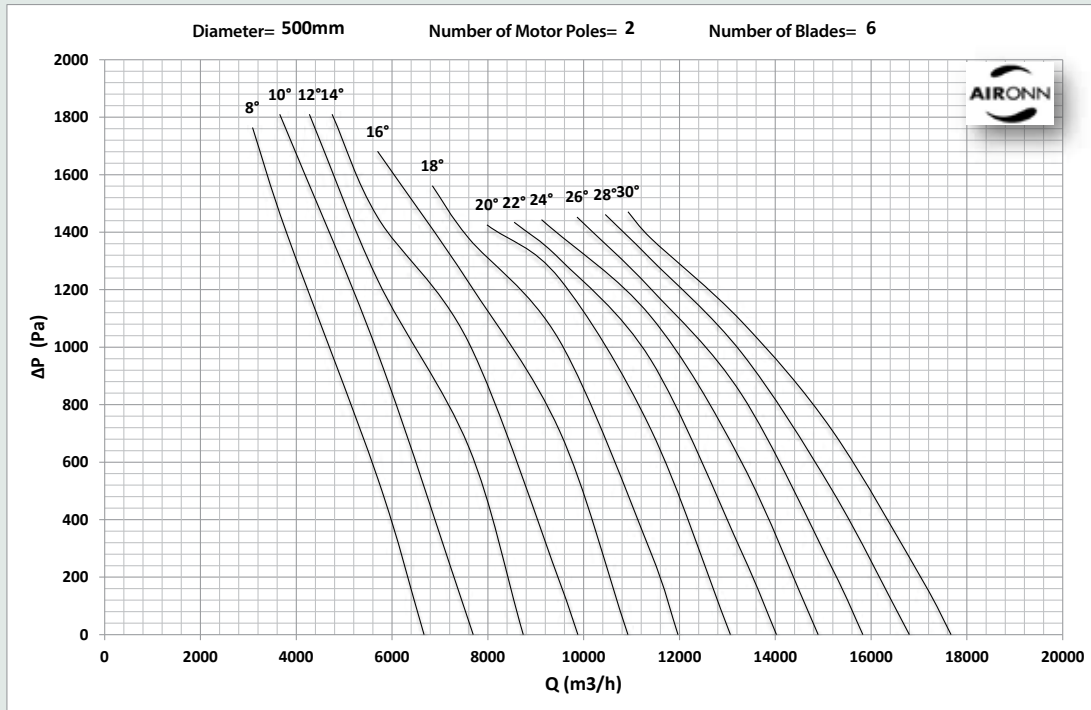

## Series Type Axial Fresh Air Fan Series

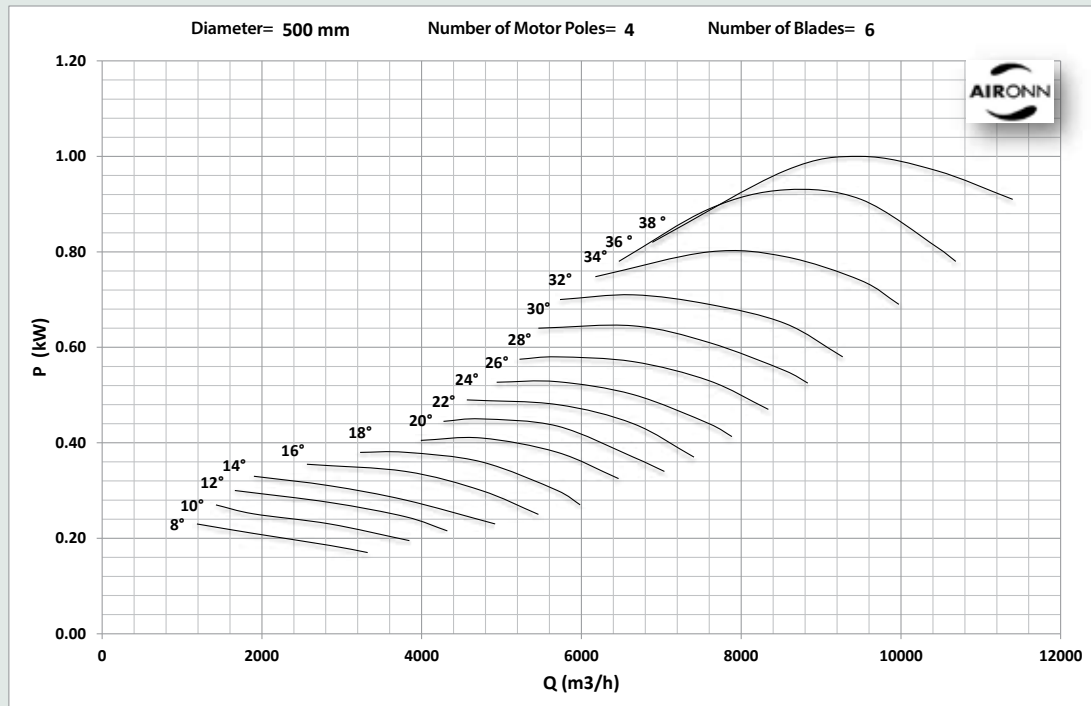
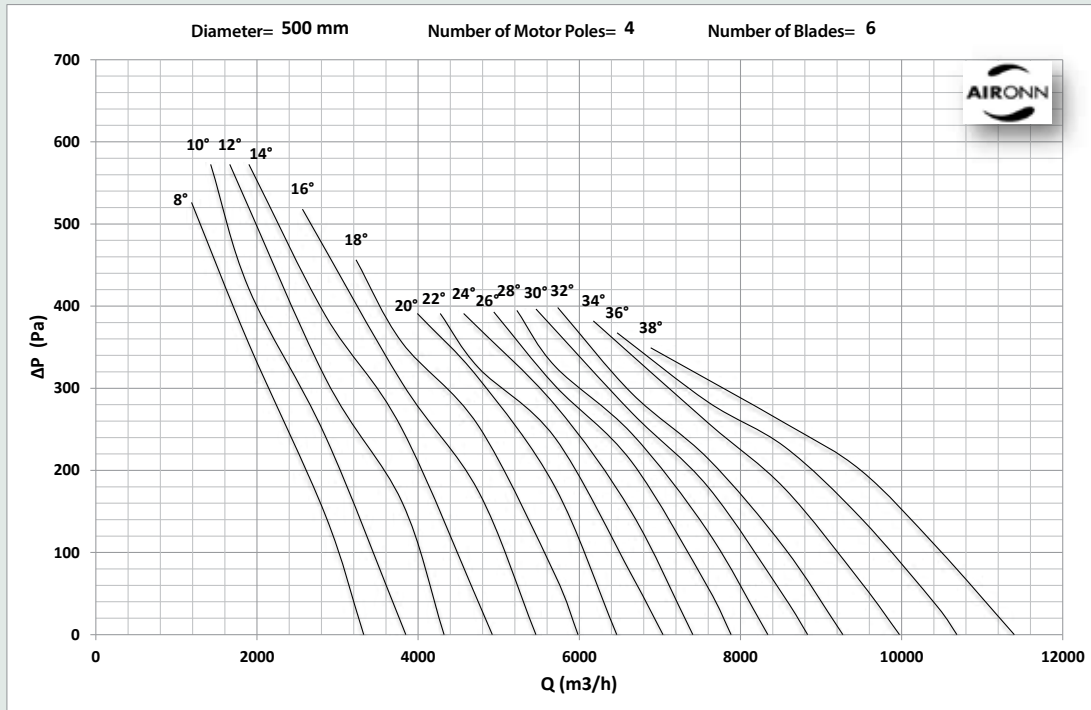

## Series Type Axial Fresh Air Fan Series

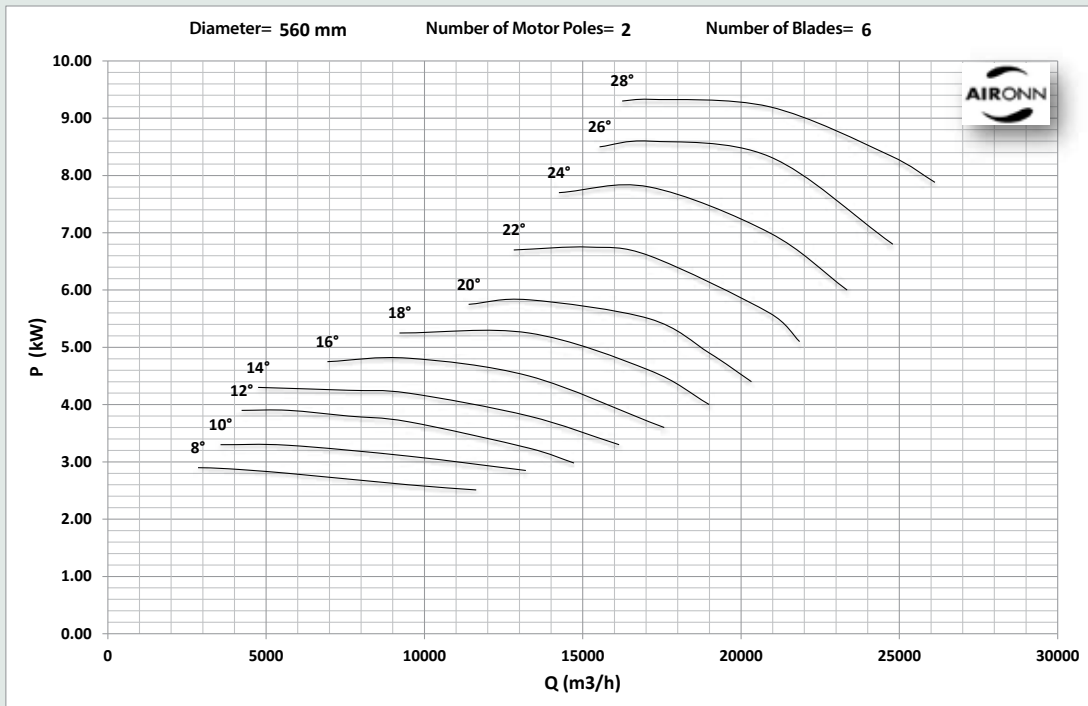
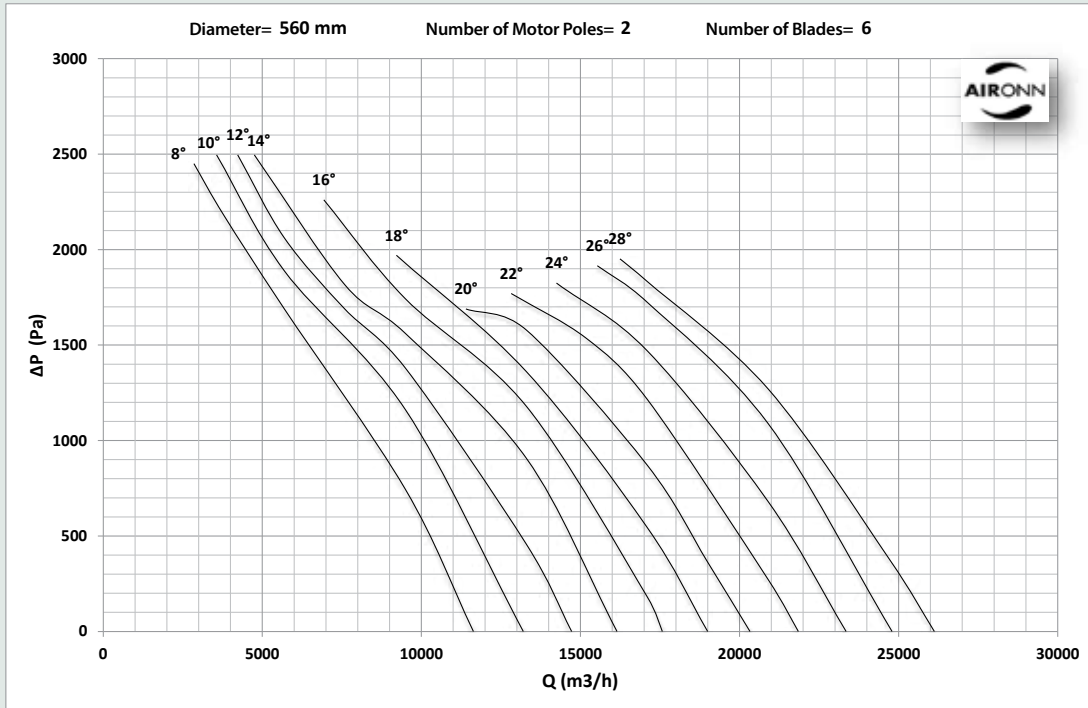

## Series Type Axial Fresh Air Fan Series

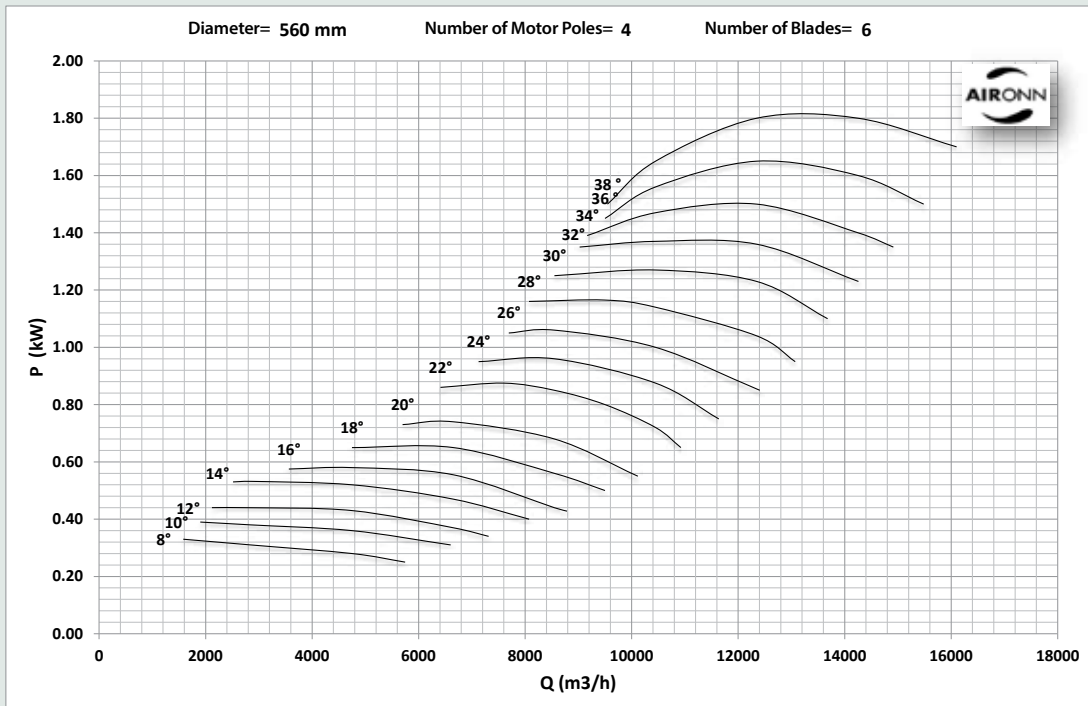
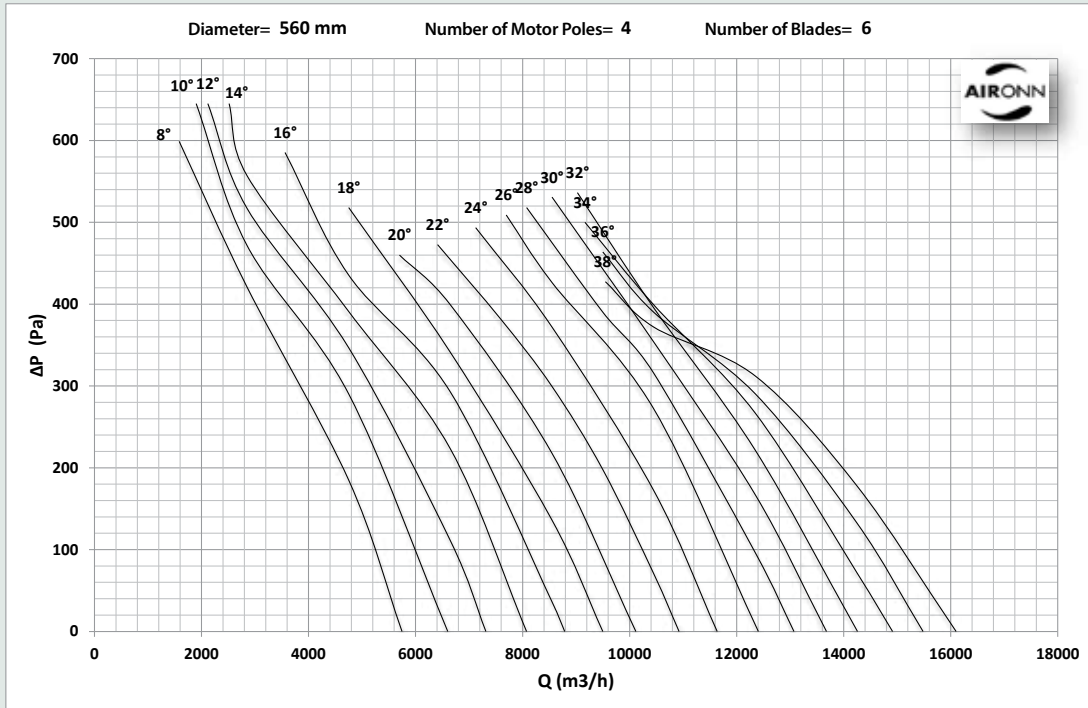



## Series Type Axial Fresh Air Fan Series

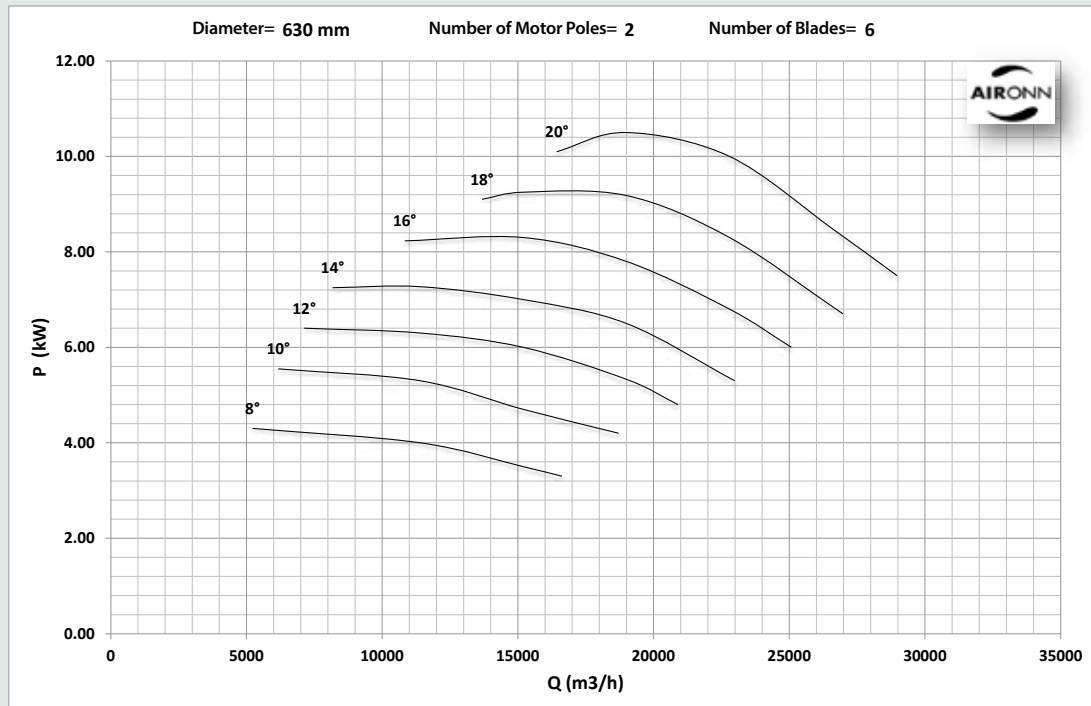
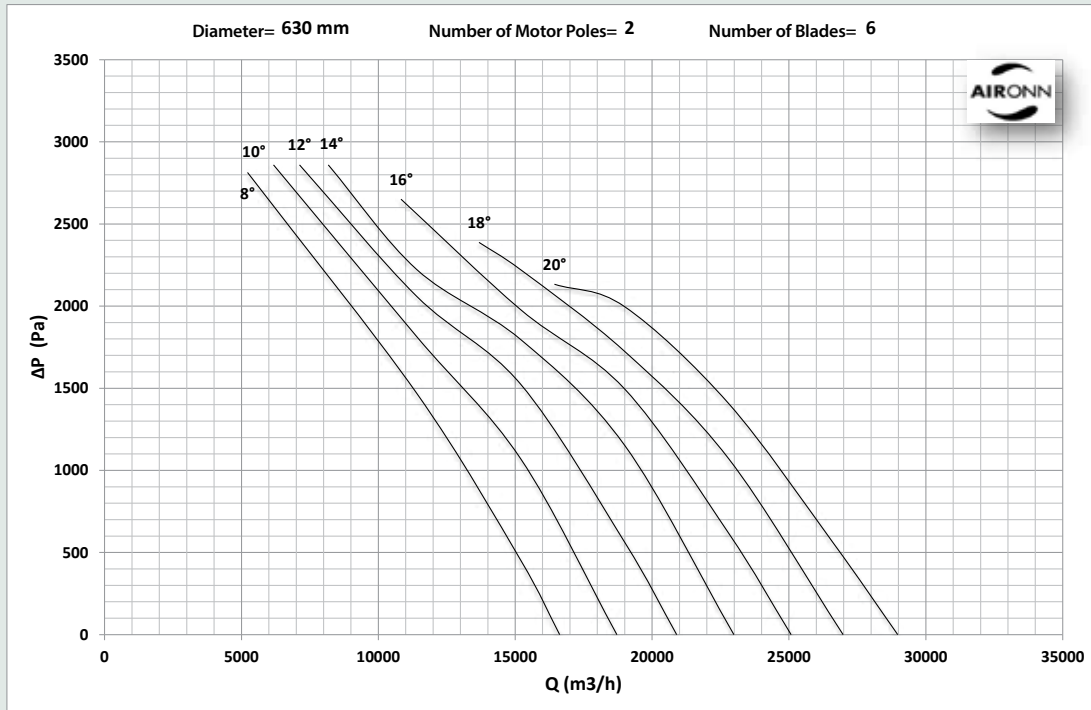

## Series Type Axial Fresh Air Fan Series

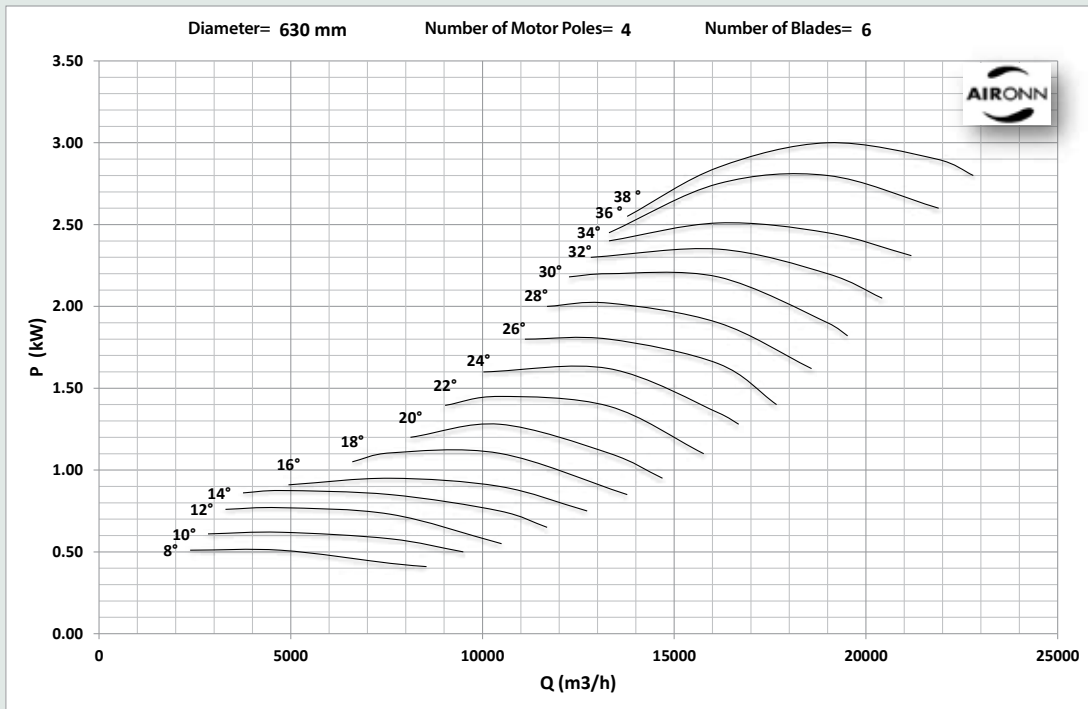
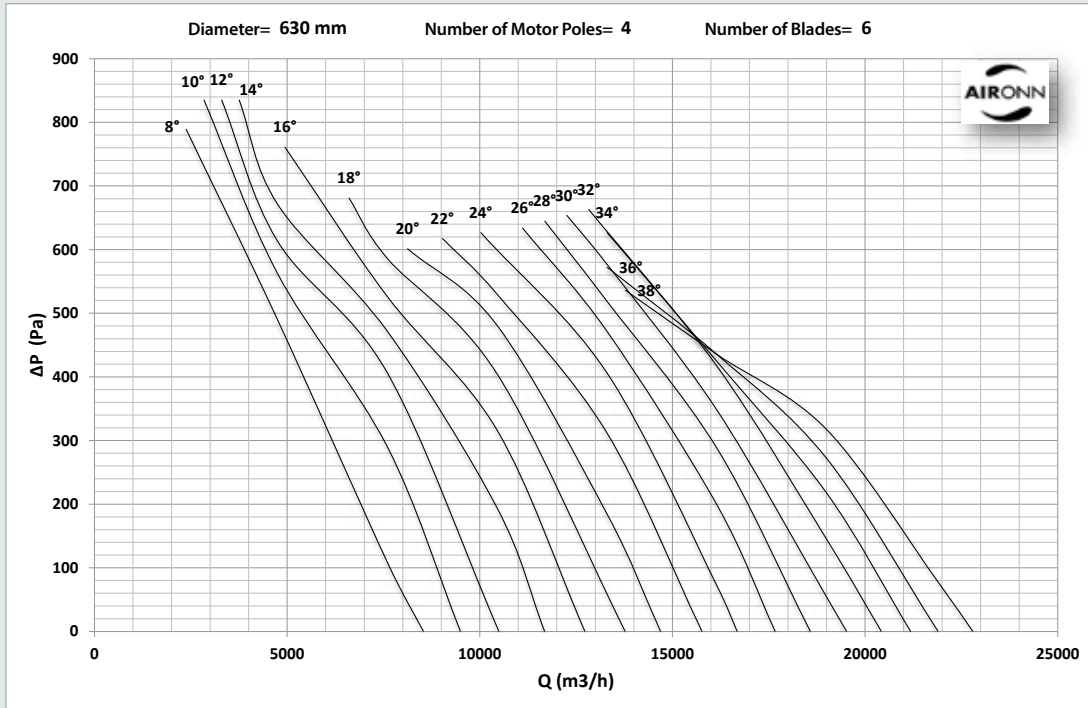

## Series Type Axial Fresh Air Fan Series

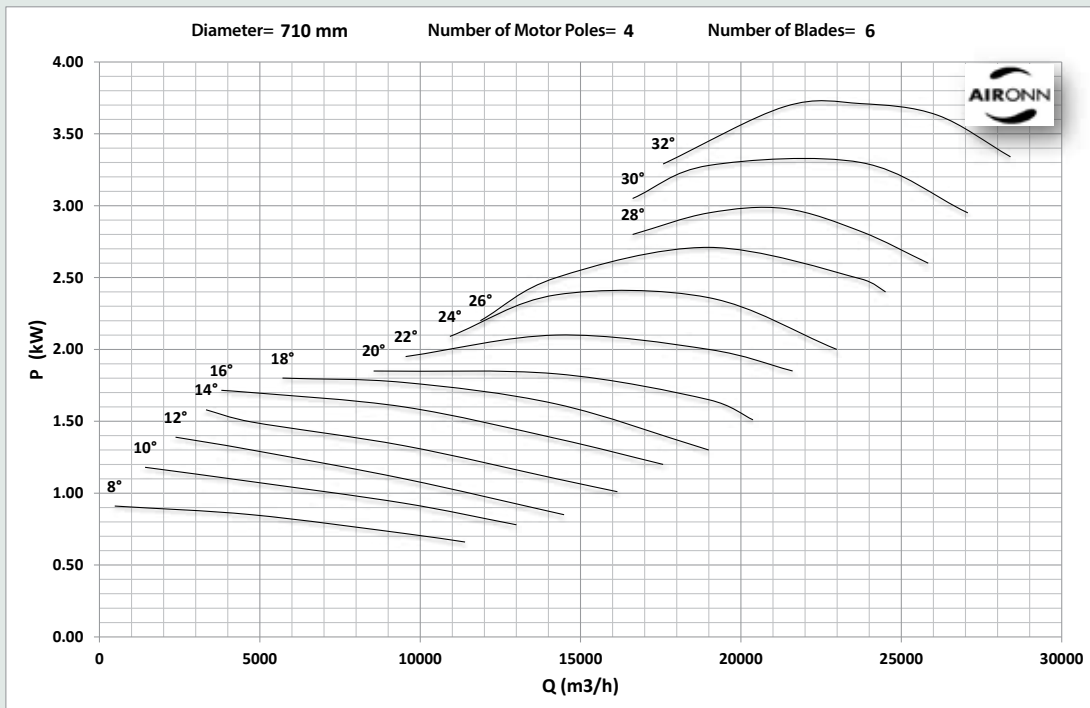
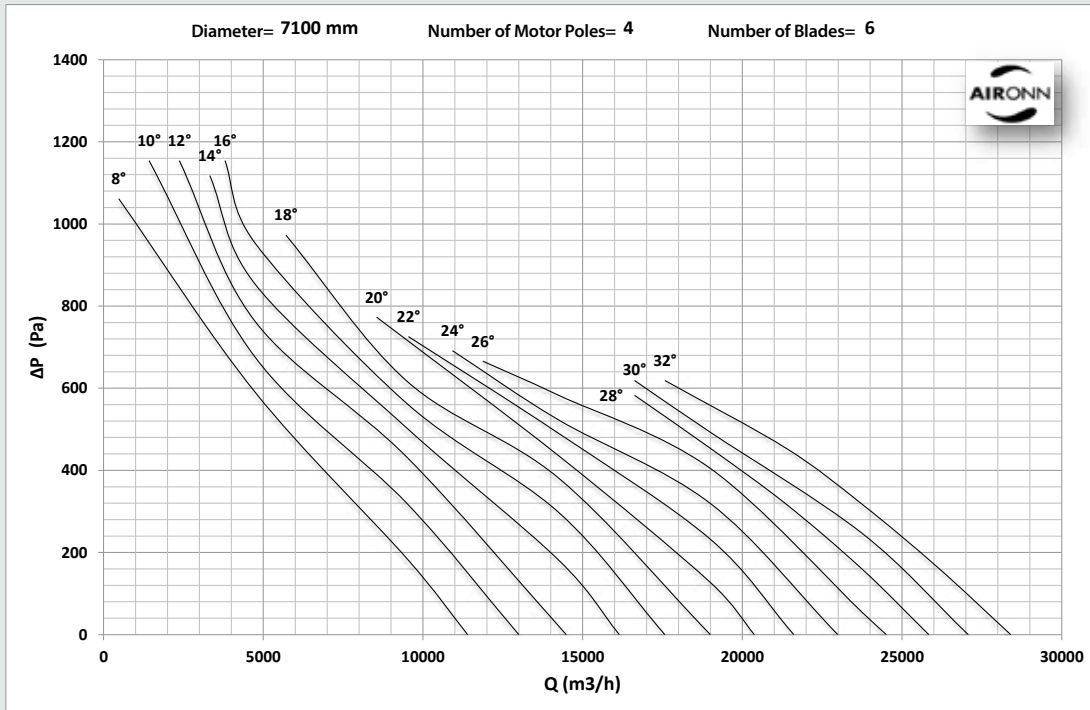

## Series Type Axial Fresh Air Fan Series

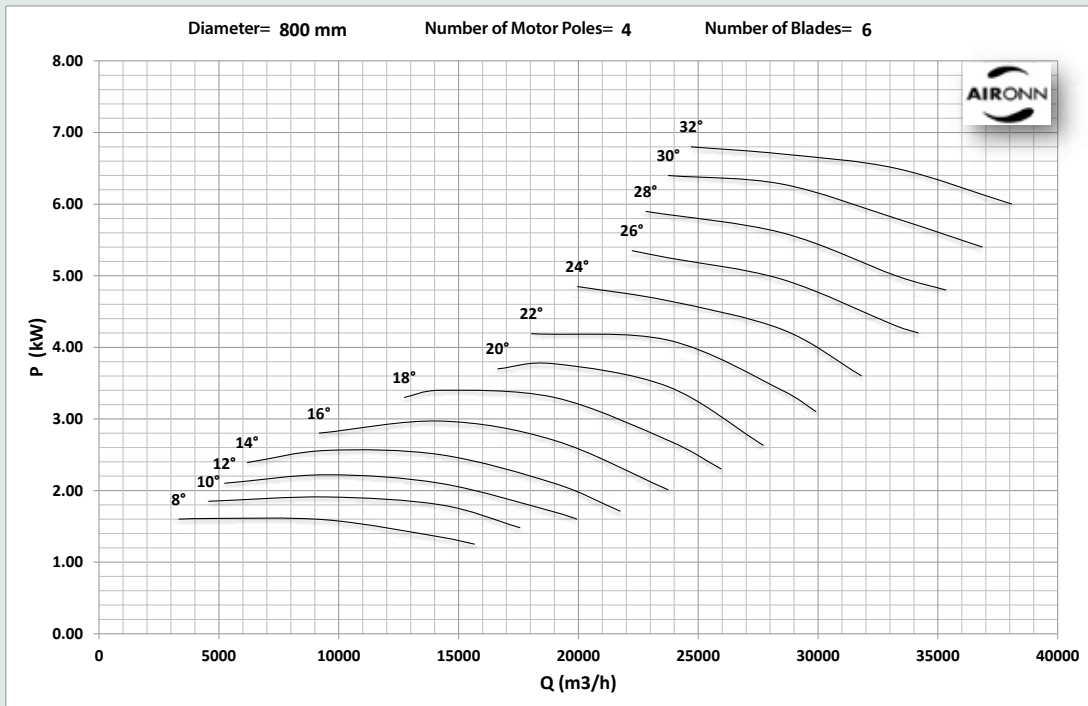
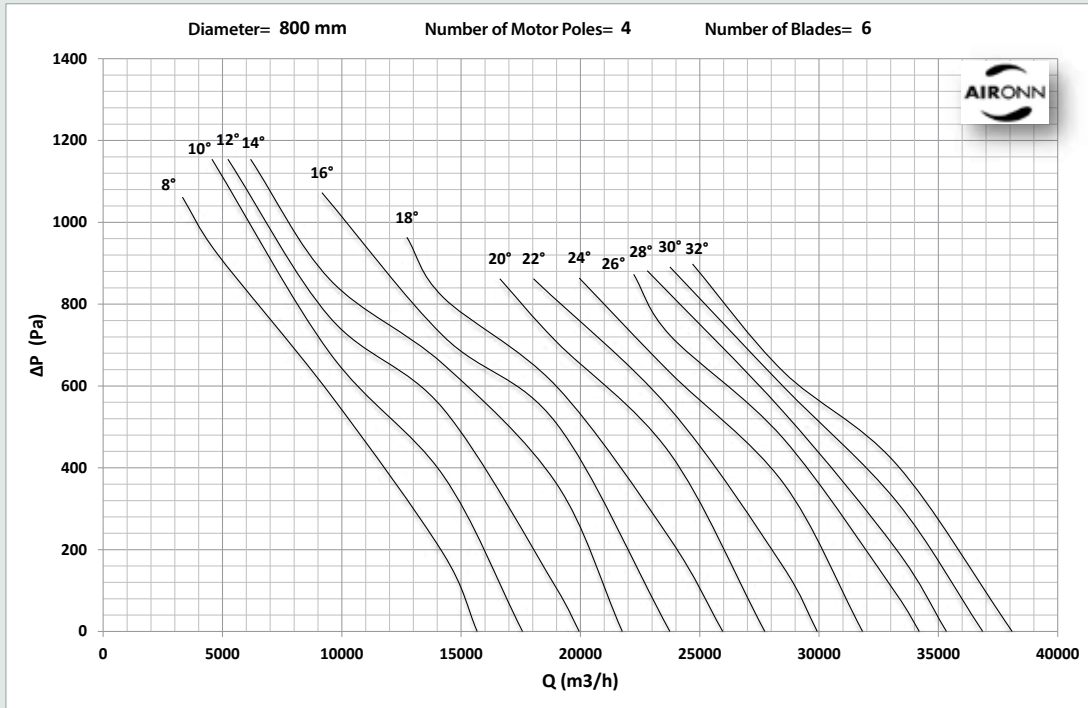

## Series Type Axial Fresh Air Fan Series

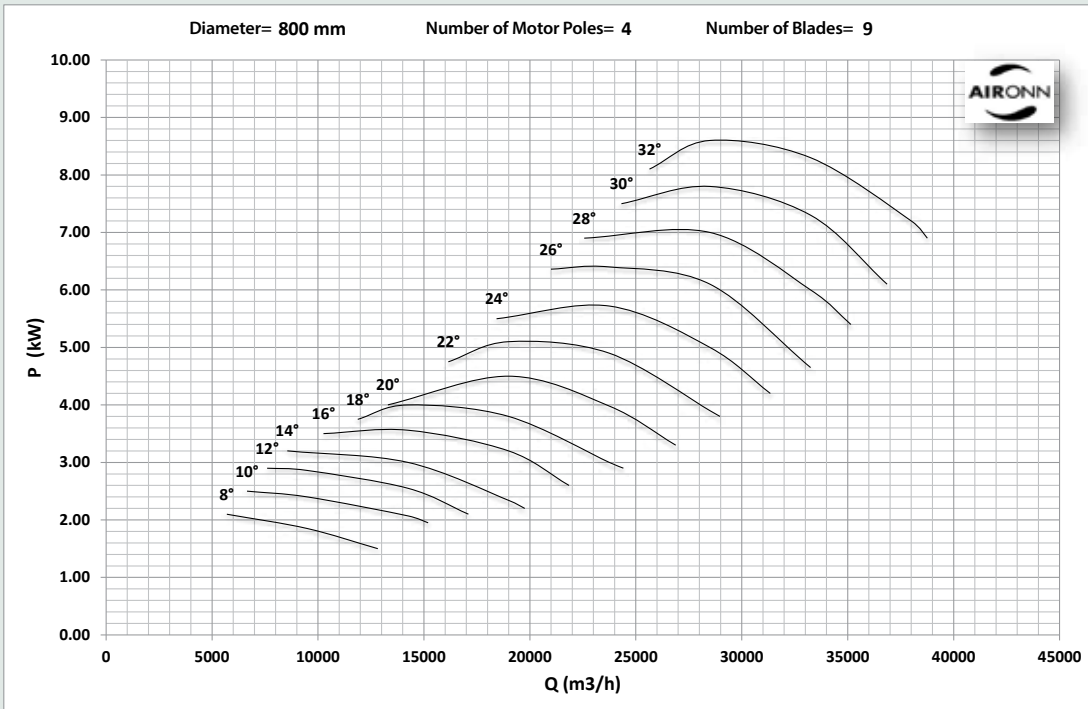
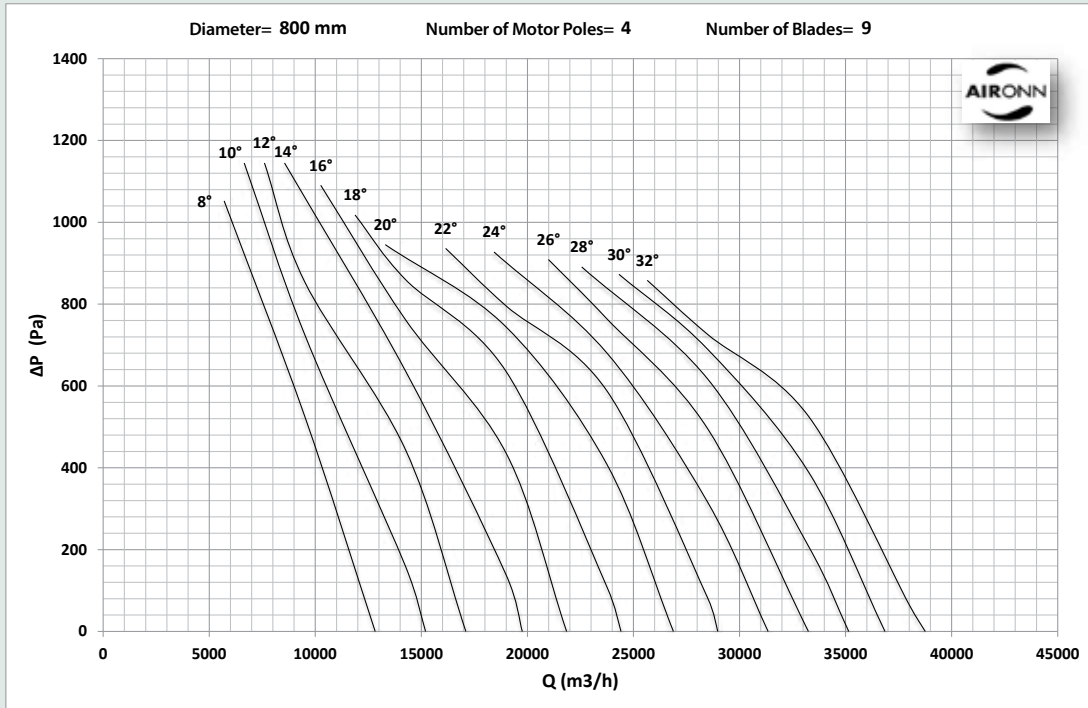

## Series Type Axial Fresh Air Fan Series

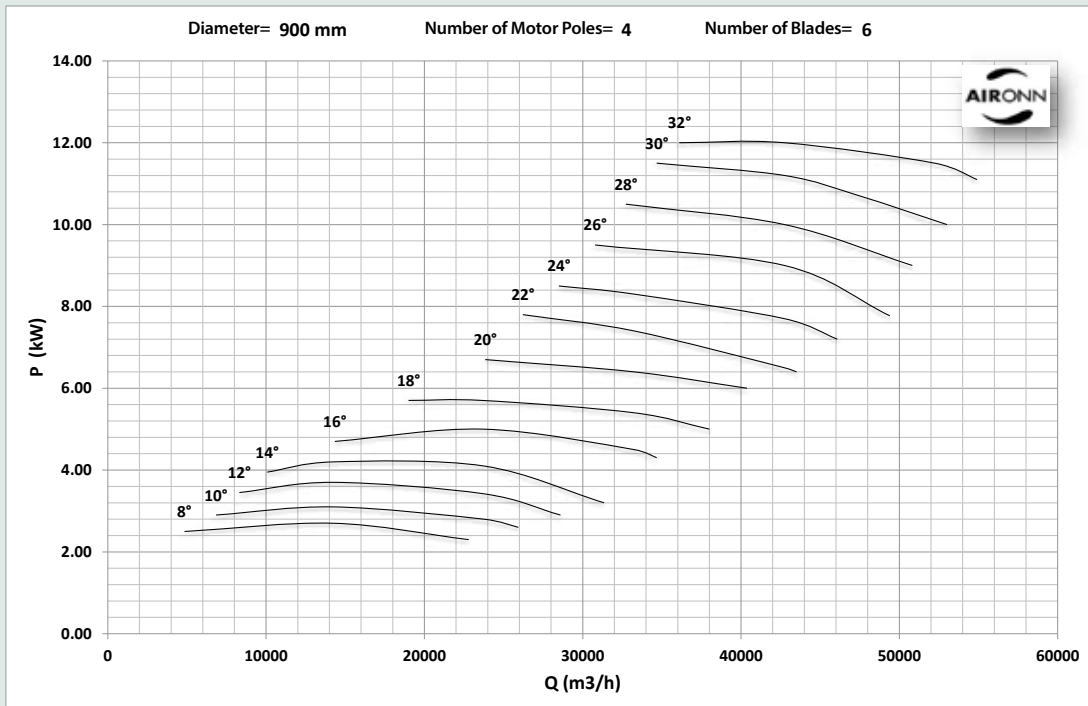
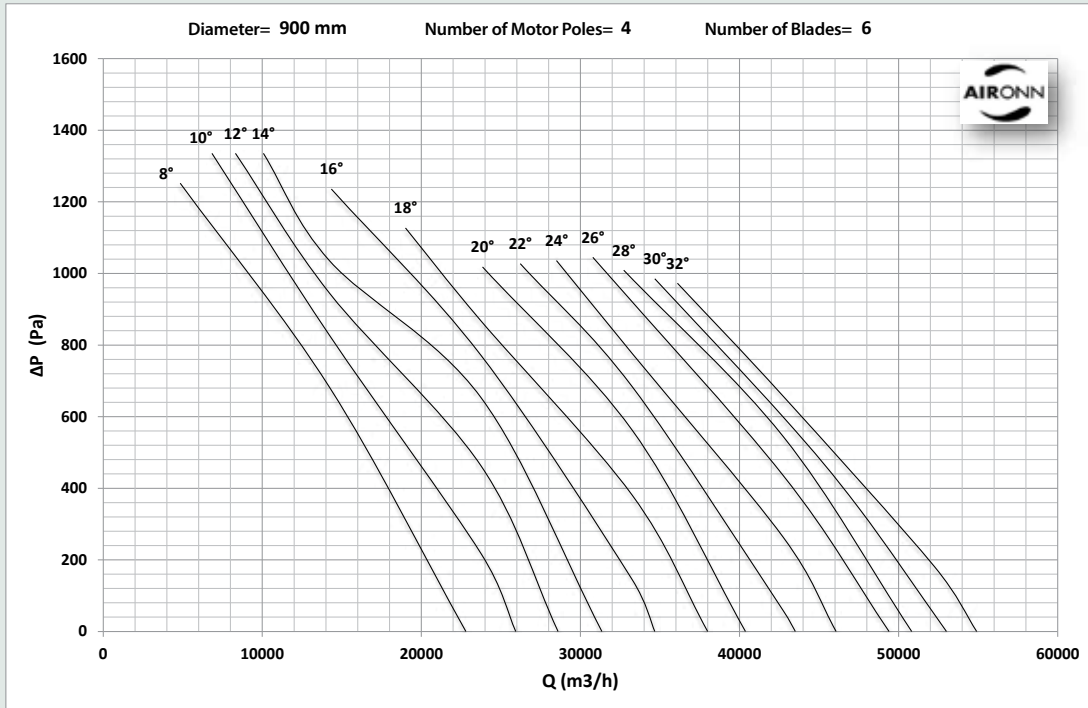

## Series Type Axial Fresh Air Fan Series

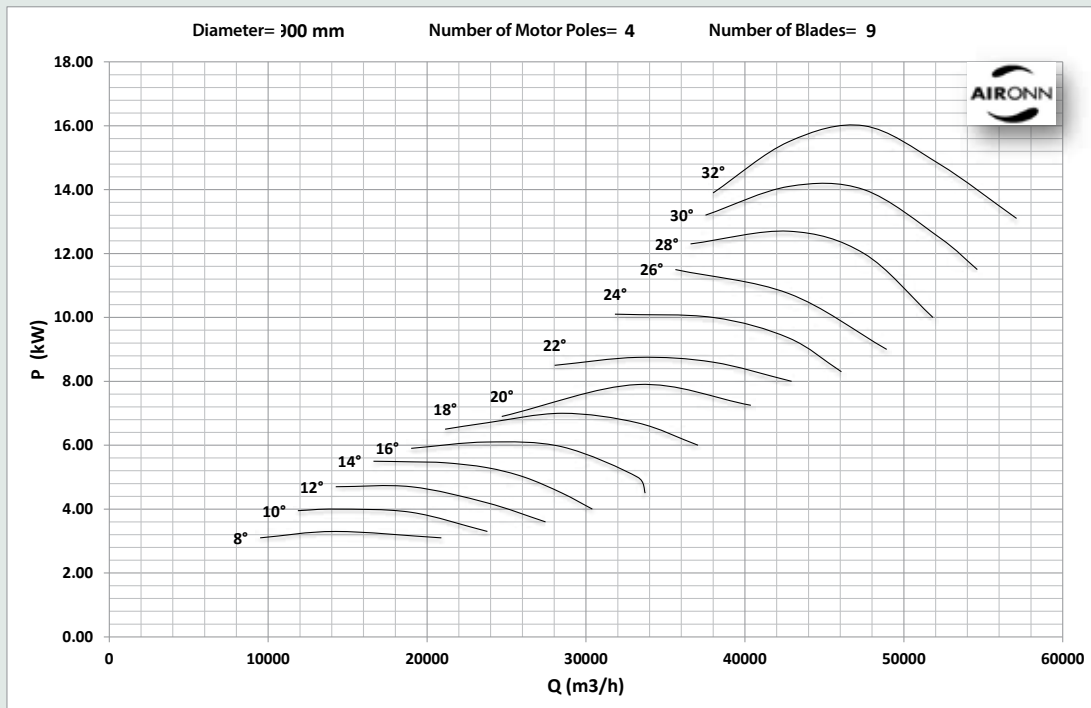
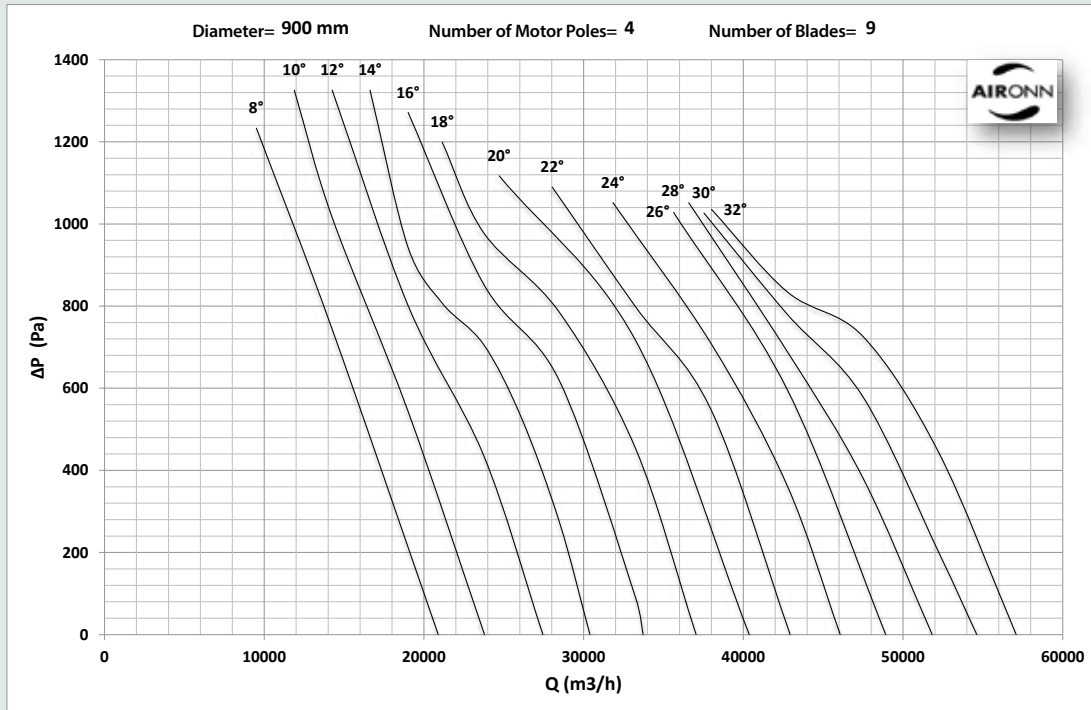

## Series Type Axial Fresh Air Fan Series

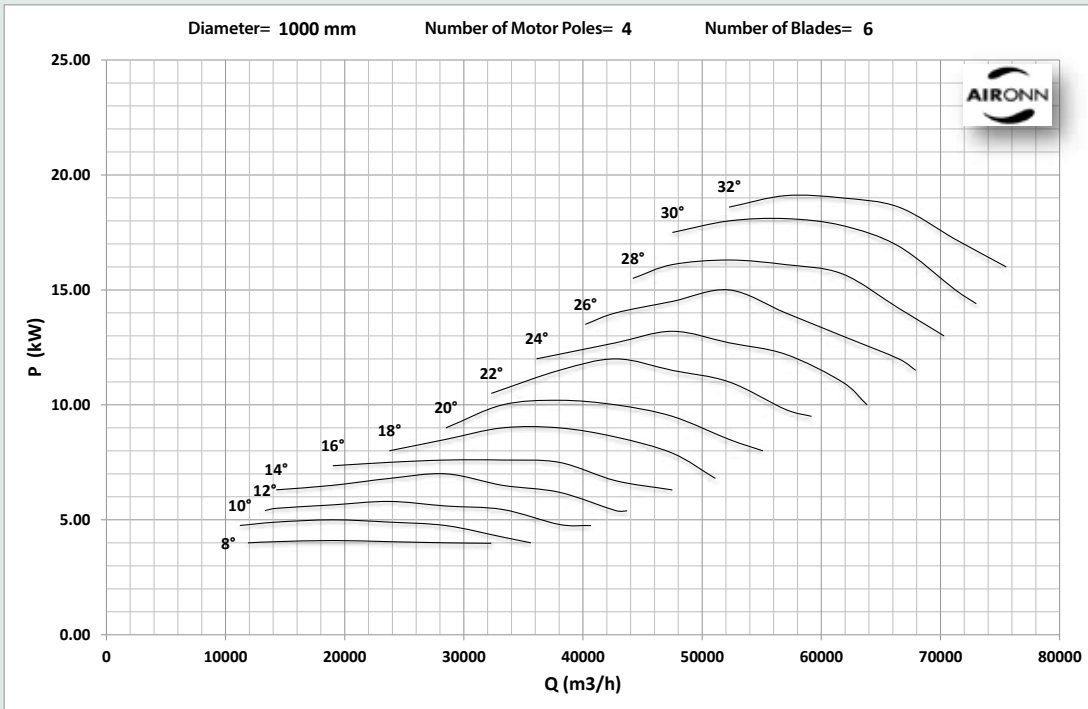
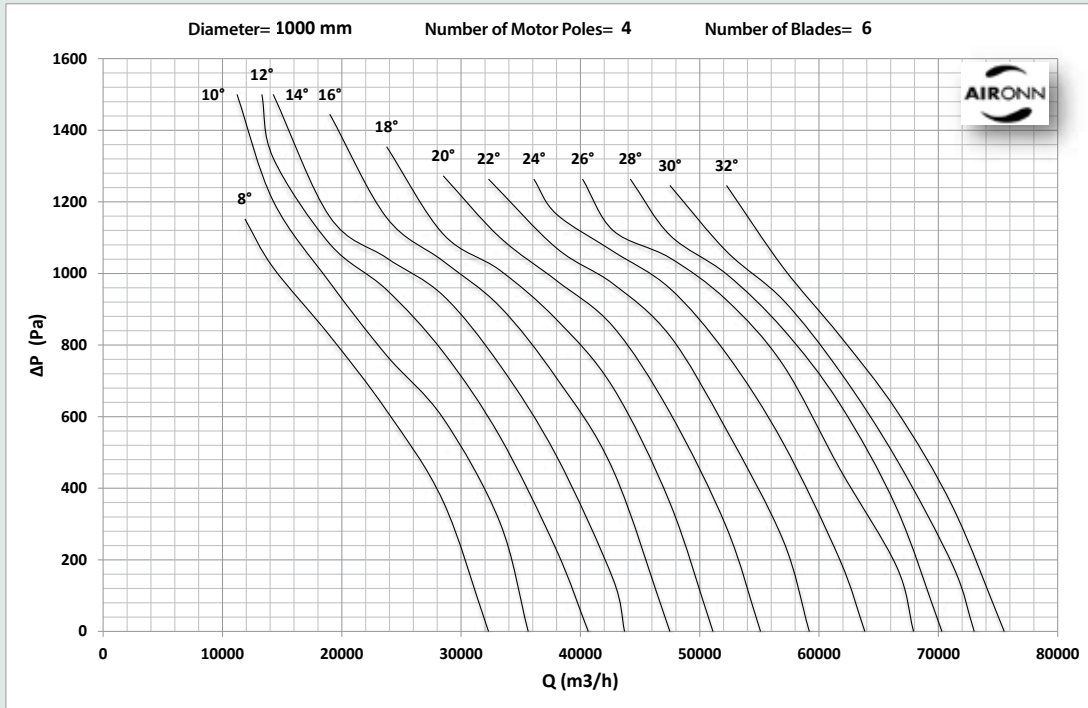



## Series Type Axial Fresh Air Fan Series

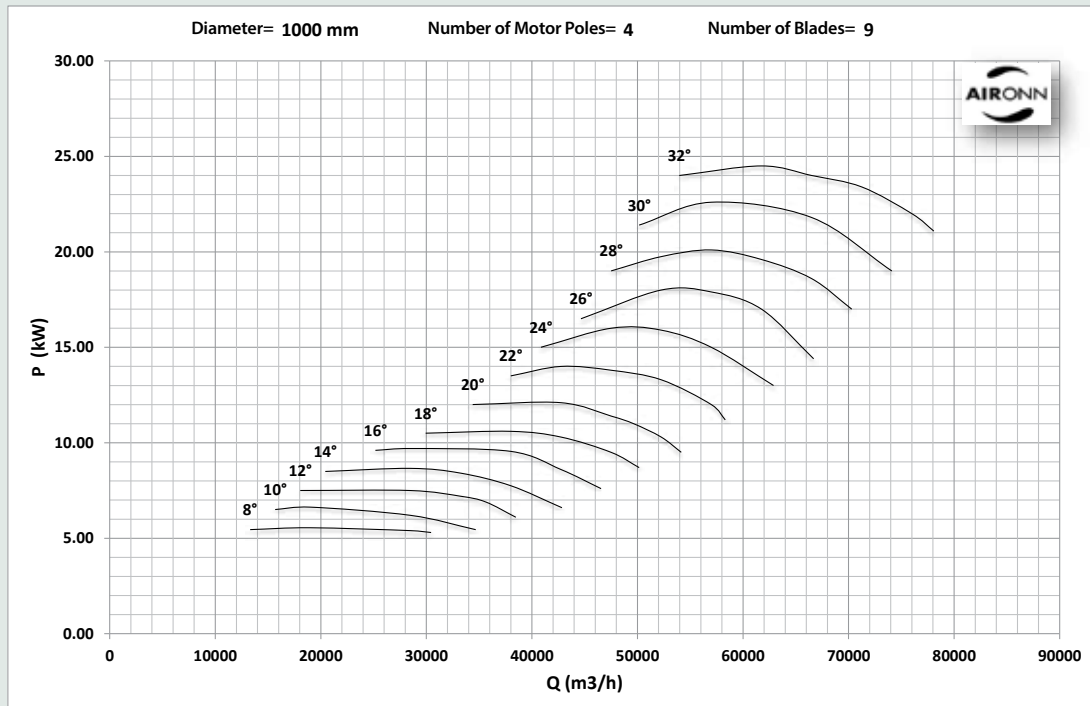
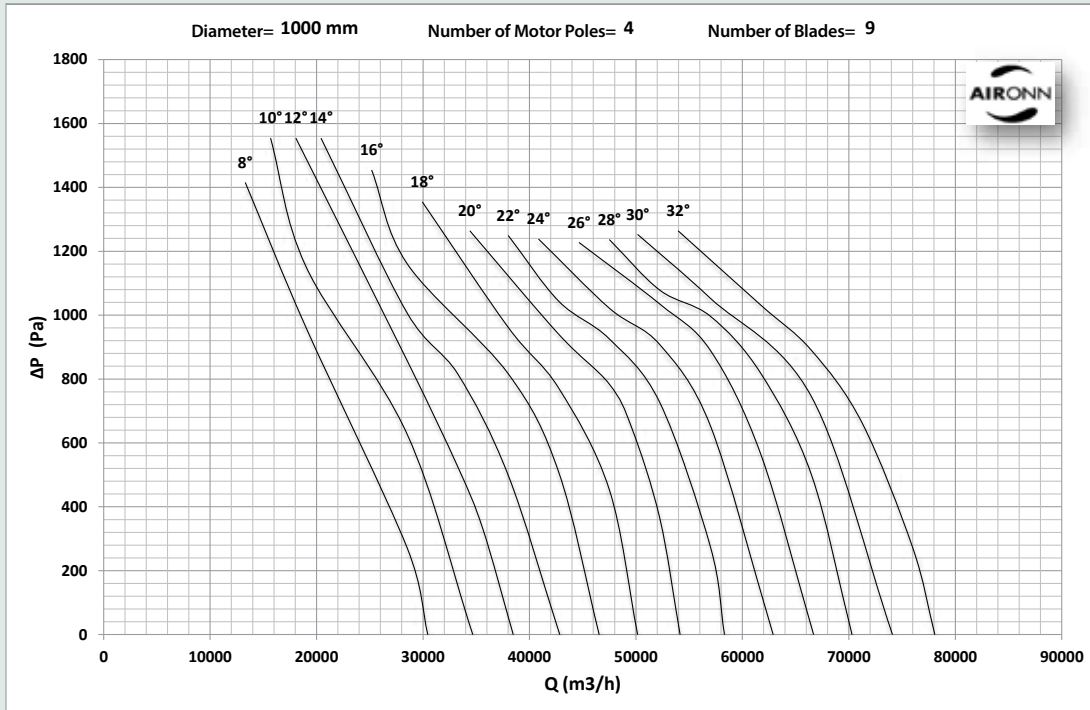

## Series Type Axial Fresh Air Fan Series

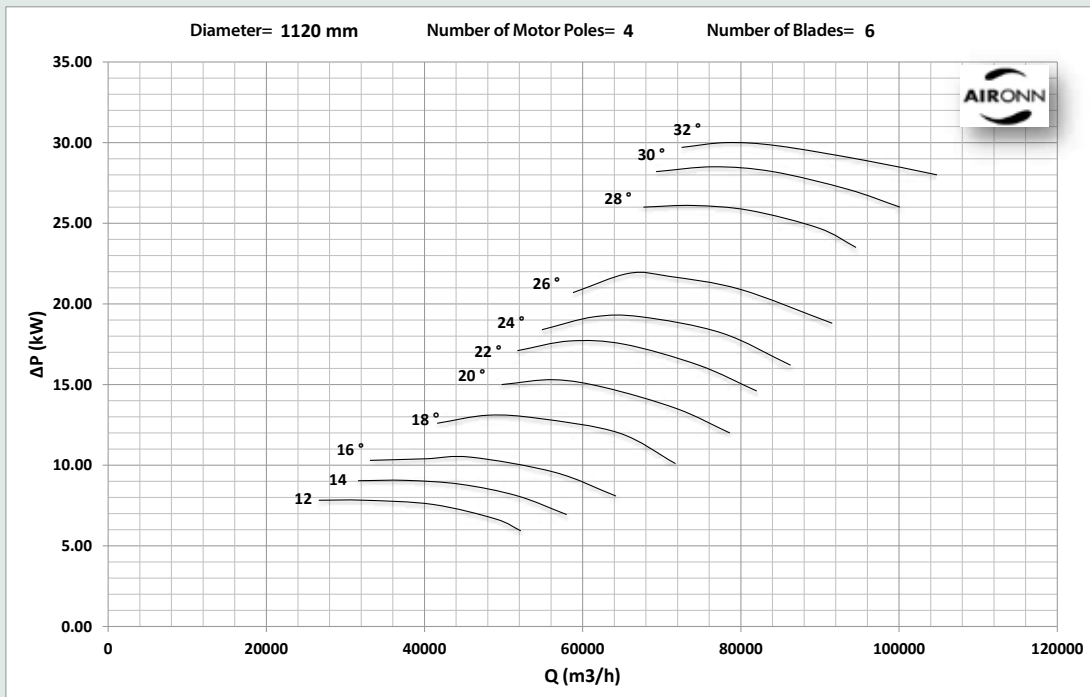
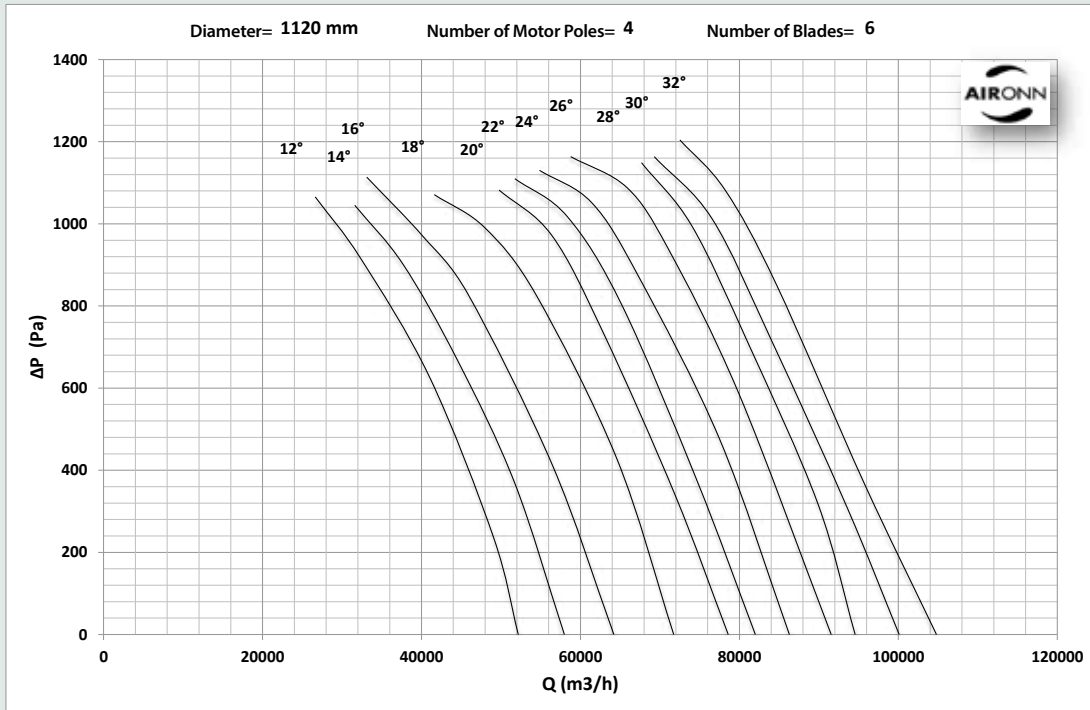

## Series Type Axial Fresh Air Fan Series

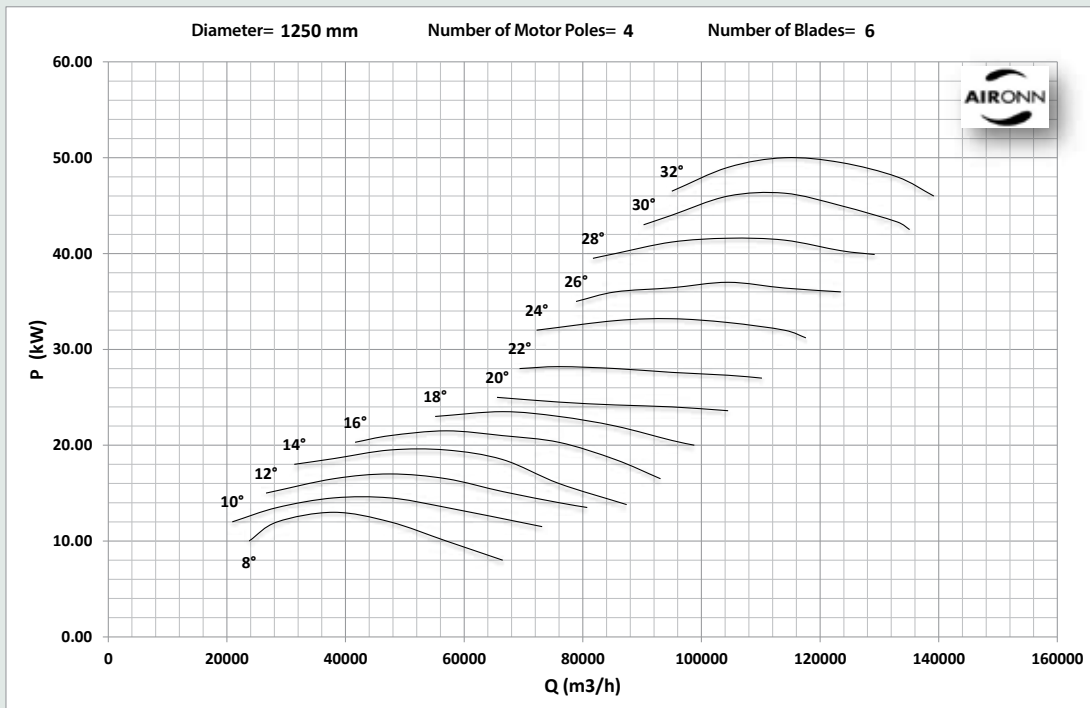
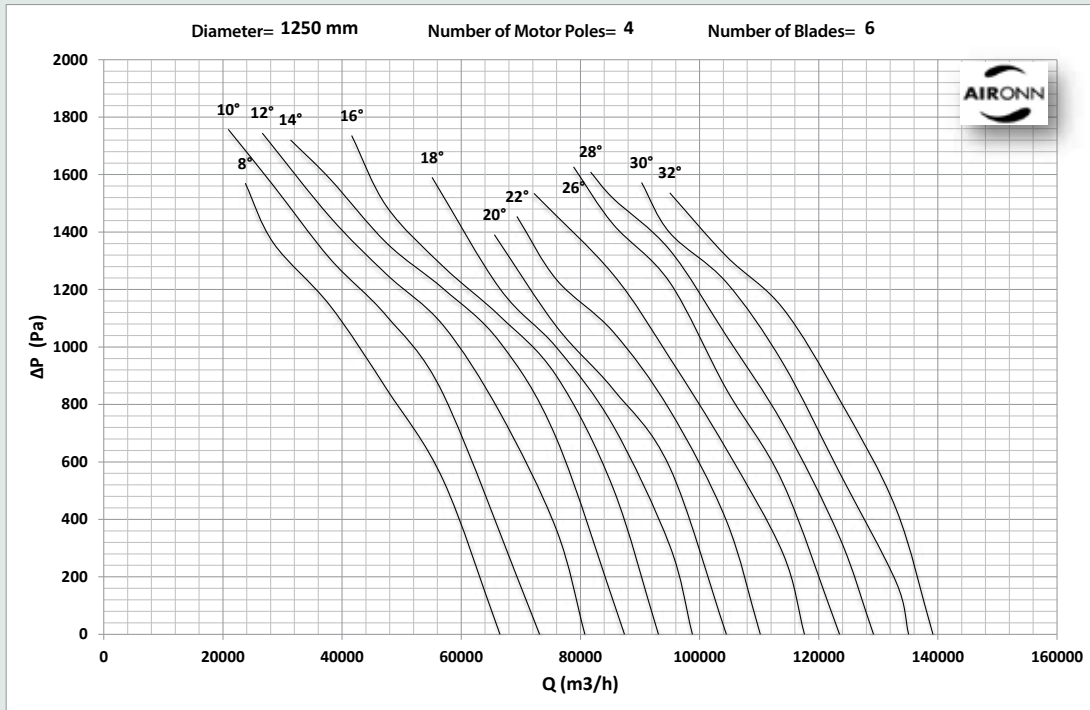

## Series Type Axial Fresh Air Fan Series

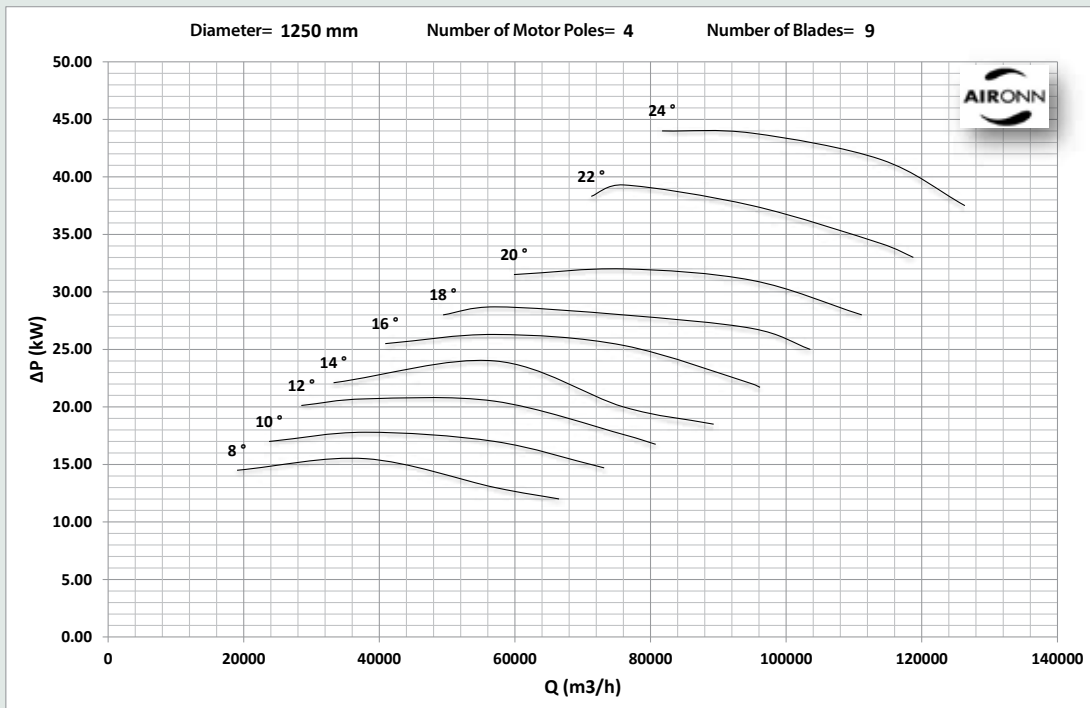
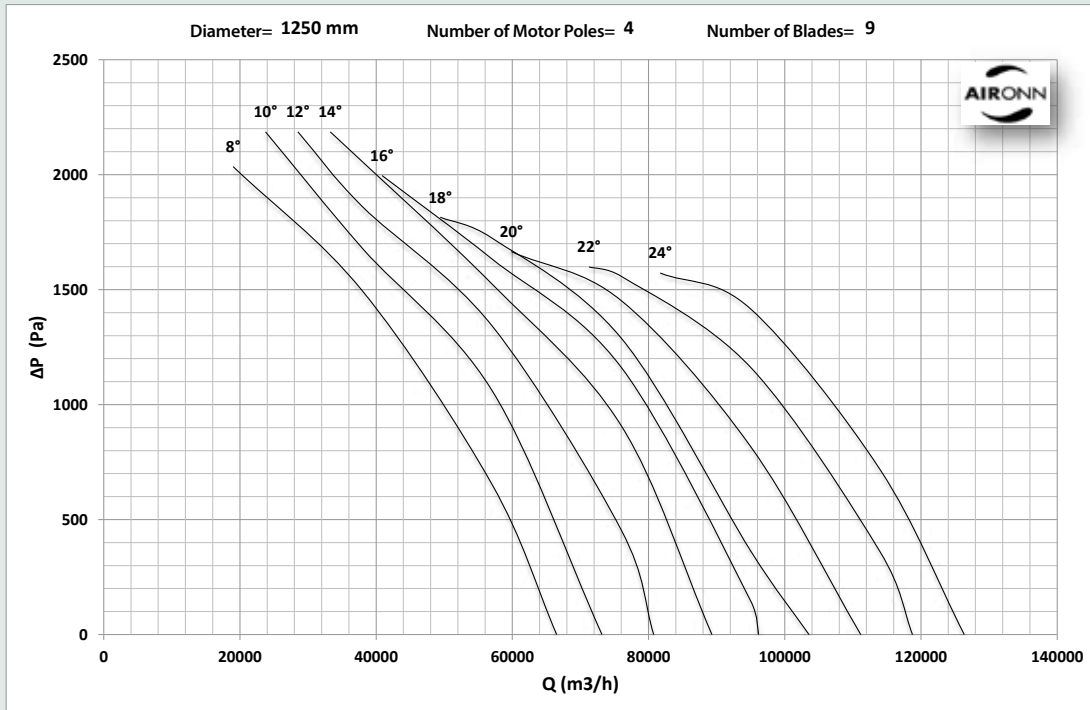

# Series Type Axial Smoke Exhaust Fan Series

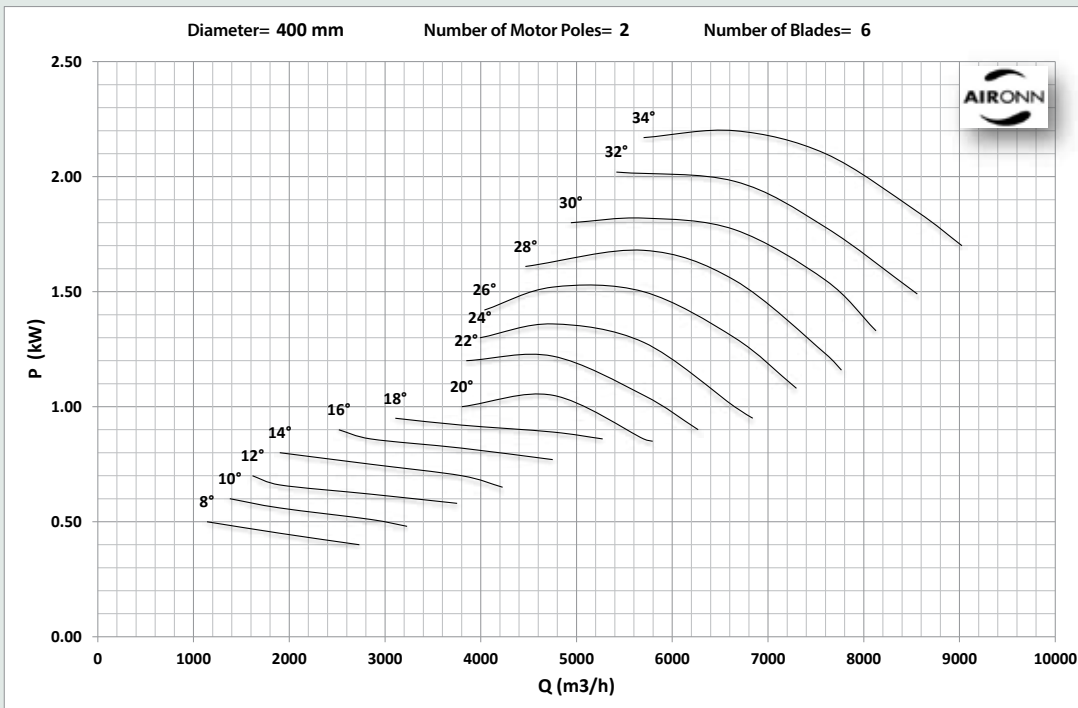
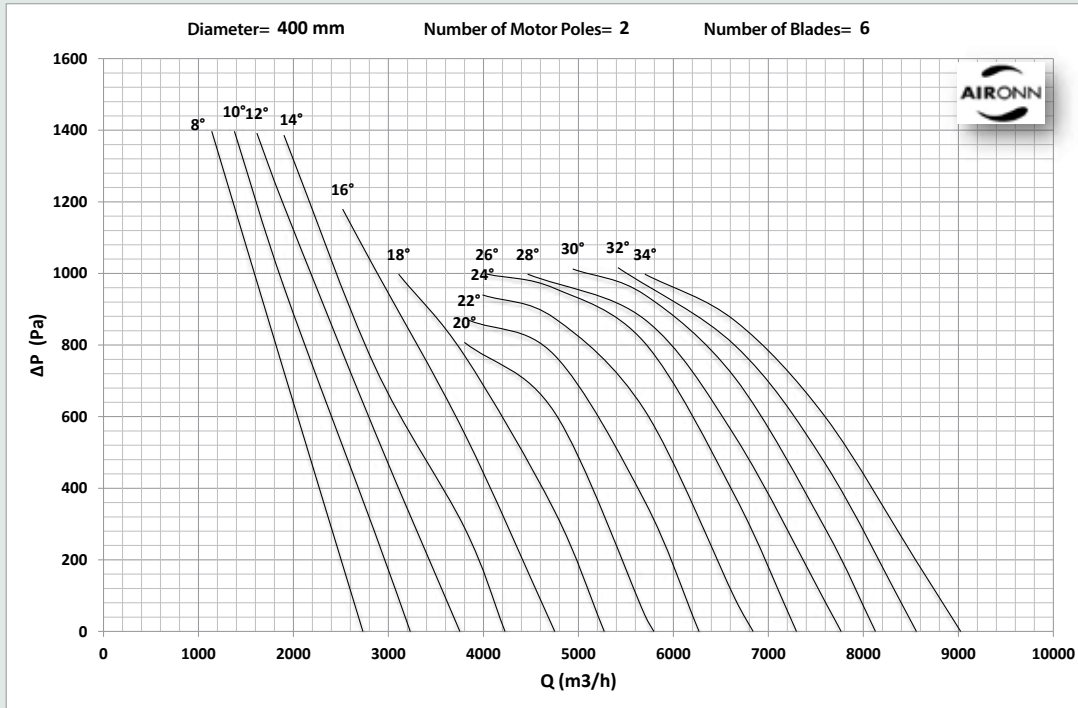

# Series Type Axial Smoke Exhaust Fan Series

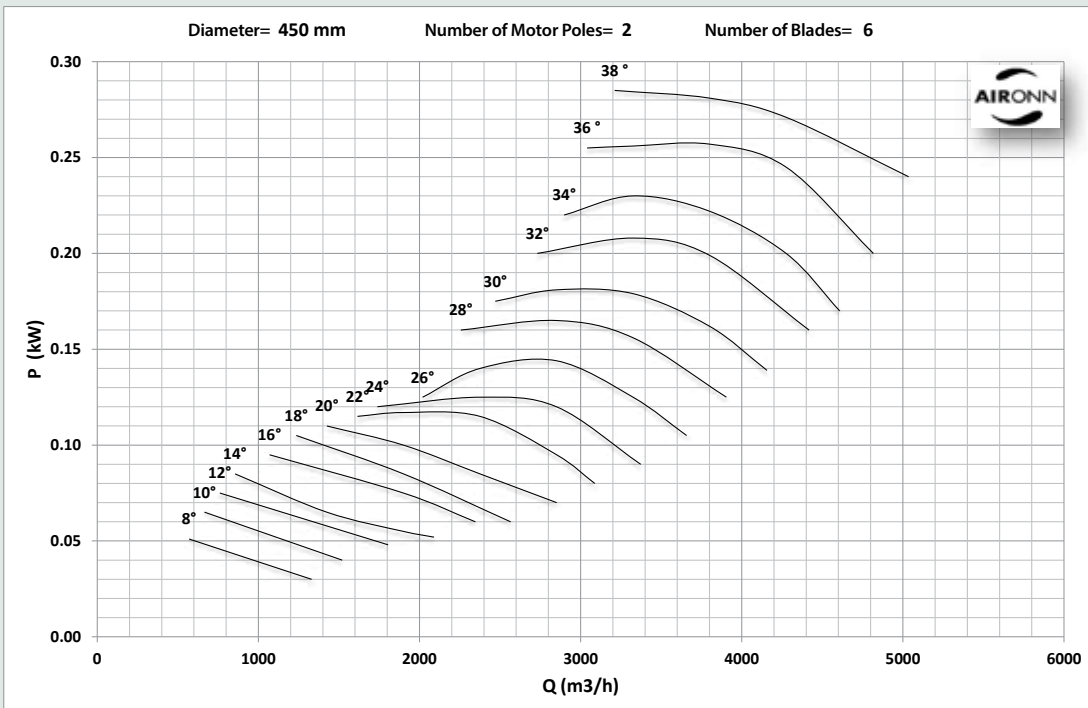
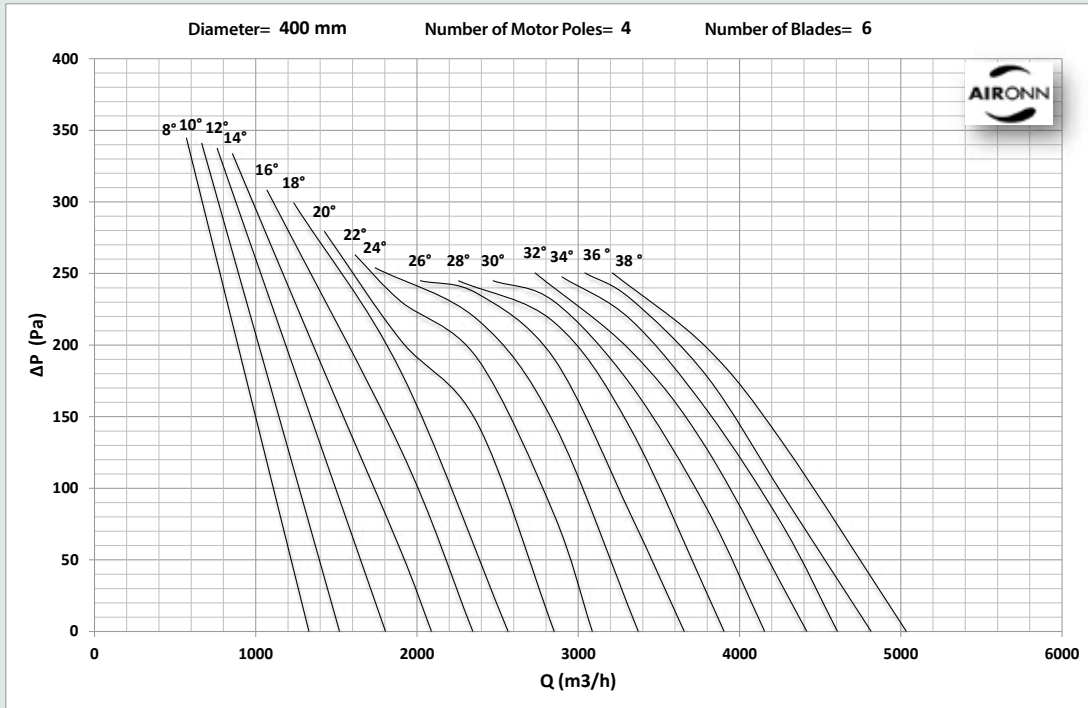

# Series Type Axial Smoke Exhaust Fan Series

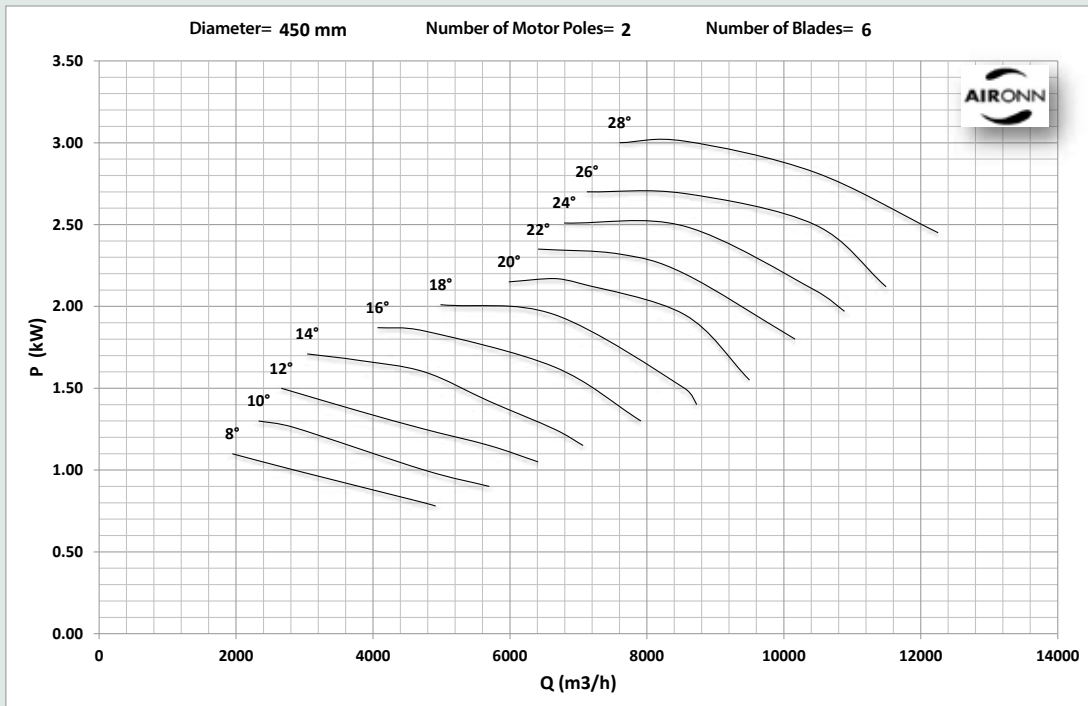
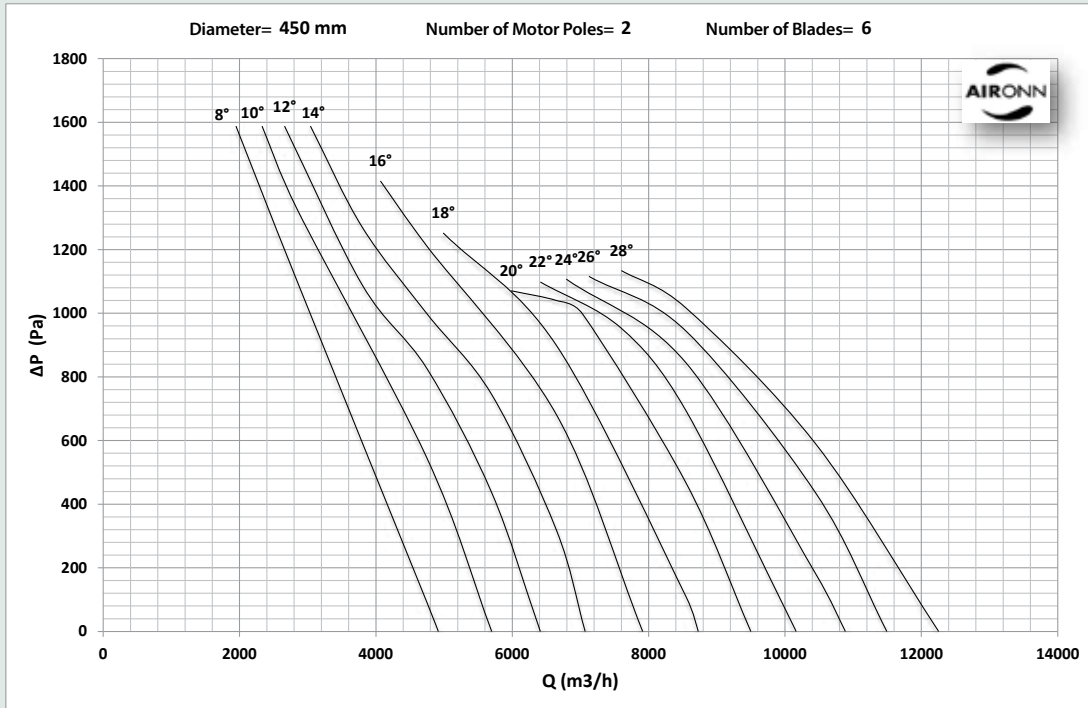

# Series Type Axial Smoke Exhaust Fan Series

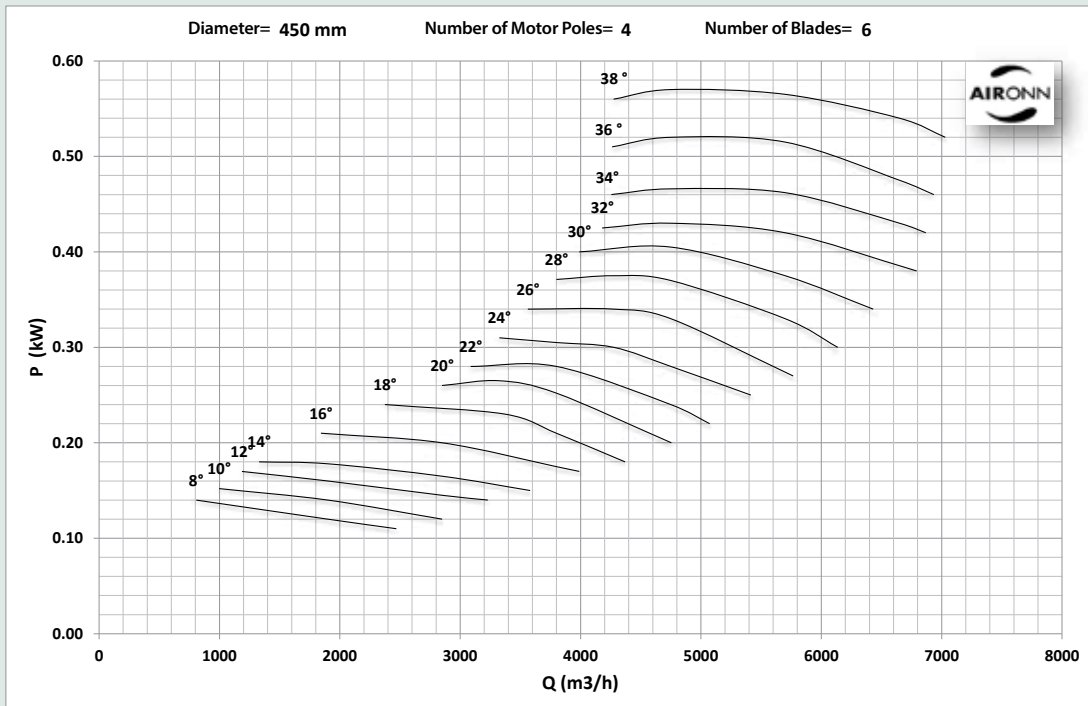
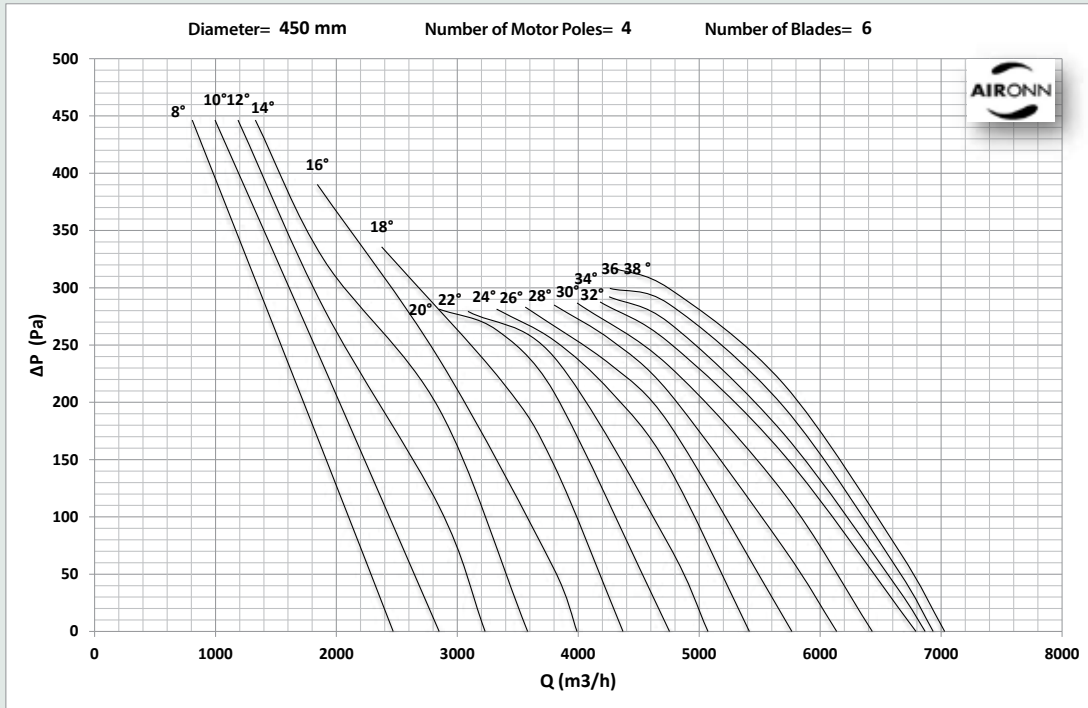



# Series Type Axial Smoke Exhaust Fan Series

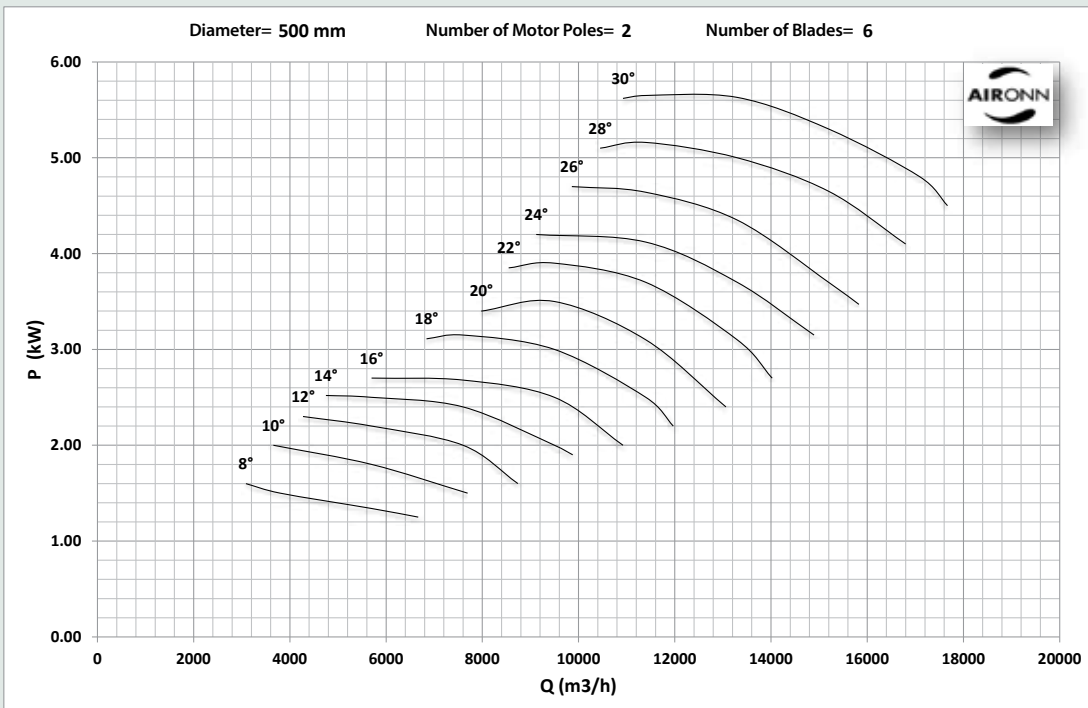
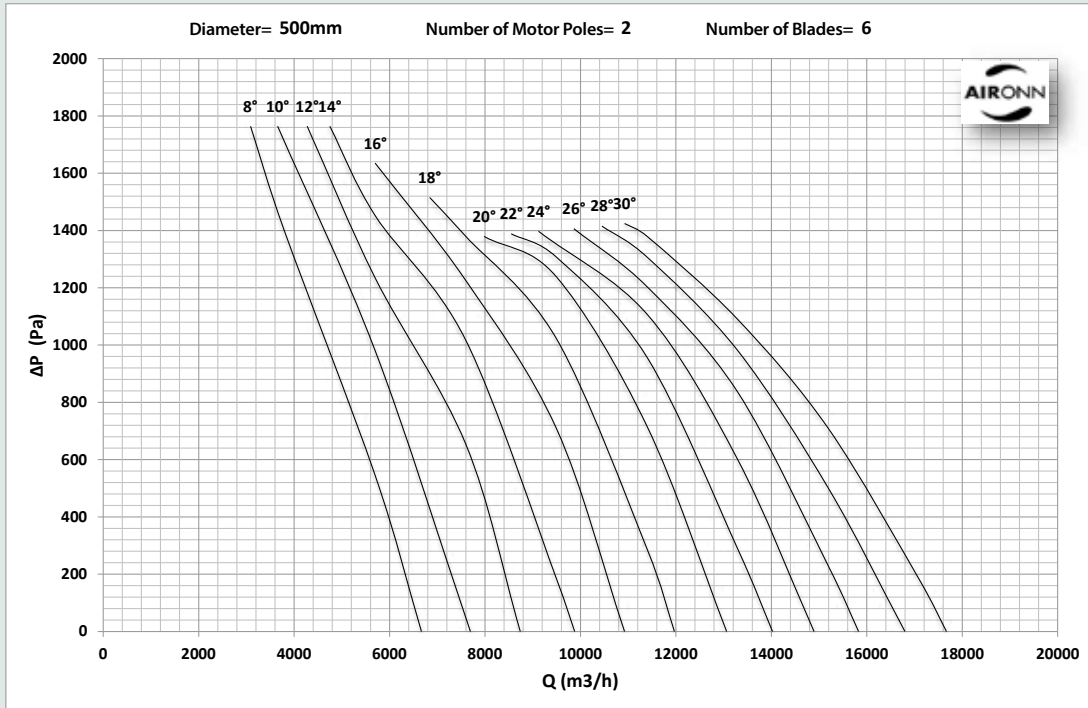

# Series Type Axial Smoke Exhaust Fan Series

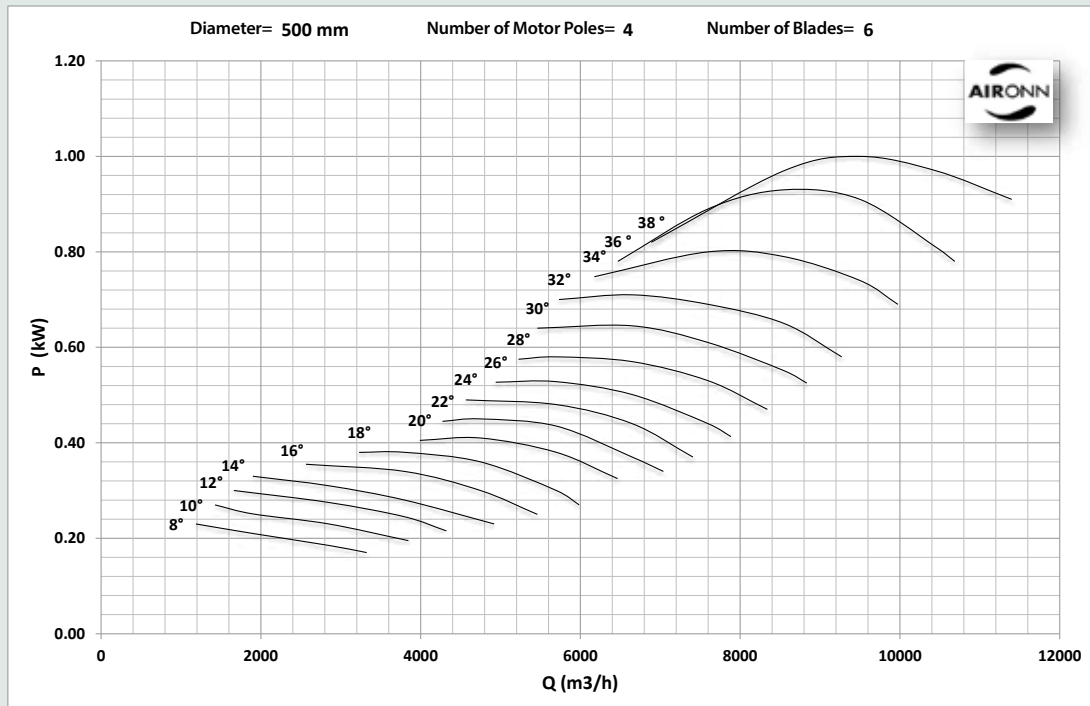
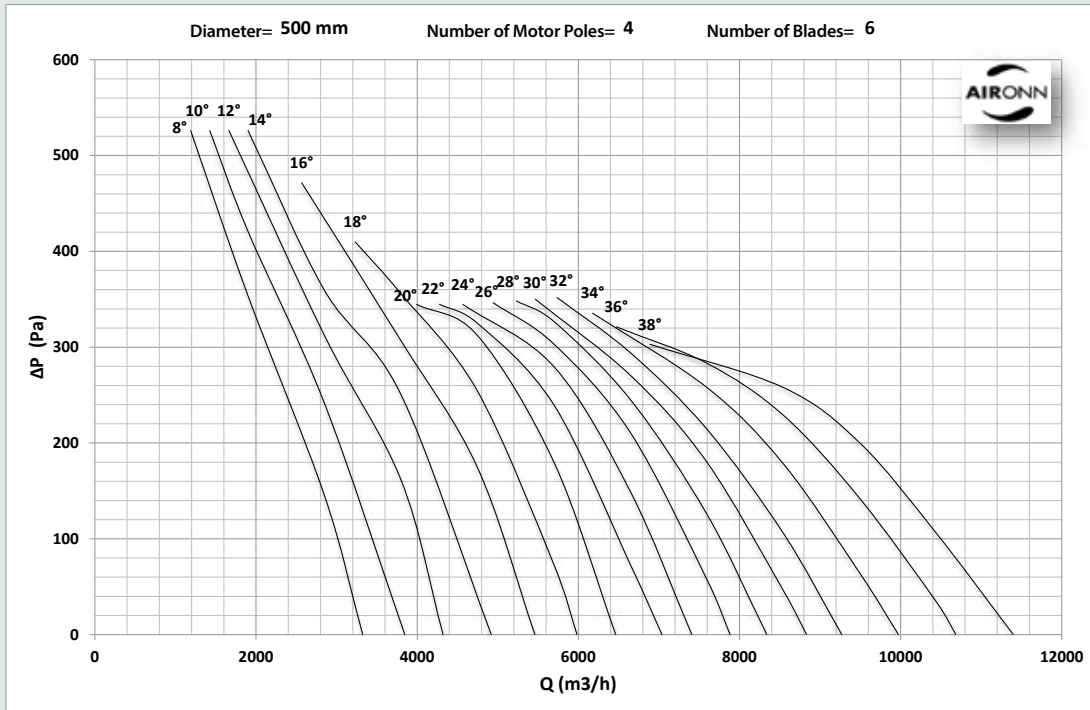

# Series Type Axial Smoke Exhaust Fan Series

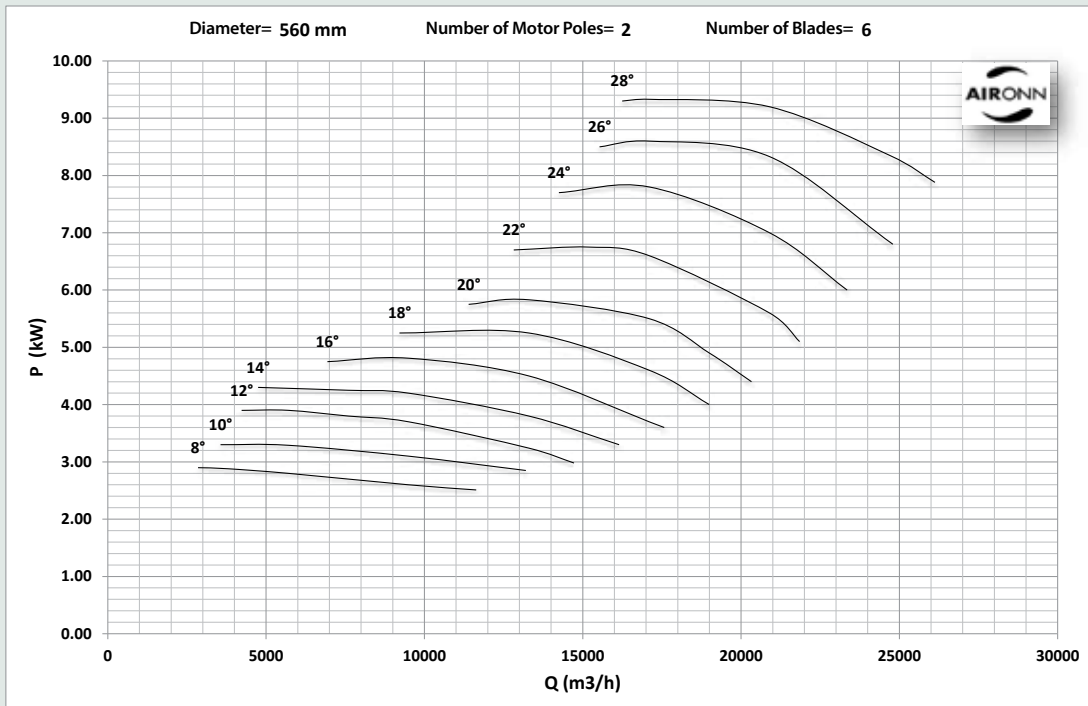
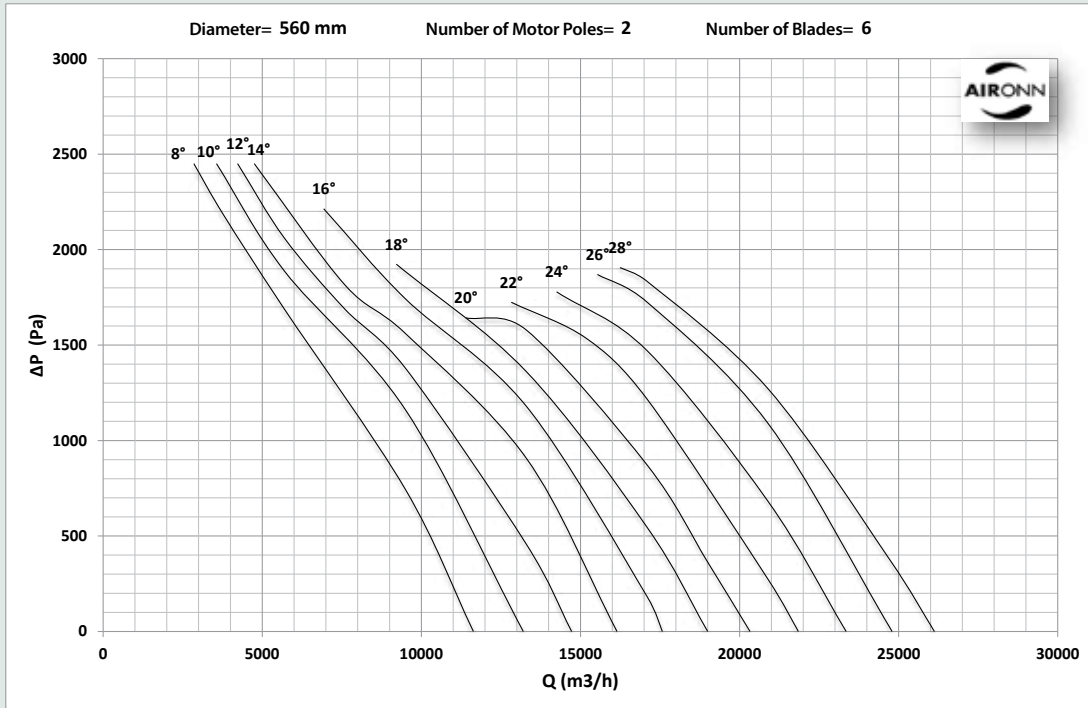

# Series Type Axial Smoke Exhaust Fan Series

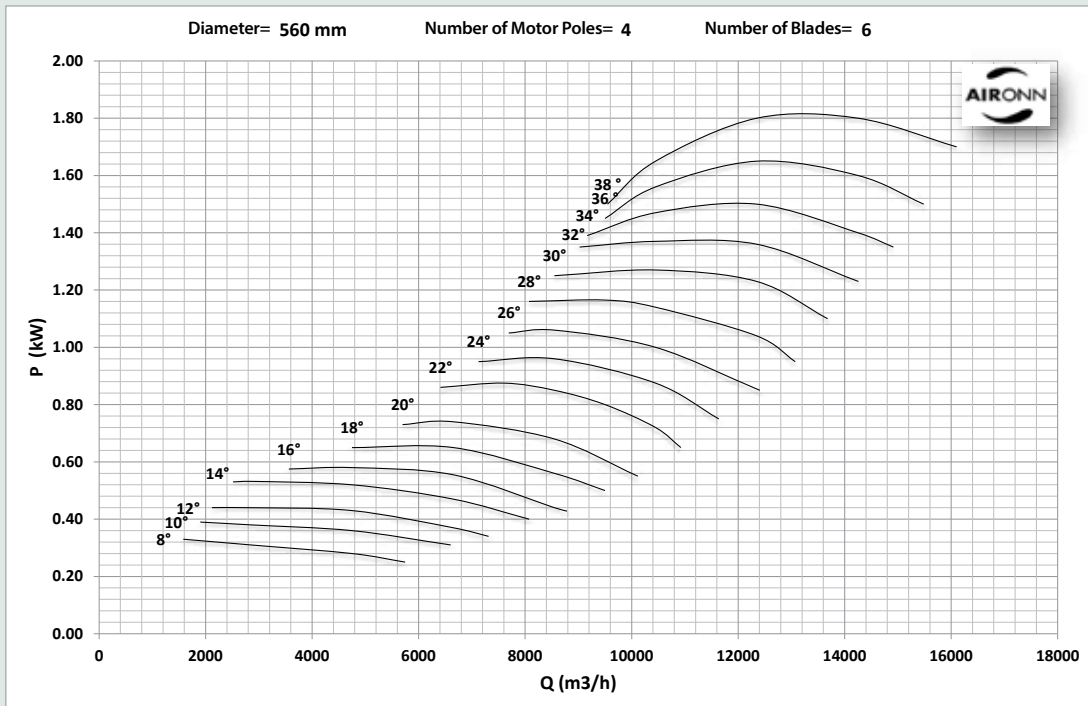
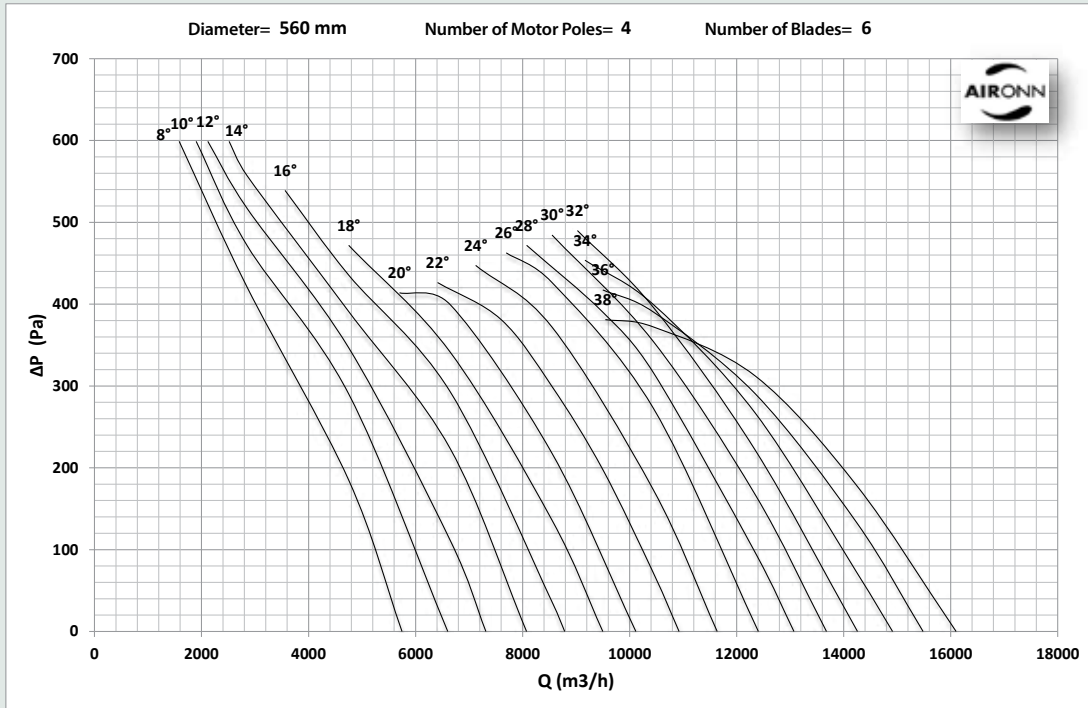

# Series Type Axial Smoke Exhaust Fan Series

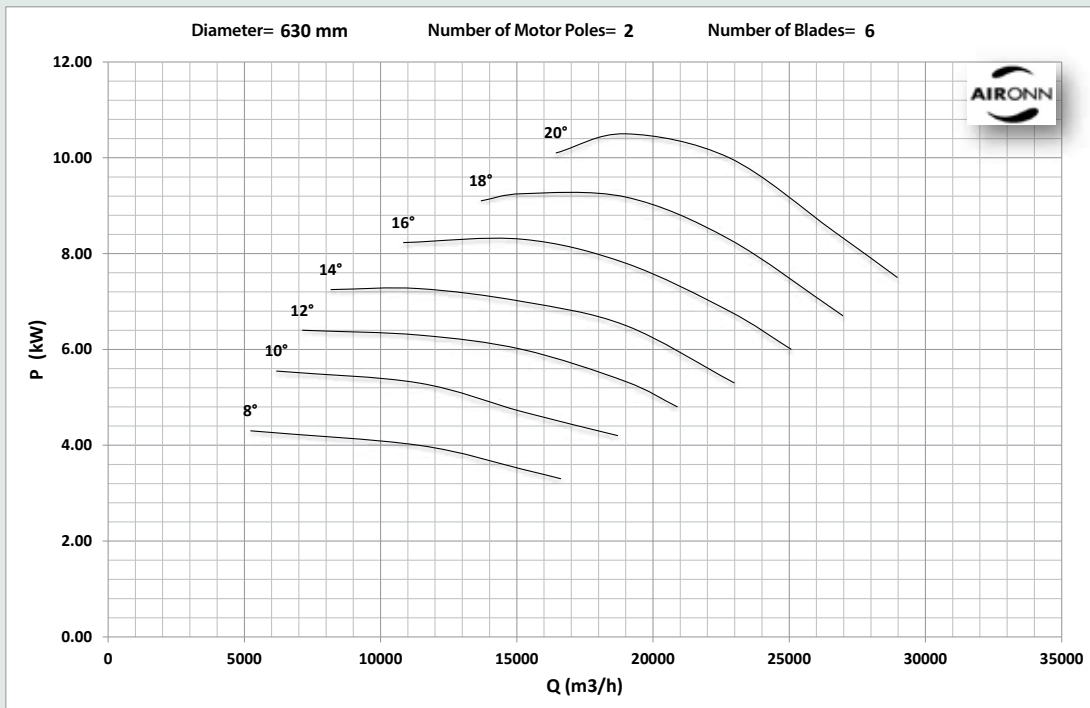
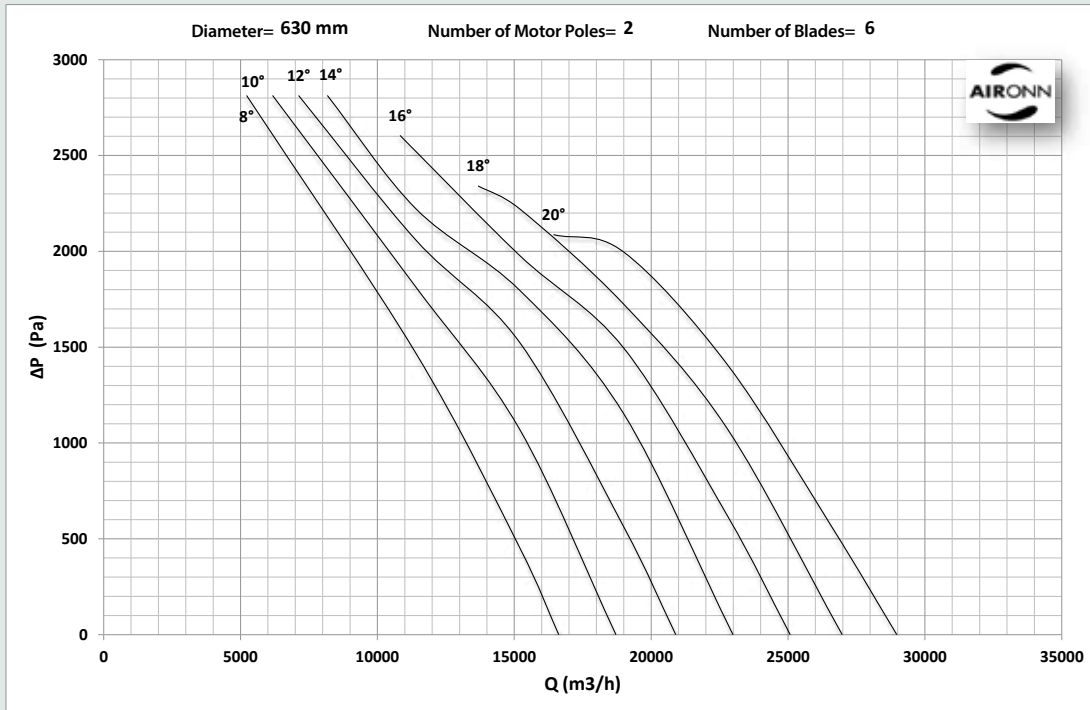

# Series Type Axial Smoke Exhaust Fan Series

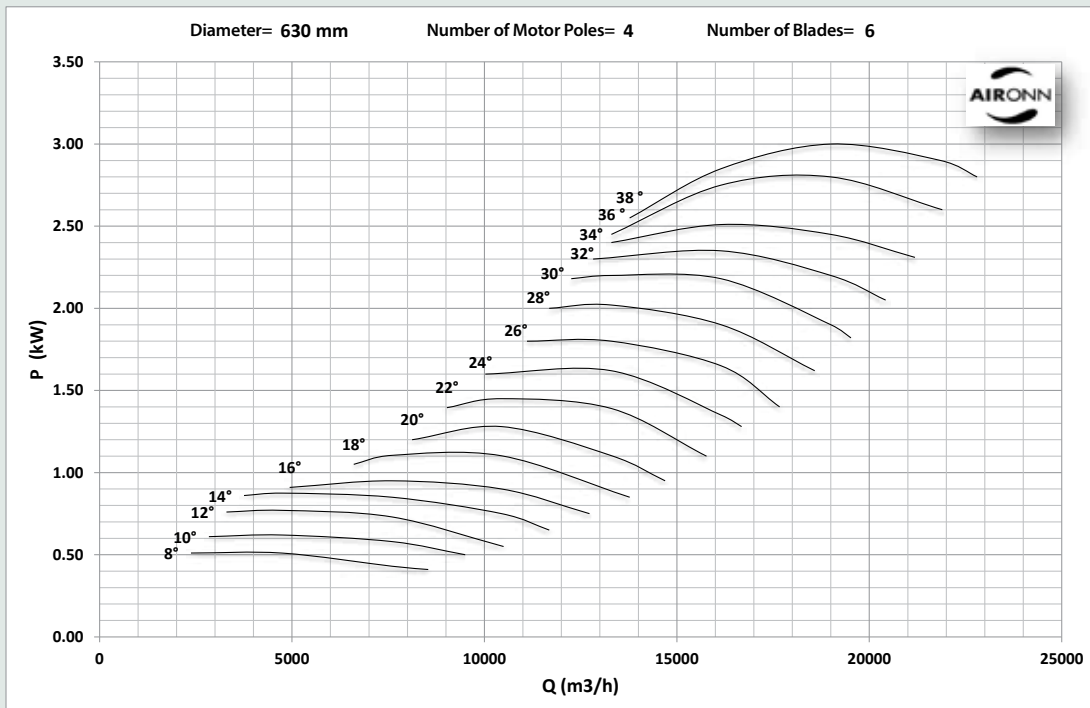
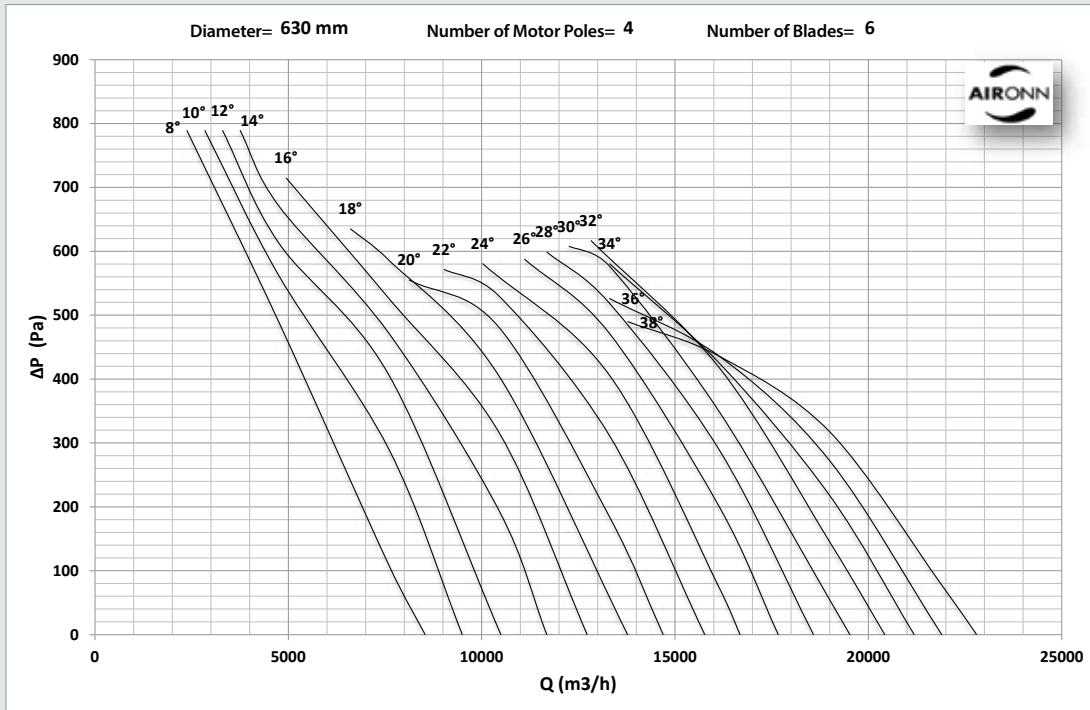

# Series Type Axial Smoke Exhaust Fan Series

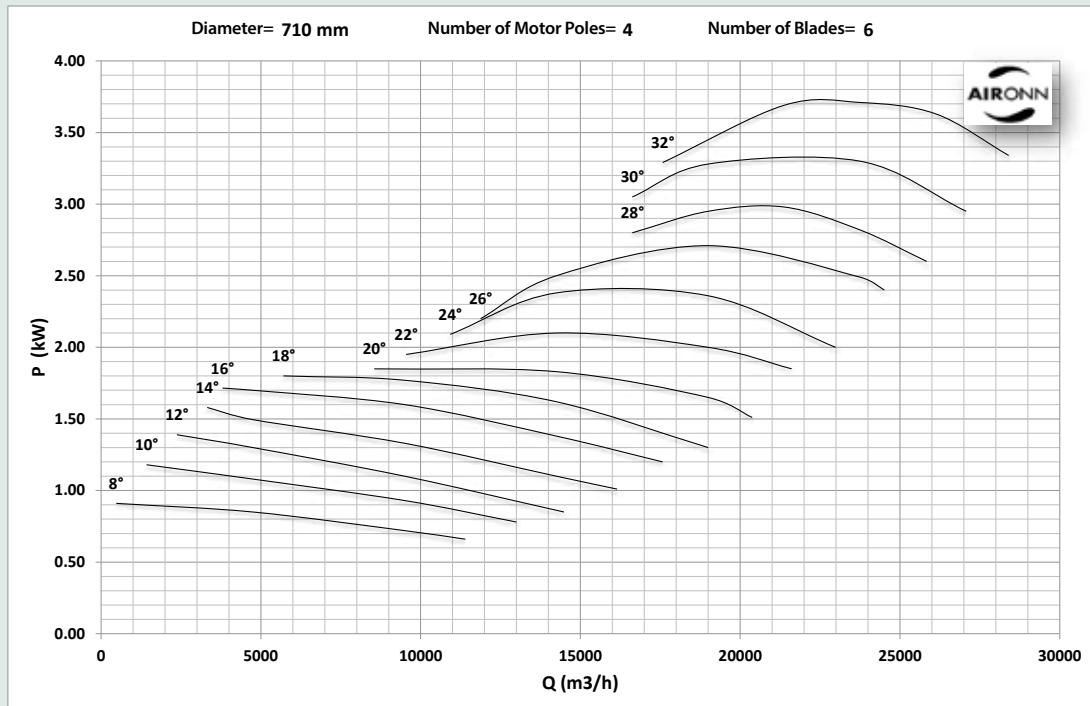
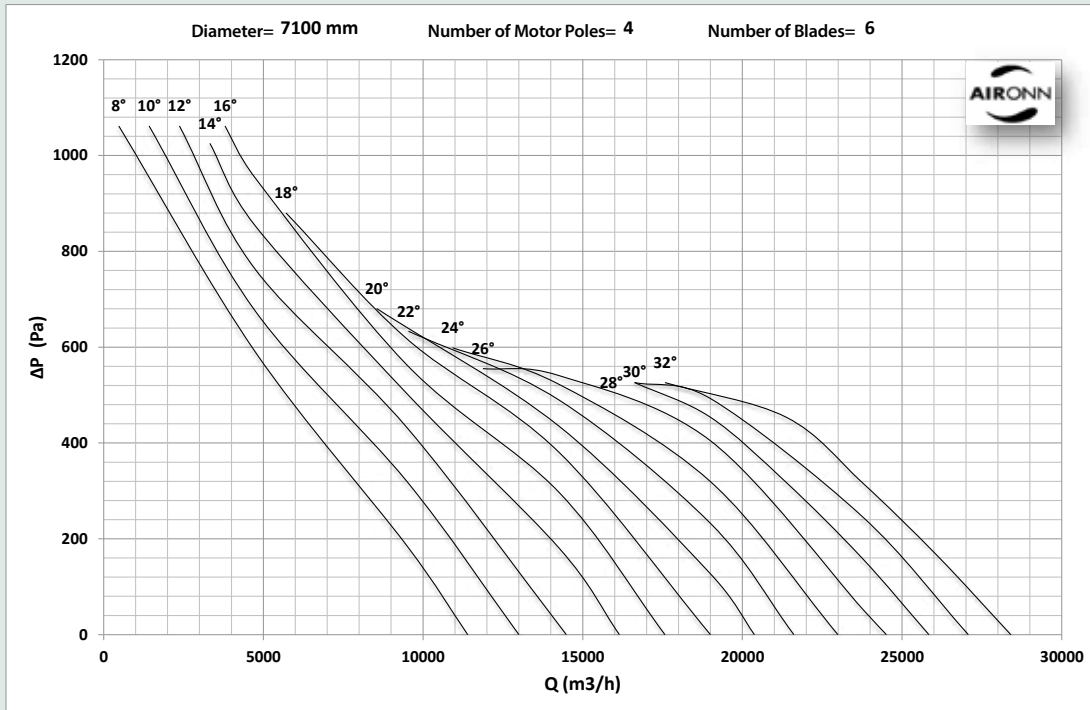

# Series Type Axial Smoke Exhaust Fan Series

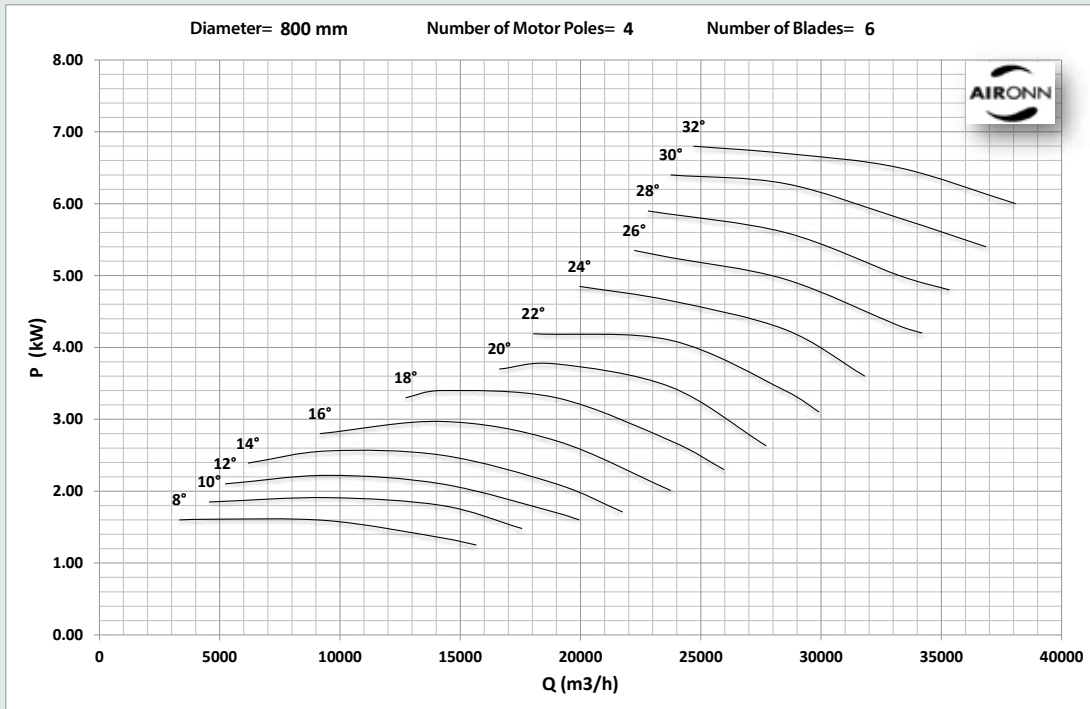
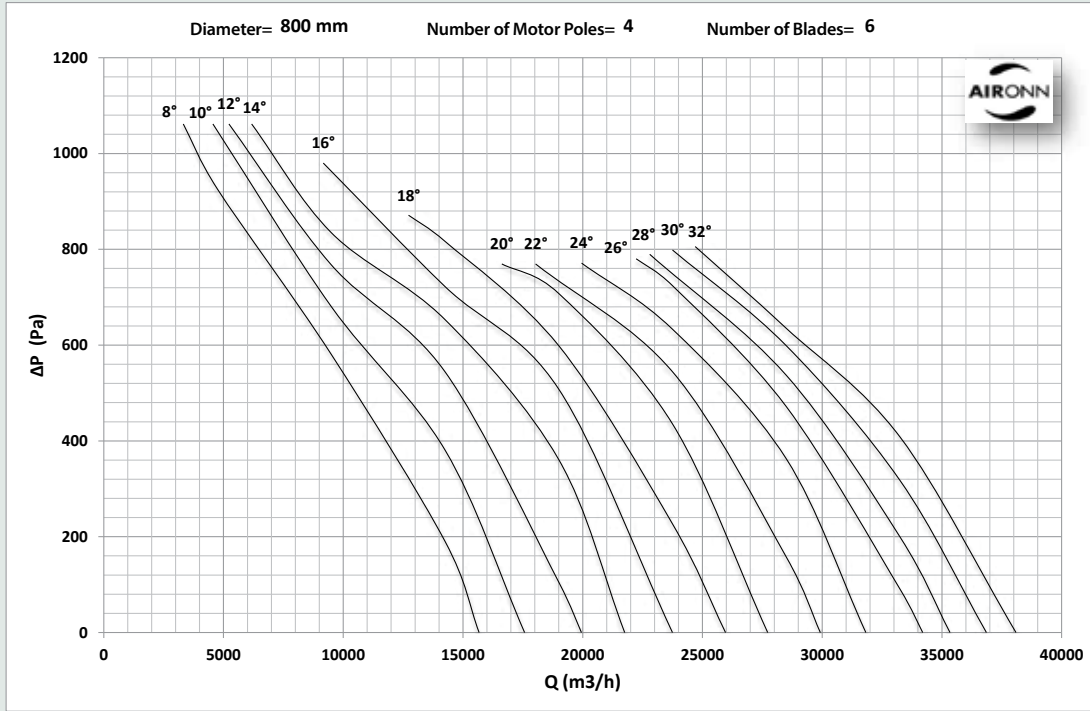



# Series Type Axial Smoke Exhaust Fan Series

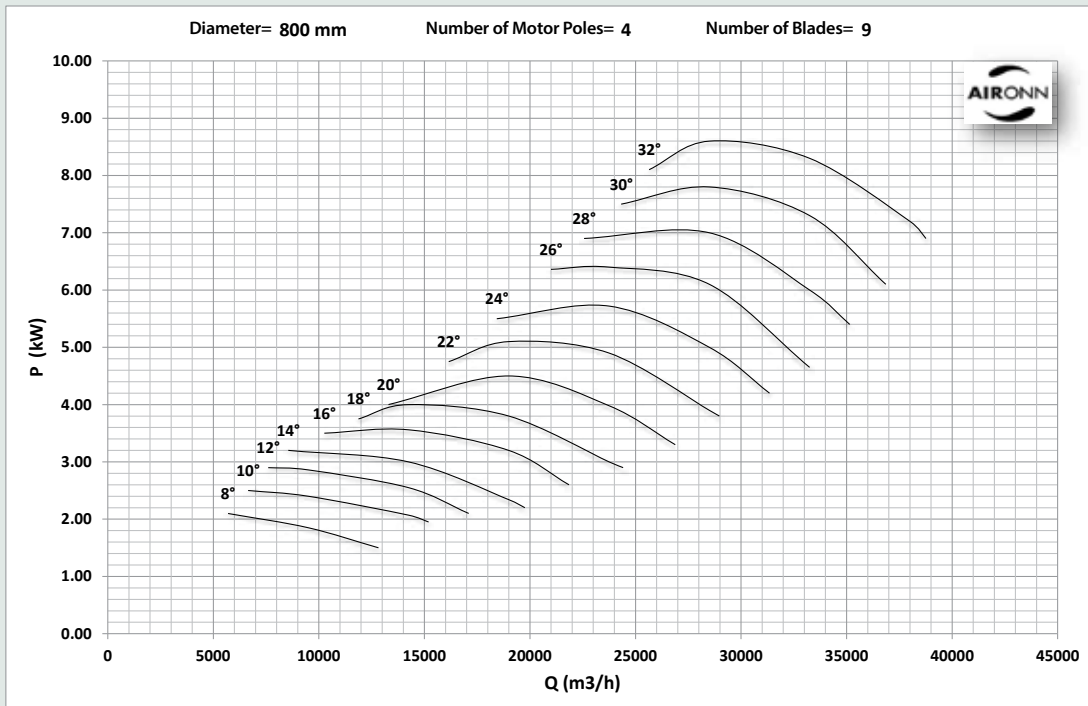
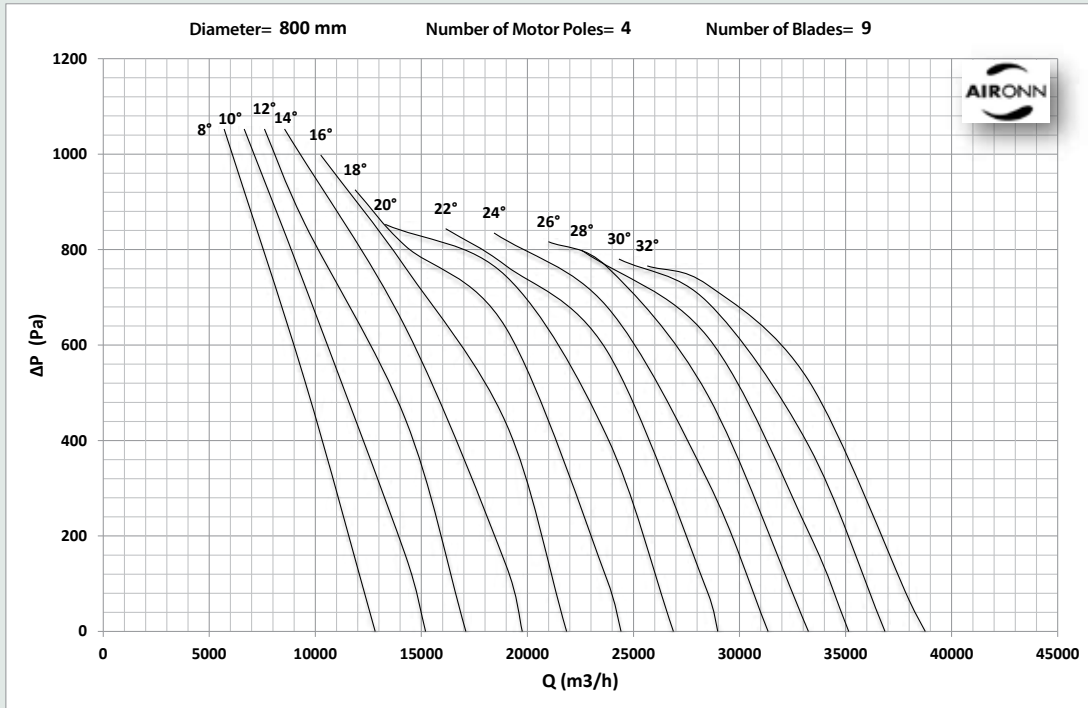

# Series Type Axial Smoke Exhaust Fan Series

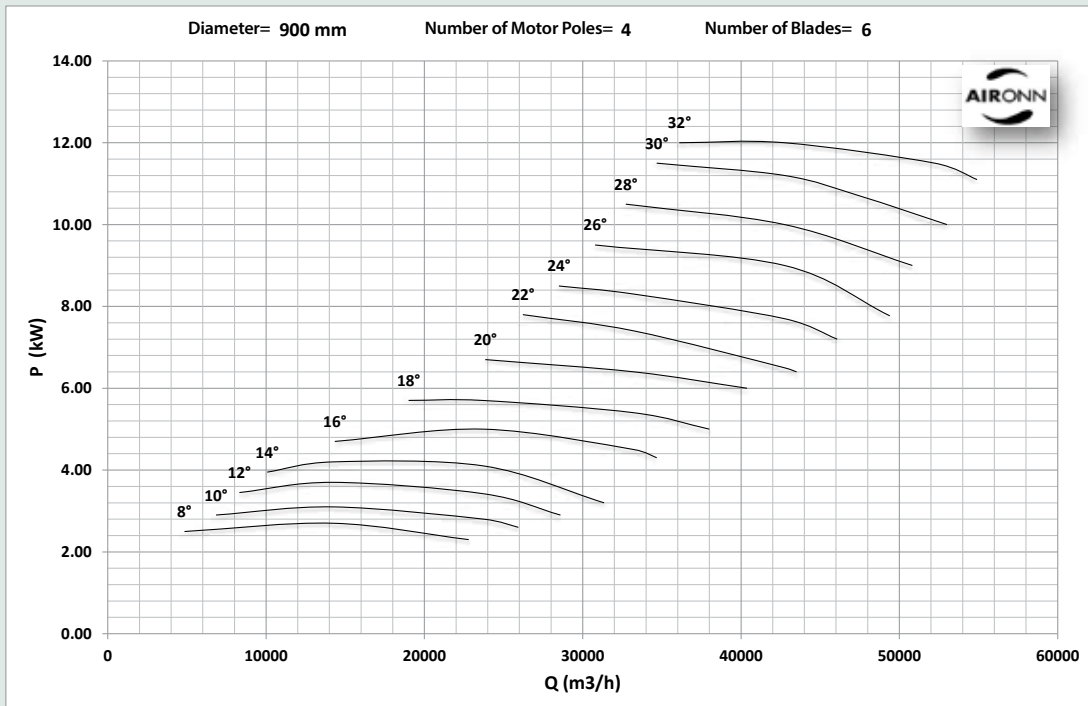
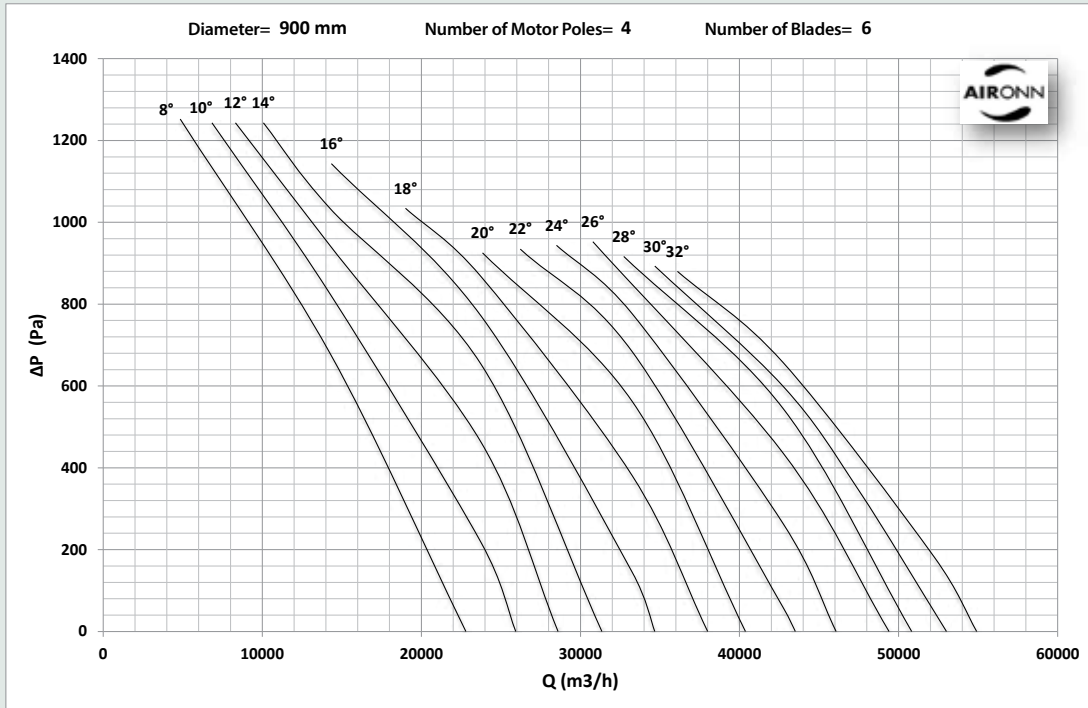

# Series Type Axial Smoke Exhaust Fan Series

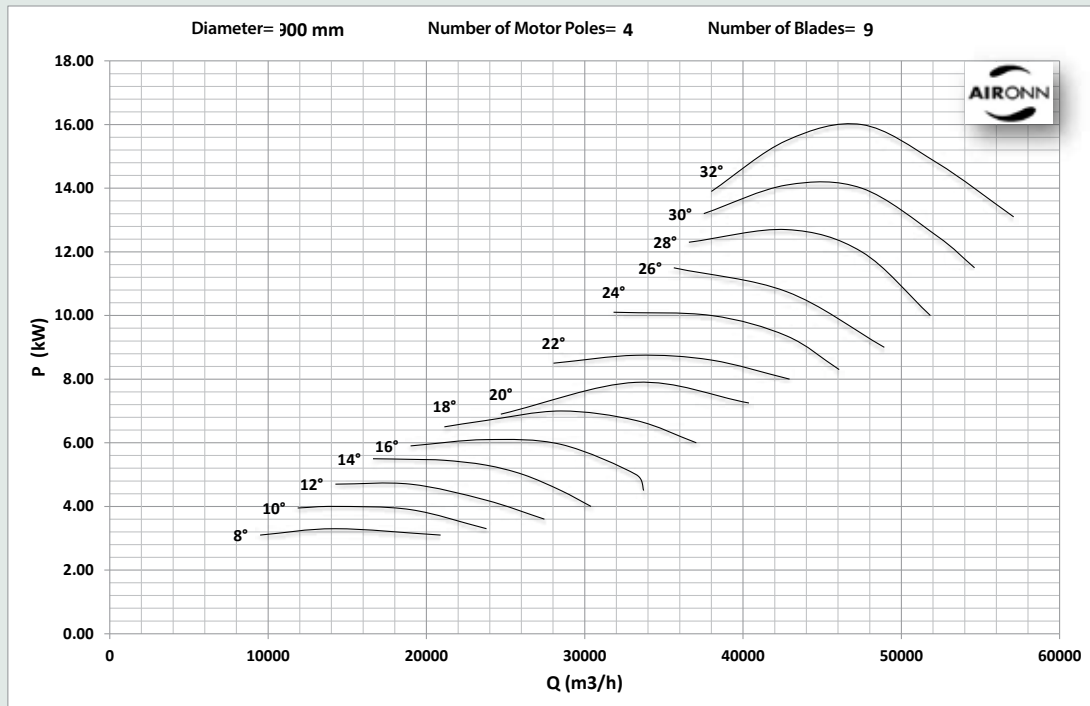
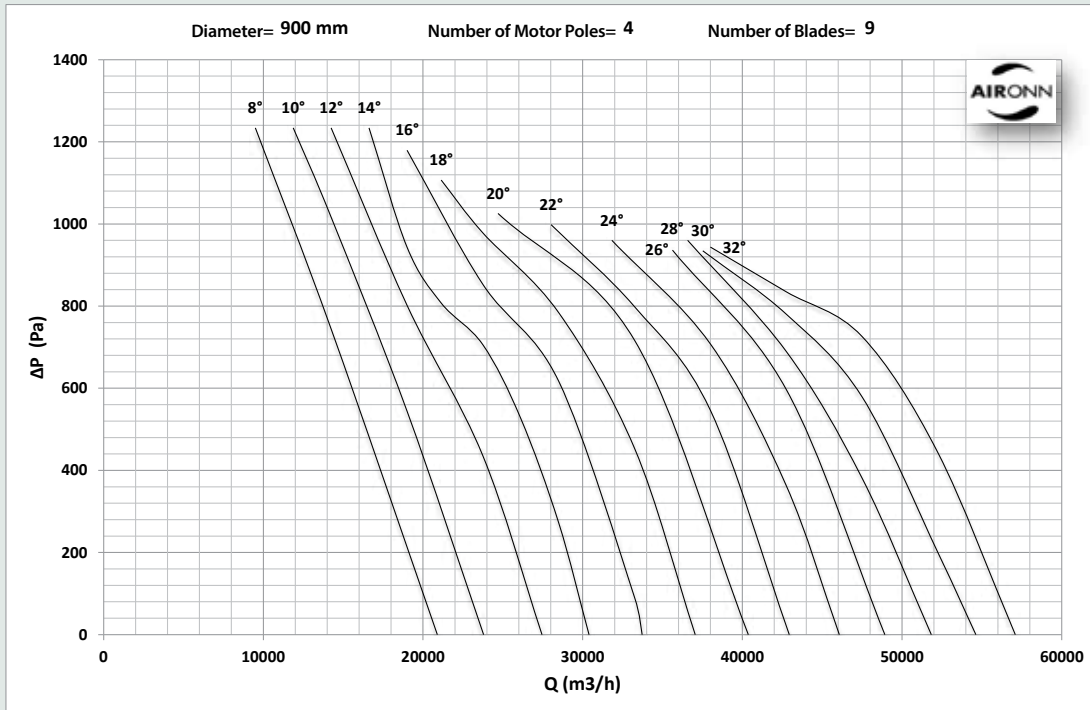

# Series Type Axial Smoke Exhaust Fan Series

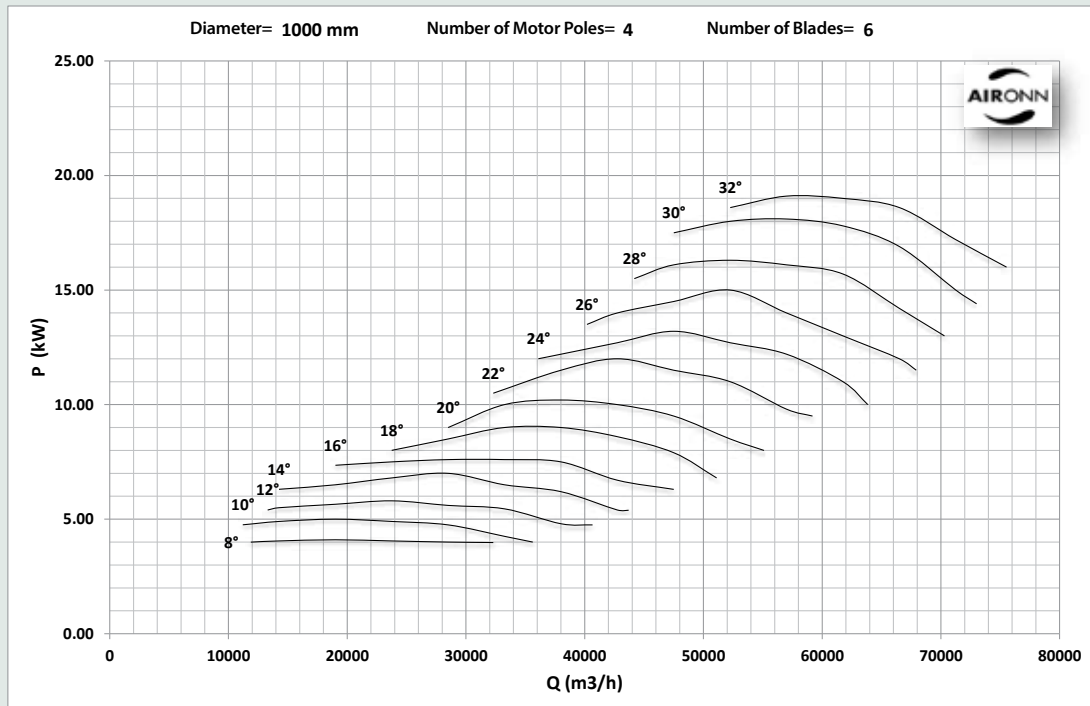
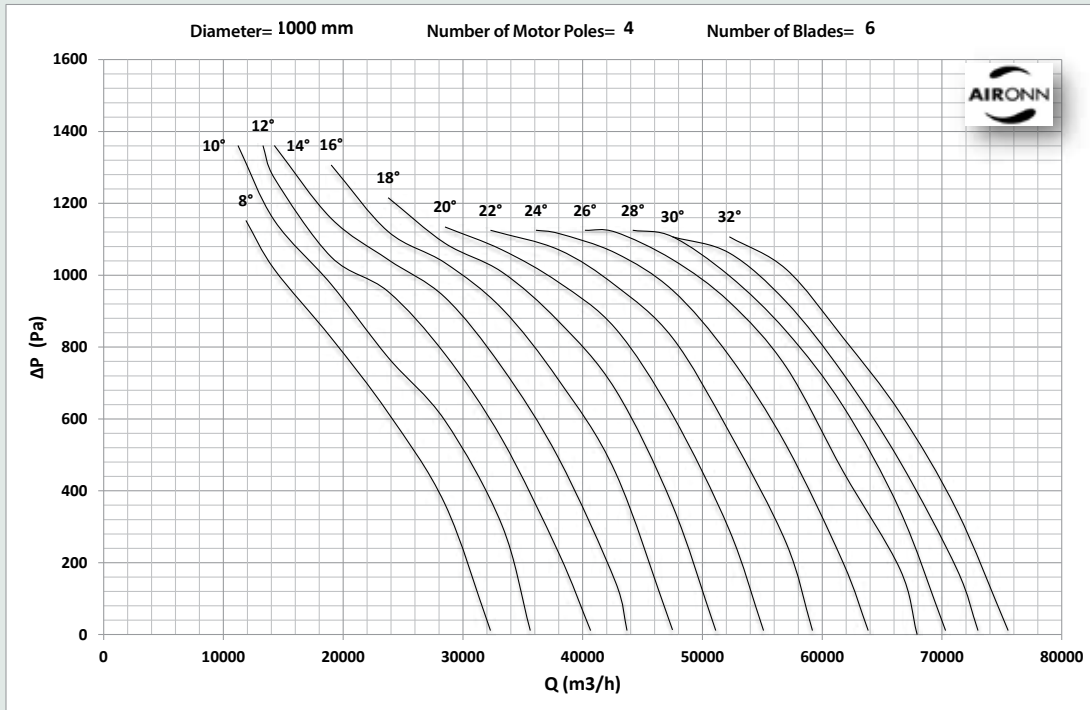

# Series Type Axial Smoke Exhaust Fan Series

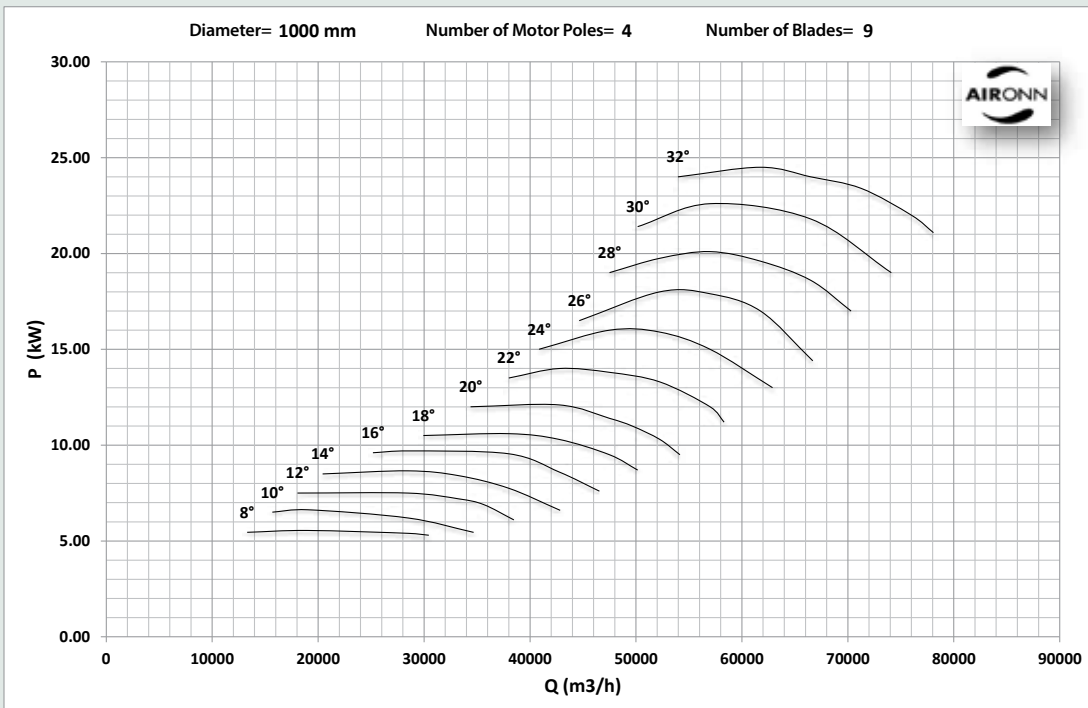
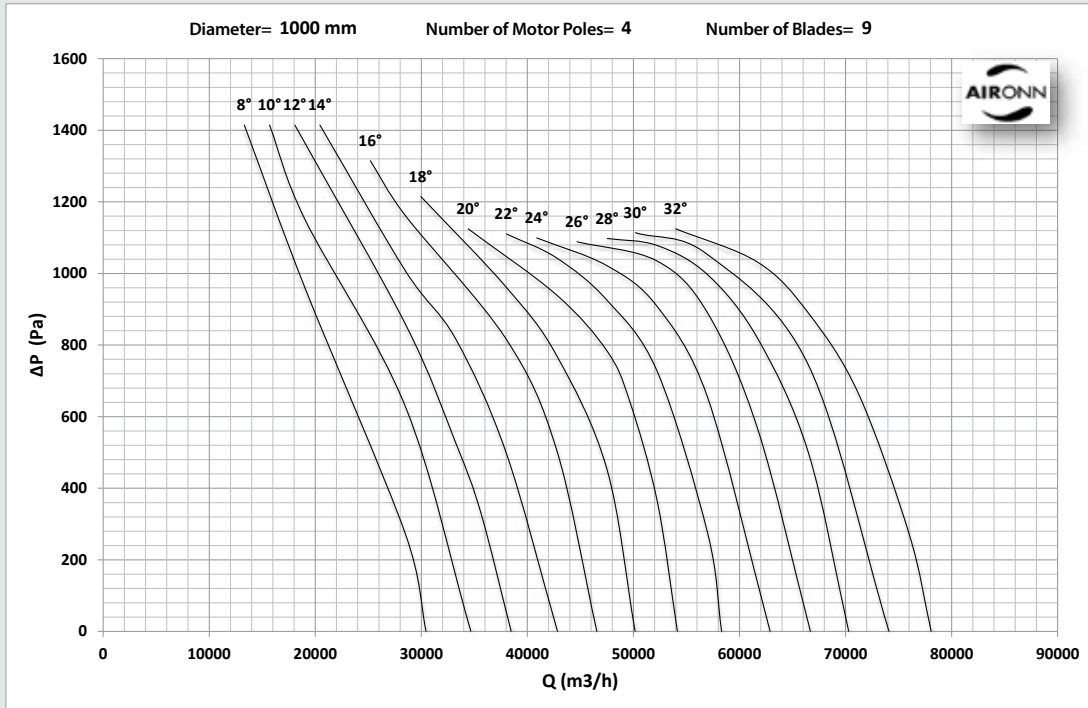

# Series Type Axial Smoke Exhaust Fan Series

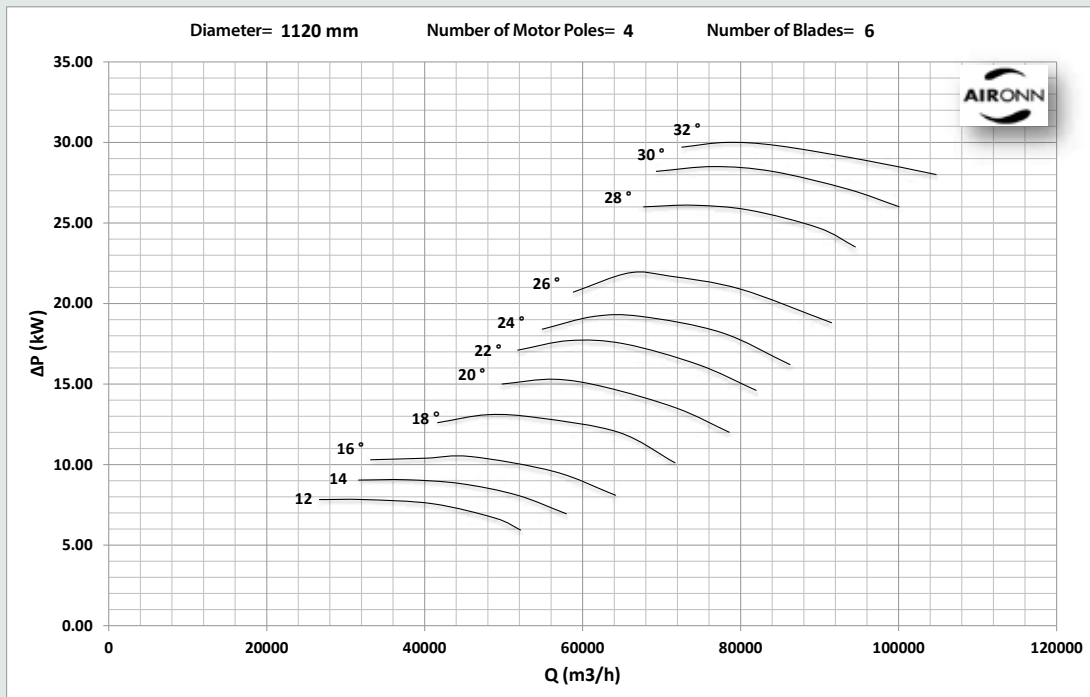
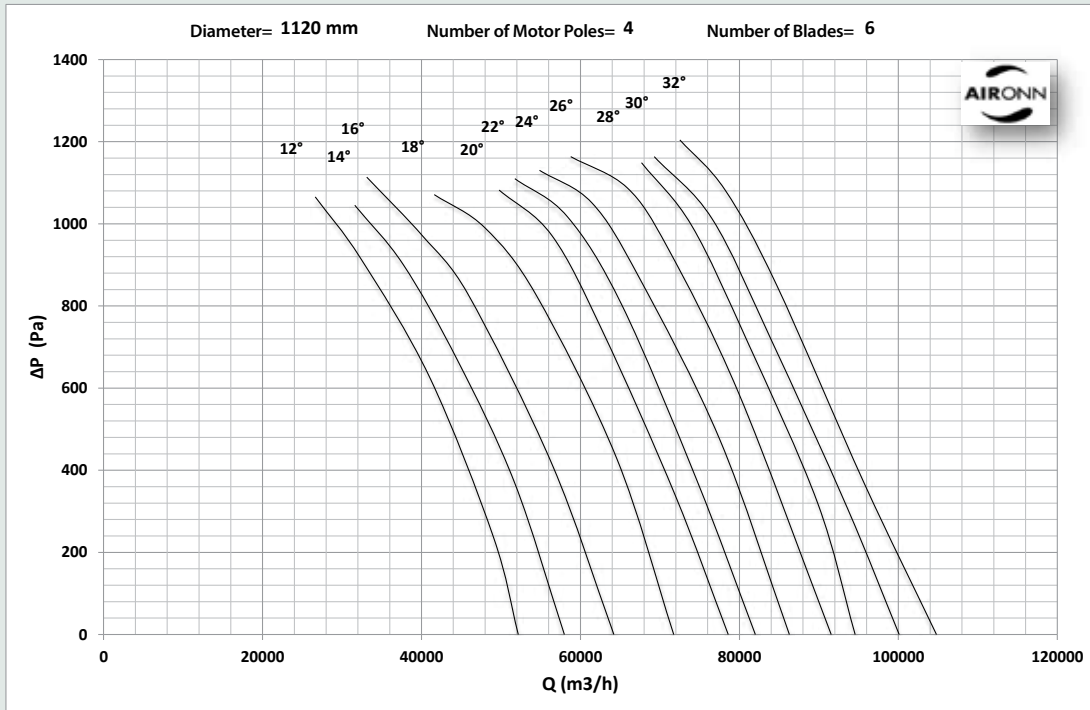

# Series Type Axial Smoke Exhaust Fan Series

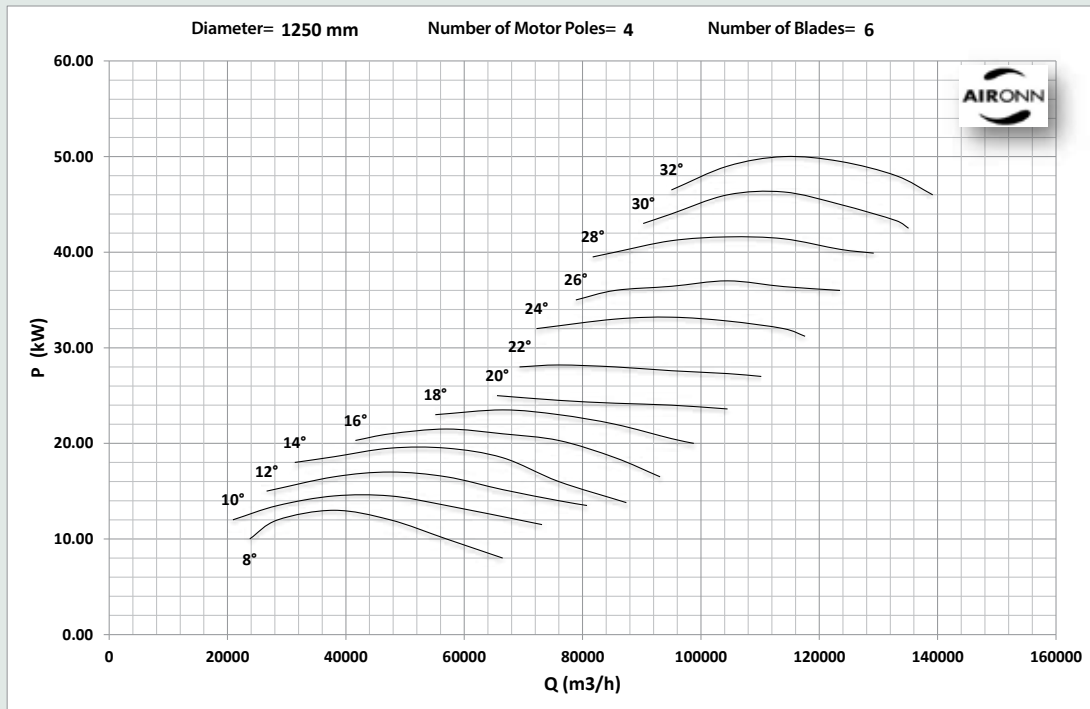
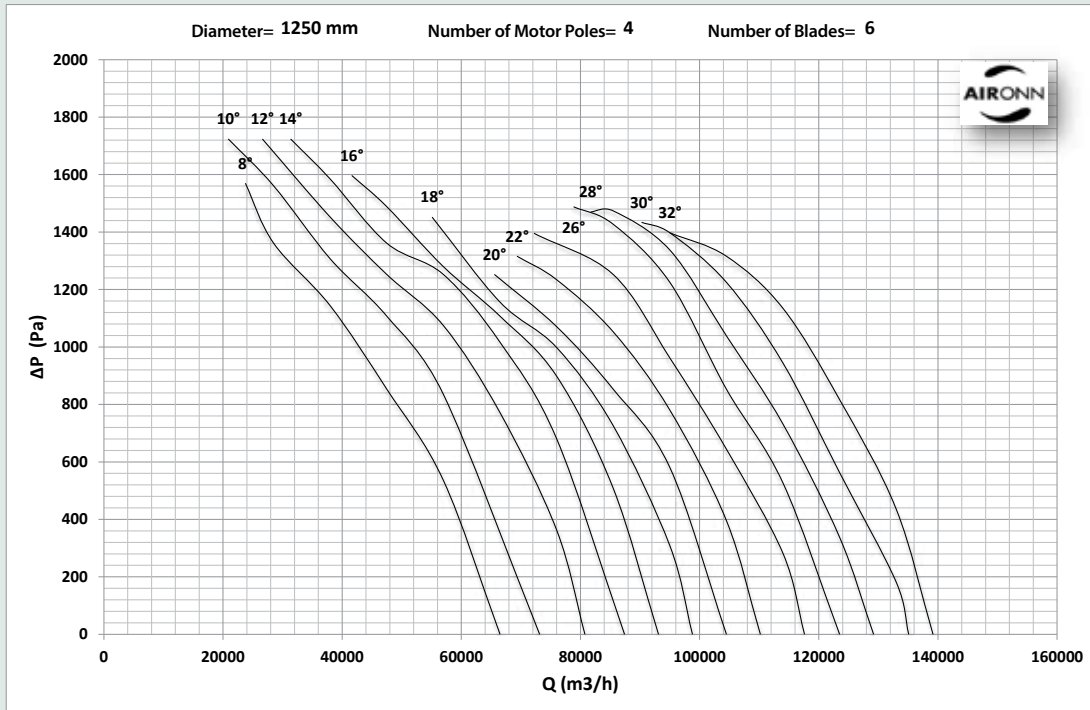

# Series Type Axial Smoke Exhaust Fan Series

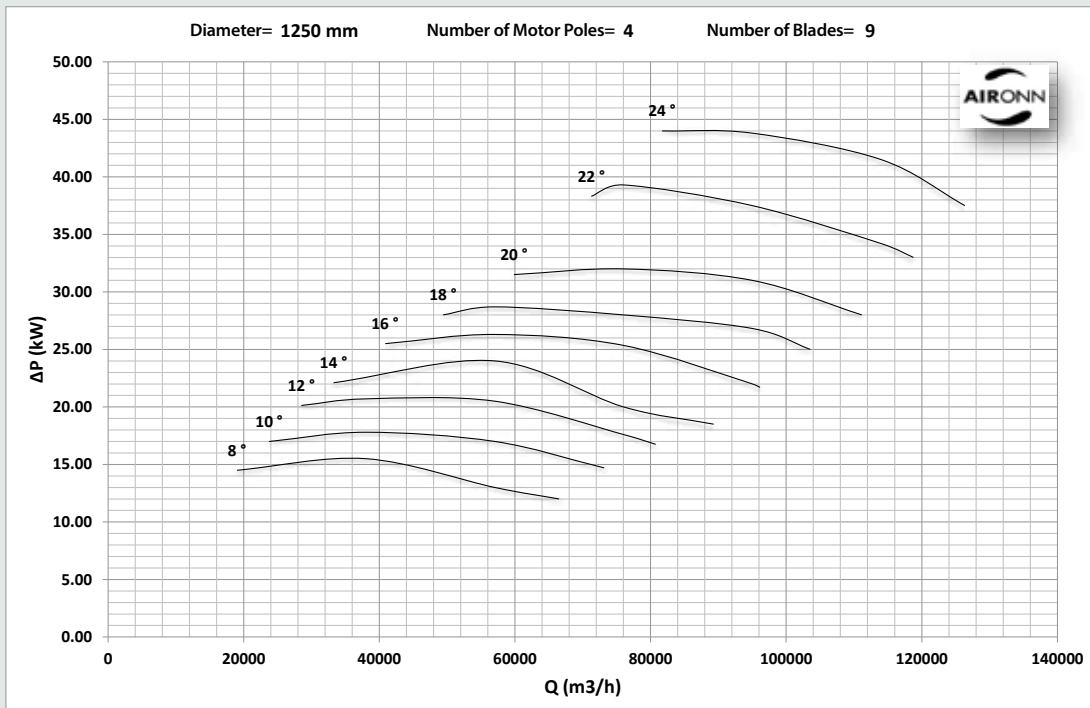
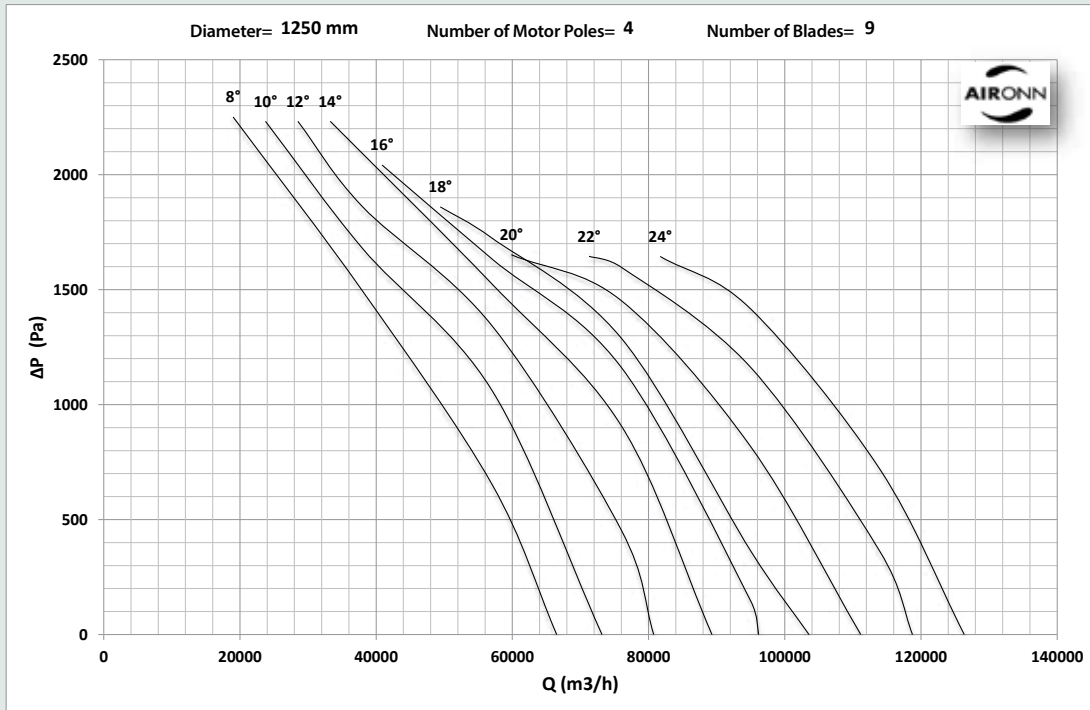



# Series Type Axial Smoke Exhaust Fan Series

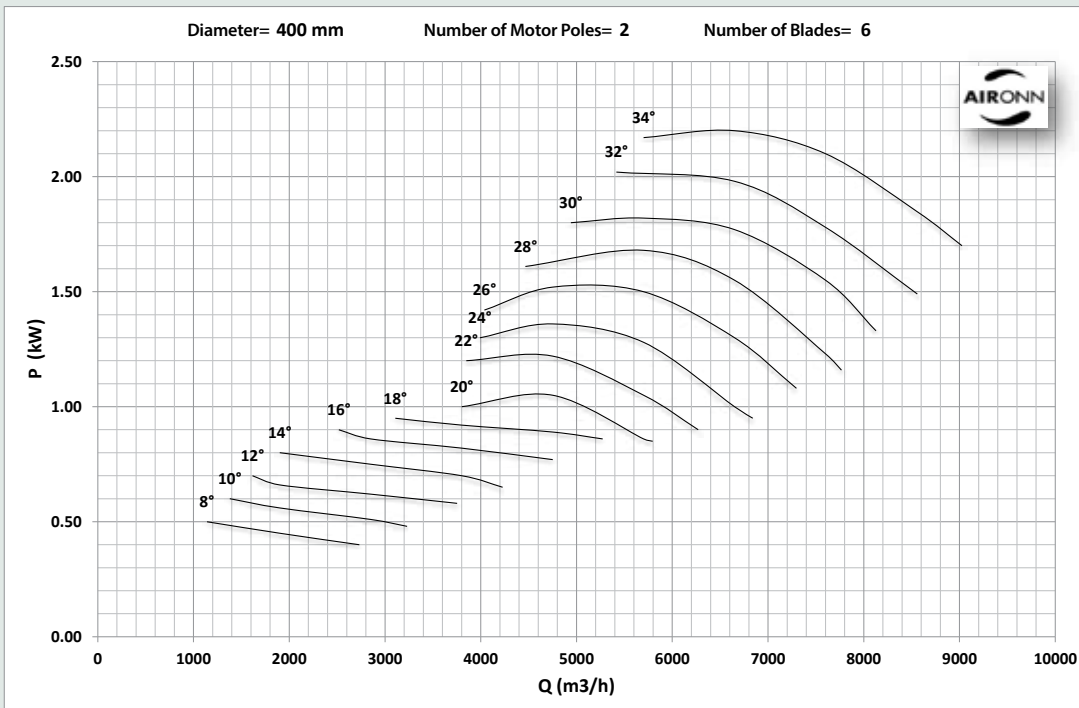
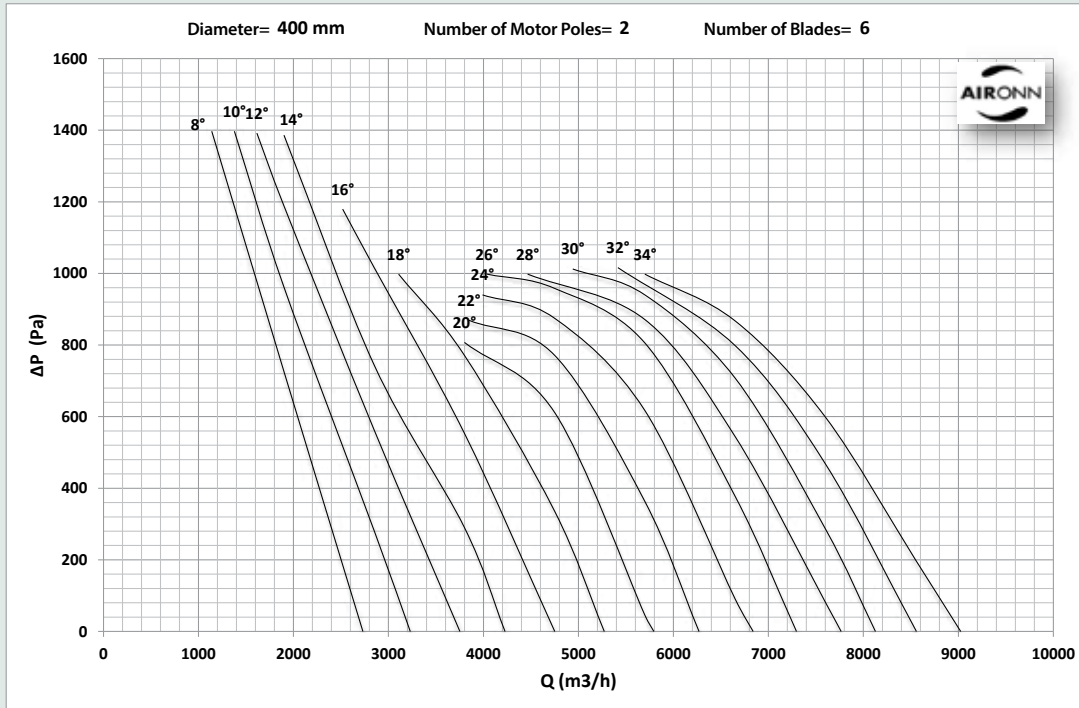

# Series Type Axial Smoke Exhaust Fan Series

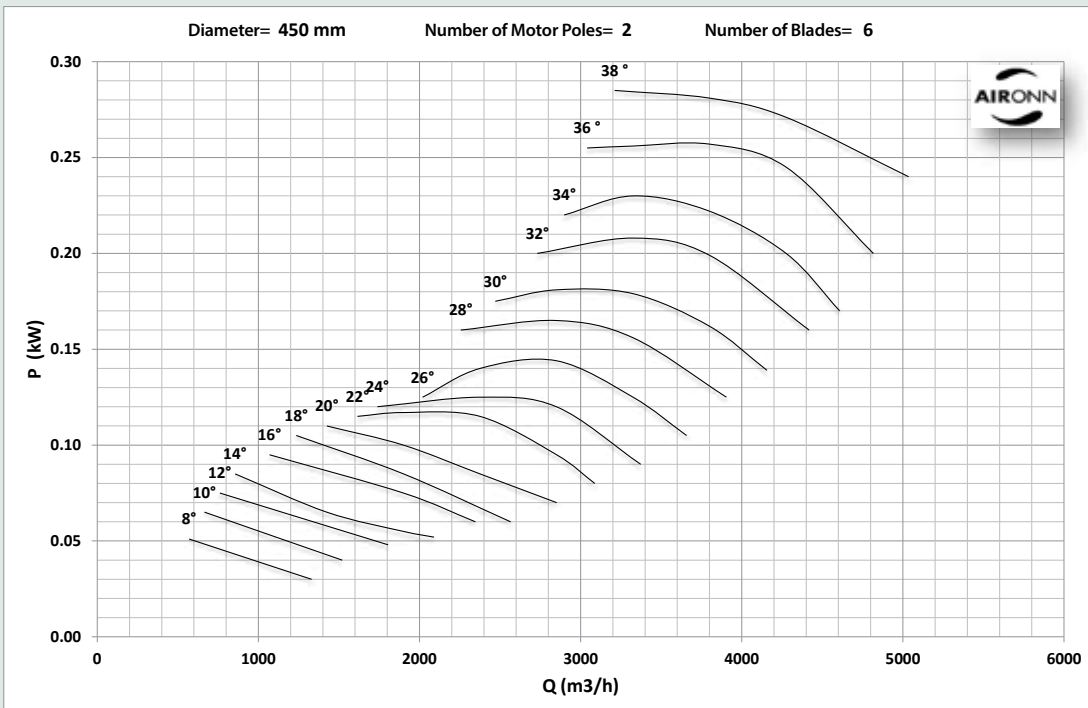
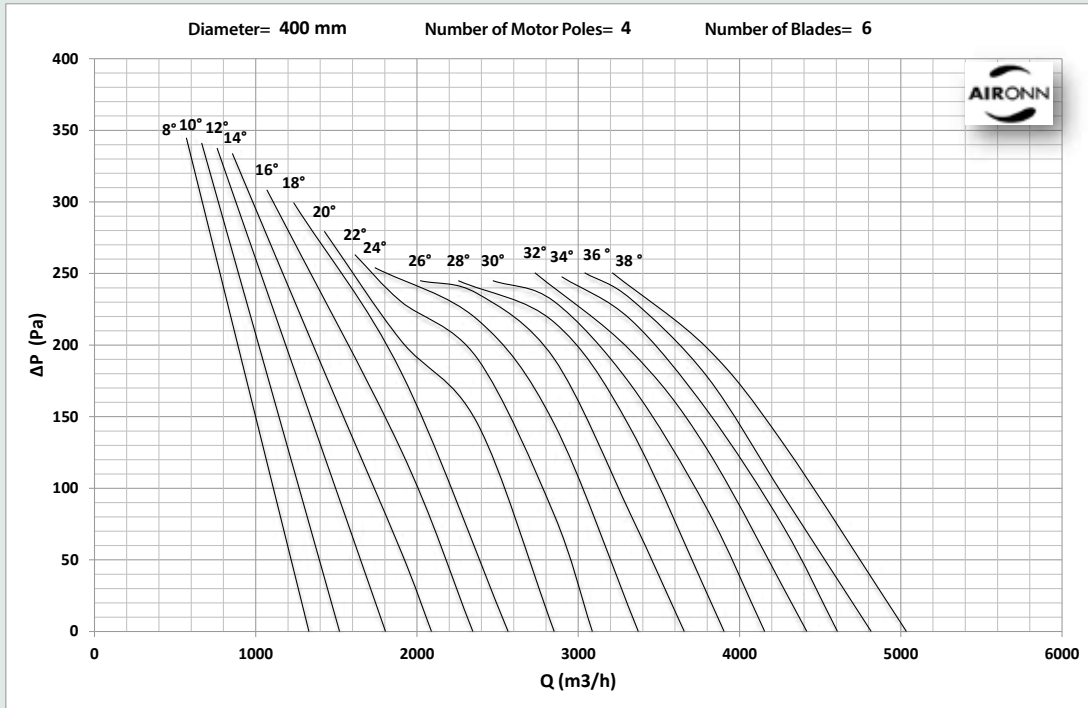

# Series Type Axial Smoke Exhaust Fan Series

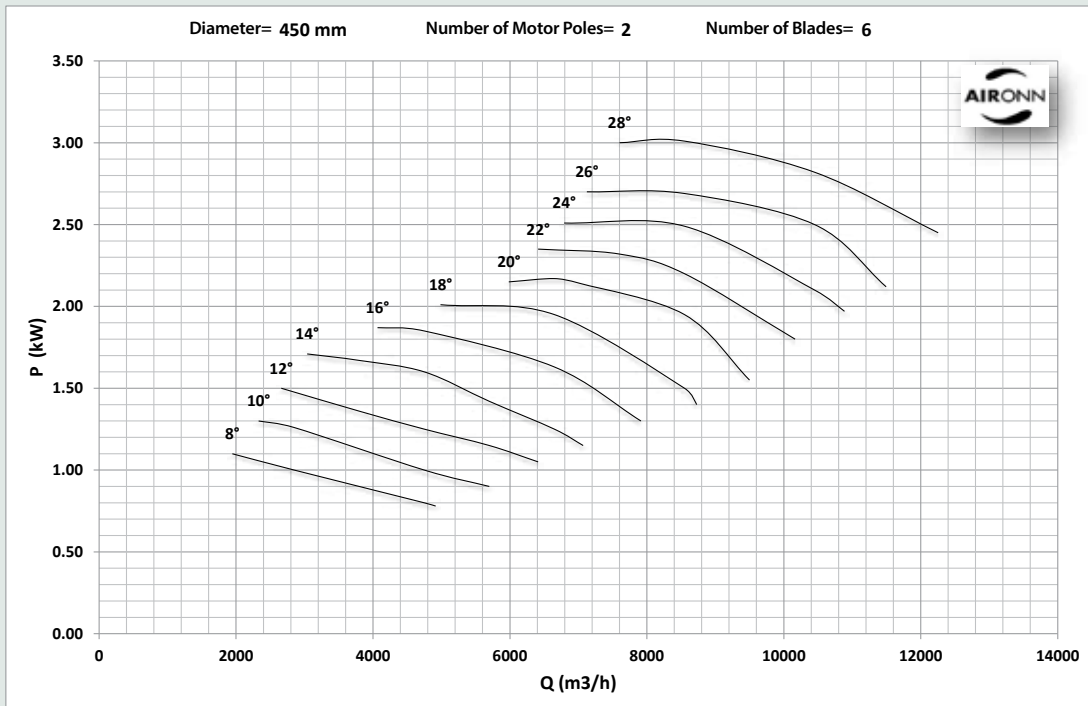
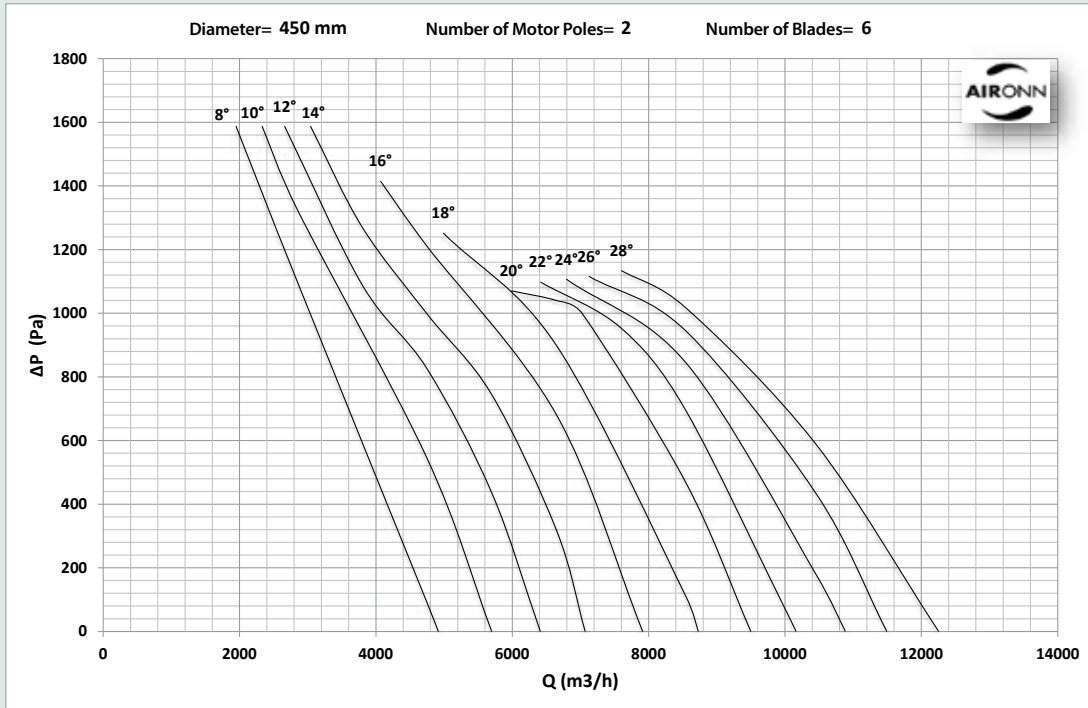

# Series Type Axial Smoke Exhaust Fan Series

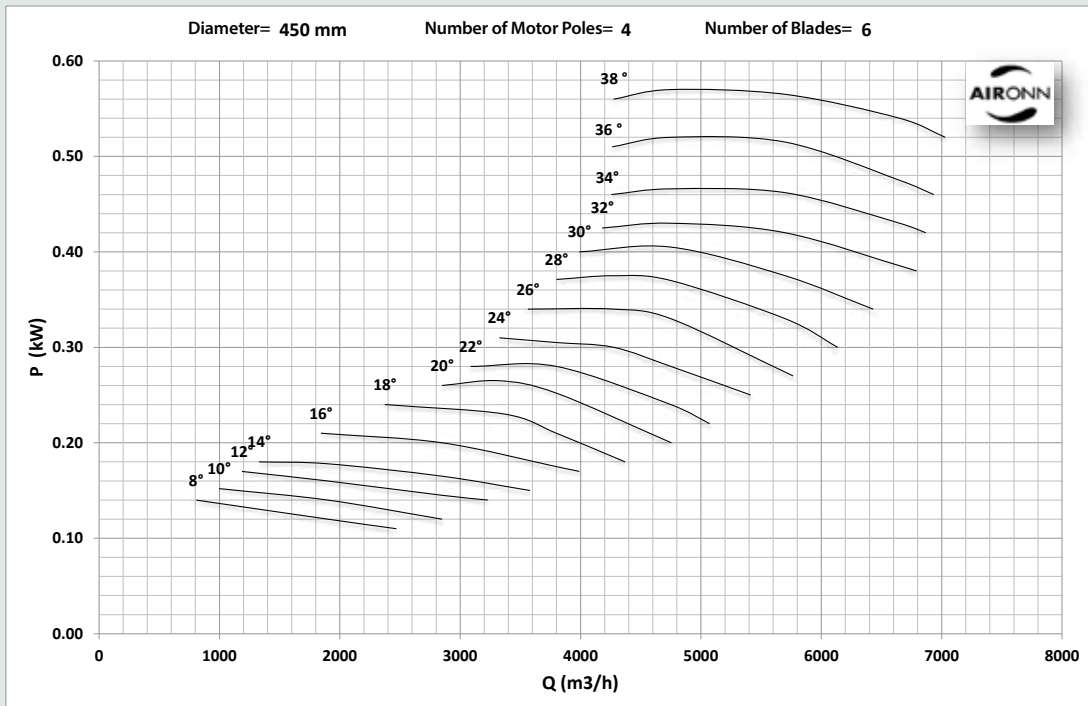
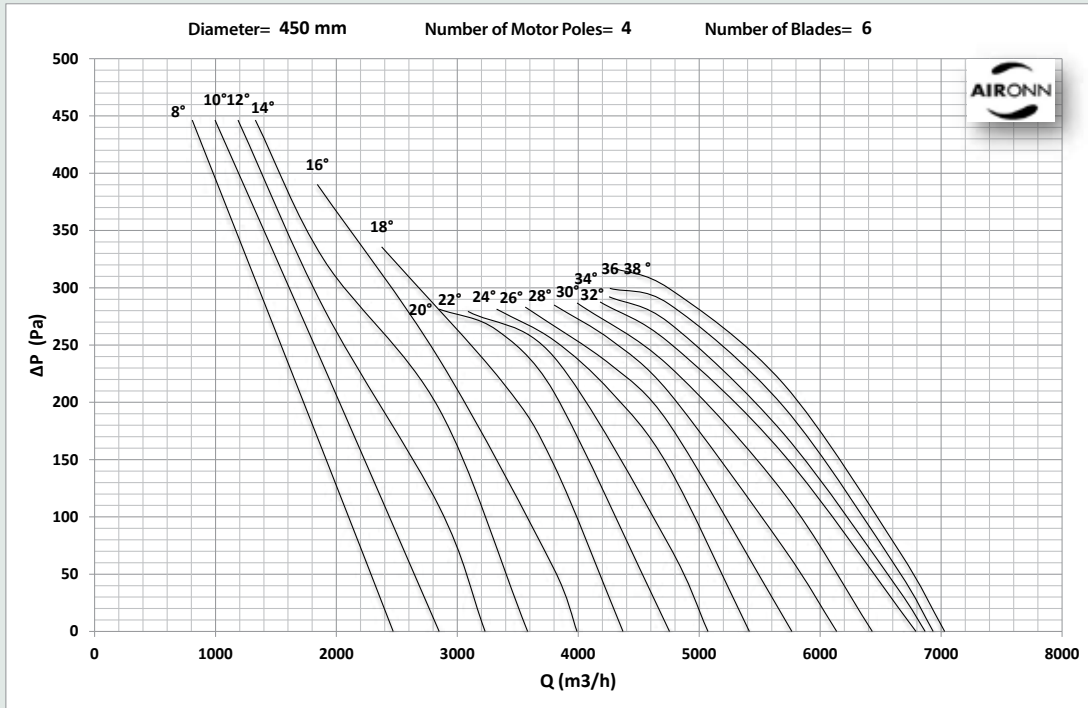

# Series Type Axial Smoke Exhaust Fan Series

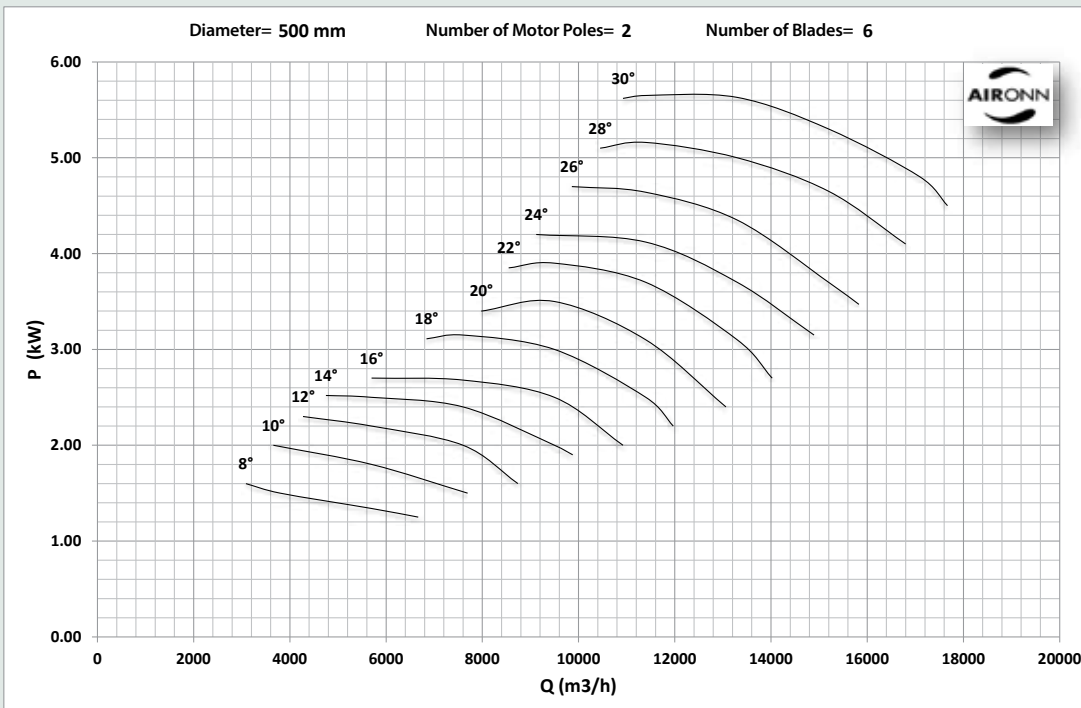
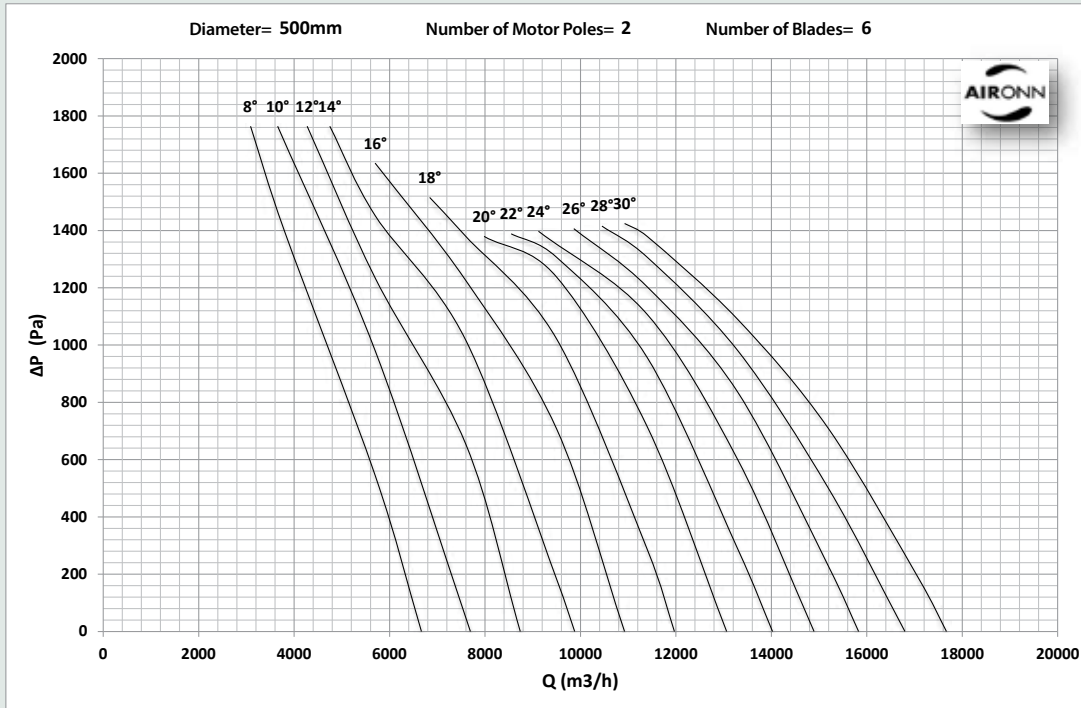

# Series Type Axial Smoke Exhaust Fan Series

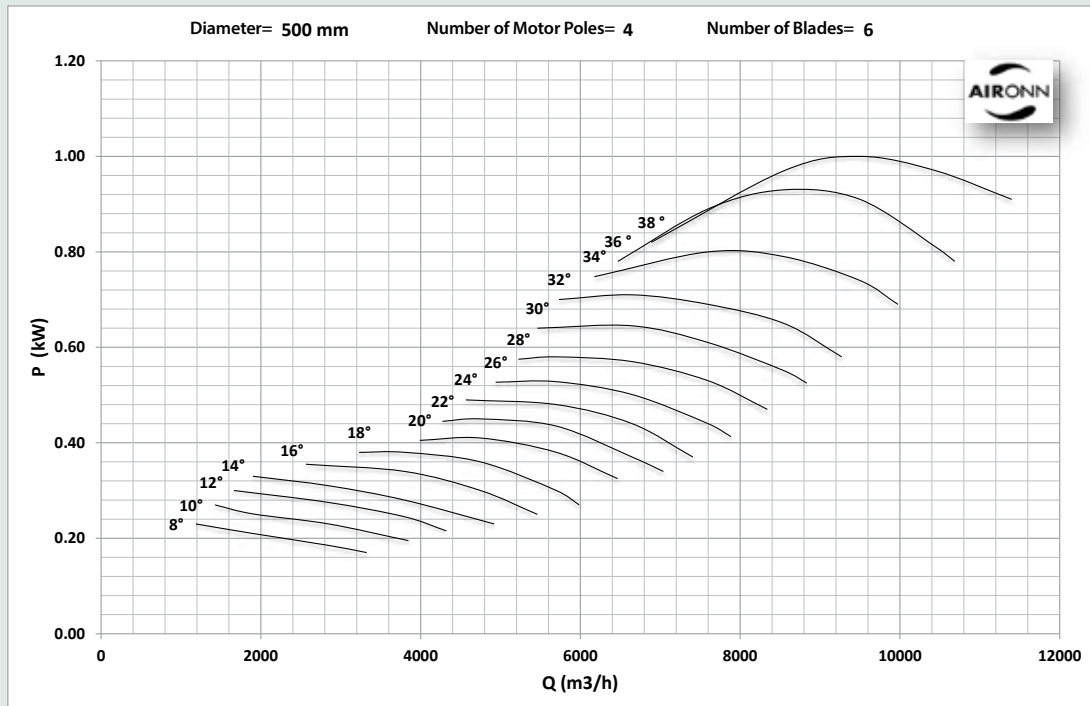
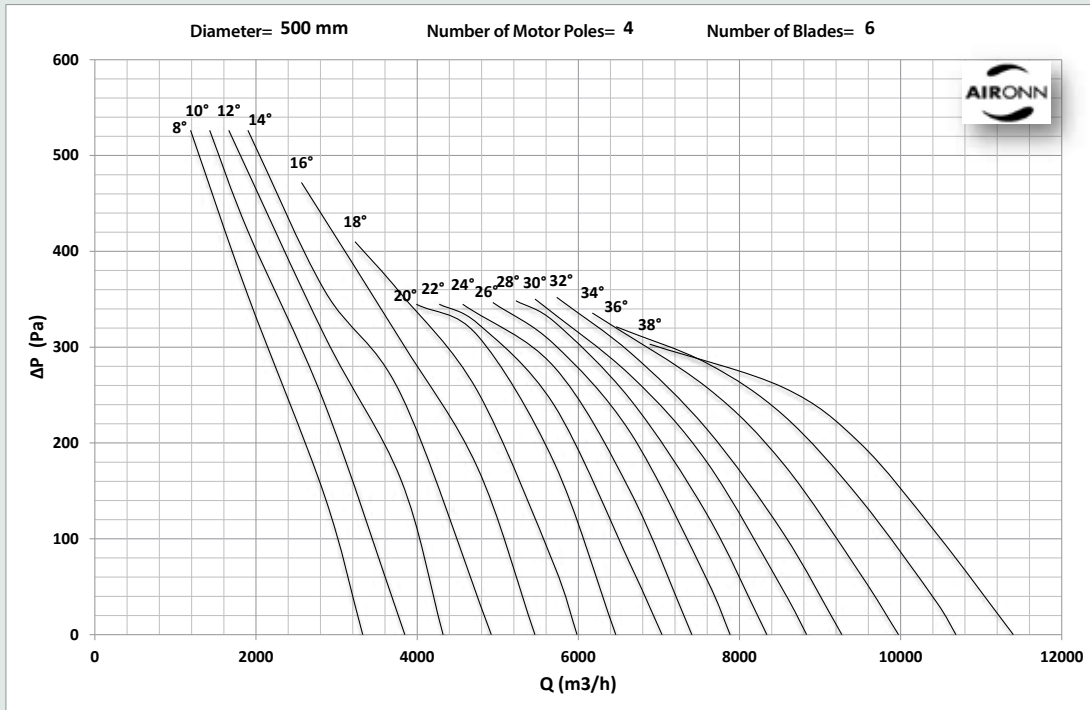

# Series Type Axial Smoke Exhaust Fan Series

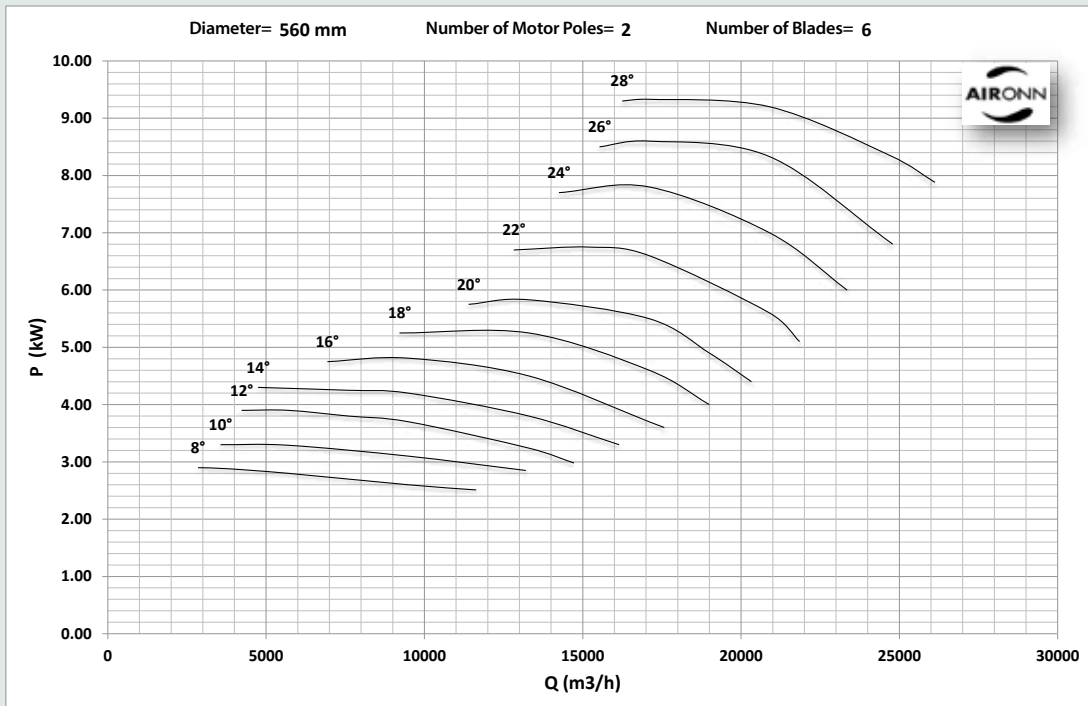
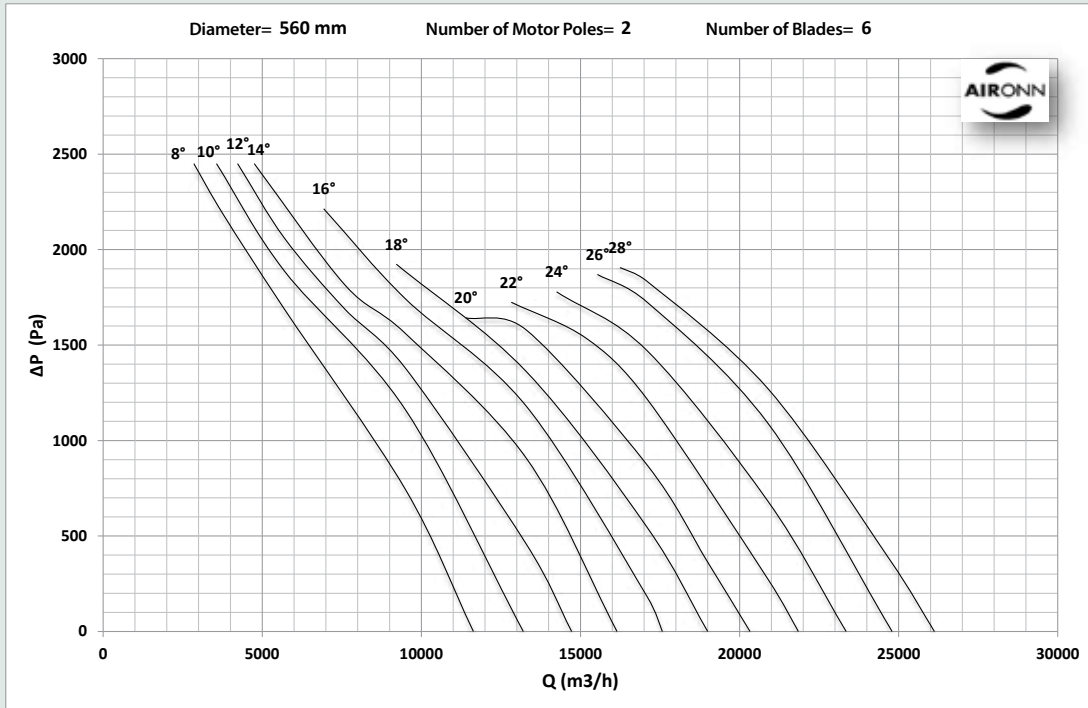

# Series Type Axial Smoke Exhaust Fan Series

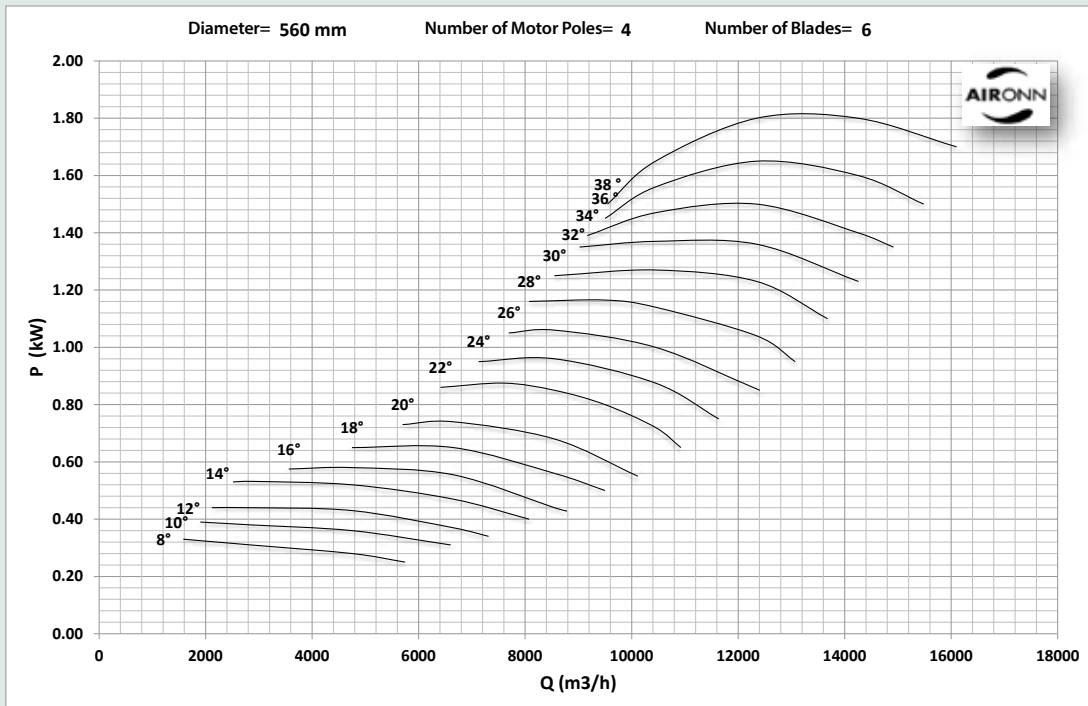
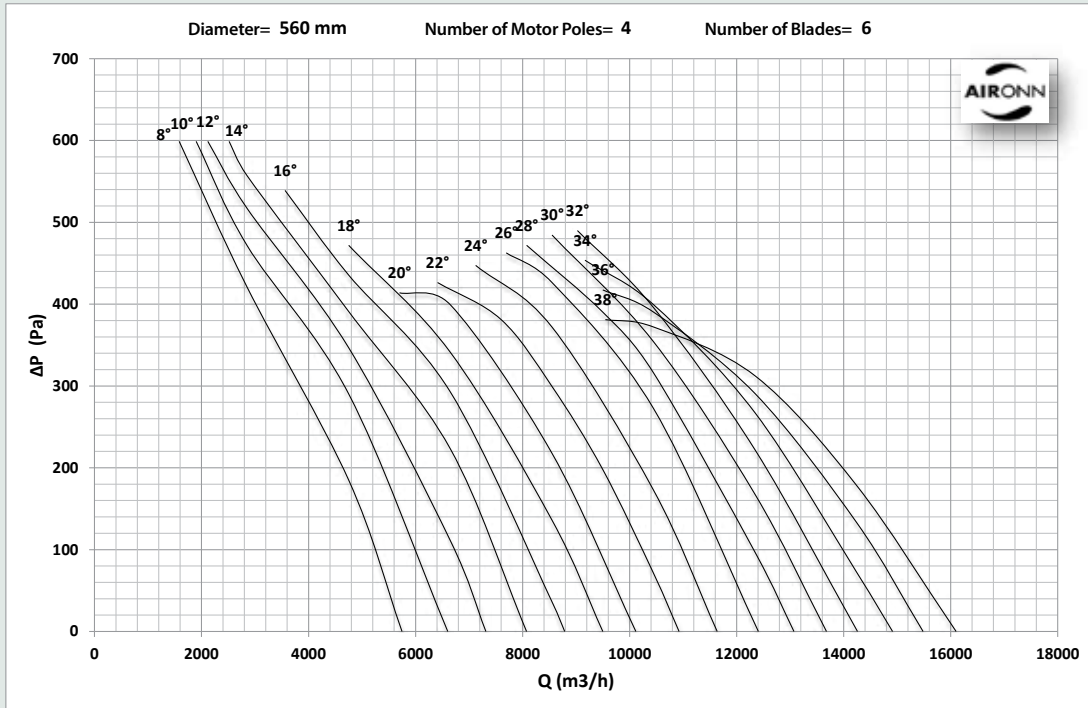



# Series Type Axial Smoke Exhaust Fan Series

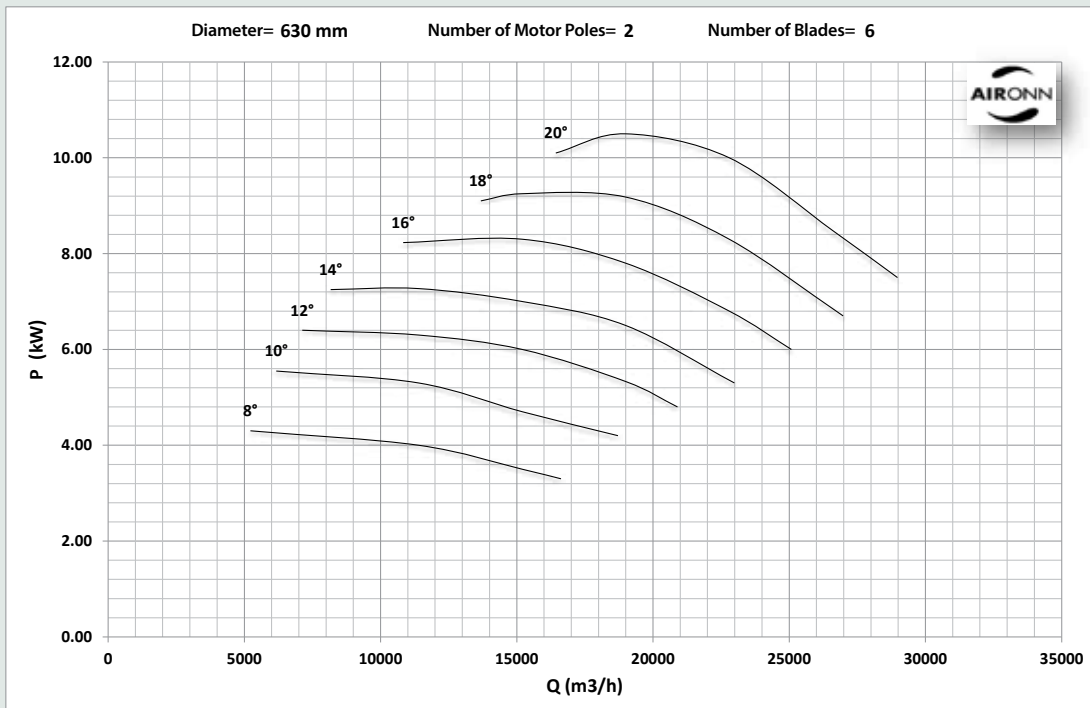
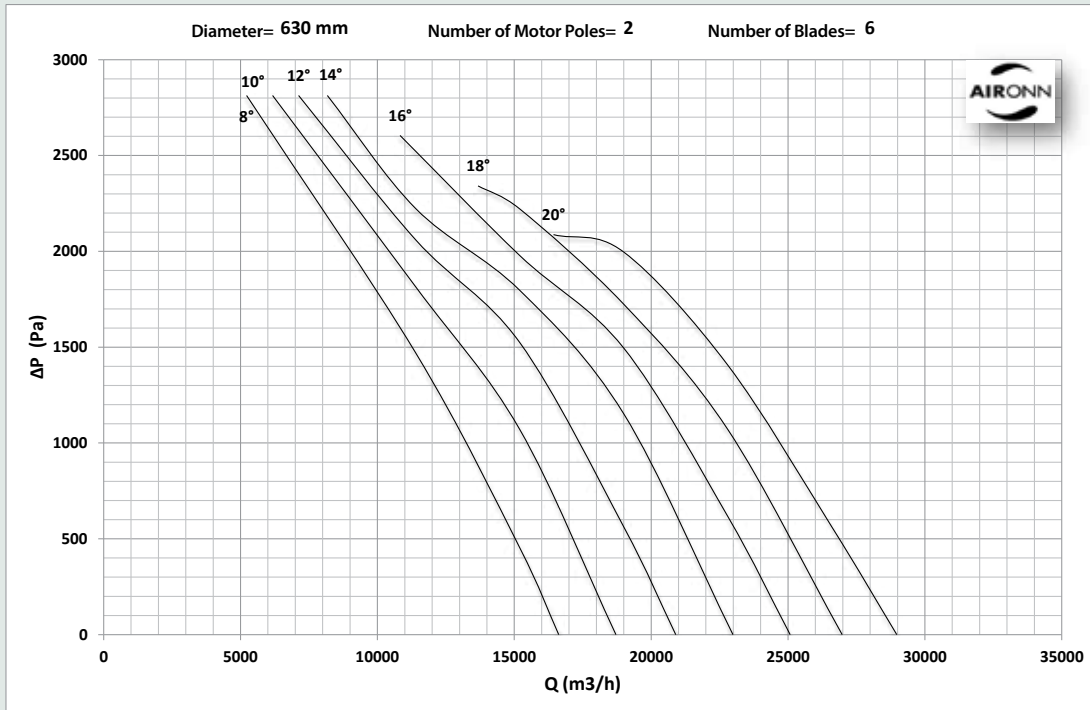

# Series Type Axial Smoke Exhaust Fan Series

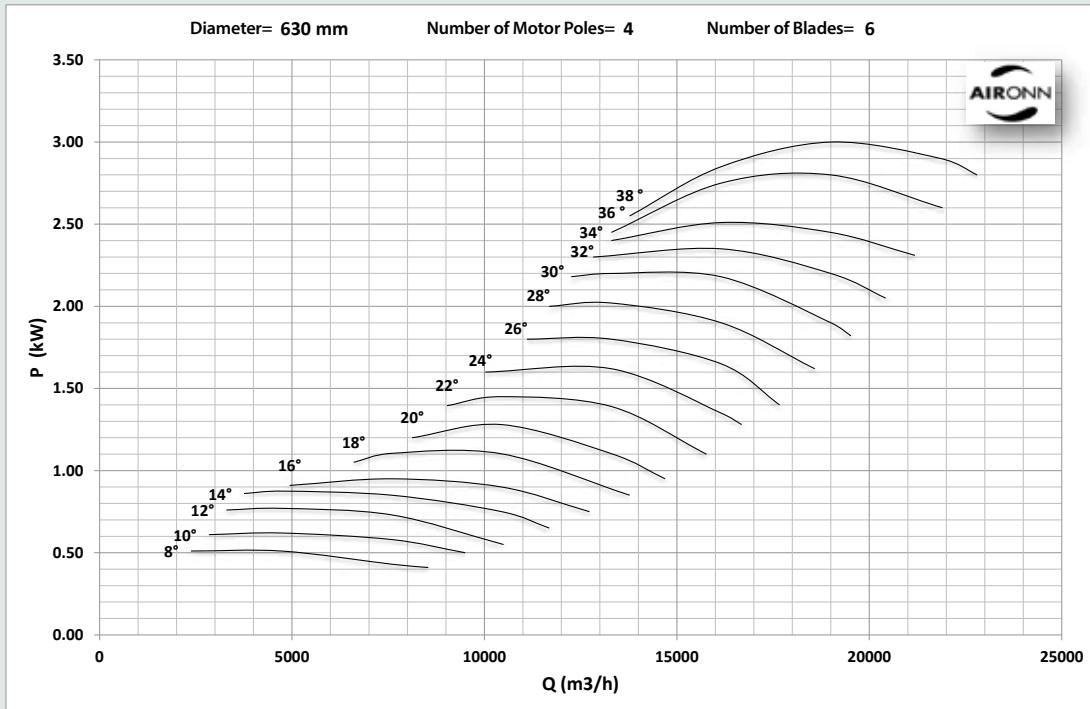
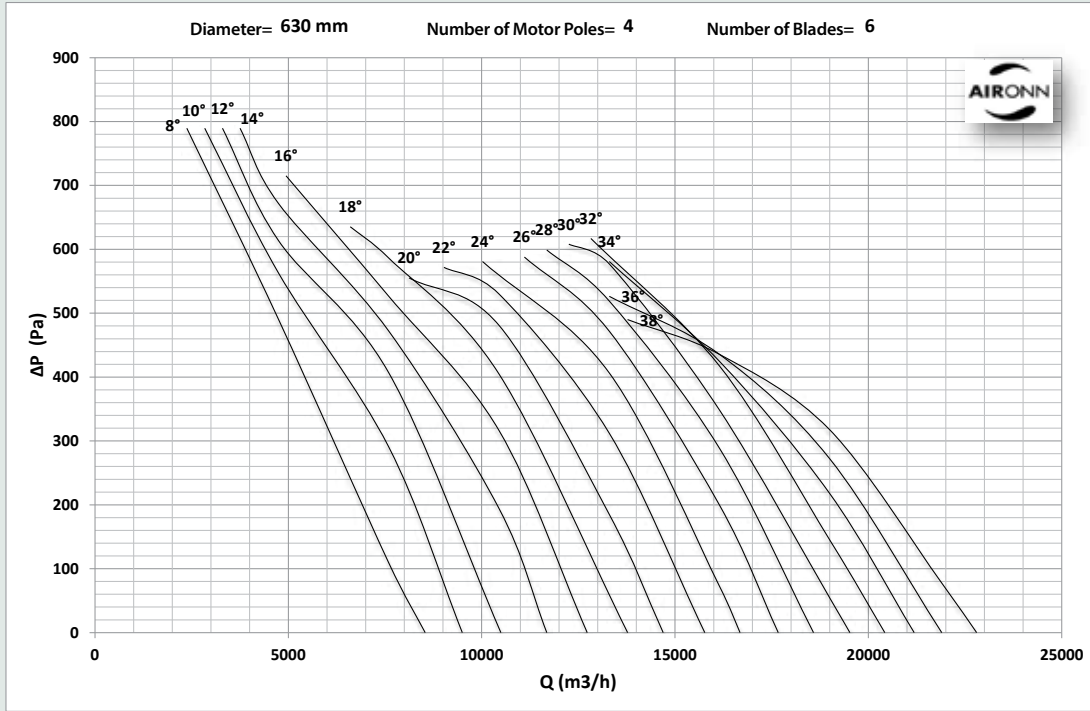

# Series Type Axial Smoke Exhaust Fan Series

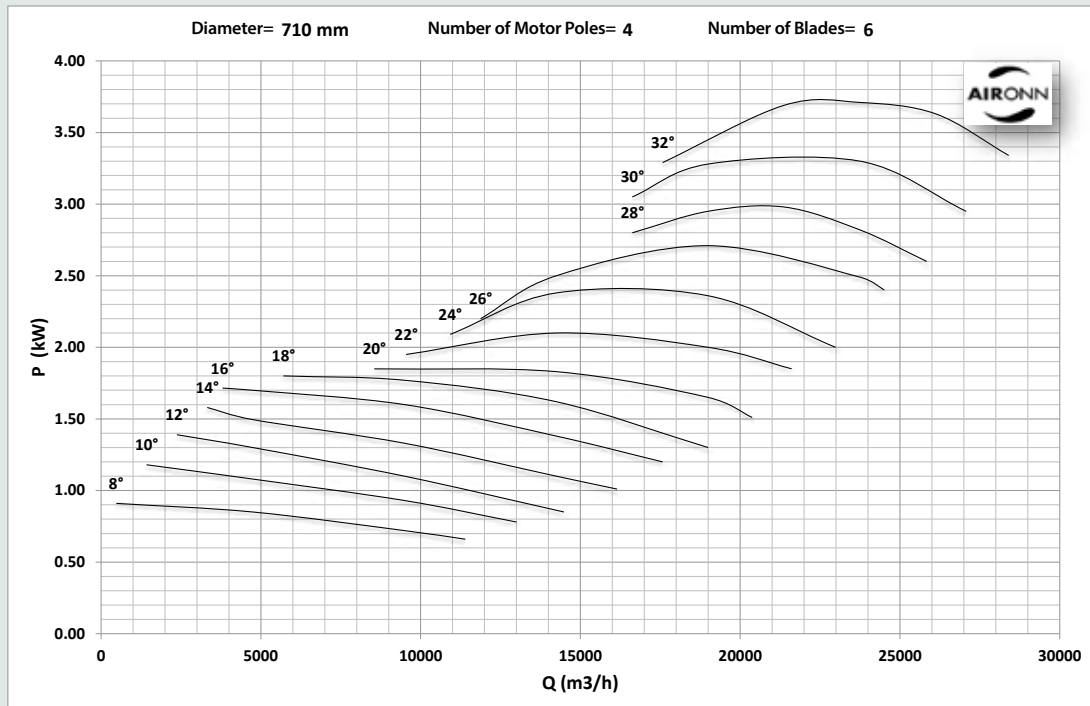
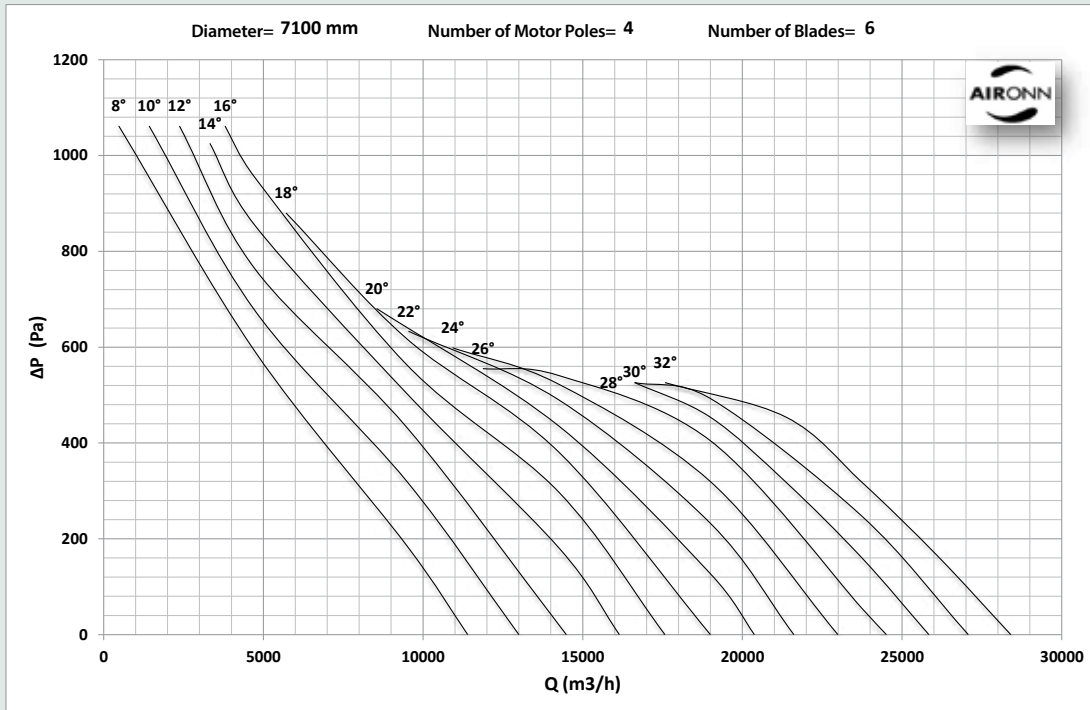

# Series Type Axial Smoke Exhaust Fan Series

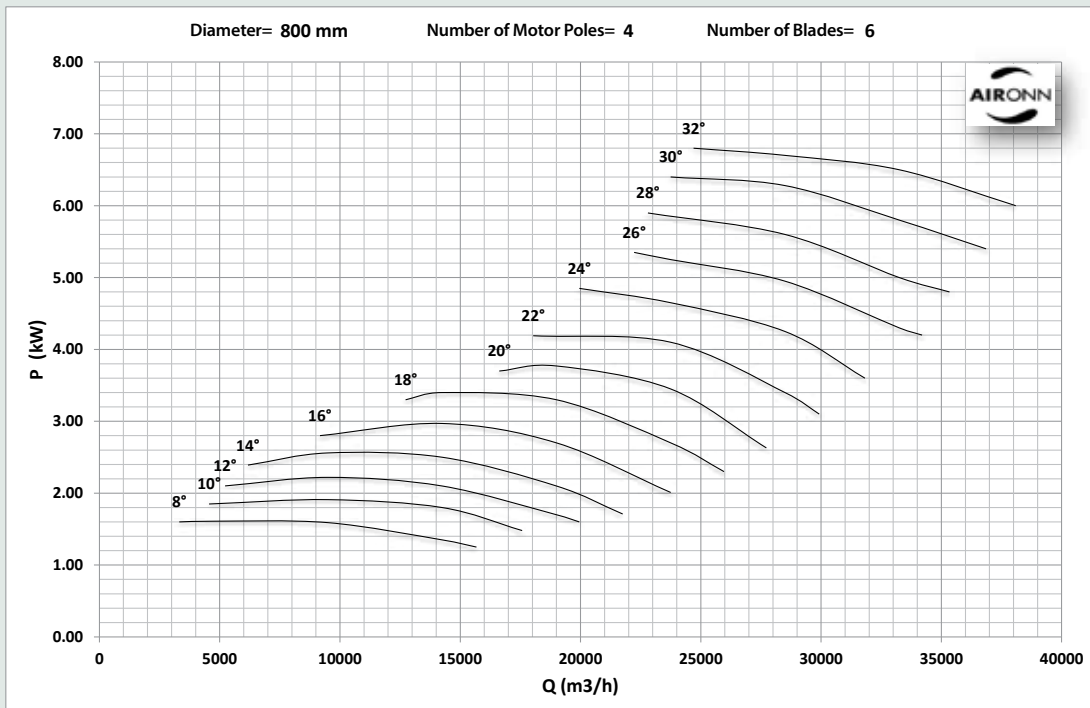
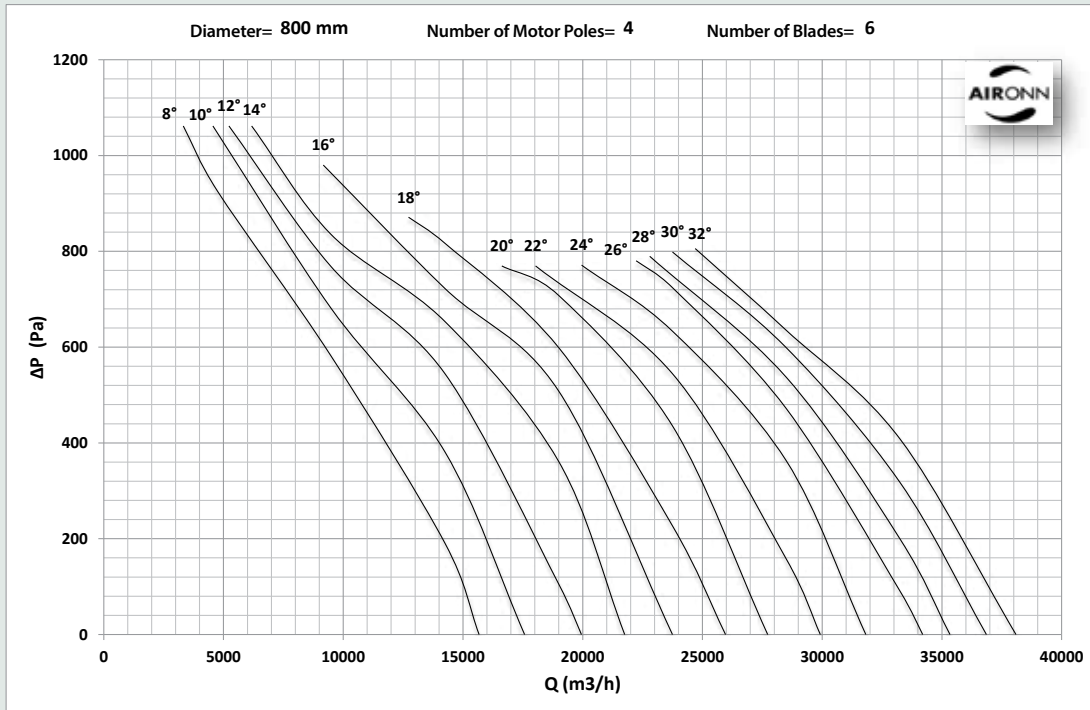

# Series Type Axial Smoke Exhaust Fan Series

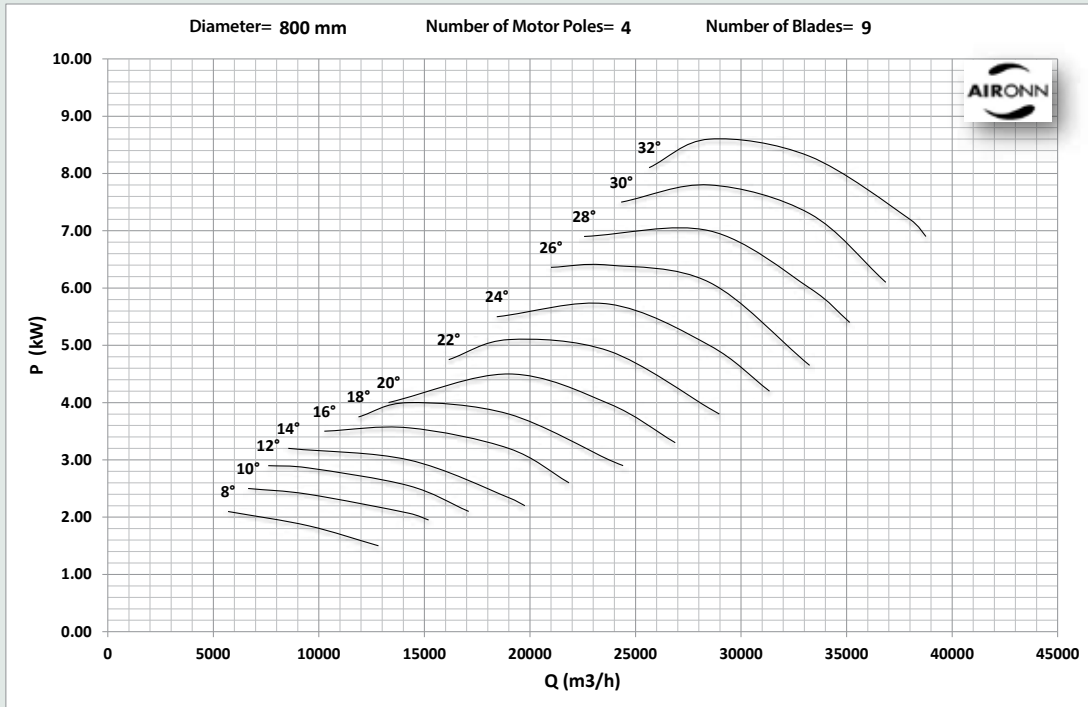
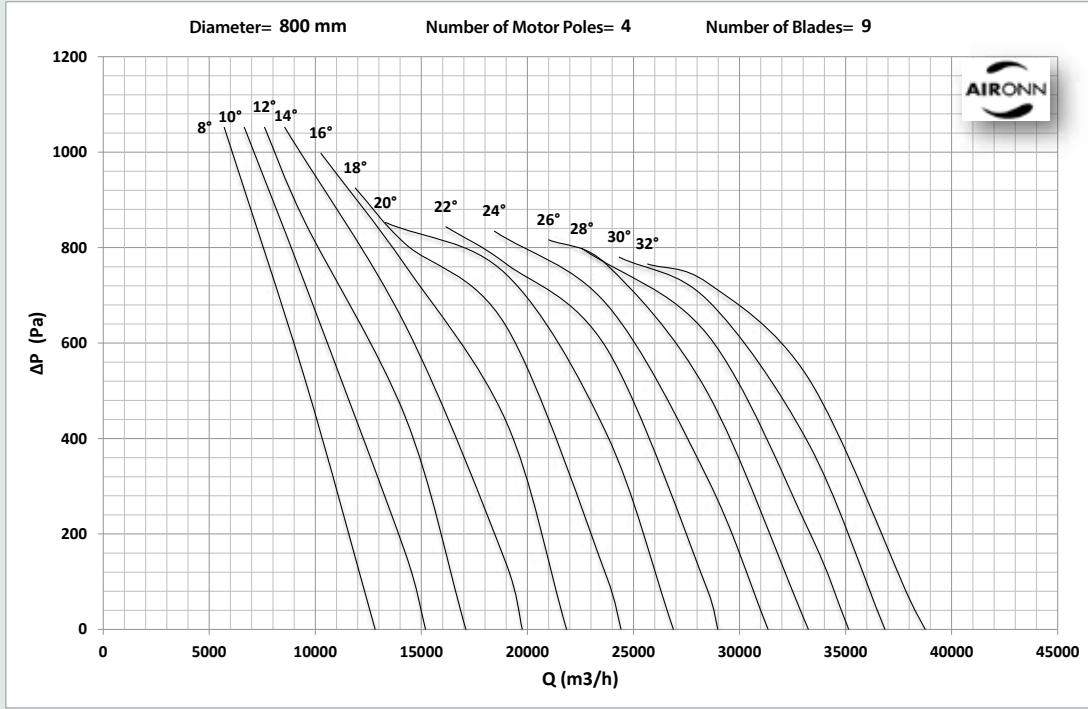

# Series Type Axial Smoke Exhaust Fan Series

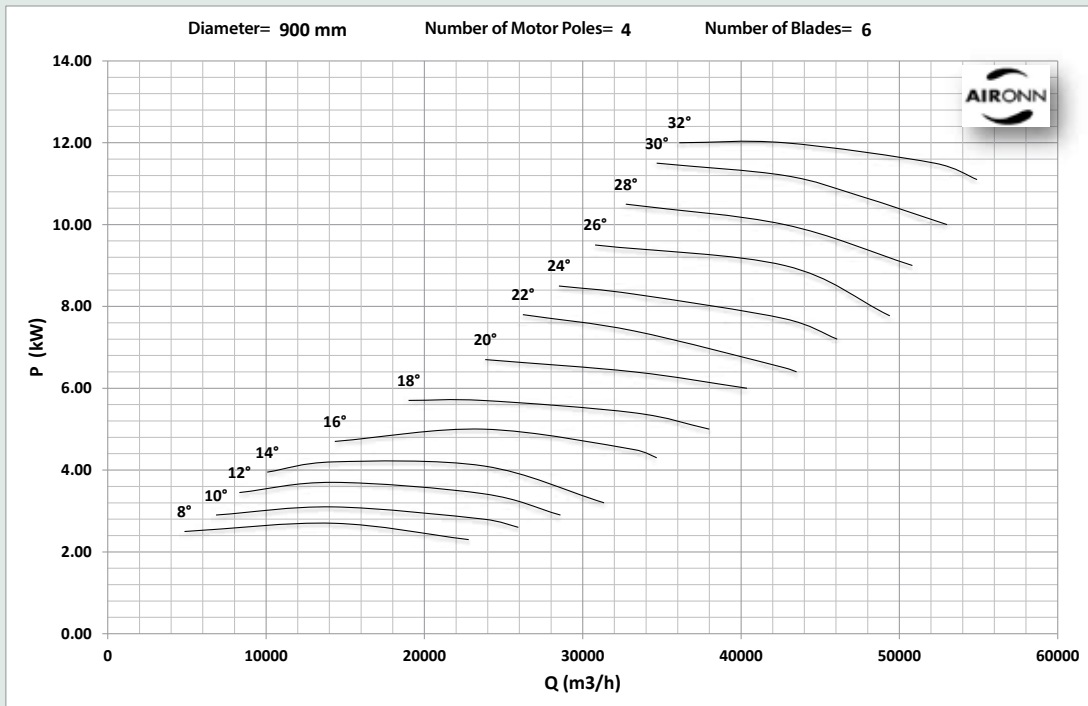
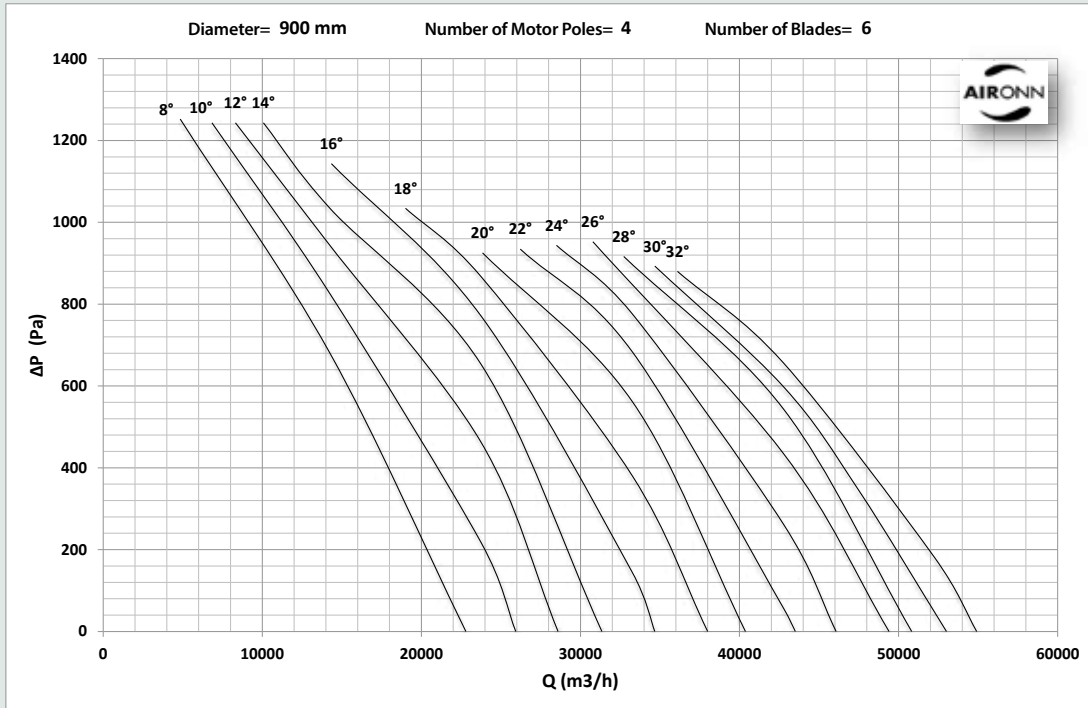

# Series Type Axial Smoke Exhaust Fan Series

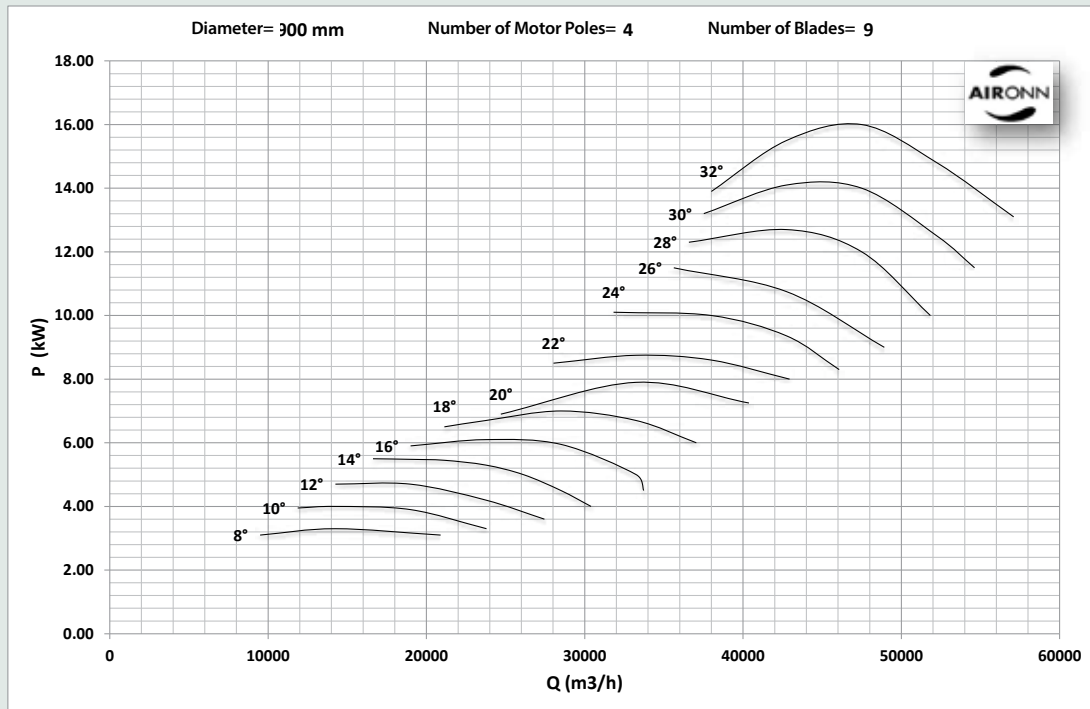
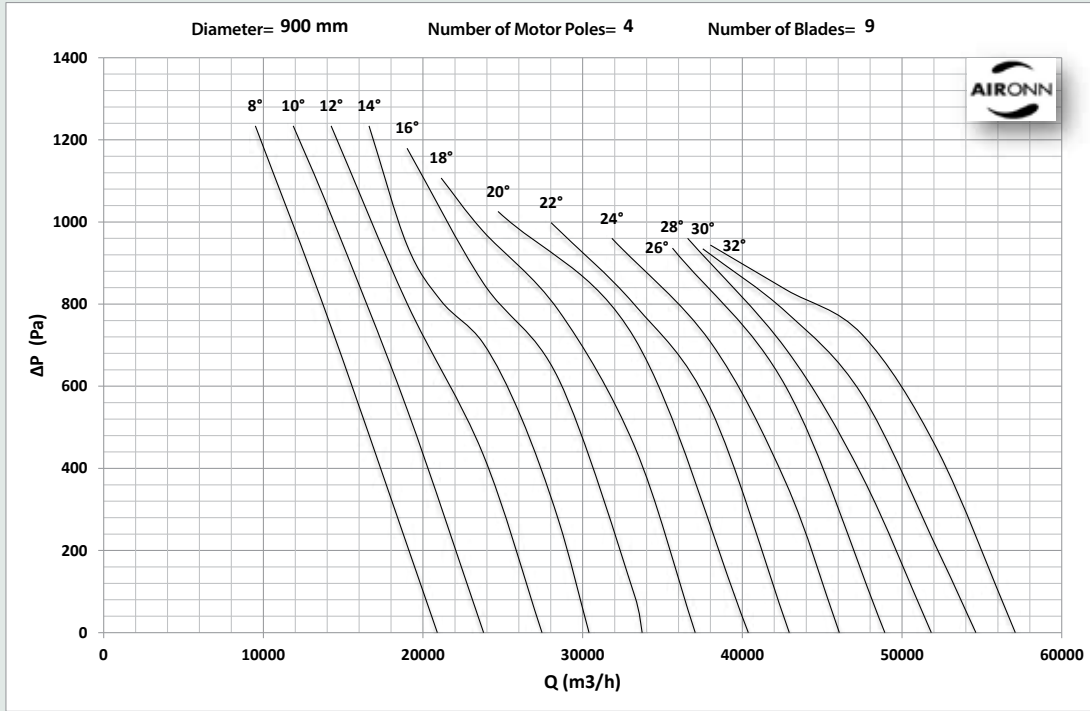

# Series Type Axial Smoke Exhaust Fan Series

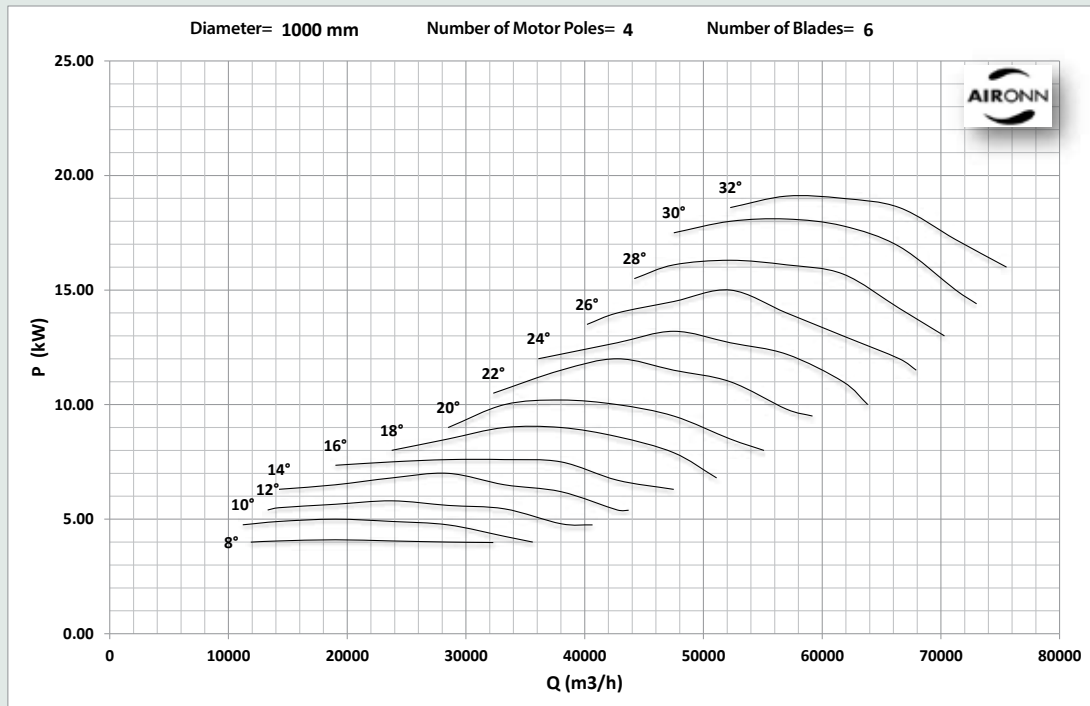
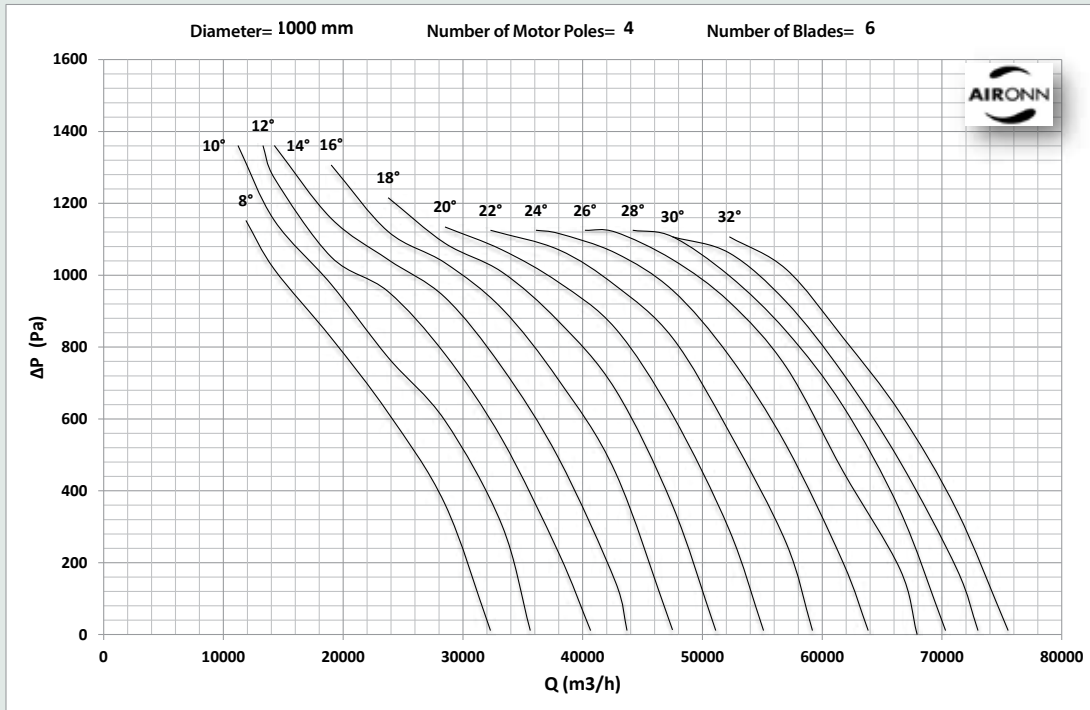



# Series Type Axial Smoke Exhaust Fan Series

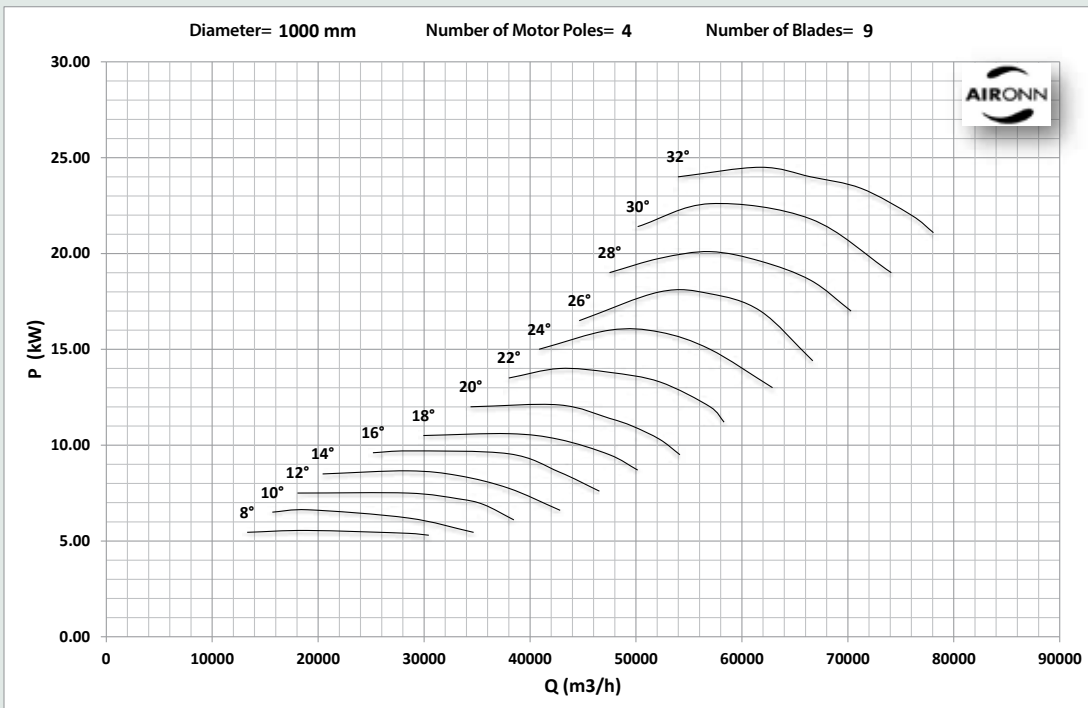
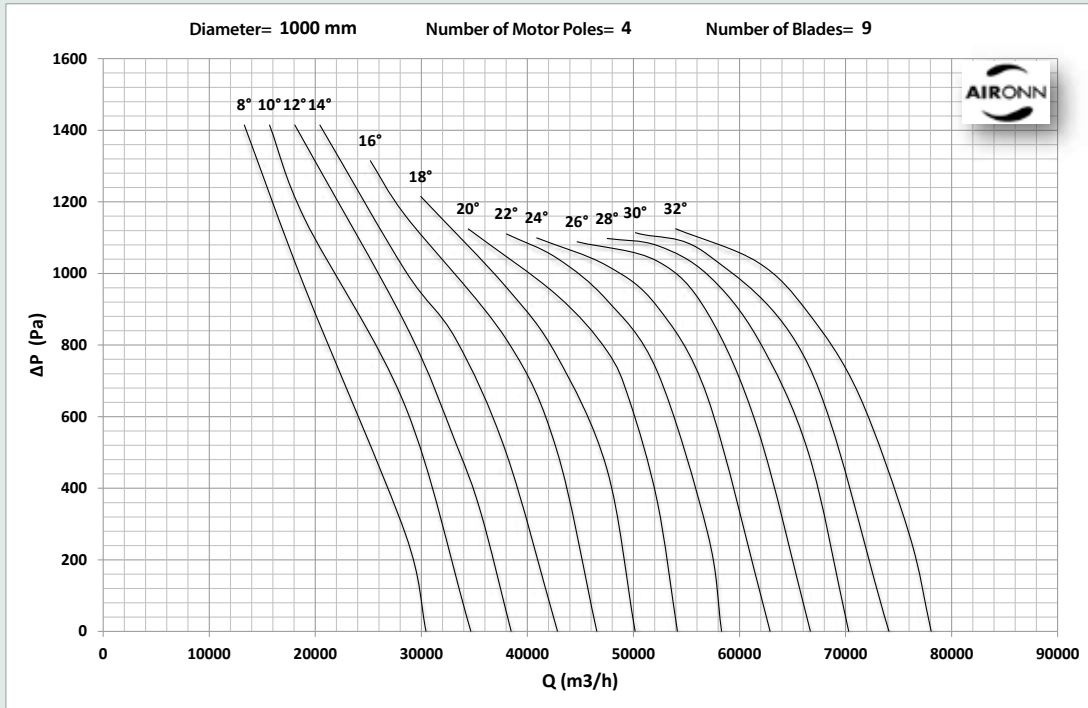

# Series Type Axial Smoke Exhaust Fan Series

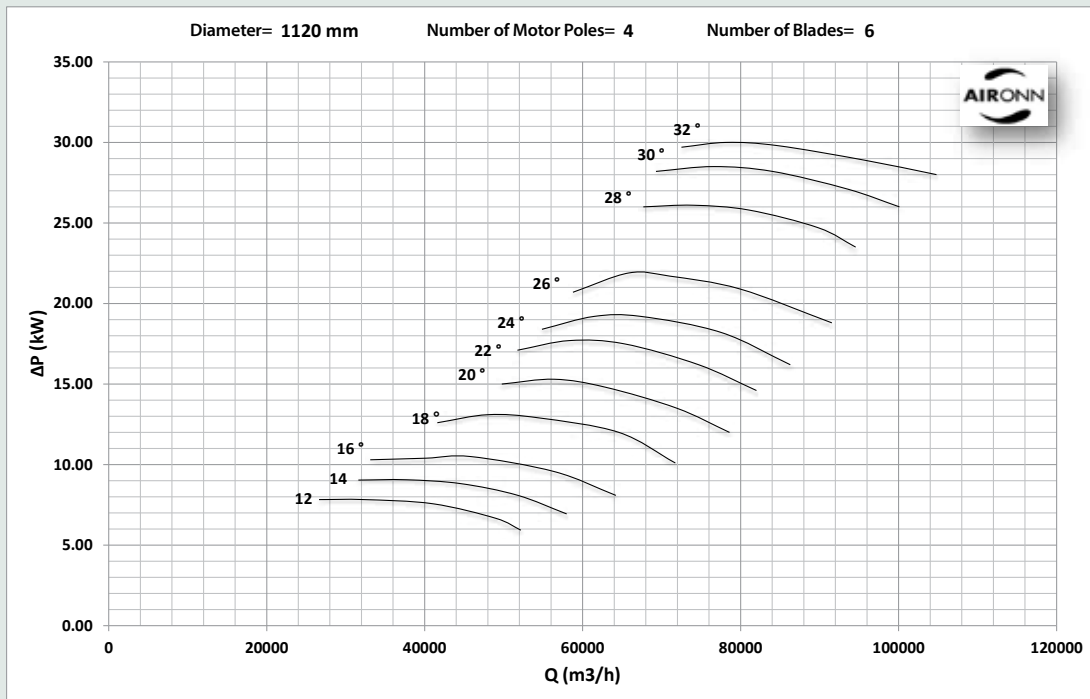
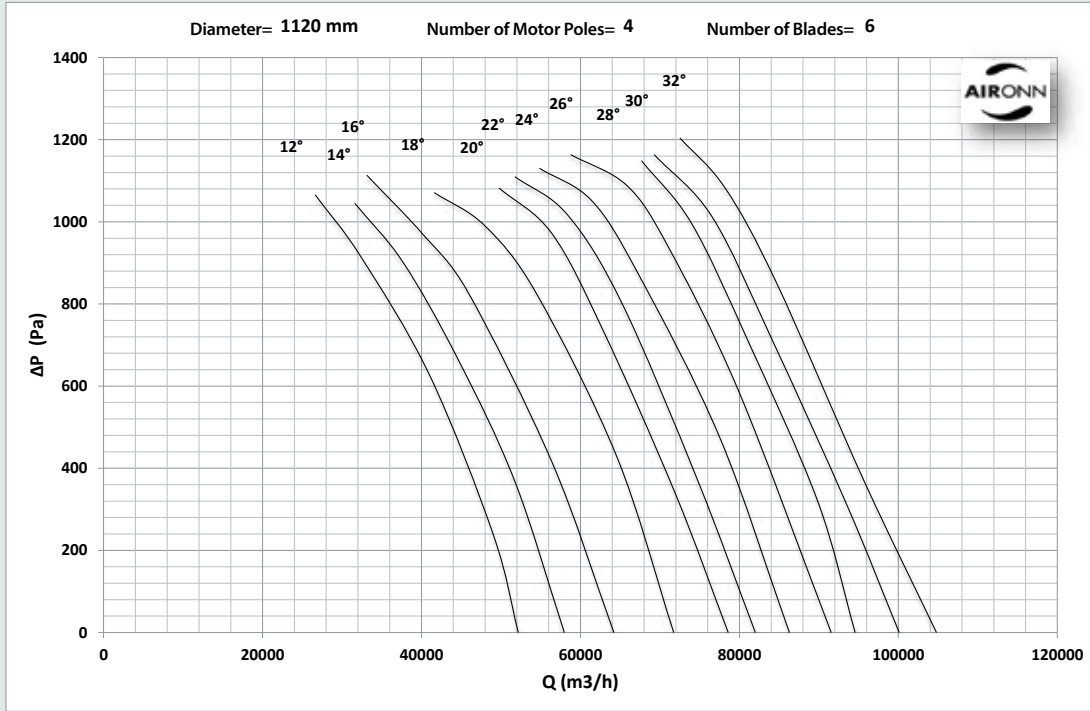

# Series Type Axial Smoke Exhaust Fan Series

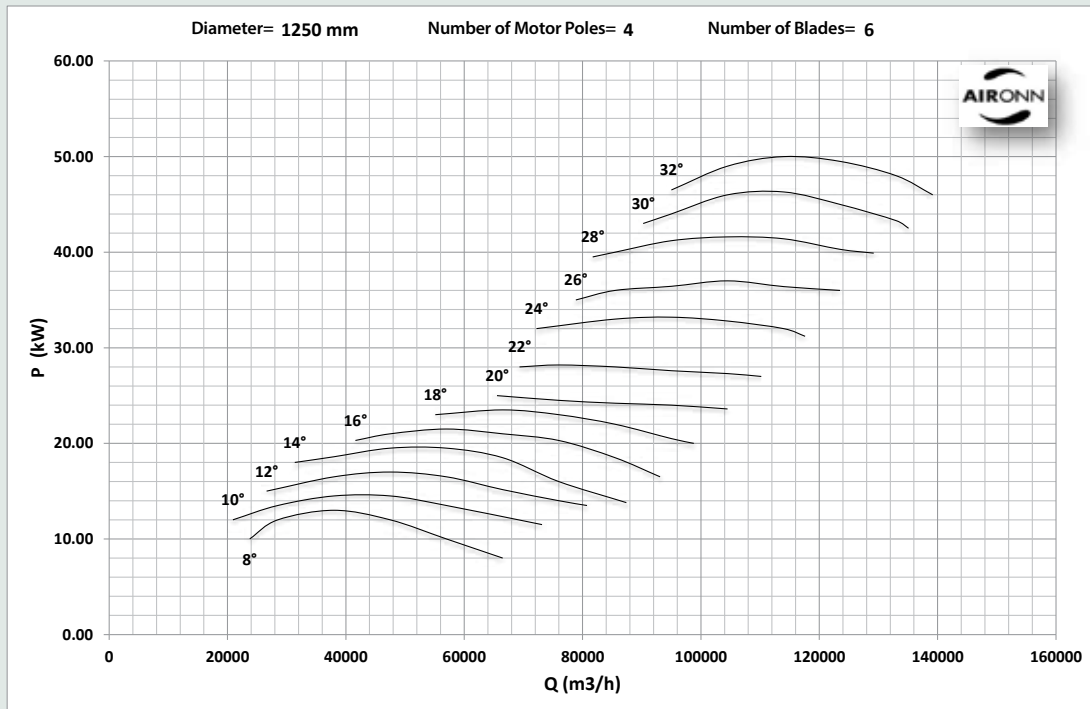
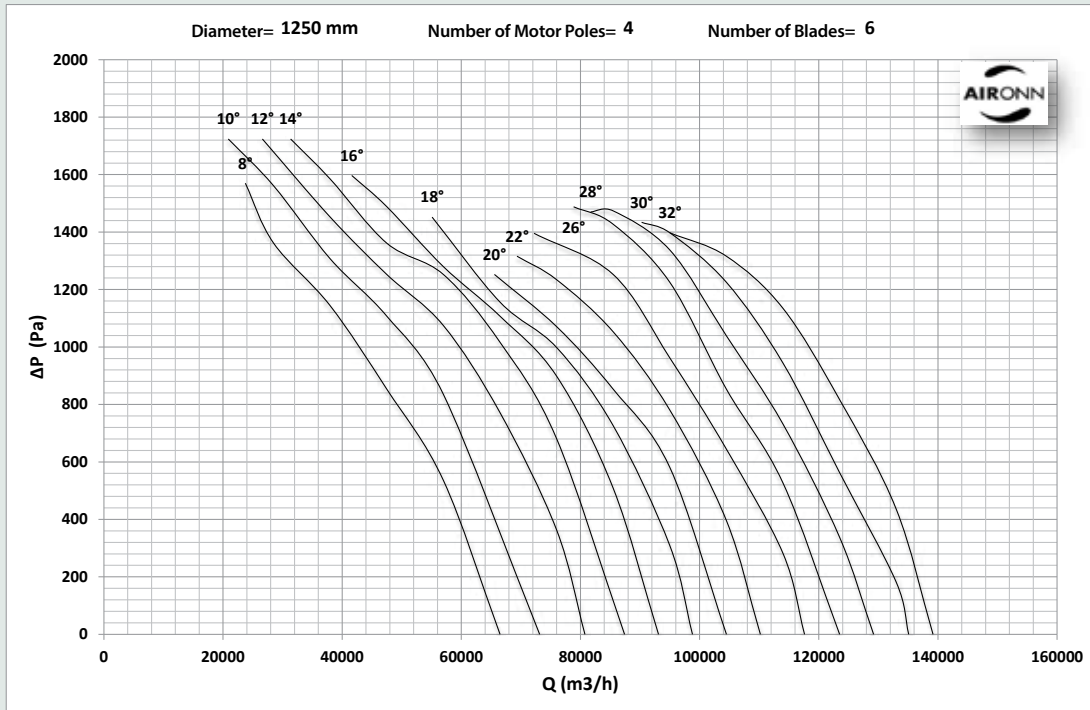

# Series Type Axial Smoke Exhaust Fan Series

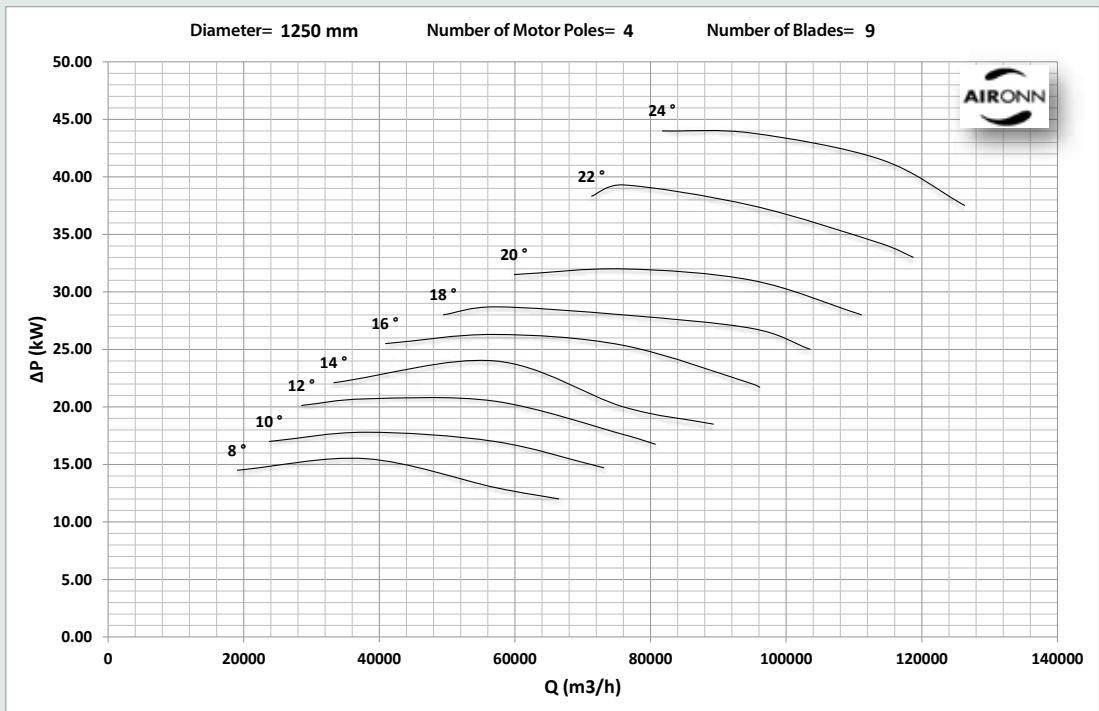
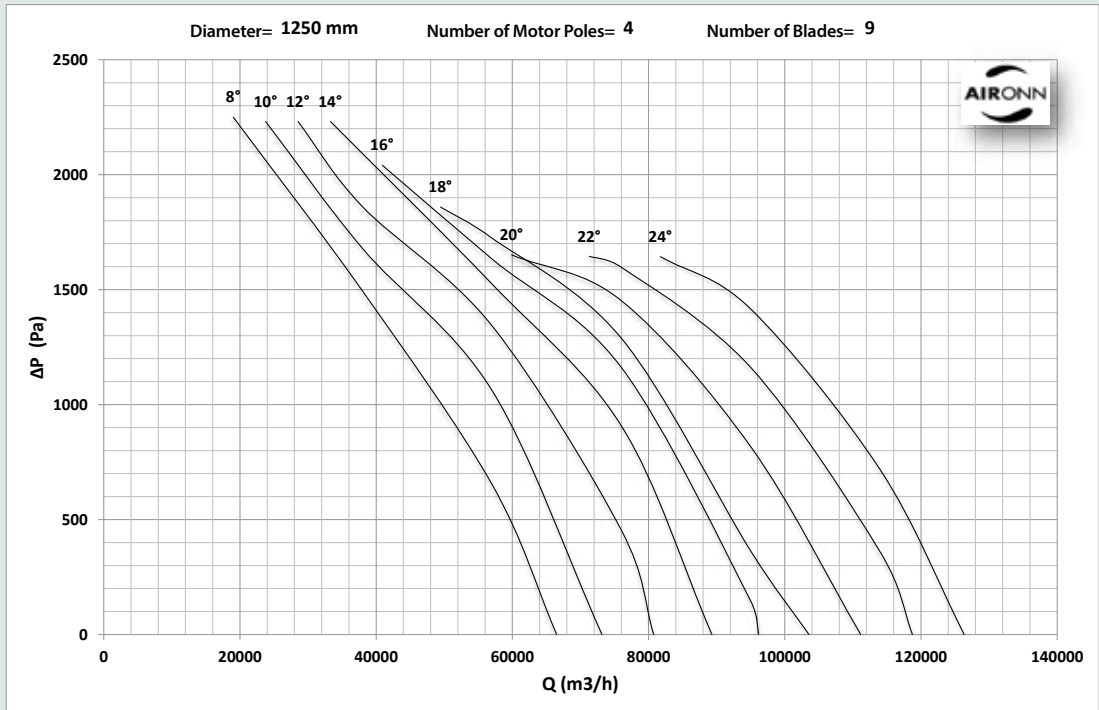



# Twin Spindle Axial Type Smoke Exhaust Fan Series

Fans in the Aironn Two Spindle Axial Type Smoke Exhaust Fan series have 300 ° C-2 hours and 400 ° C-2 hours certificates in compliance with EN 12101-3. Adjustable edge angle of the series in the range of diameters between 400 mm and 1250 mm presents a broad performance range. Twin spindles on the single motor provides high pressure values by using two fan blades. It saves space due to its lengthened body. Performance of the fans in Twin Spindle Axial Type Smoke Exhaust Fan Series have been tested in accordance with AMCA 210-07 standard.

## Fan Body

The body of the fans is made of high quality and corrosion resistant hot-dip galvanize coated sheet metal. The fan flanges are manufactured by bending the body so they are self flanged. Standard production is long-bodied. Body inspection hatch is optional.

## Fan Blades

Aerodynamic fan blades are made of ETIAL 171 with injection moulding method. They are statically and dynamically balanced in compliance with ISO 1940/1-2003.

## Motor

They have 2 IP 55 motors with class H insulation available in single cycle or double cycle options. If requested, single cycle motors can be used with inverters.

## Electricity

IP 55 electric terminal box made of aluminium is standard.

## Accessories

Horizontal Mount Foot, Vertical Mount Foot, Silencer (50), Silencer (100), Silencer with Pod (100), Counter Flange, Protection Grill, Back Draft Damper, Spring Insulator, Inlet Cone, Flexible Coupling, Pacco (Package) Switch, Vibration Sensor, Inverter



# Twin Spindle Axial Type Fresh Air Fan Series

Fans in Aironn Twin Spindle Axial Type Fresh Air Fan Series are suitable to operate at maximum 55 °C. Adjustable edge angle of the series in the range of diameters between 400 mm and 1250 mm presents a broad performance range. Twin spindles on the single motor provides high pressure values by using two fan blades. It saves space due to its lengthened body. Performance of the fans in Twin Spindle Axial Type Fresh Air Fan Series have been tested in accordance with AMCA 210-07 standard.

## Fan Body

The body of the fans is made of high quality and corrosion resistant hot-dip galvanize coated sheet metal. The fan flanges are manufactured by bending the body so they are self flanged. Standard production is long-bodied. Body inspection hatch is optional.

## Fan Blades

Aerodynamic fan blades are made of ETIAL 171 with injection moulding method. They are statically and dynamically balanced in compliance with ISO 1940/1-2003.

## Motor

They have 2 IP 55 motors with class F insulation available in single cycle or double cycle options. If requested, single cycle motors can be used with inverters.

## Electricity

IP 55 electric terminal box made of plastic is standard.

## Accessories

Horizontal Mount Foot, Vertical Mount Foot, Silencer (50), Silencer (100), Silencer with Pod (100), Counter Flange, Back Draft Damper, Protection Grill, Spring Insulator, Inlet Cone, Flexible Coupling, Pacco (Package) Switch, Vibration Sensor, Inverter



## Twin Spindle Axial Type Smoke Exhaust & Fresh Air Fan Series

### Dimensions

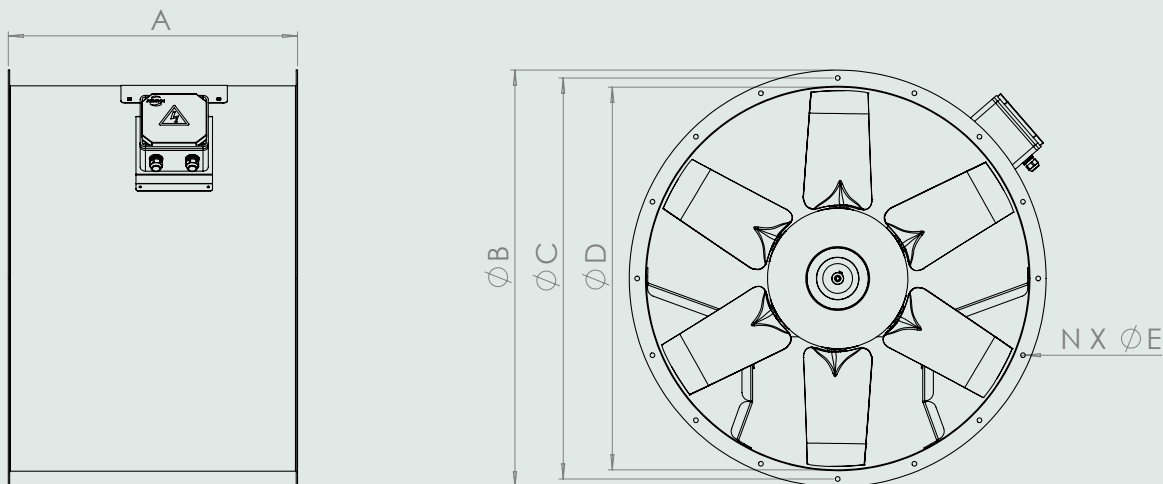

	A	B	C	D	F	G	L	H	N X ØE	ØK
400	550	460	430	400	300	360	508	500	8 x 11	11
450	550	510	484	450	320	400	508	550	8 x 11	11
500	550	560	537	500	370	450	508	600	8 x 11	11
560	600	620	597	560	420	500	558	670	8 x 11	11
630	700	590	667	630	460	540	658	790	8 x 11	11
710	750	770	747	710	500	600	708	870	8 x 11	11
800	850	880	844	800	580	680	808	970	16 x 11	11
900	900	980	944	900	660	760	844	1070	16 x 13	13
1000	1000	1080	1044	1000	750	850	942	1167	16 x 13	13
1250	1250	1330	1294	1250	960	1060	1192	1417	16 x 13	13



## Twin Spindle Axial Type Fresh Air Fan Series

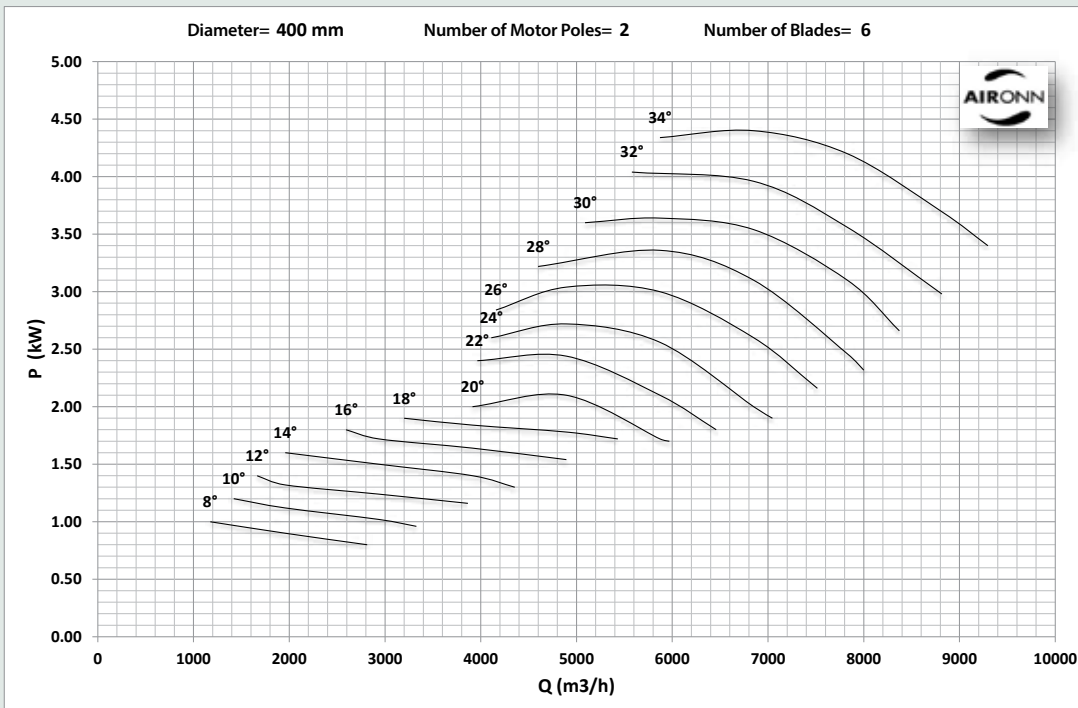
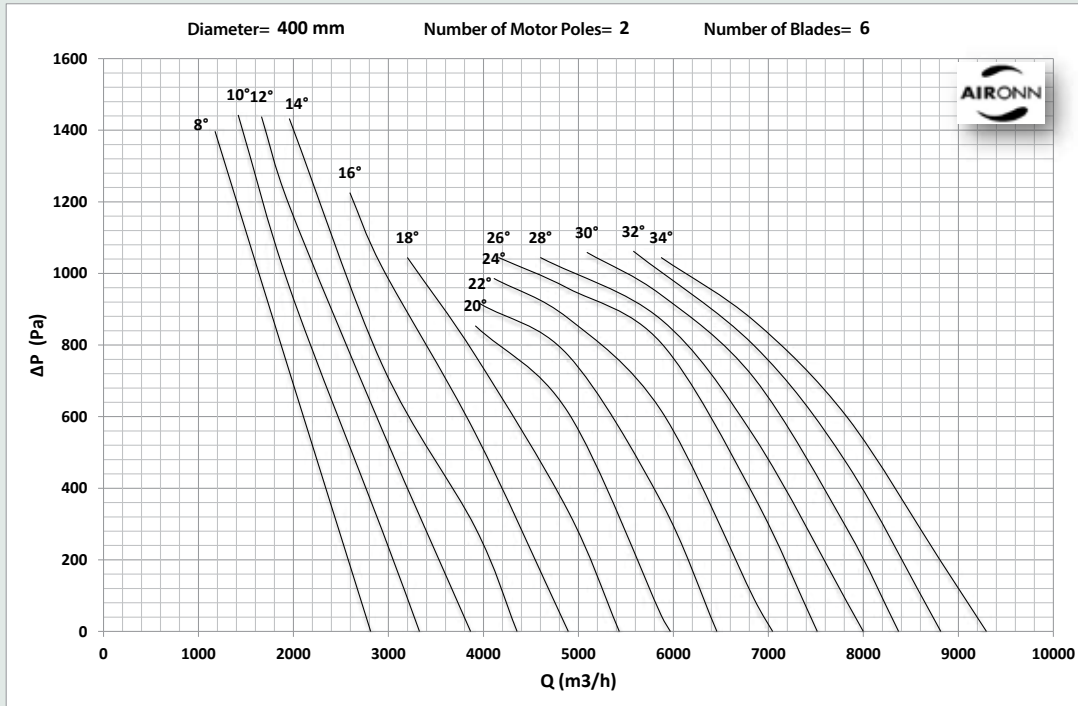

## Twin Spindle Axial Type Fresh Air Fan Series

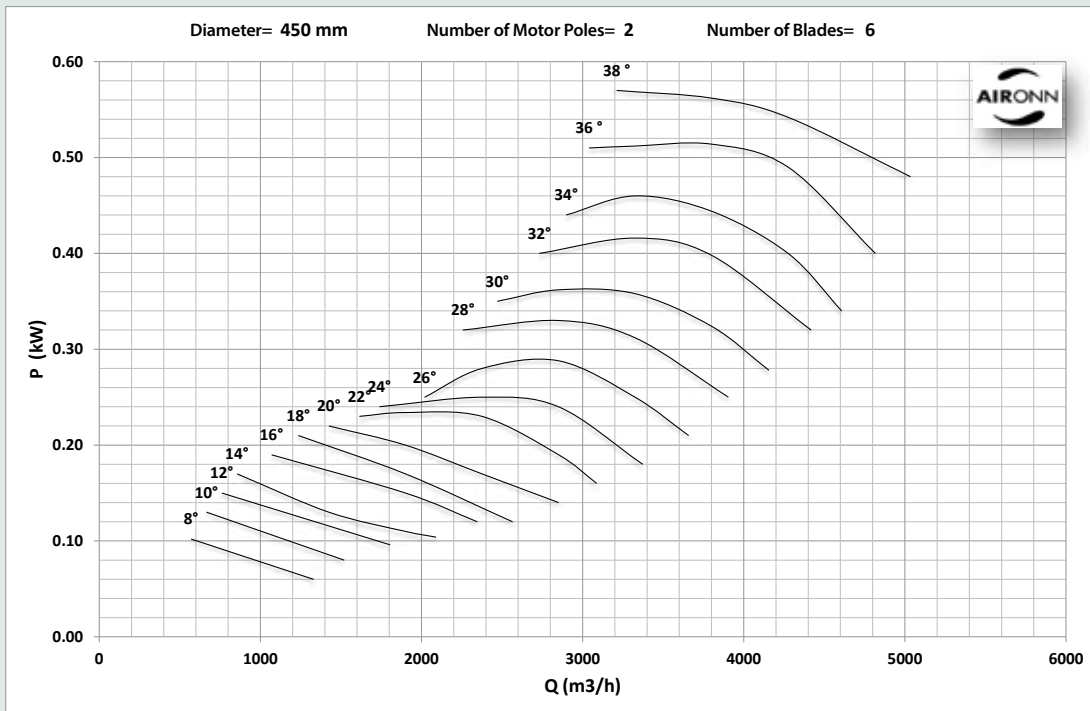
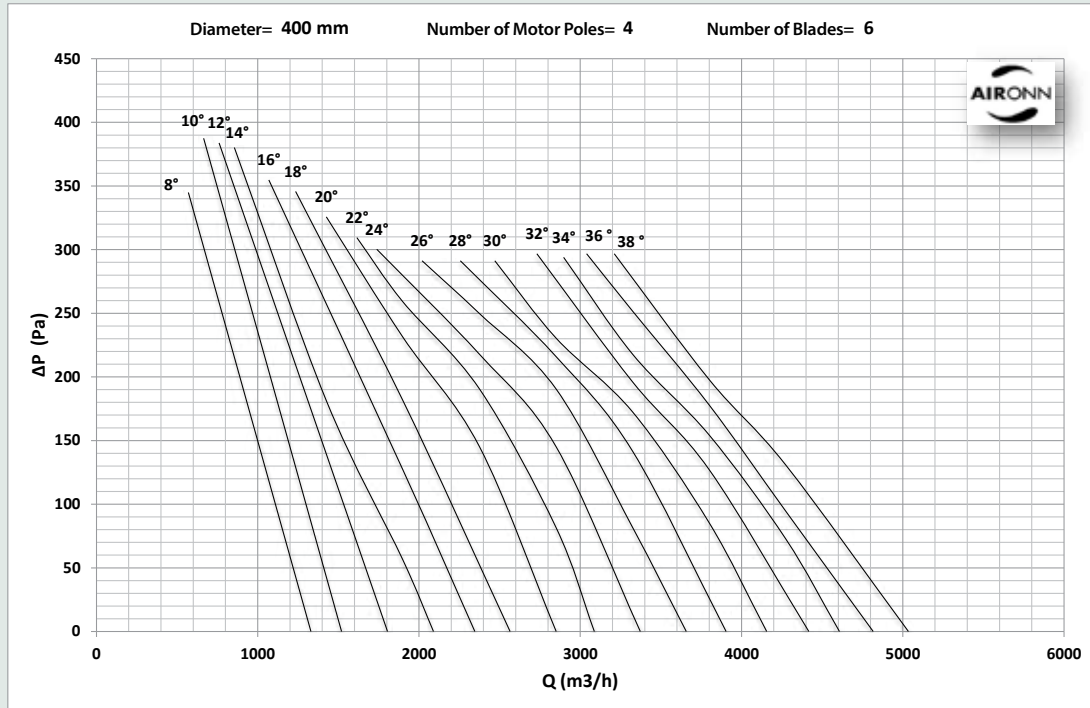

## Twin Spindle Axial Type Fresh Air Fan Series

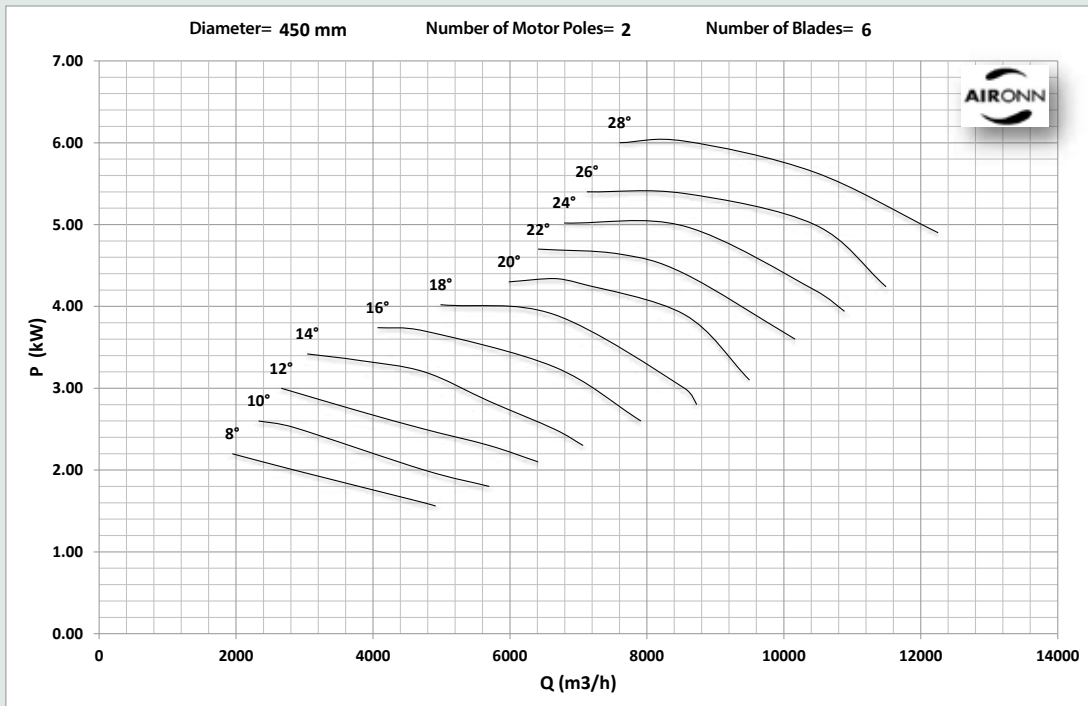
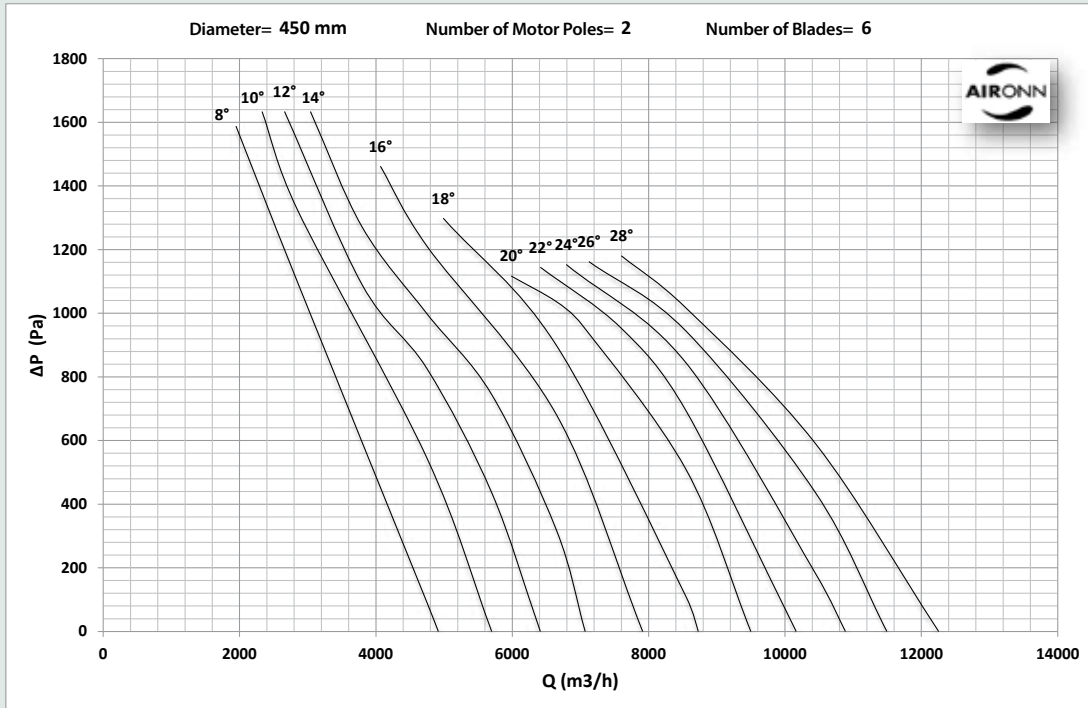

## Twin Spindle Axial Type Fresh Air Fan Series

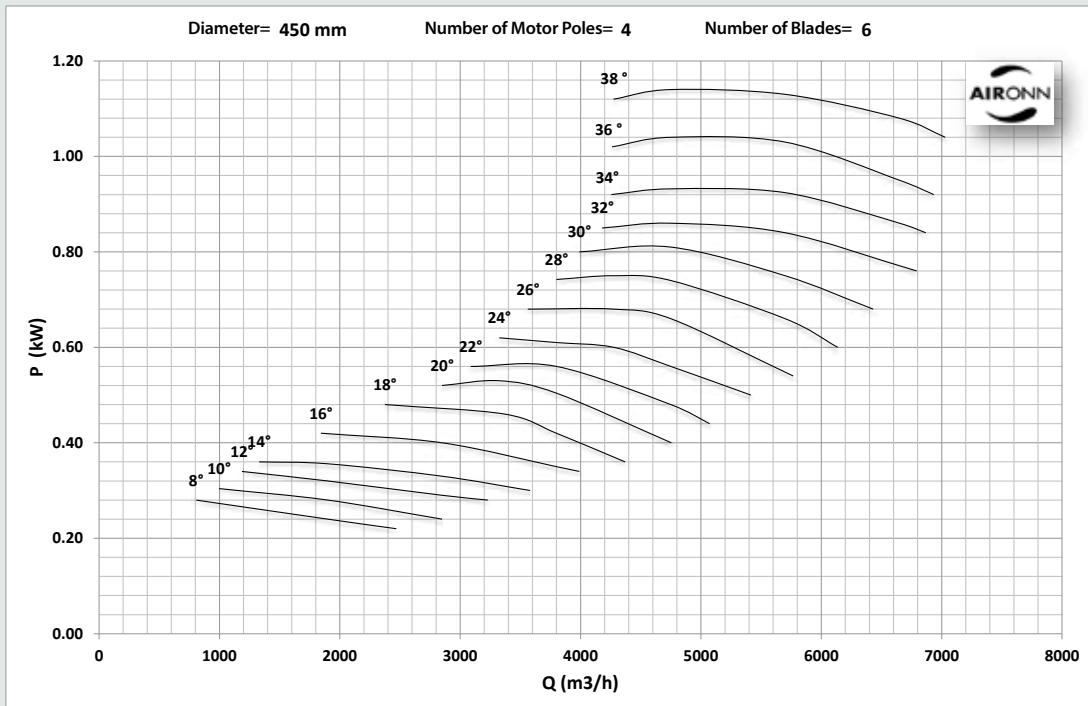
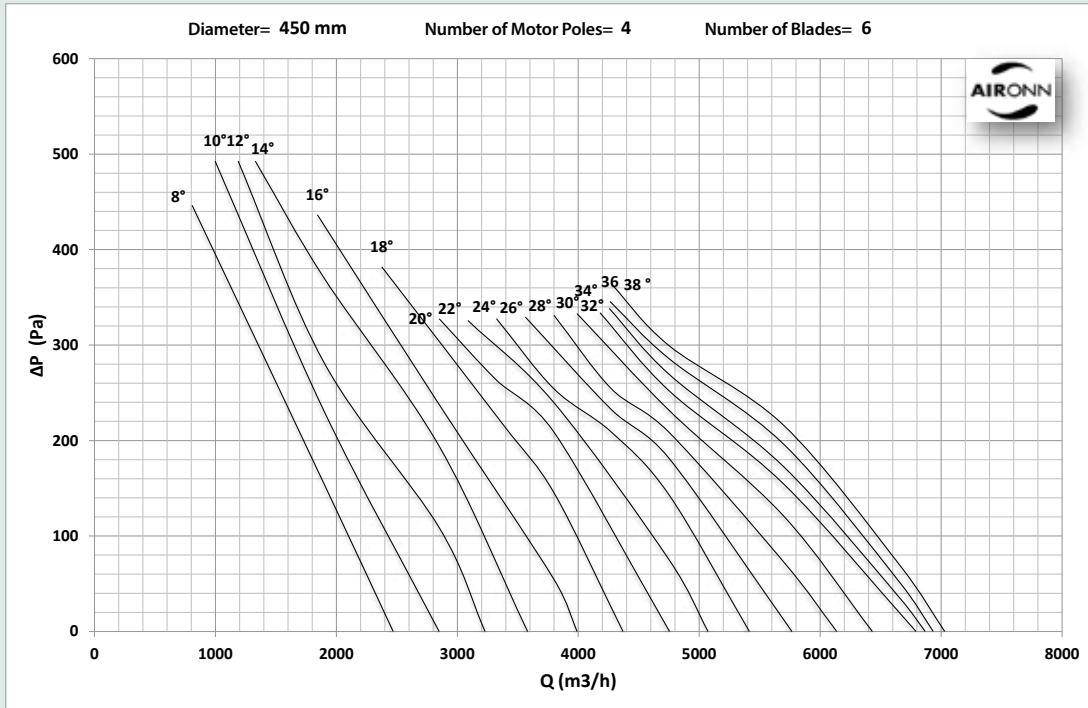

## Twin Spindle Axial Type Fresh Air Fan Series

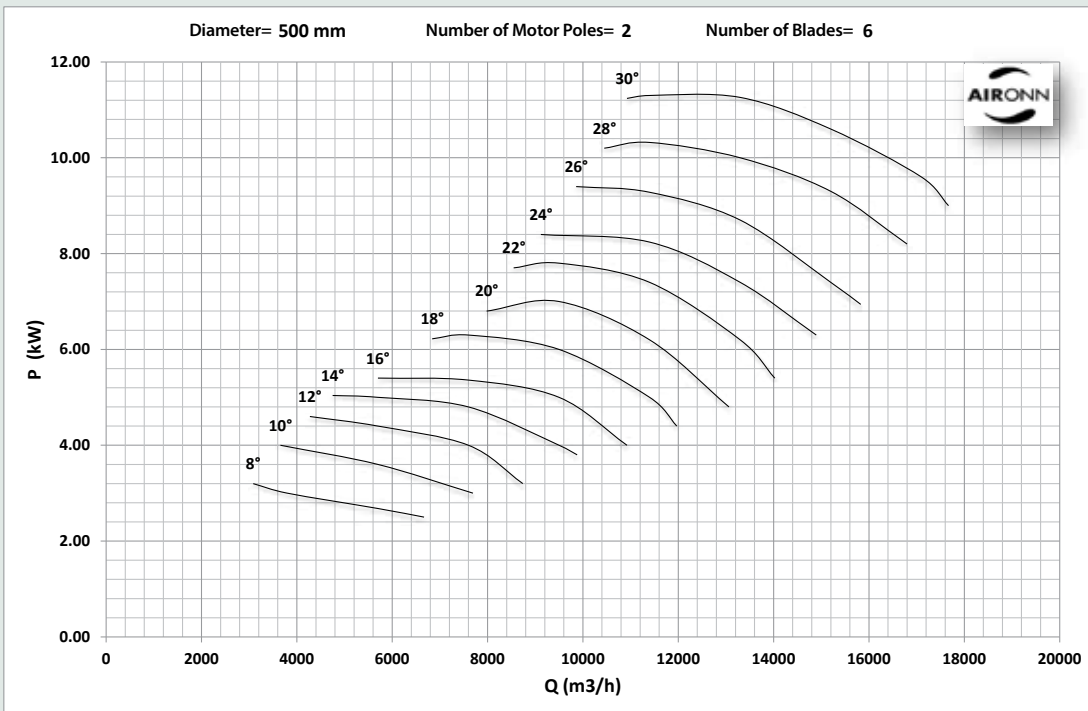
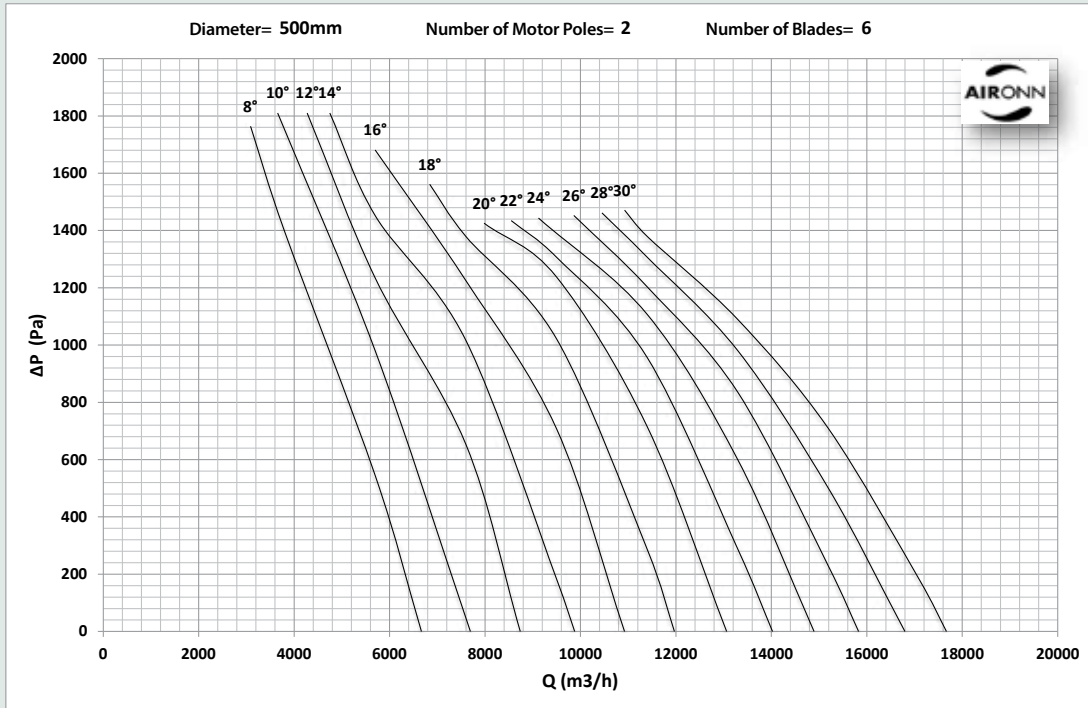

## Twin Spindle Axial Type Fresh Air Fan Series

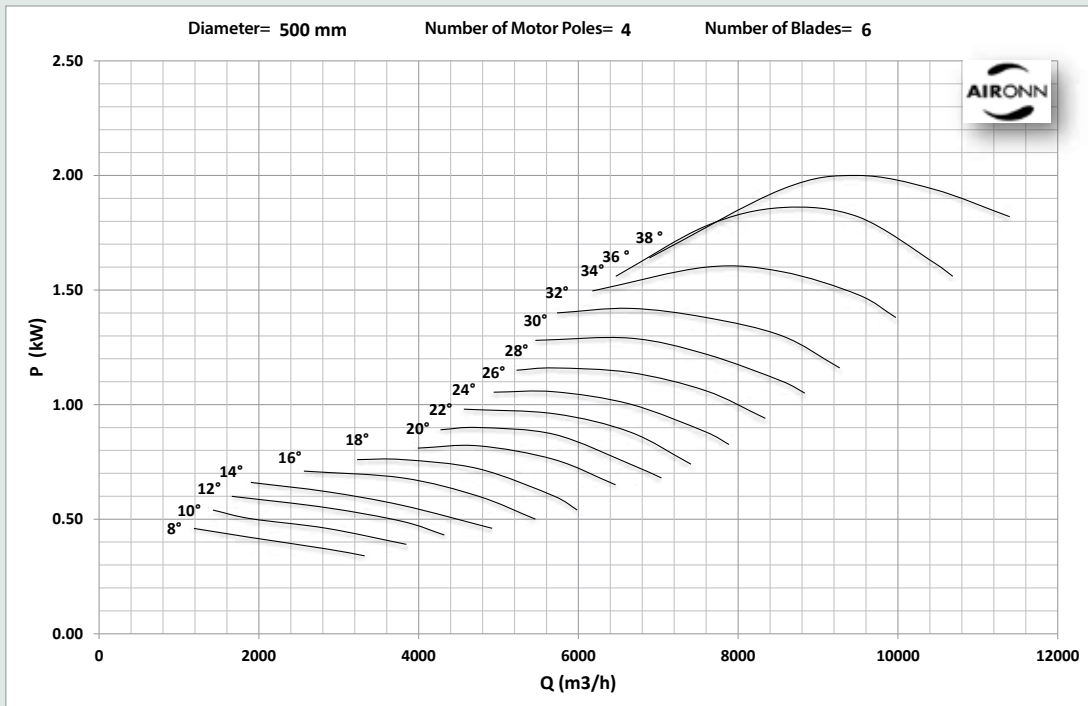
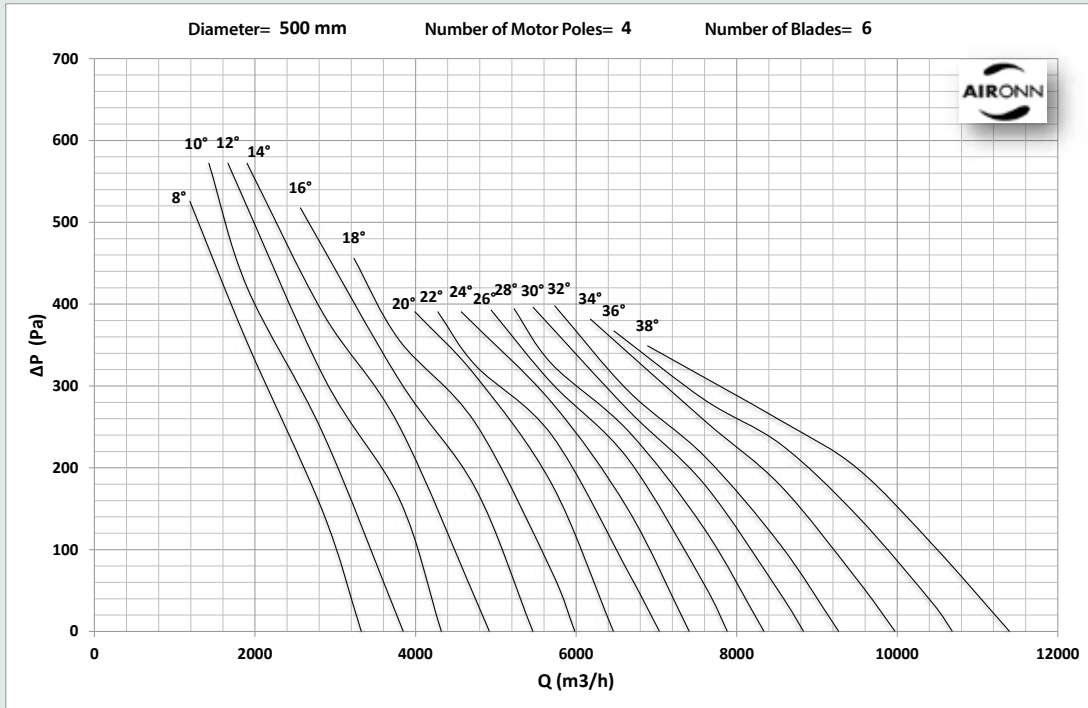

## Twin Spindle Axial Type Fresh Air Fan Series

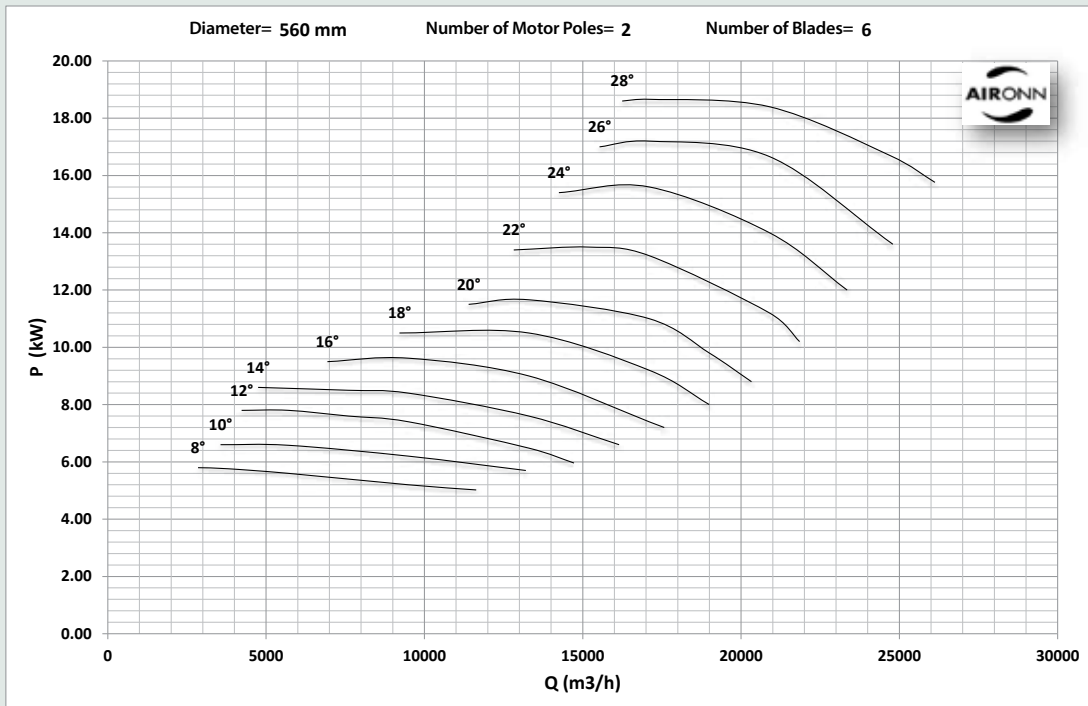
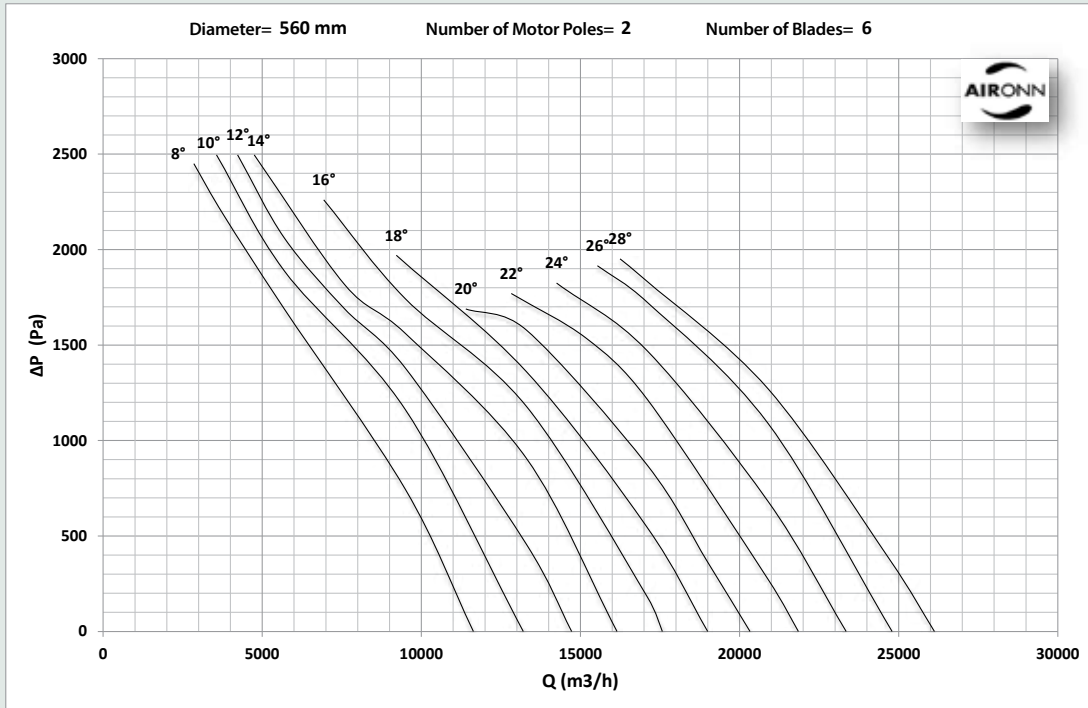

## Twin Spindle Axial Type Fresh Air Fan Series

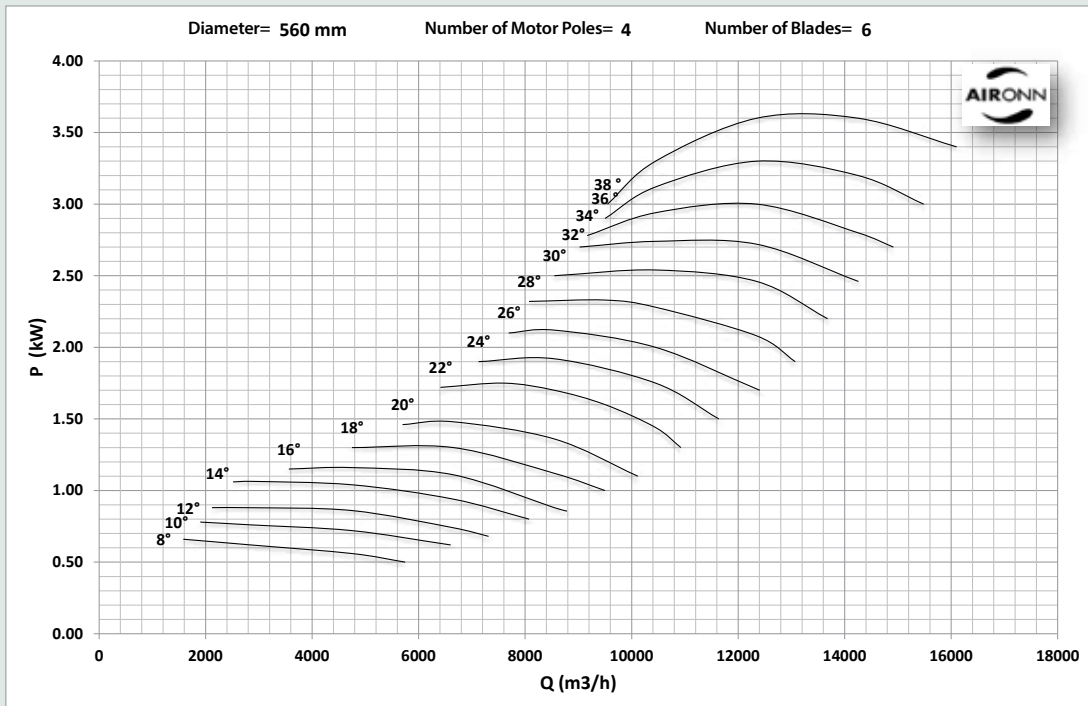
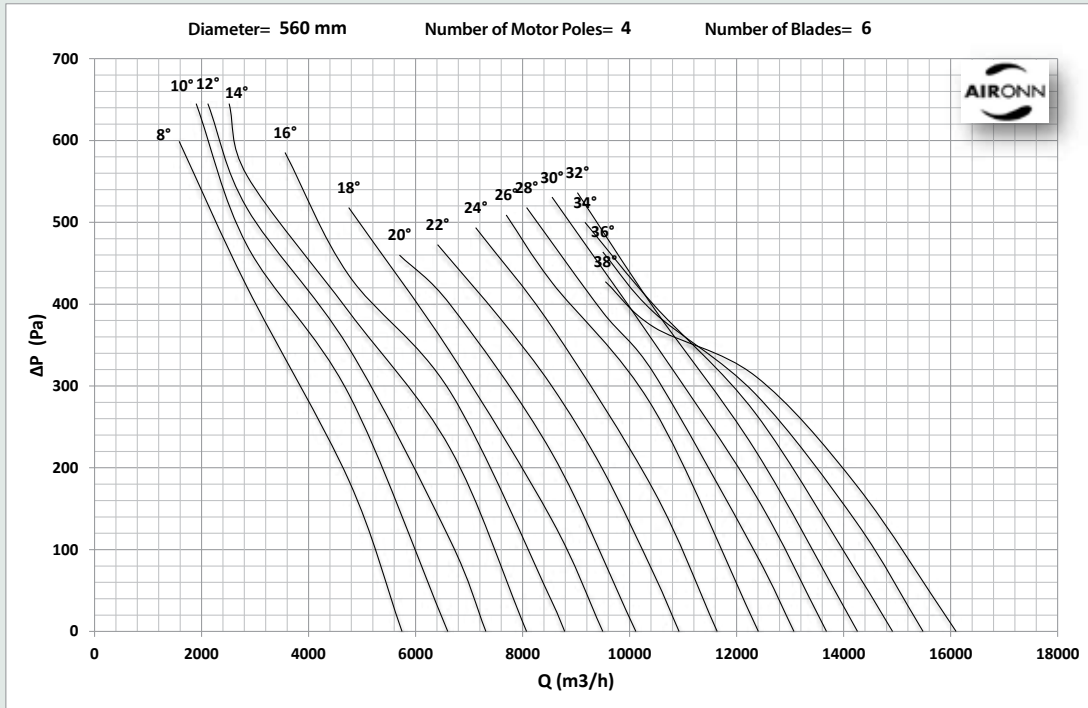



## Twin Spindle Axial Type Fresh Air Fan Series

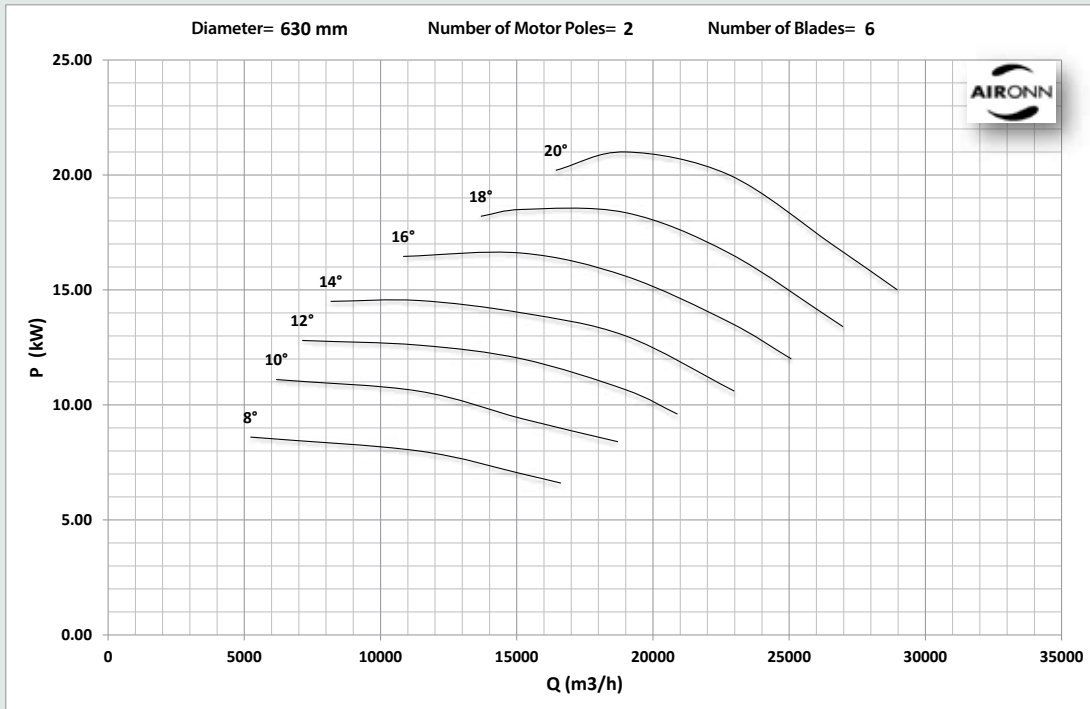
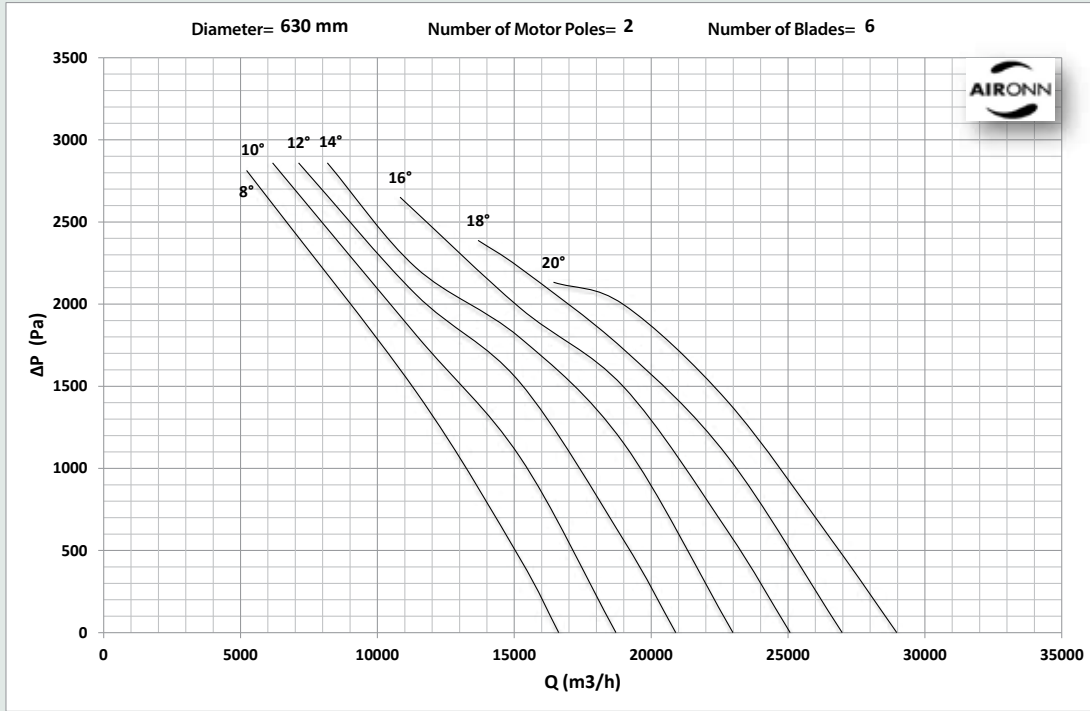

## Twin Spindle Axial Type Fresh Air Fan Series

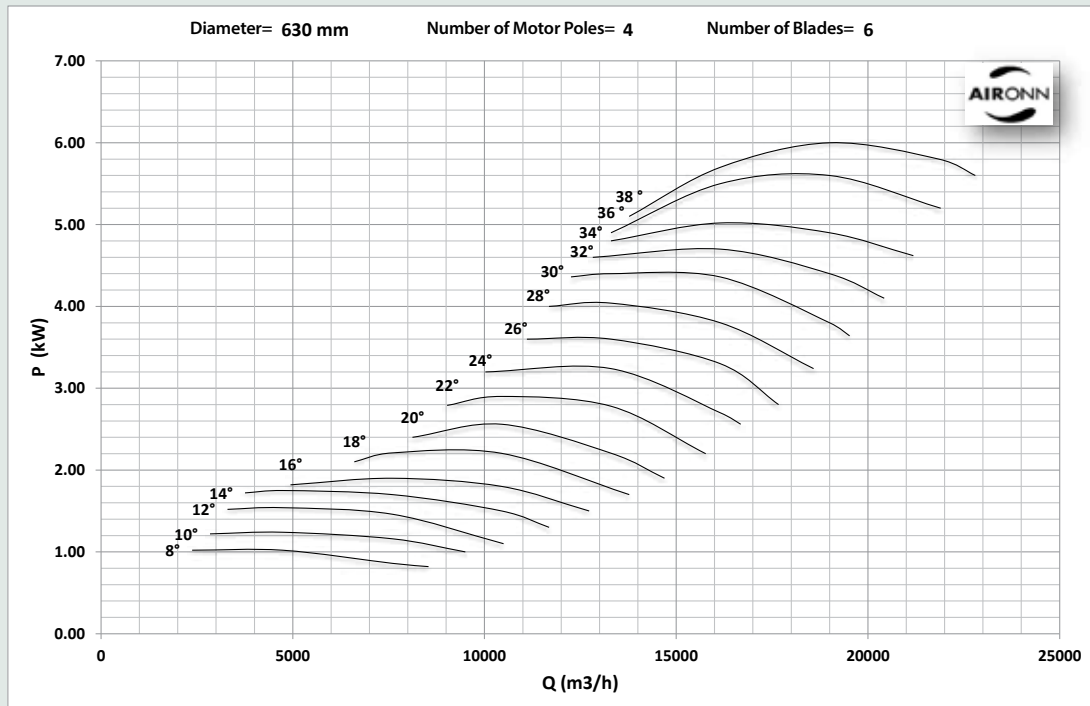
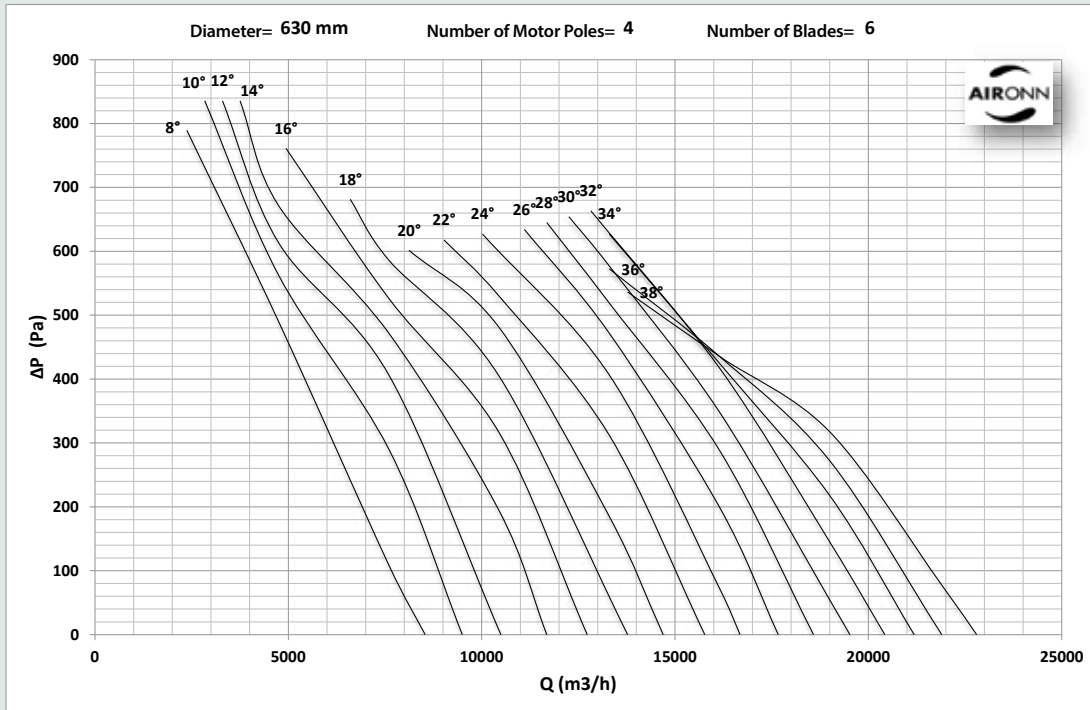

## Twin Spindle Axial Type Fresh Air Fan Series

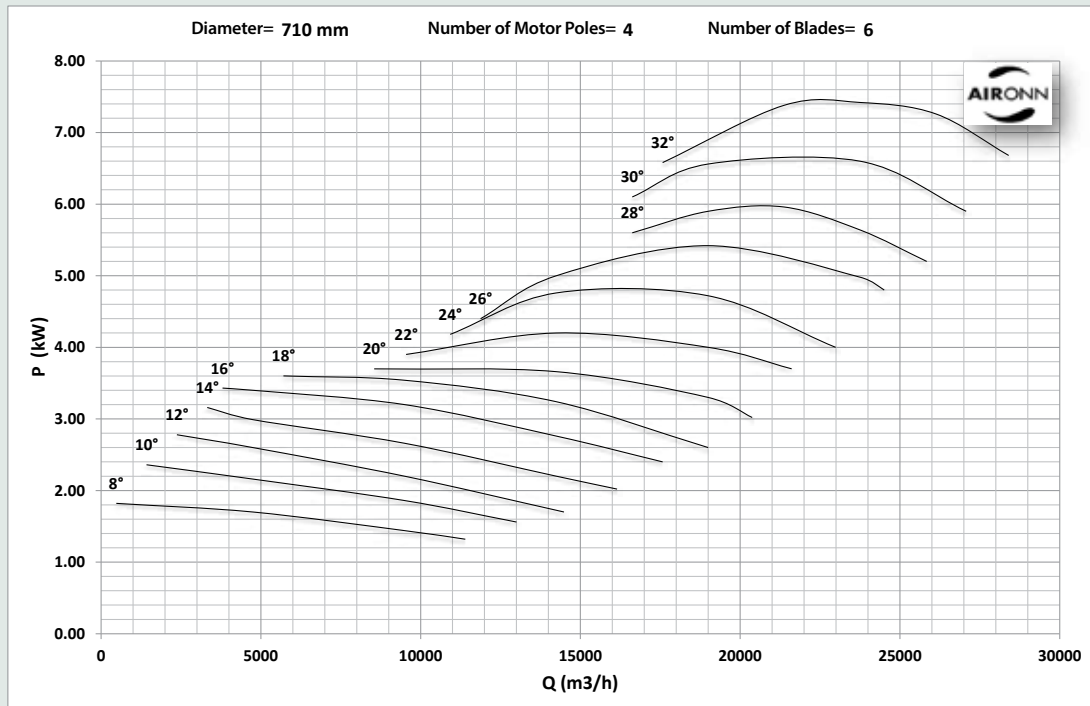
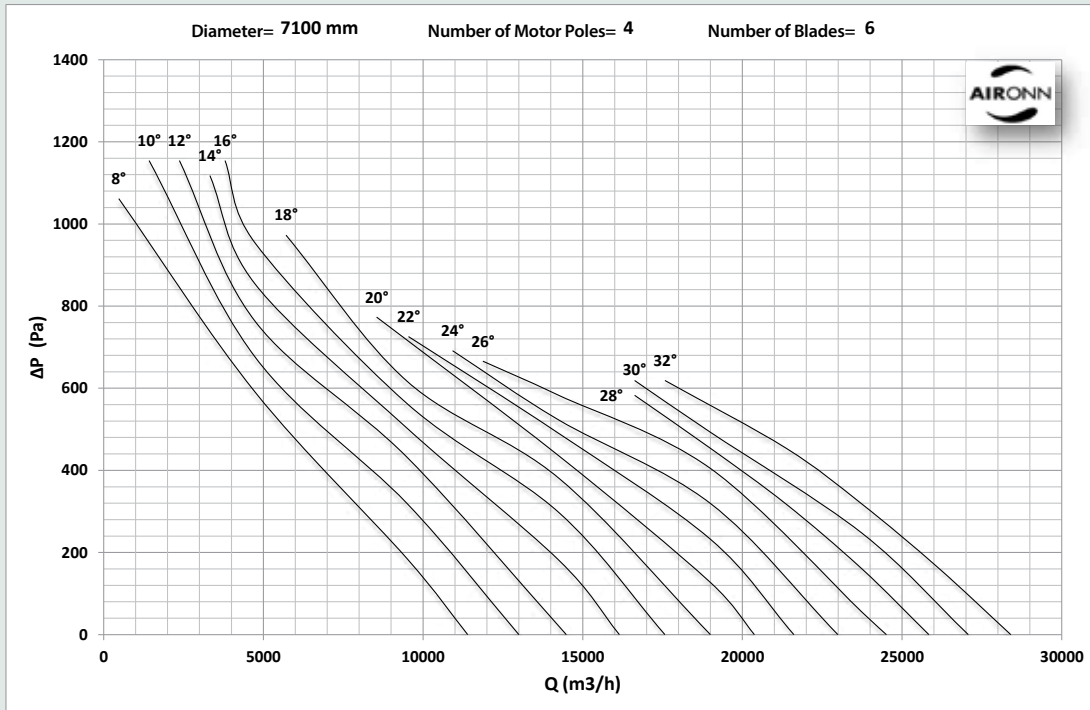

## Twin Spindle Axial Type Fresh Air Fan Series

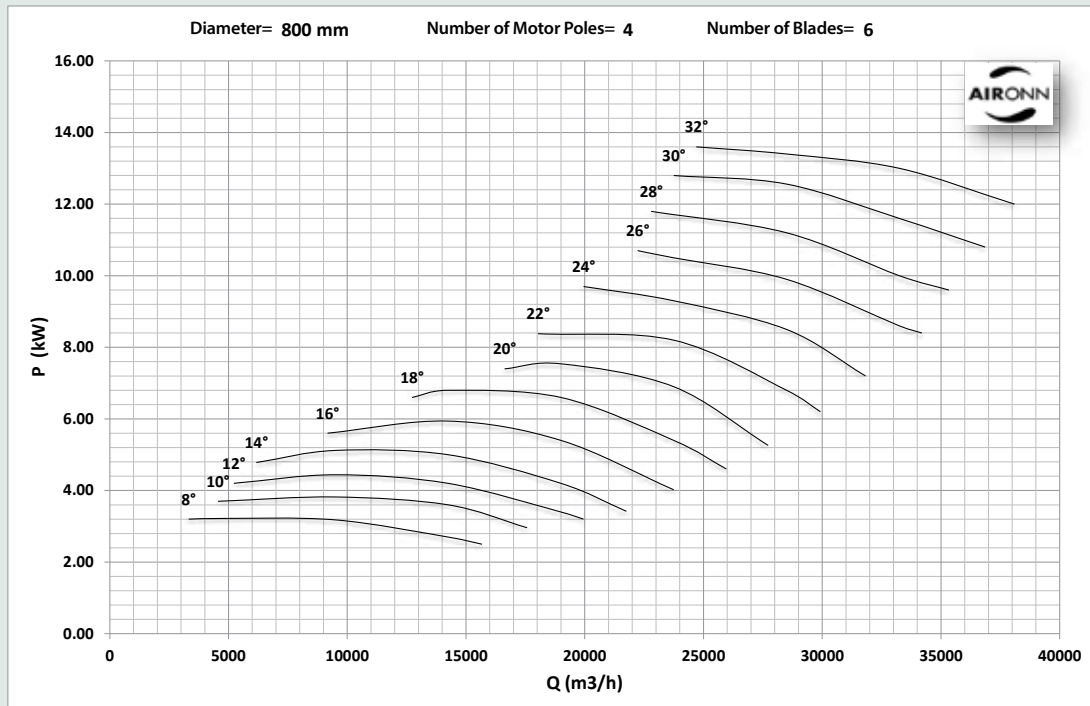
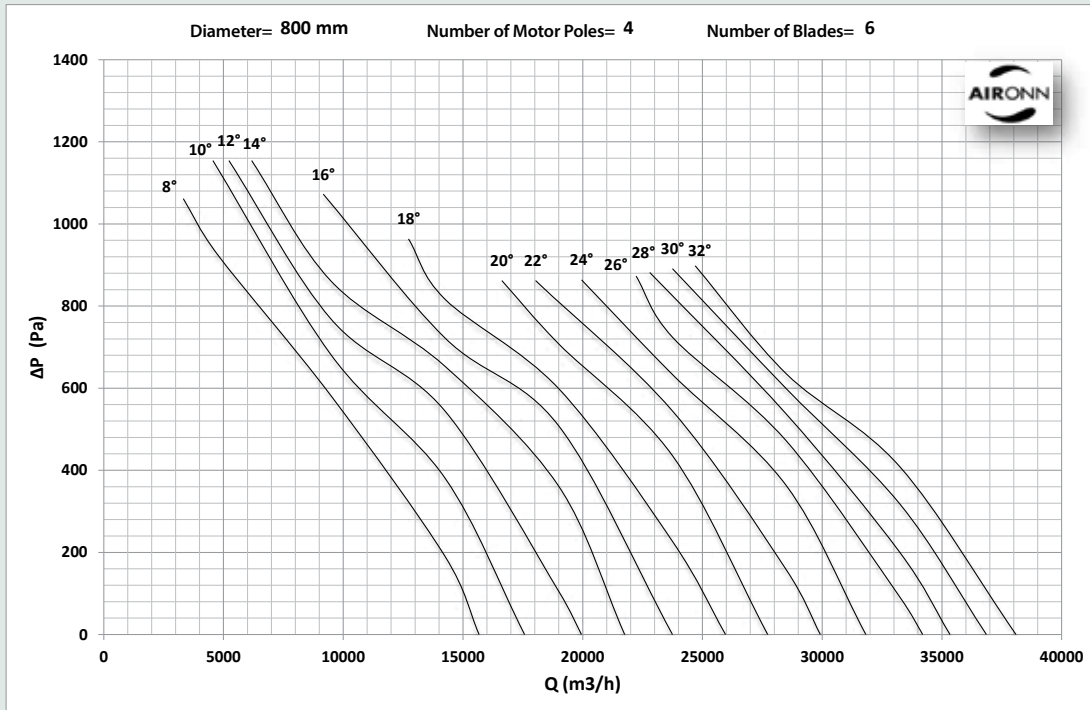

# Twin Spindle Axial Type Fresh Air Fan Series

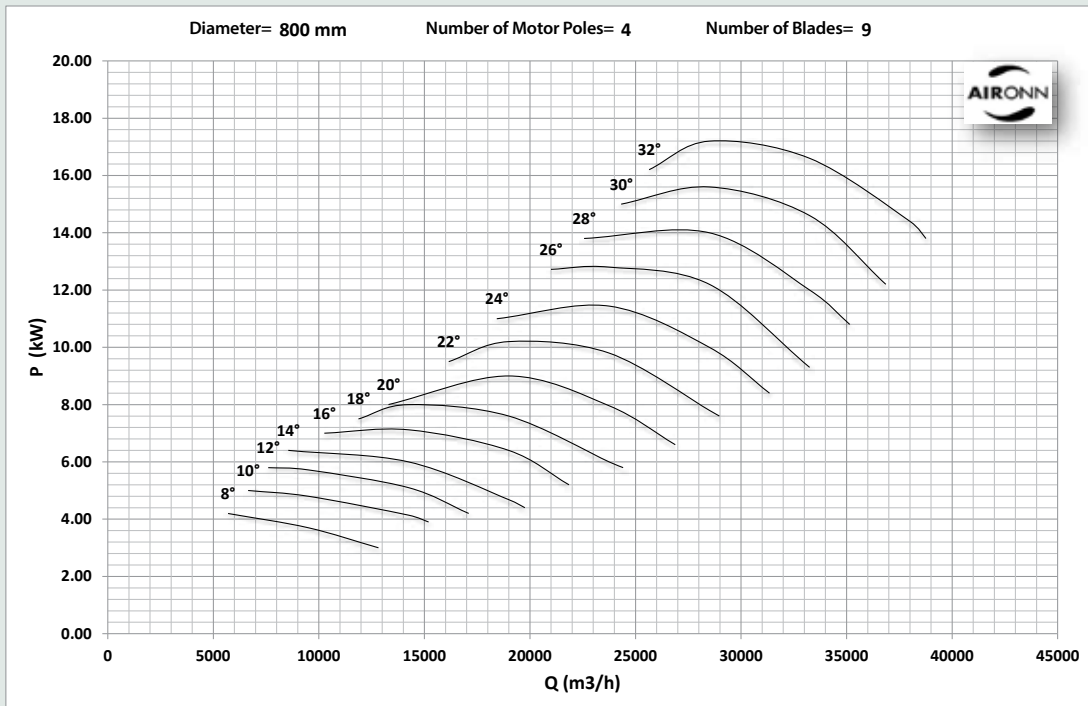
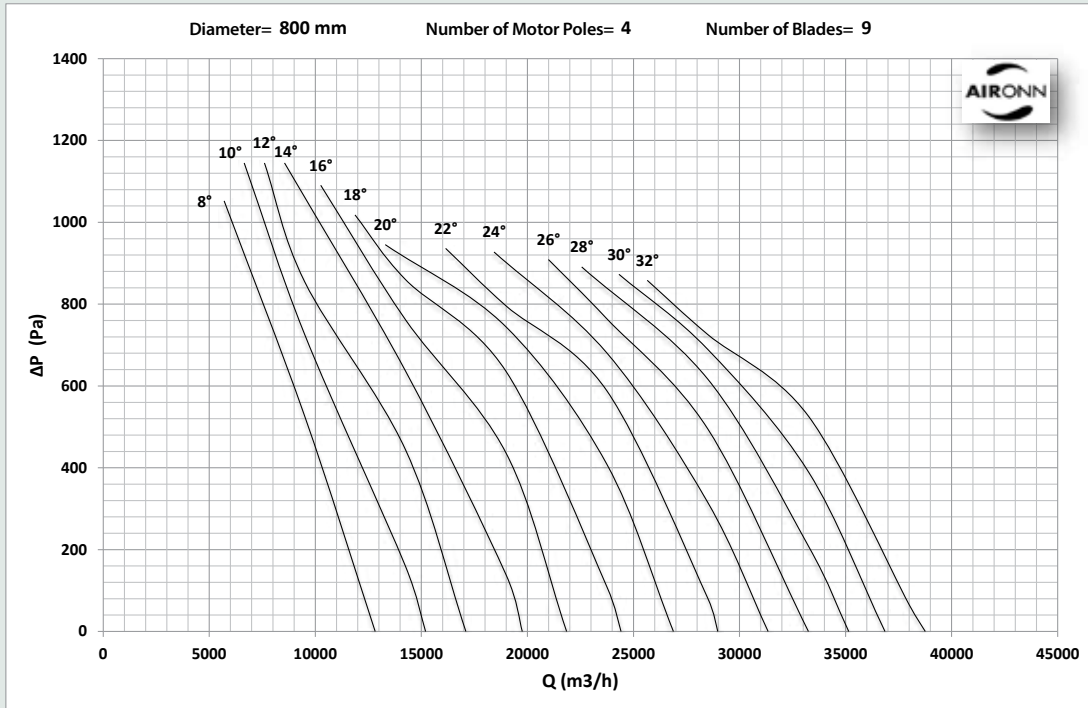

## Twin Spindle Axial Type Fresh Air Fan Series

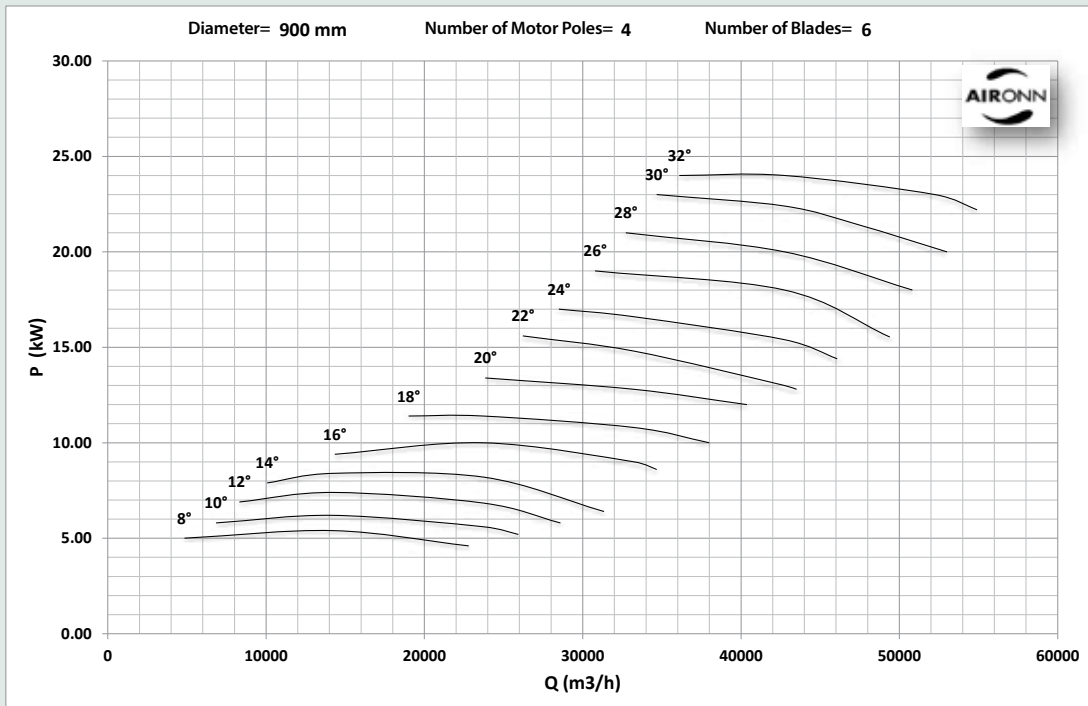
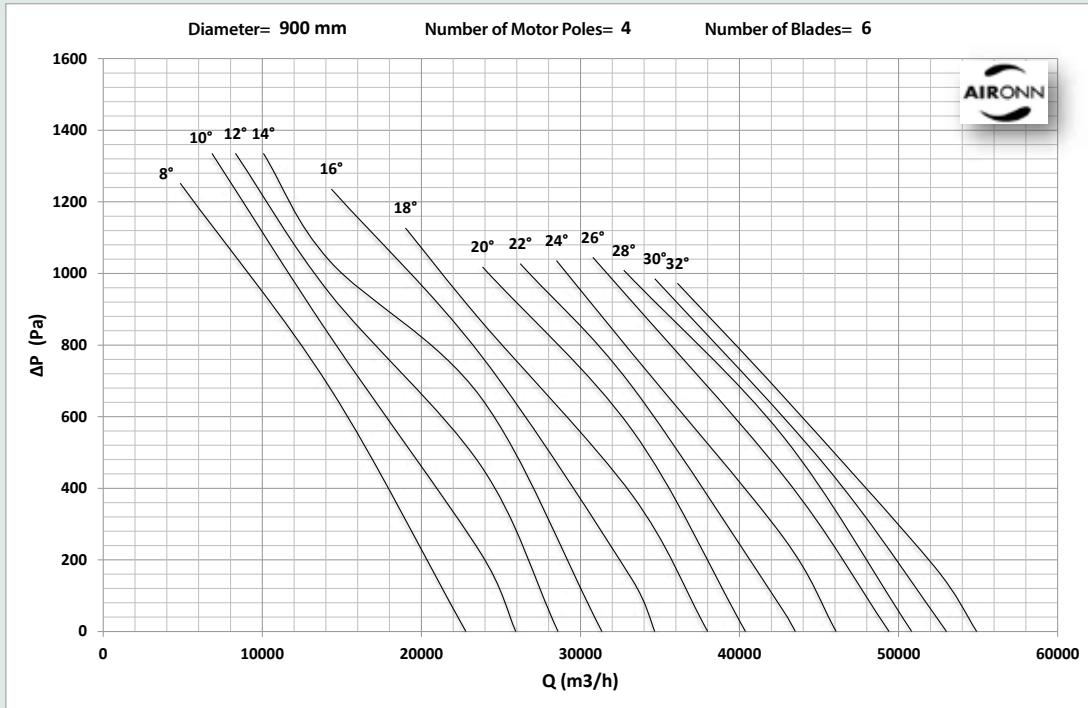

## Twin Spindle Axial Type Fresh Air Fan Series

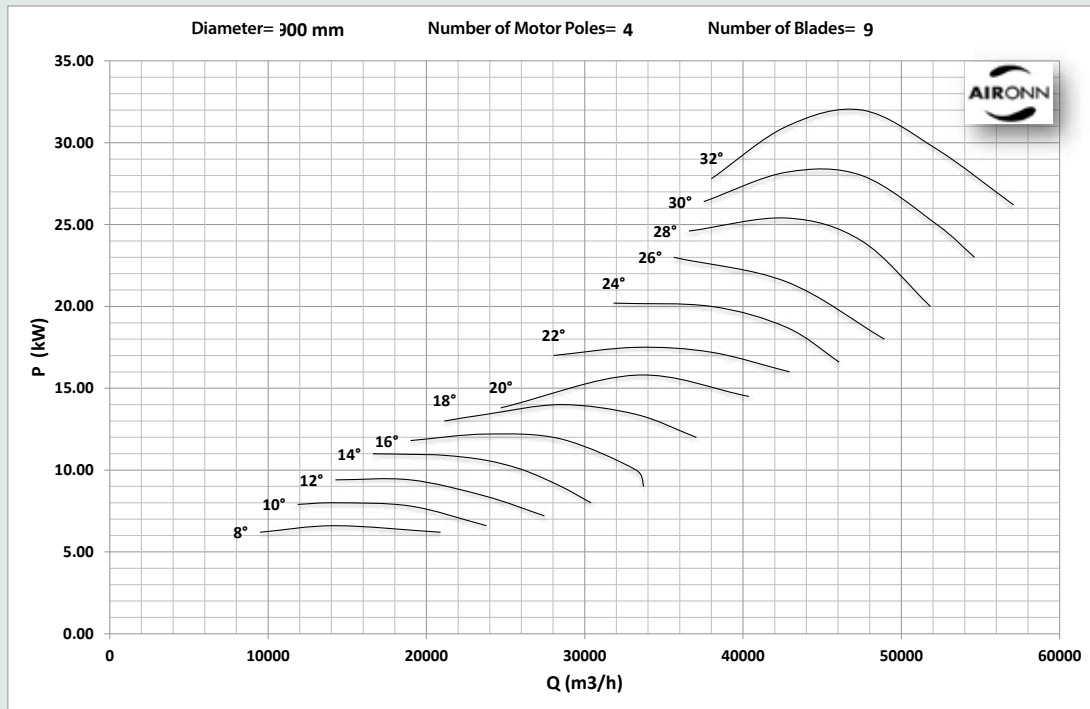
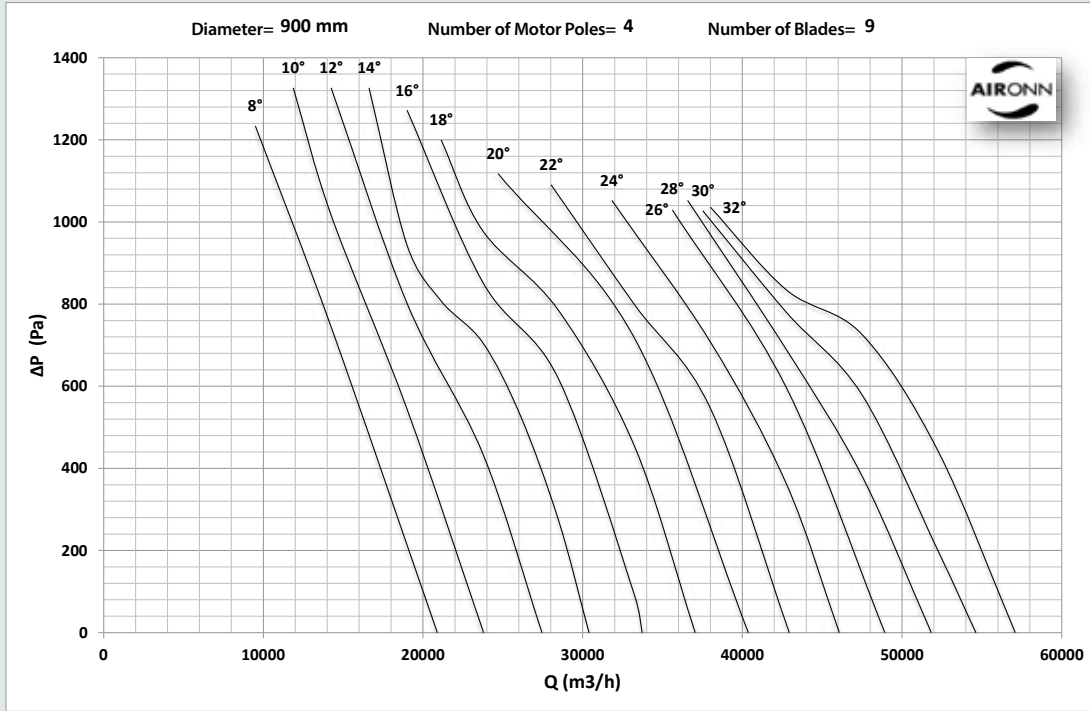

## Twin Spindle Axial Type Fresh Air Fan Series

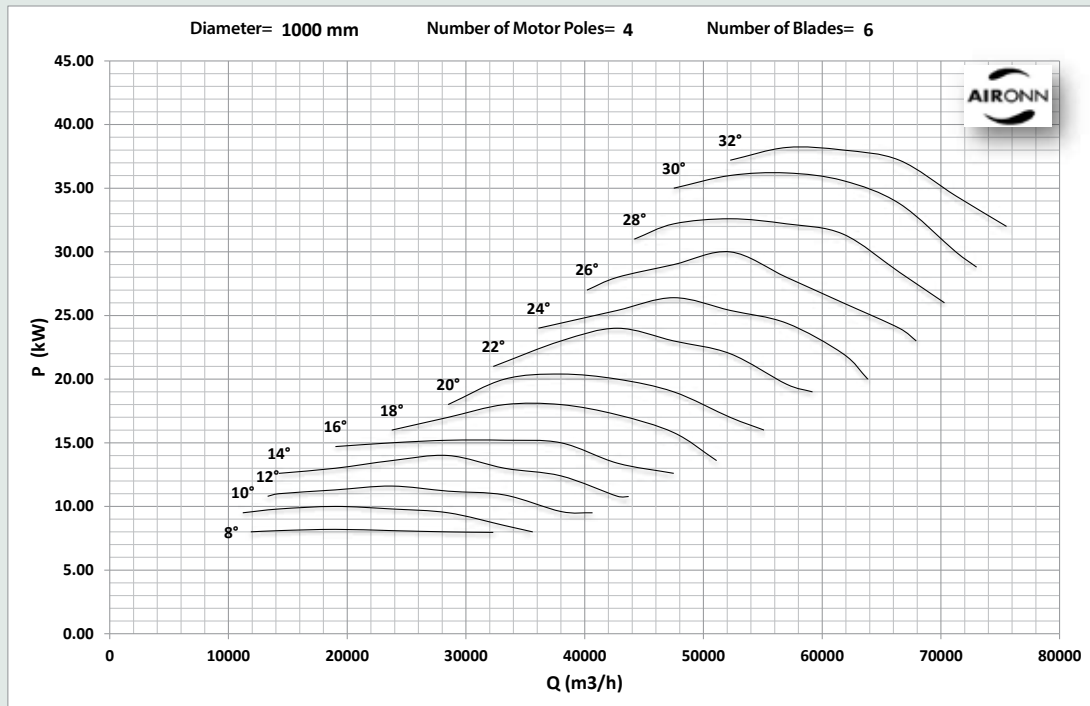
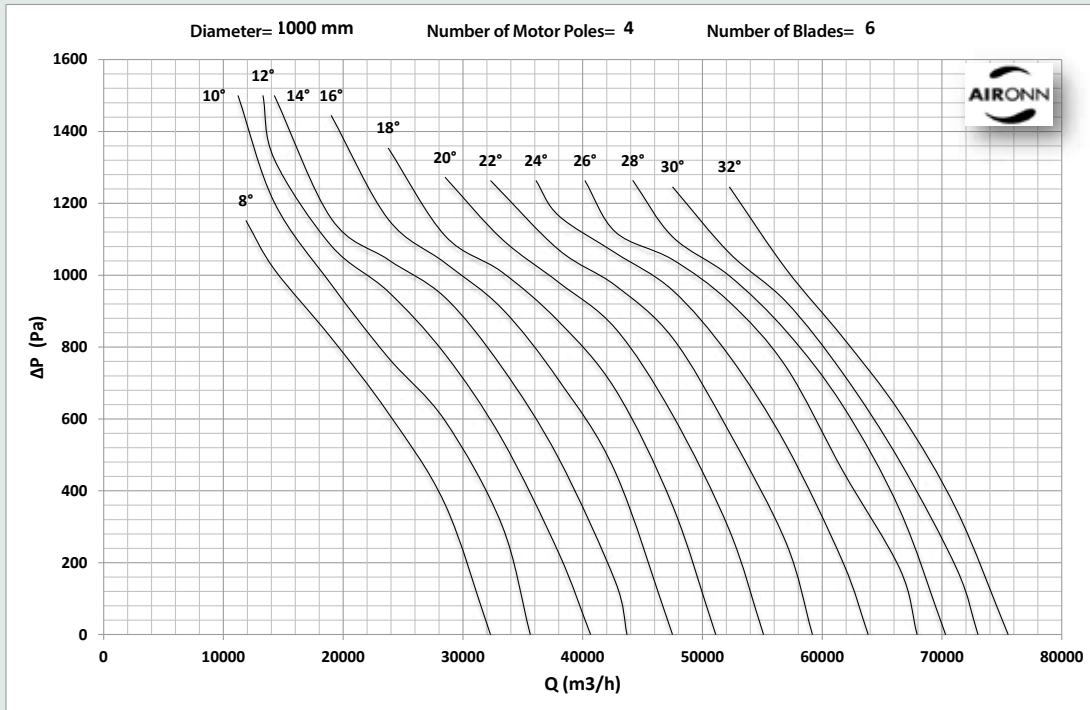



# Twin Spindle Axial Type Fresh Air Fan Series

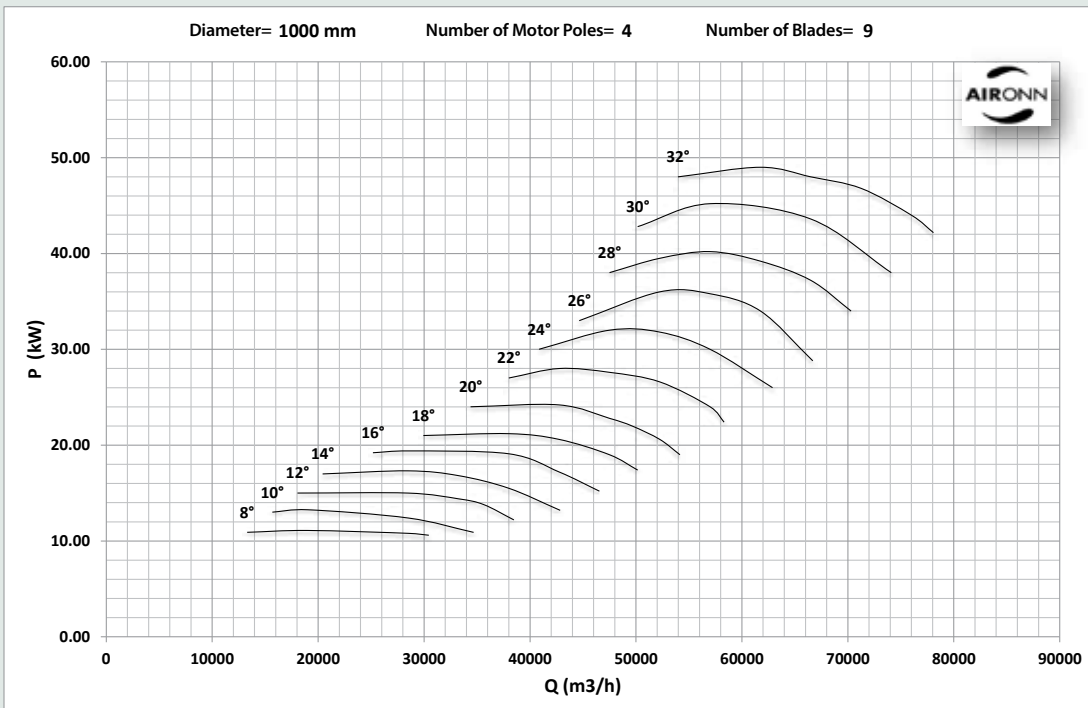
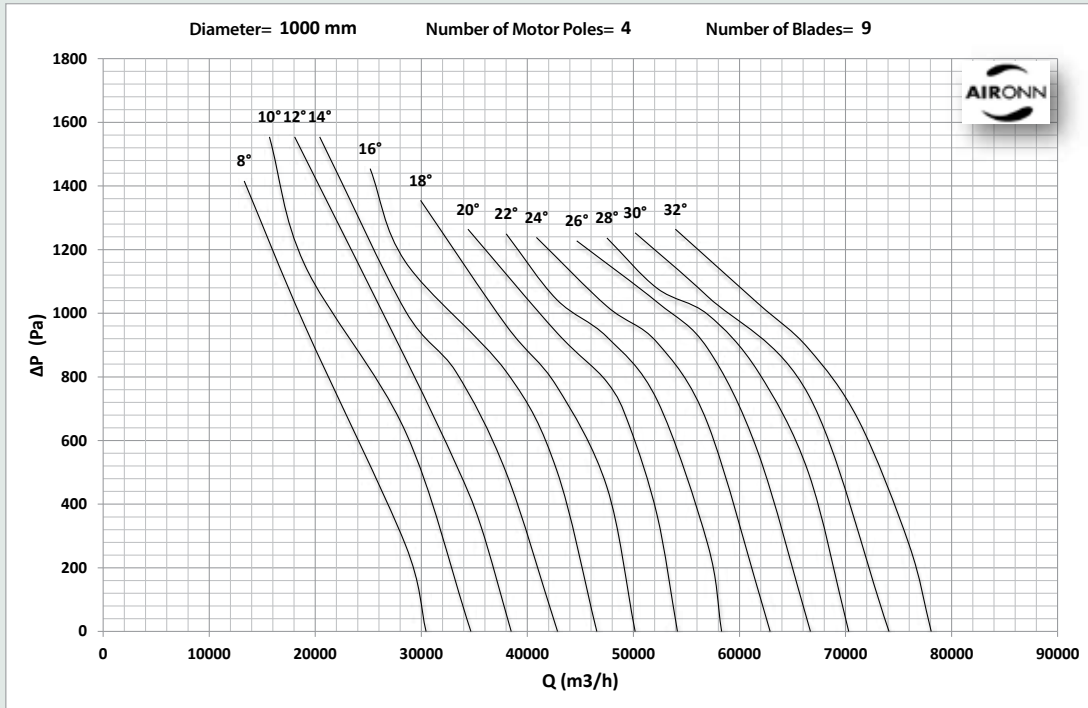

## Twin Spindle Axial Type Fresh Air Fan Series

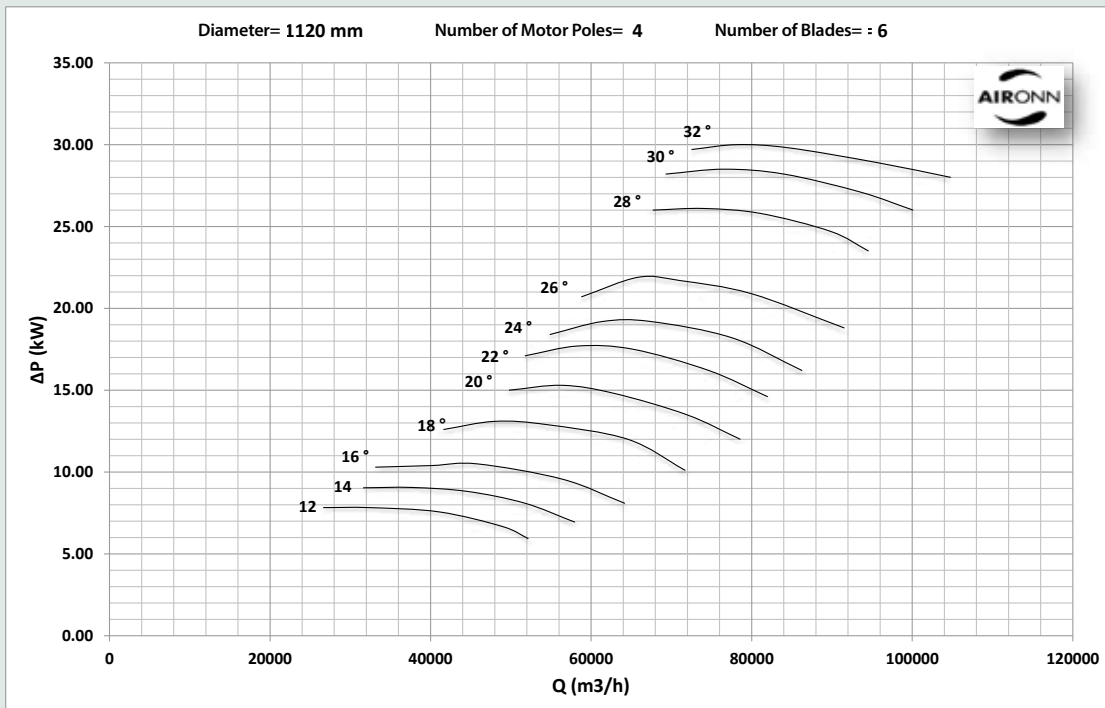
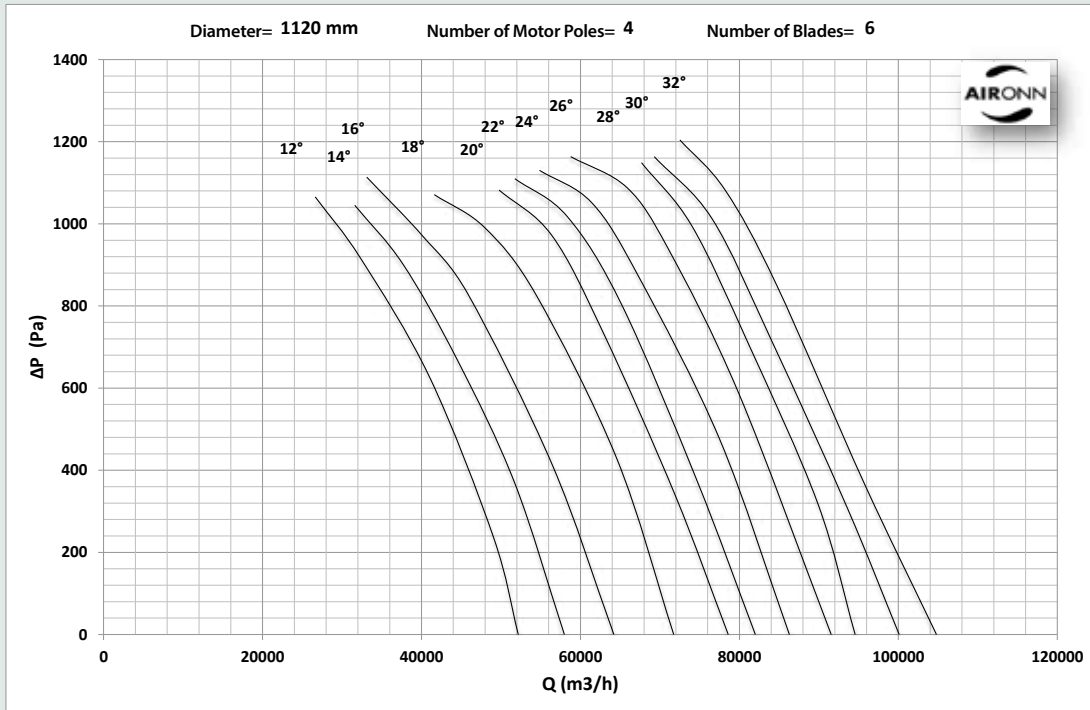

## Twin Spindle Axial Type Fresh Air Fan Series

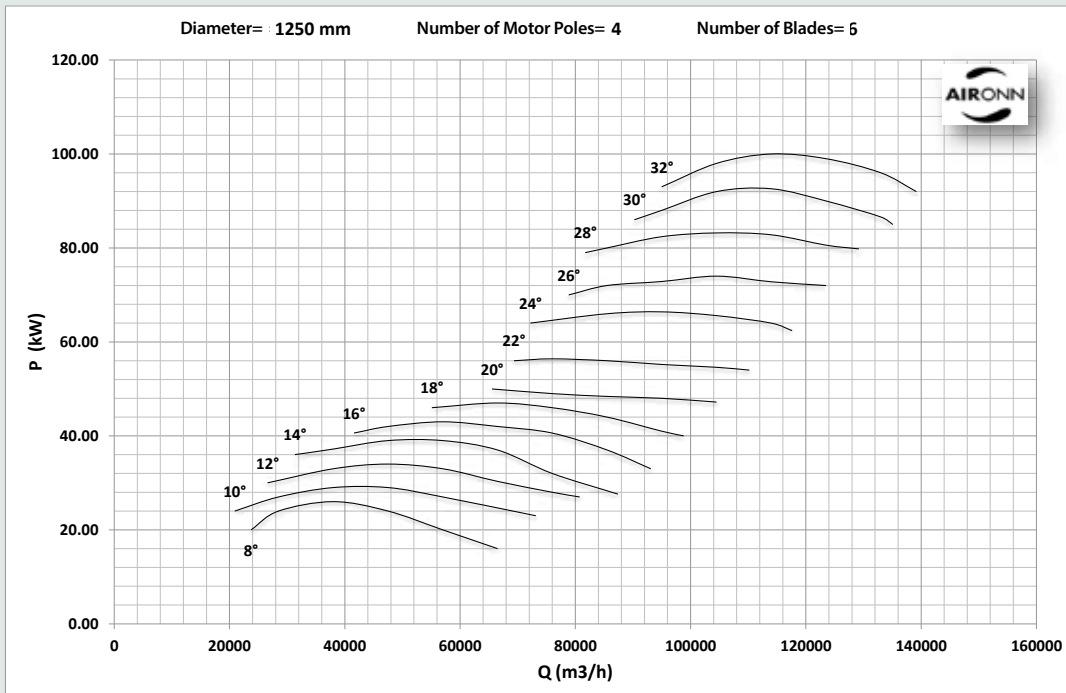
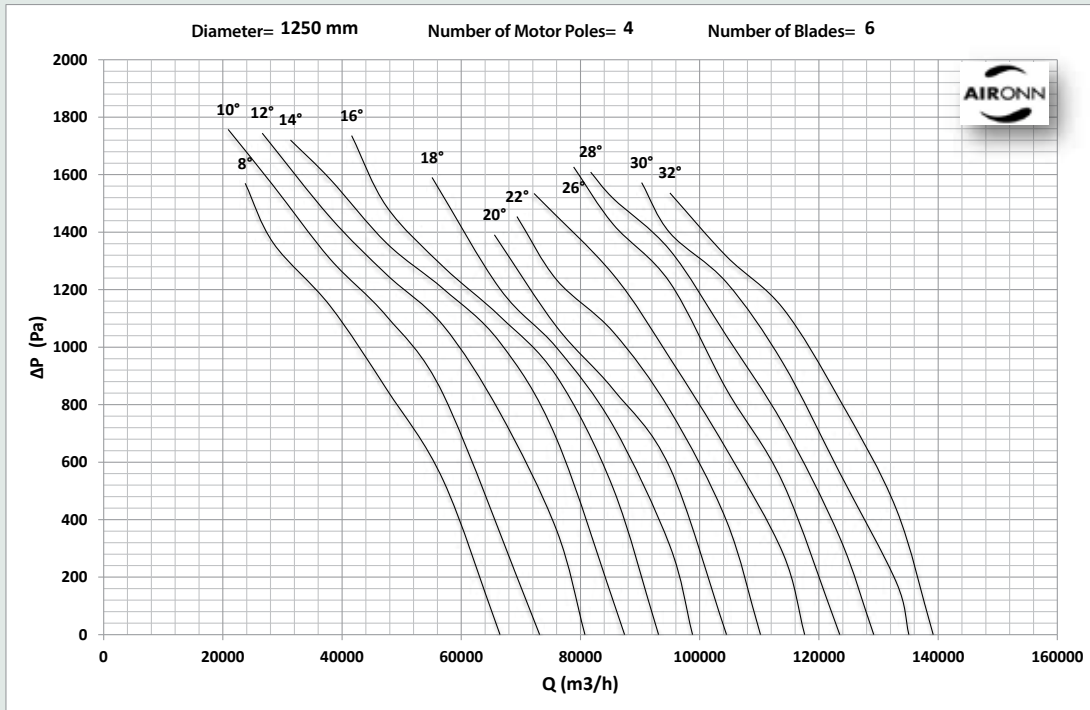

## Twin Spindle Axial Type Fresh Air Fan Series

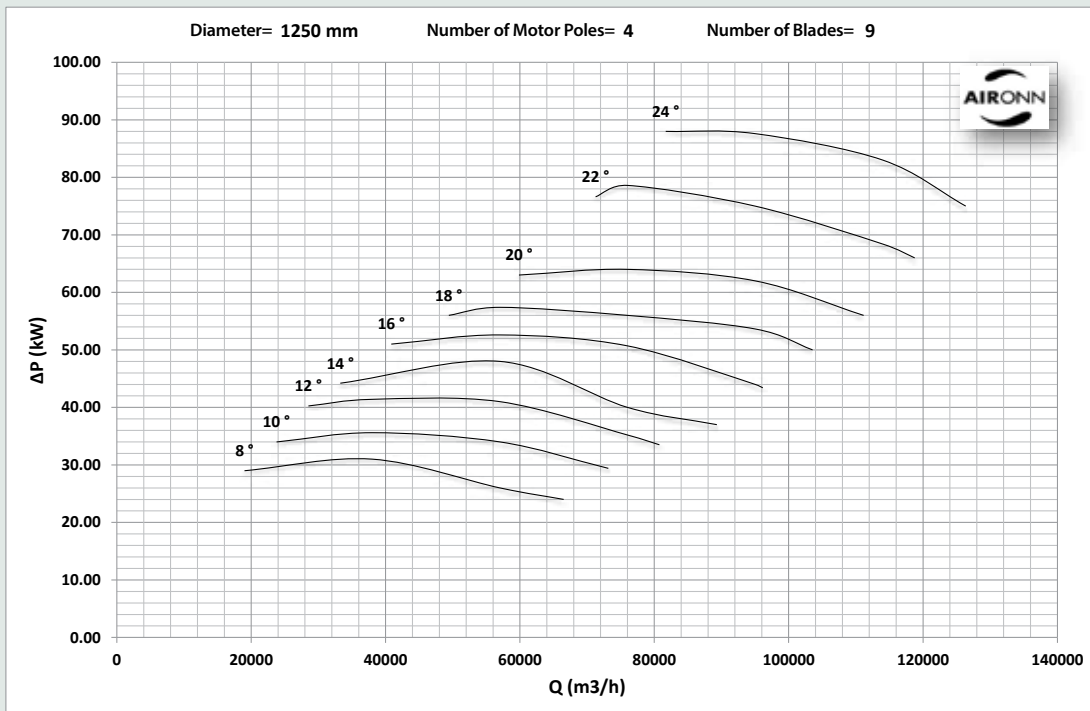
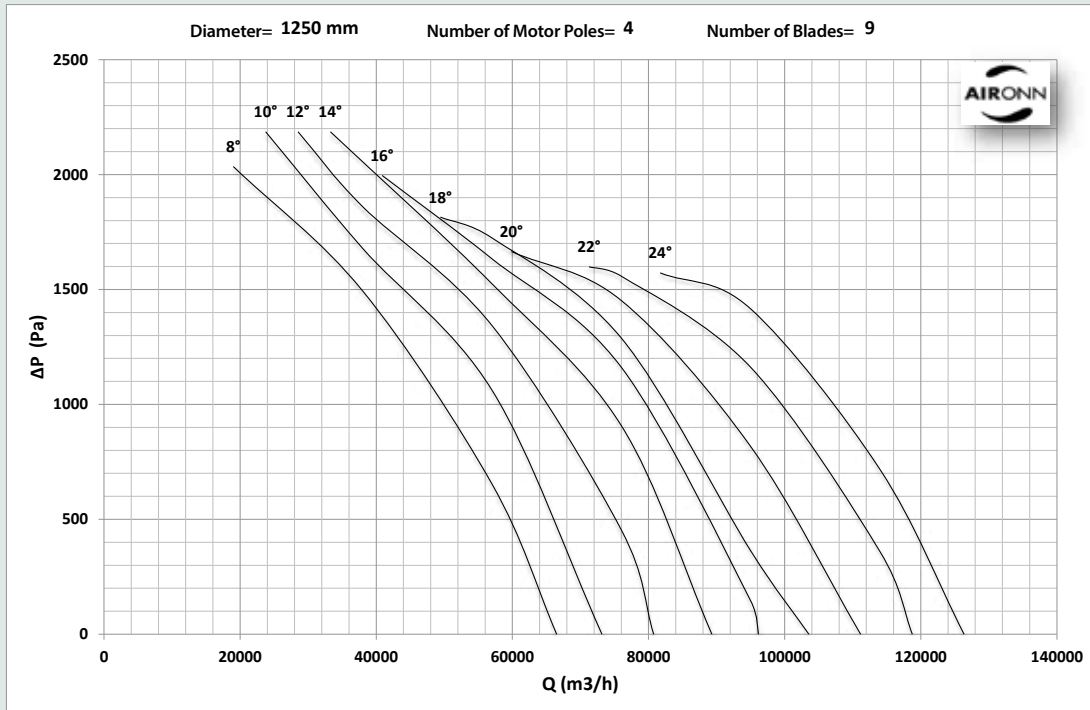

# Twin Spindle Axial Type Smoke Exhaust Fan Series

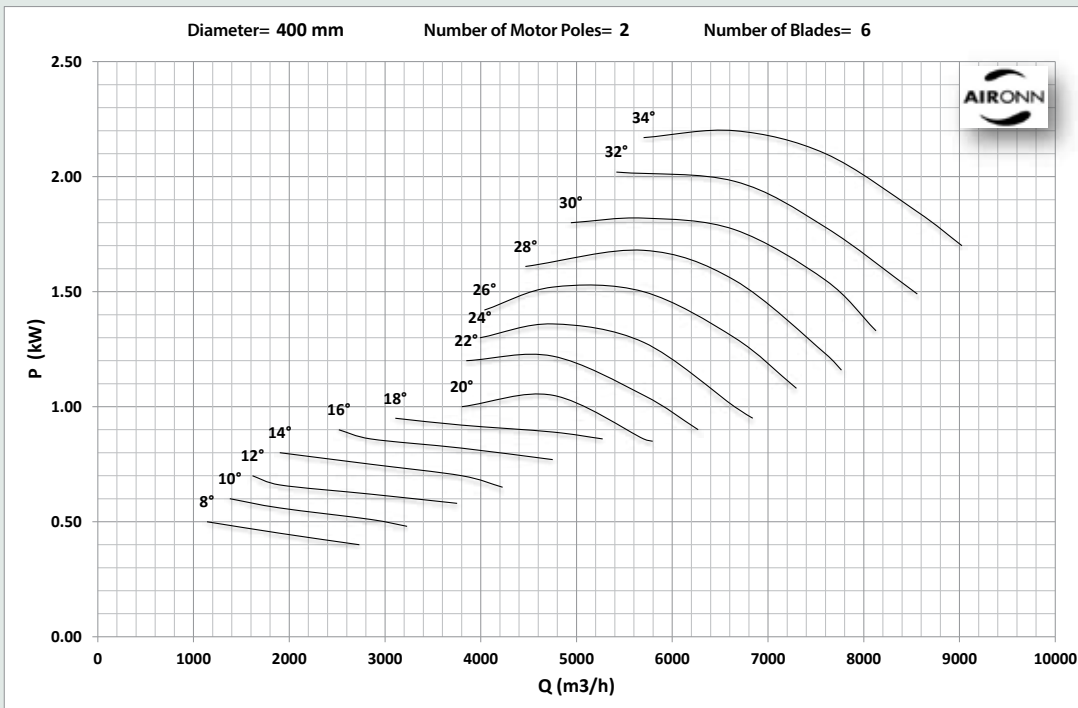
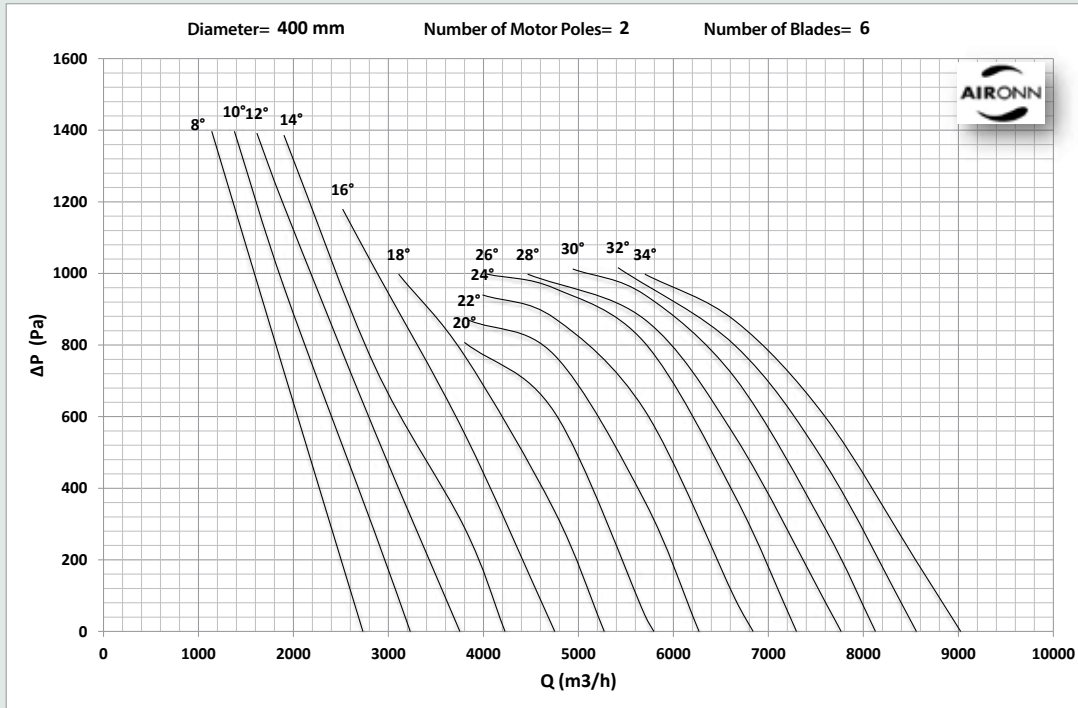

# Twin Spindle Axial Type Smoke Exhaust Fan Series

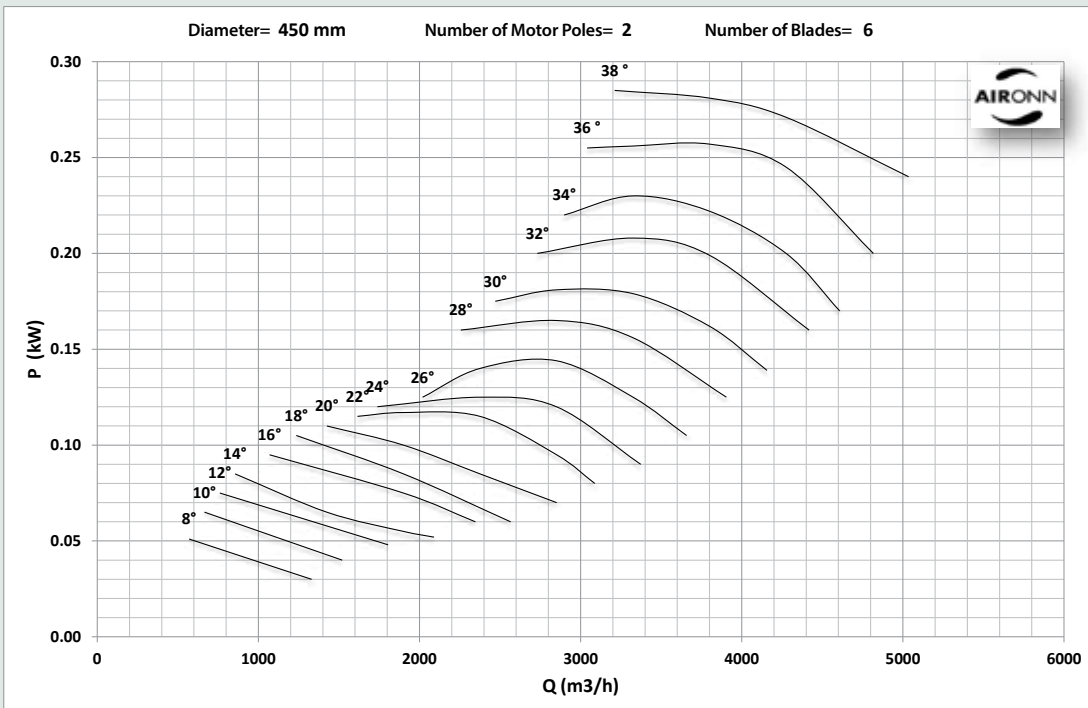
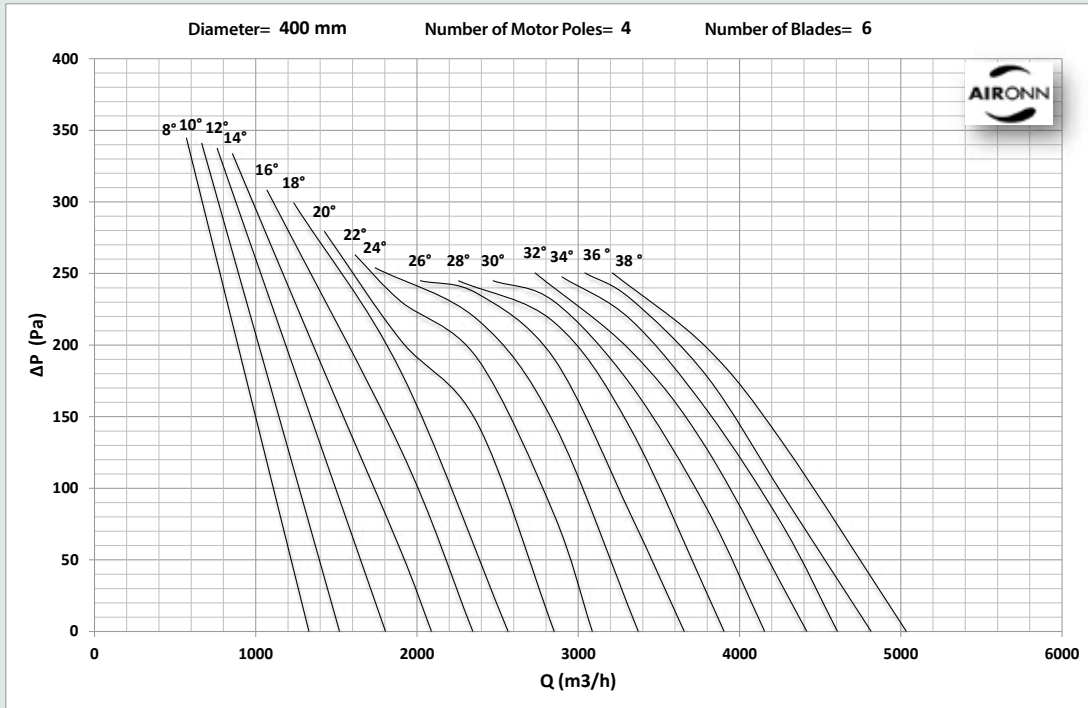

# Twin Spindle Axial Type Smoke Exhaust Fan Series

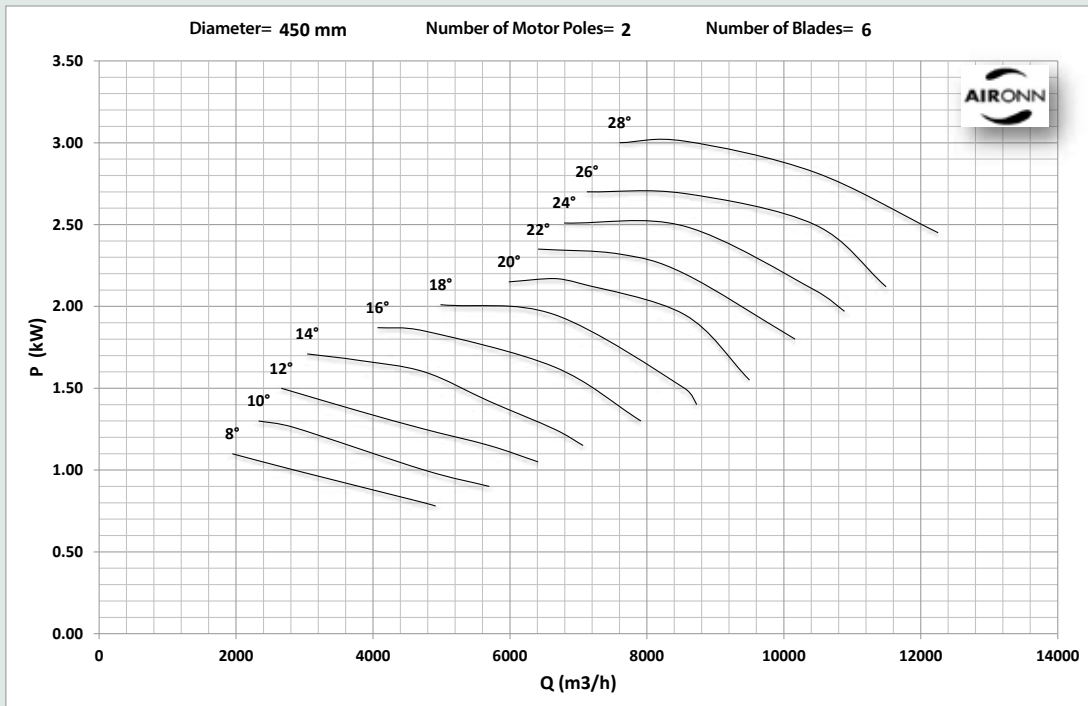
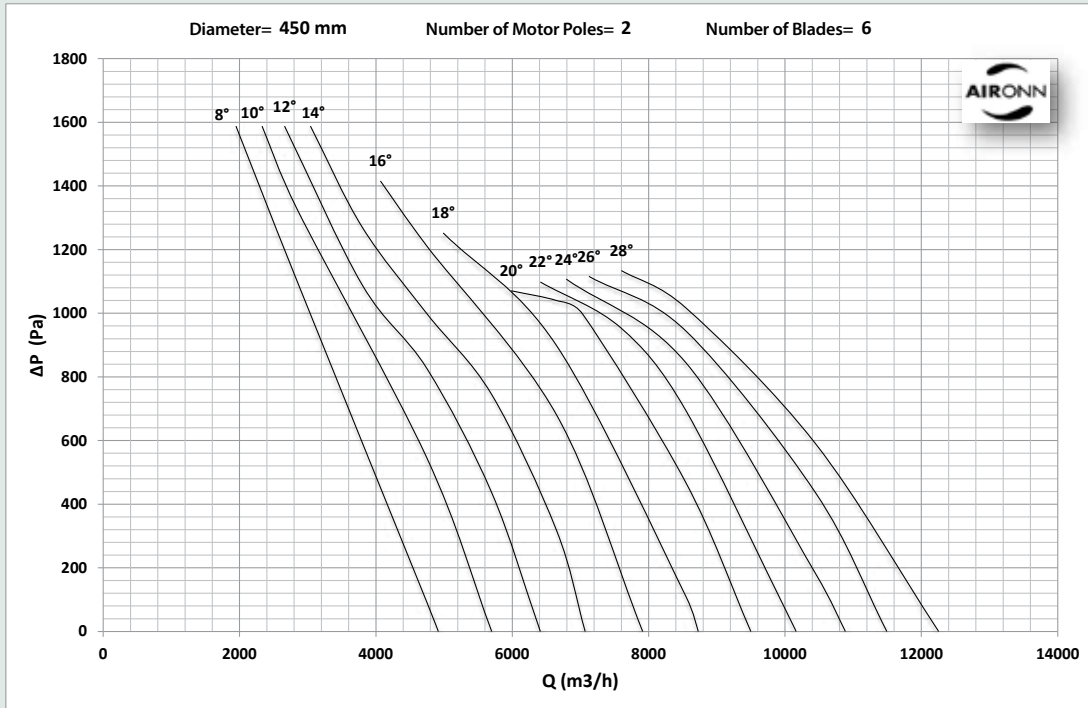

# Twin Spindle Axial Type Smoke Exhaust Fan Series

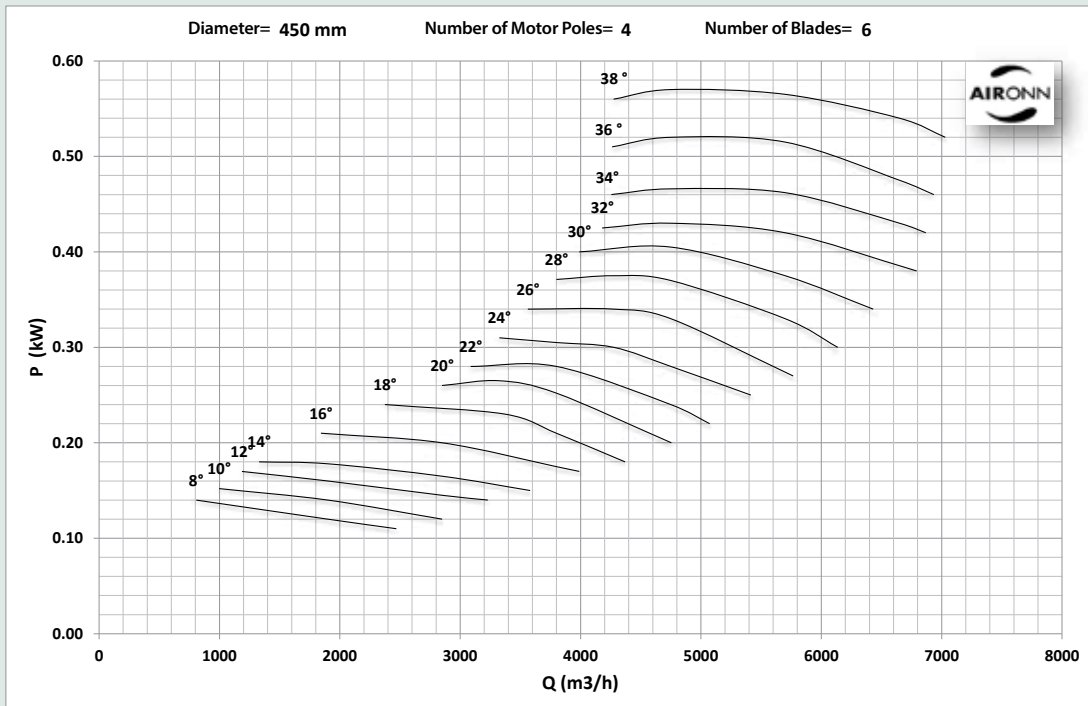
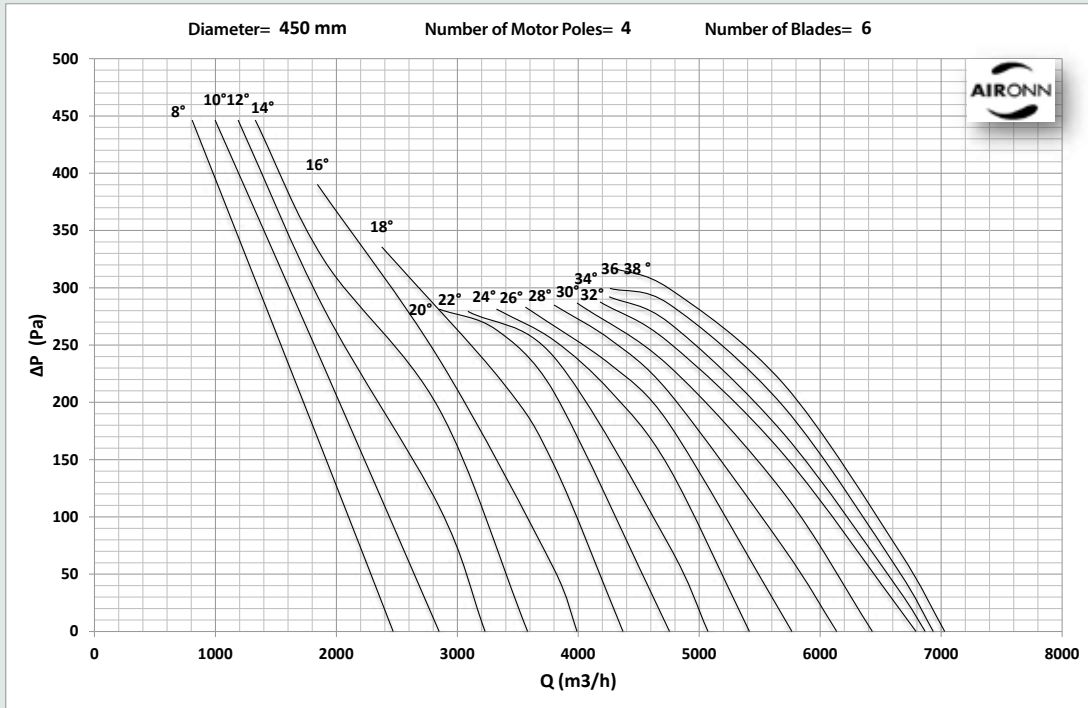



# Twin Spindle Axial Type Smoke Exhaust Fan Series

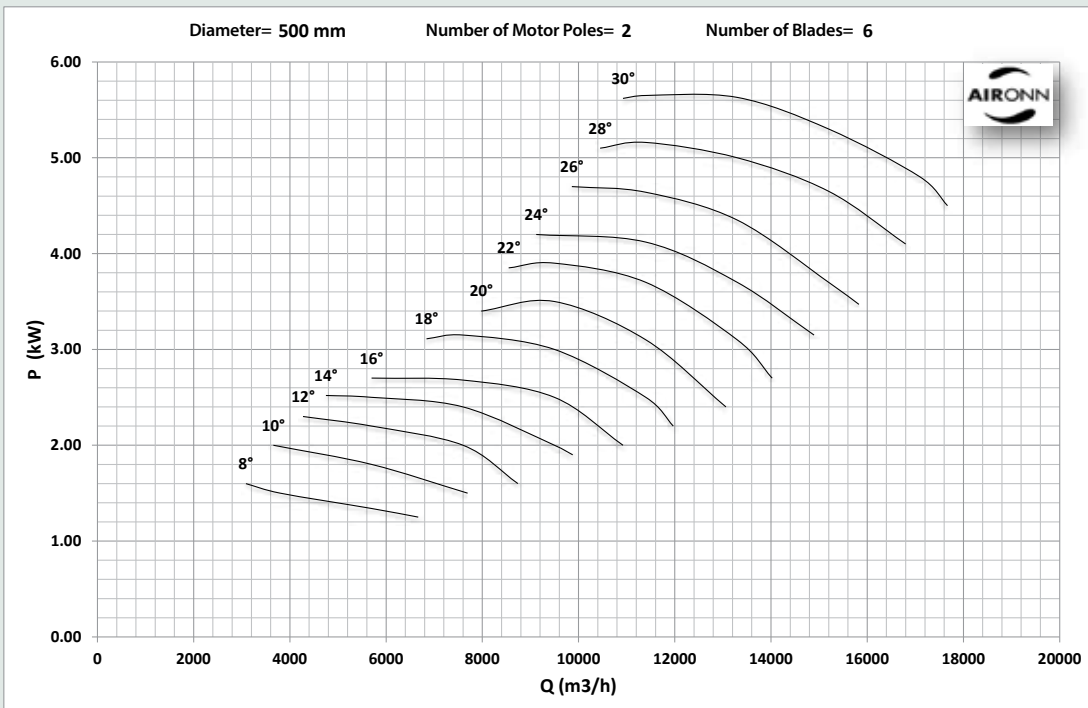
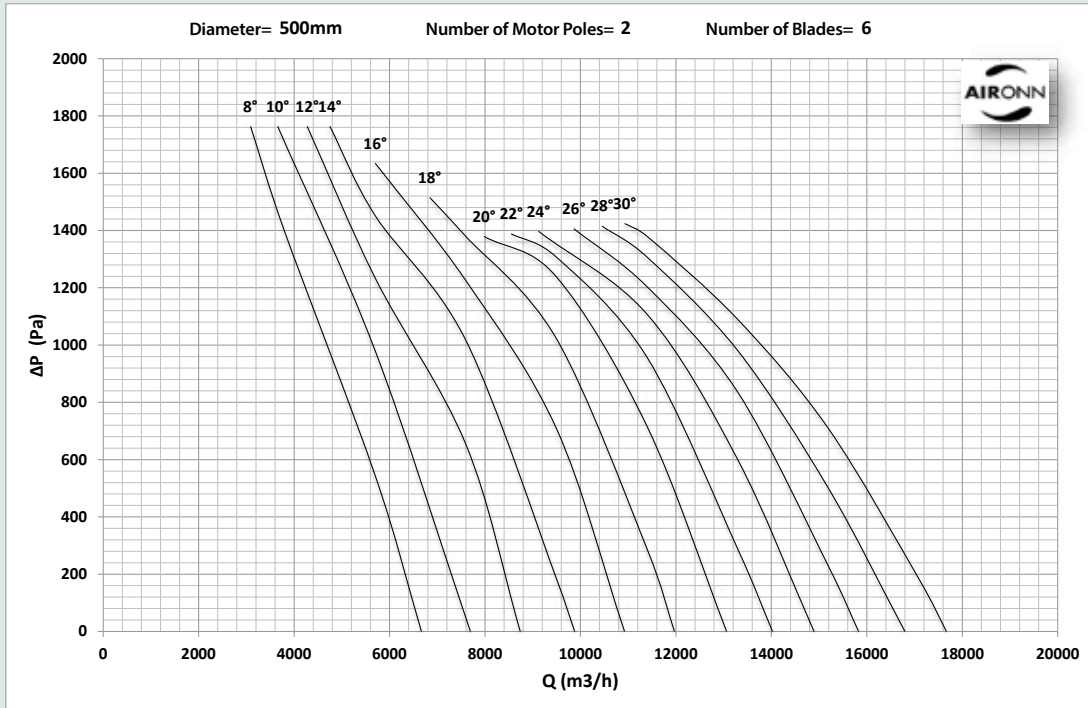

# Twin Spindle Axial Type Smoke Exhaust Fan Series

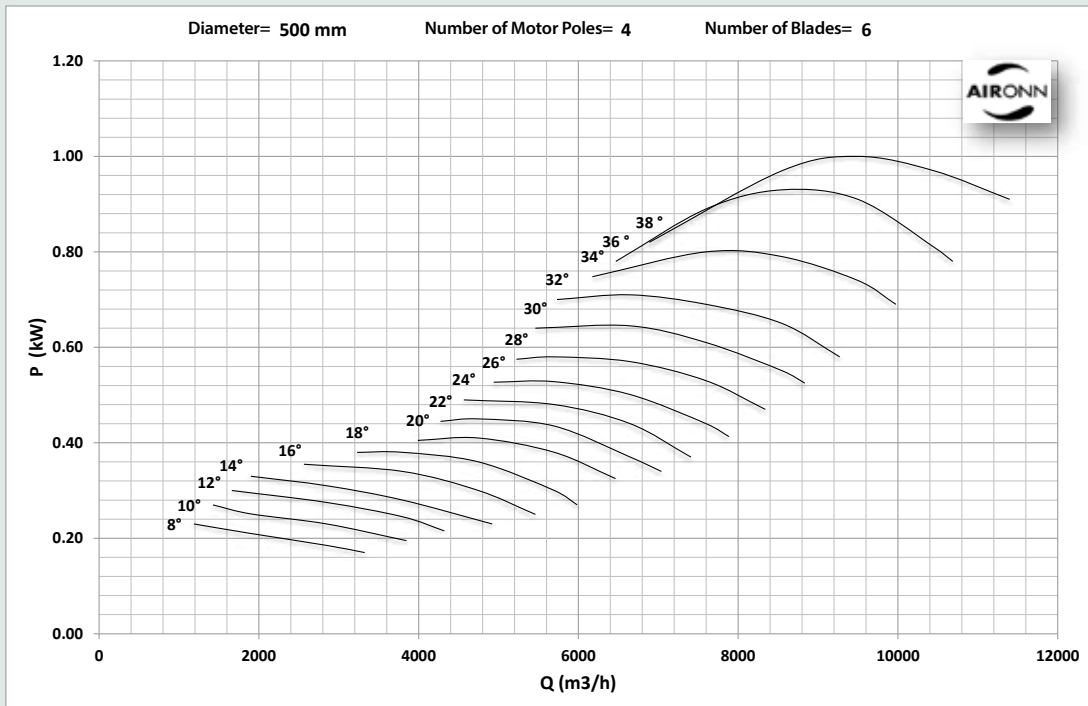
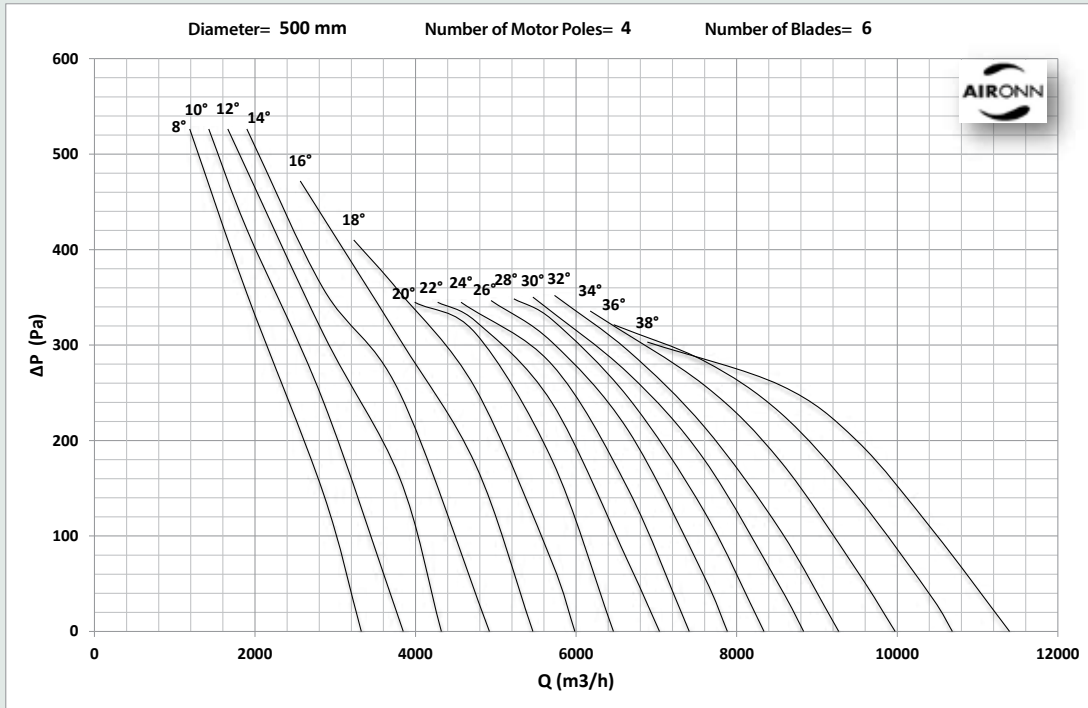

# Twin Spindle Axial Type Smoke Exhaust Fan Series

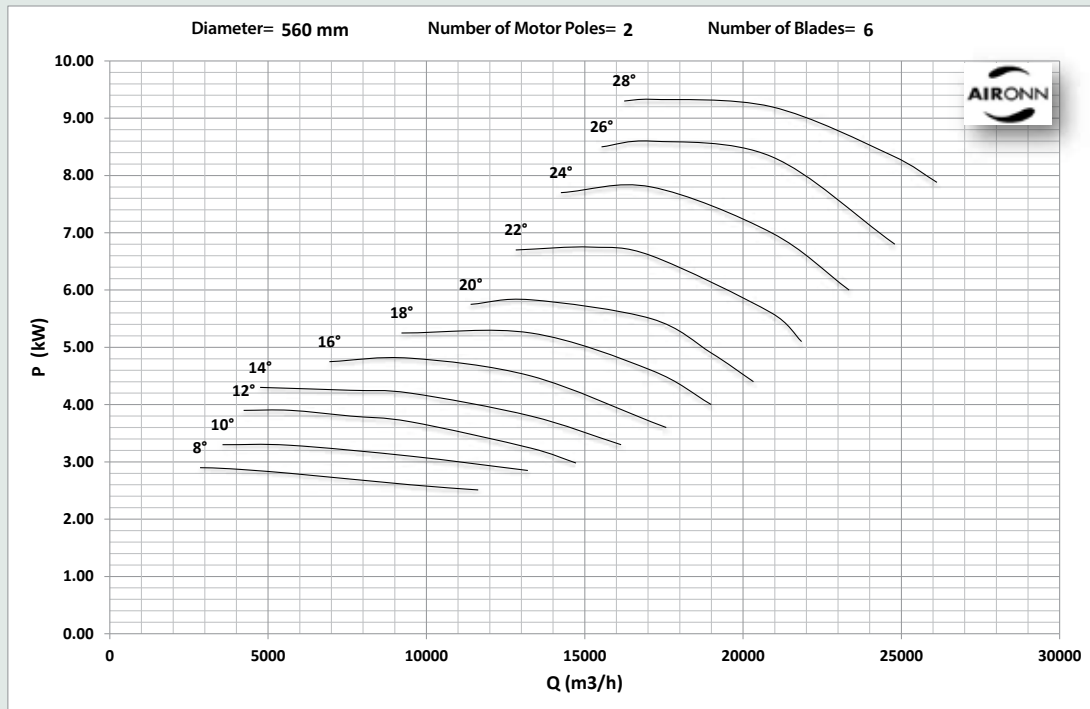
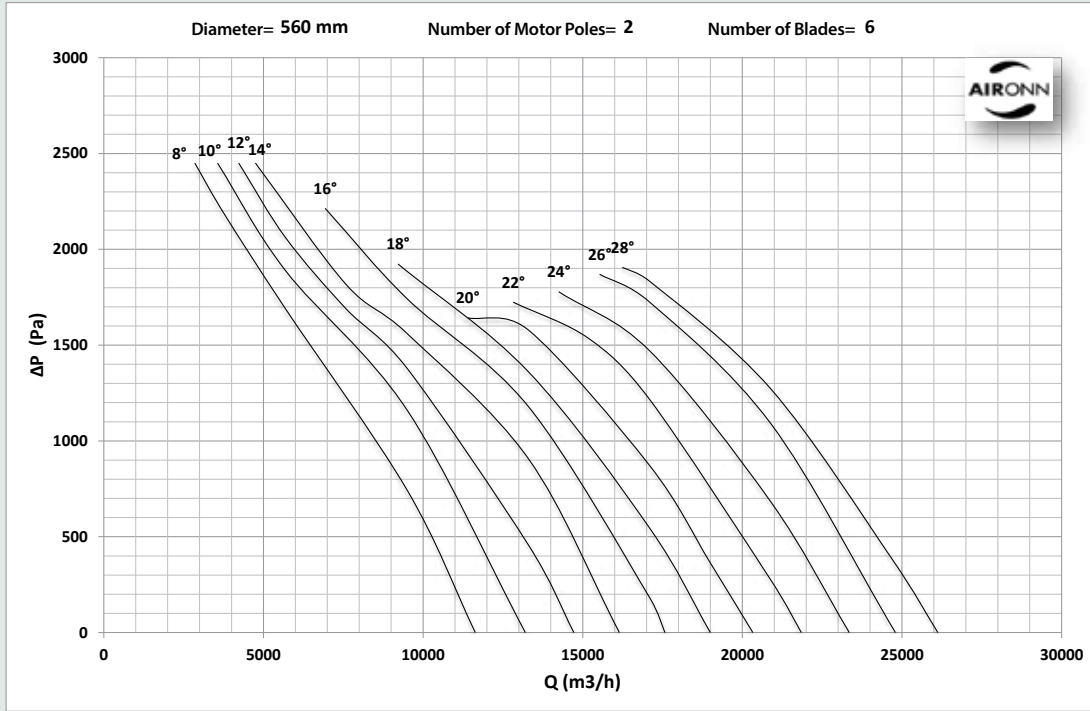

# Twin Spindle Axial Type Smoke Exhaust Fan Series

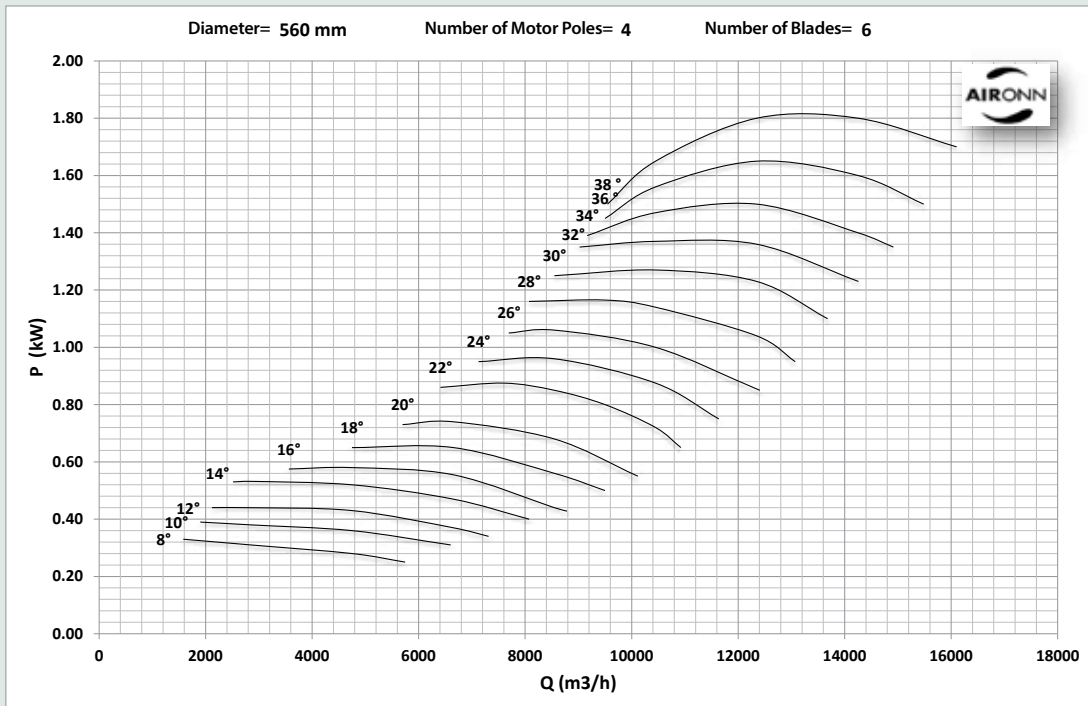
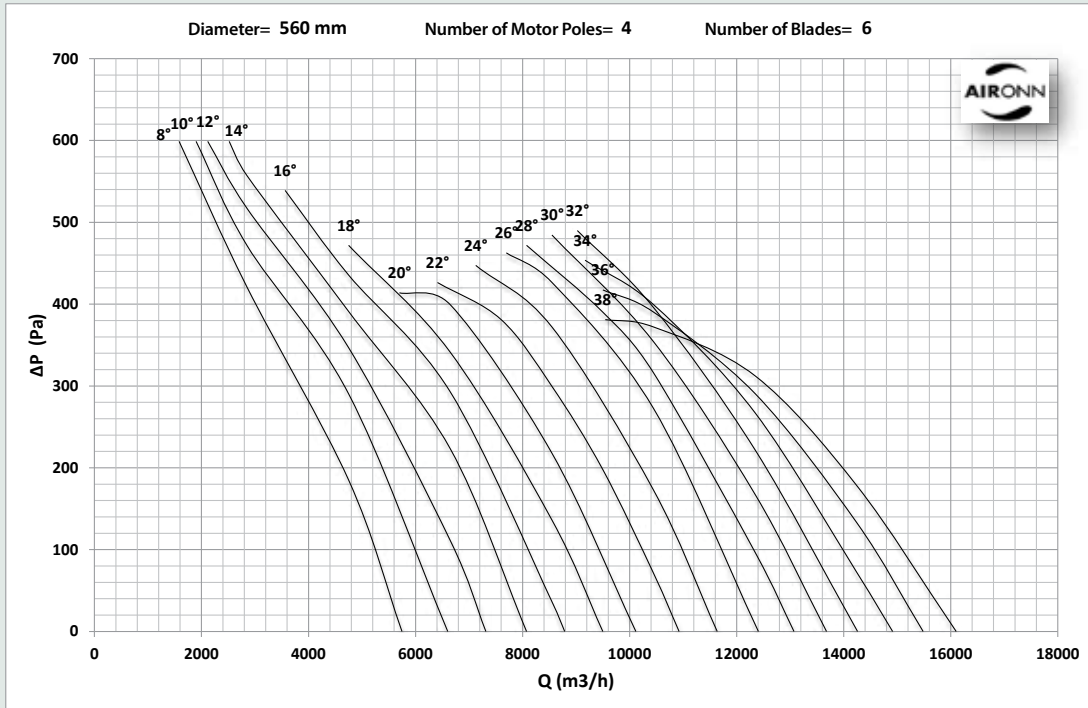

# Twin Spindle Axial Type Smoke Exhaust Fan Series

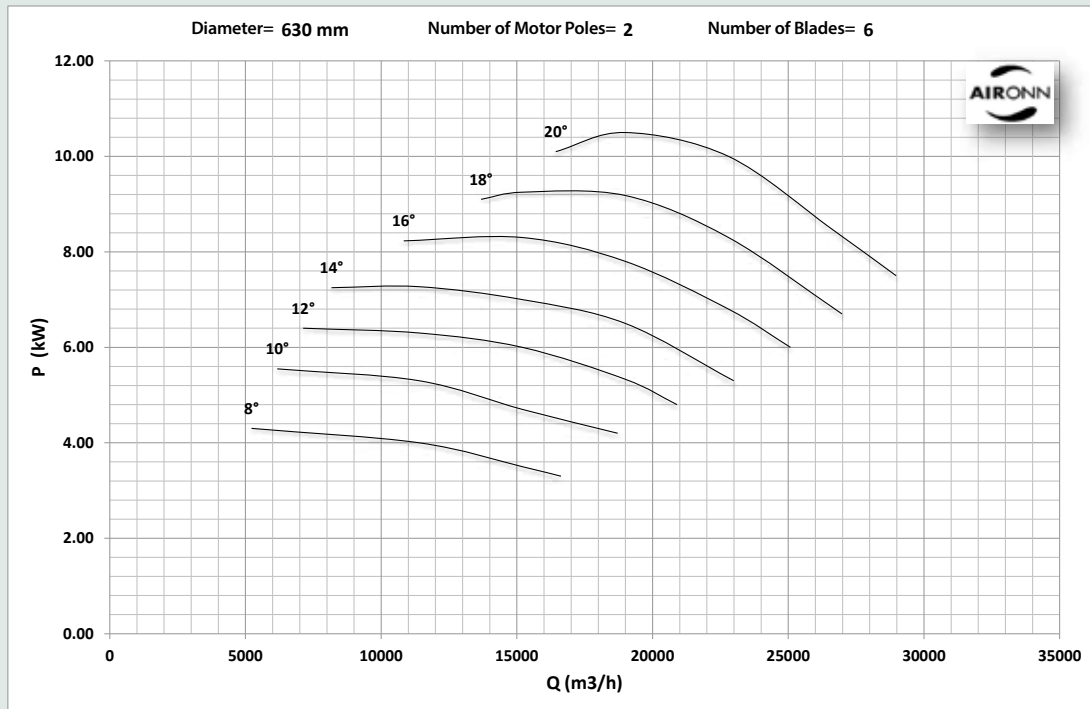
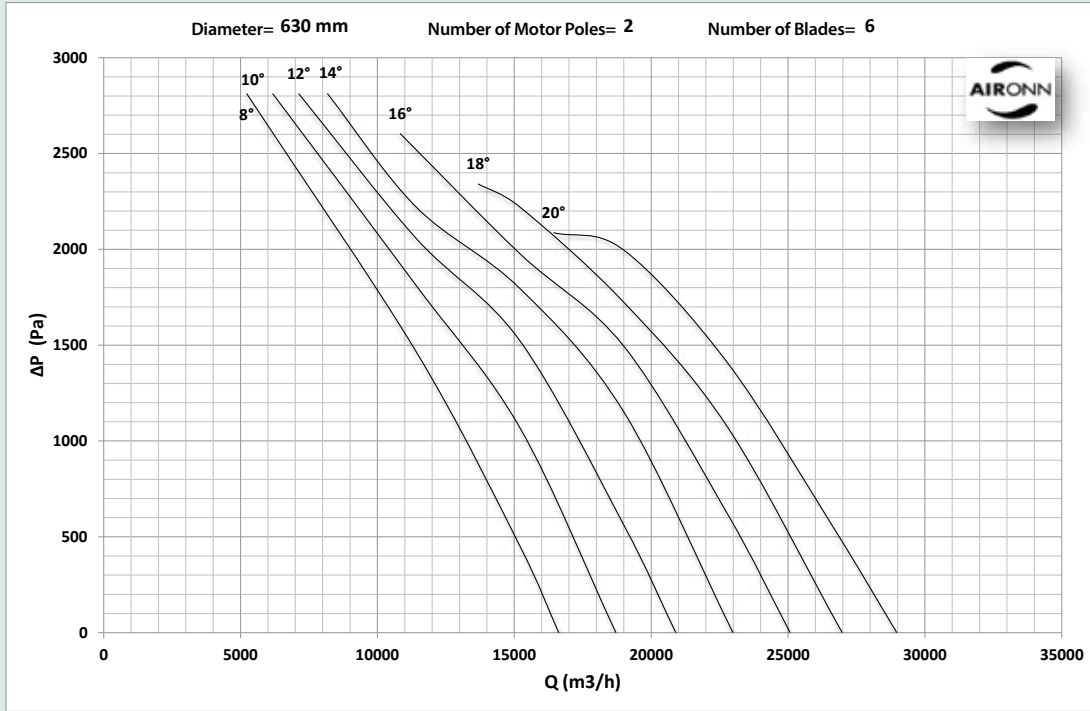

# Twin Spindle Axial Type Smoke Exhaust Fan Series

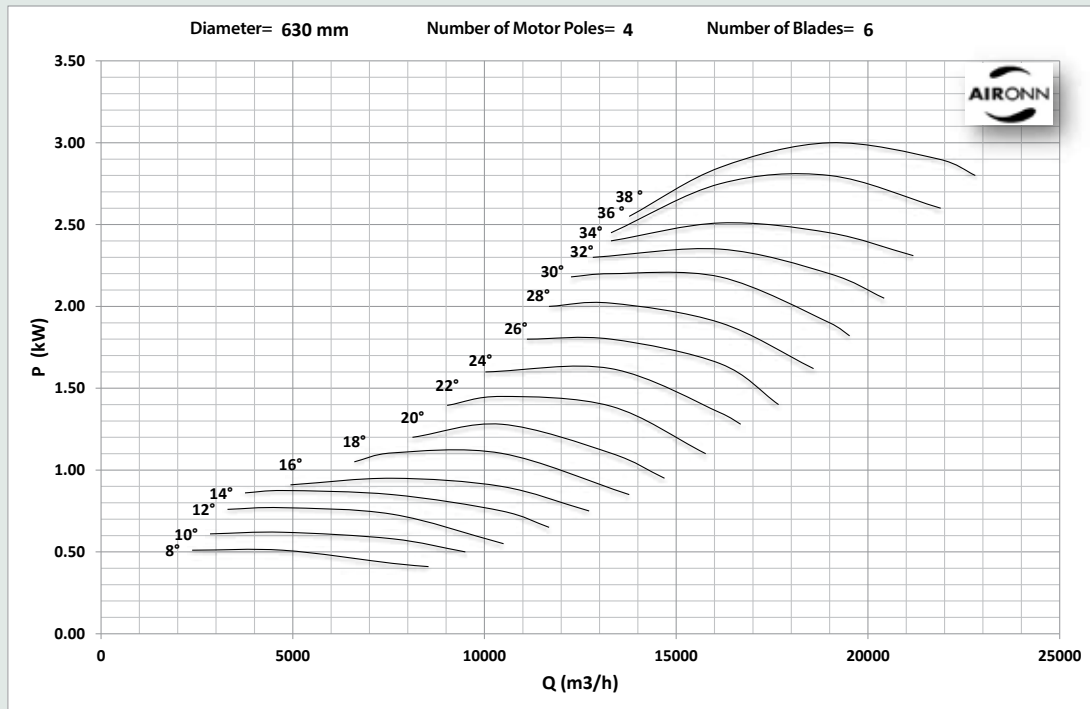
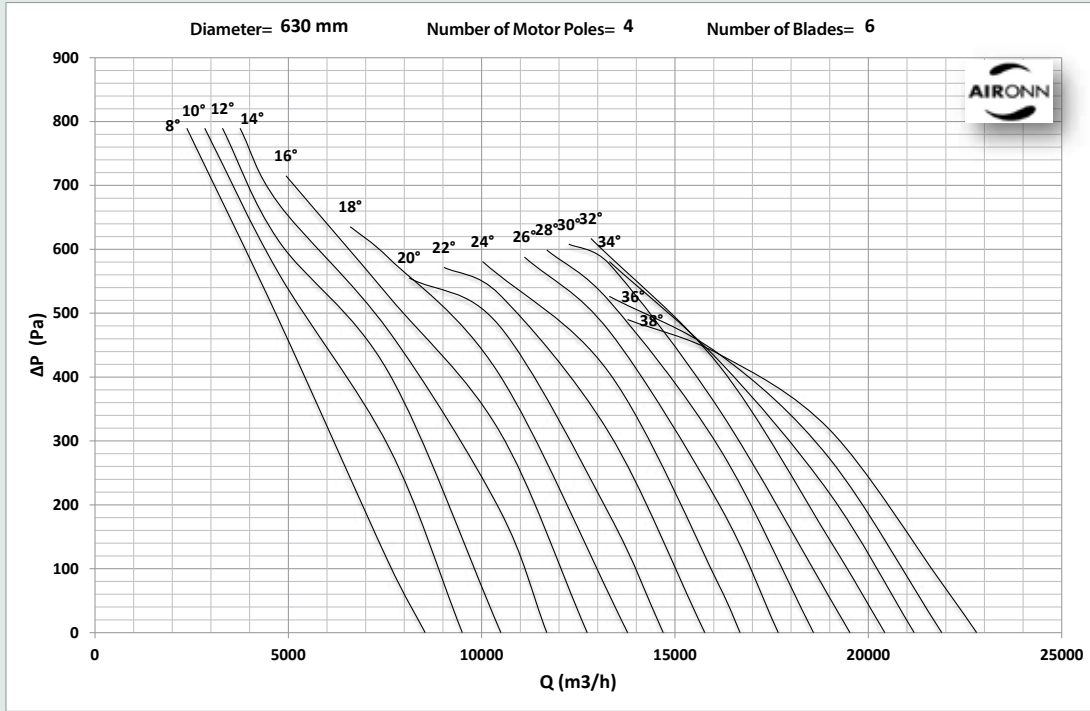

# Twin Spindle Axial Type Smoke Exhaust Fan Series

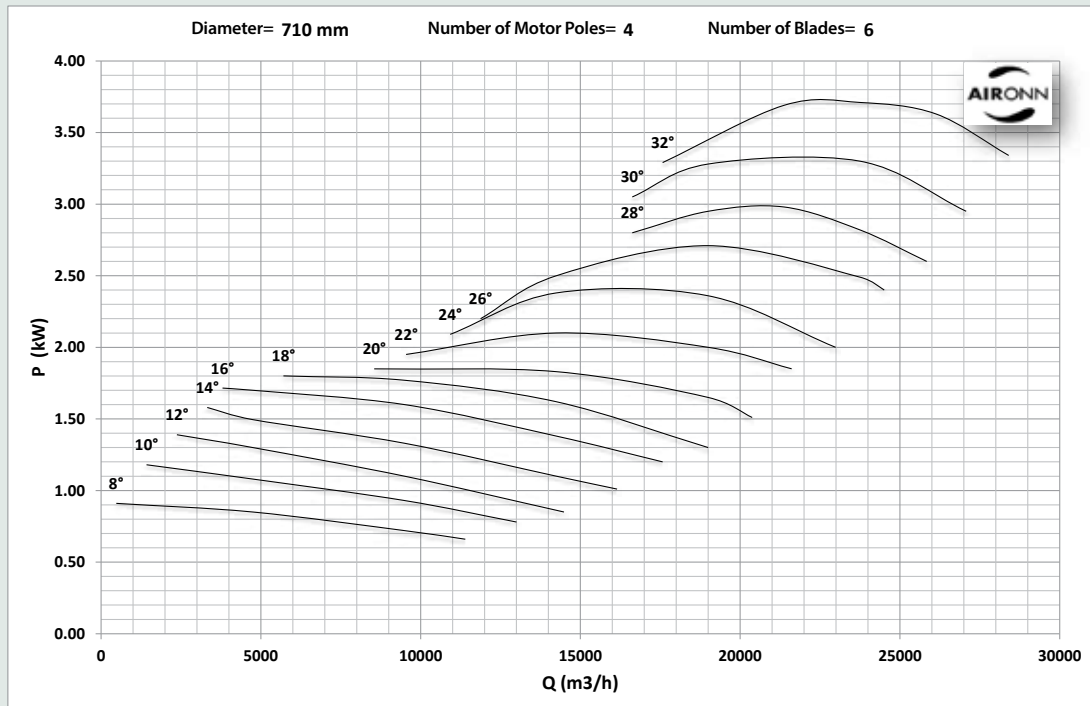
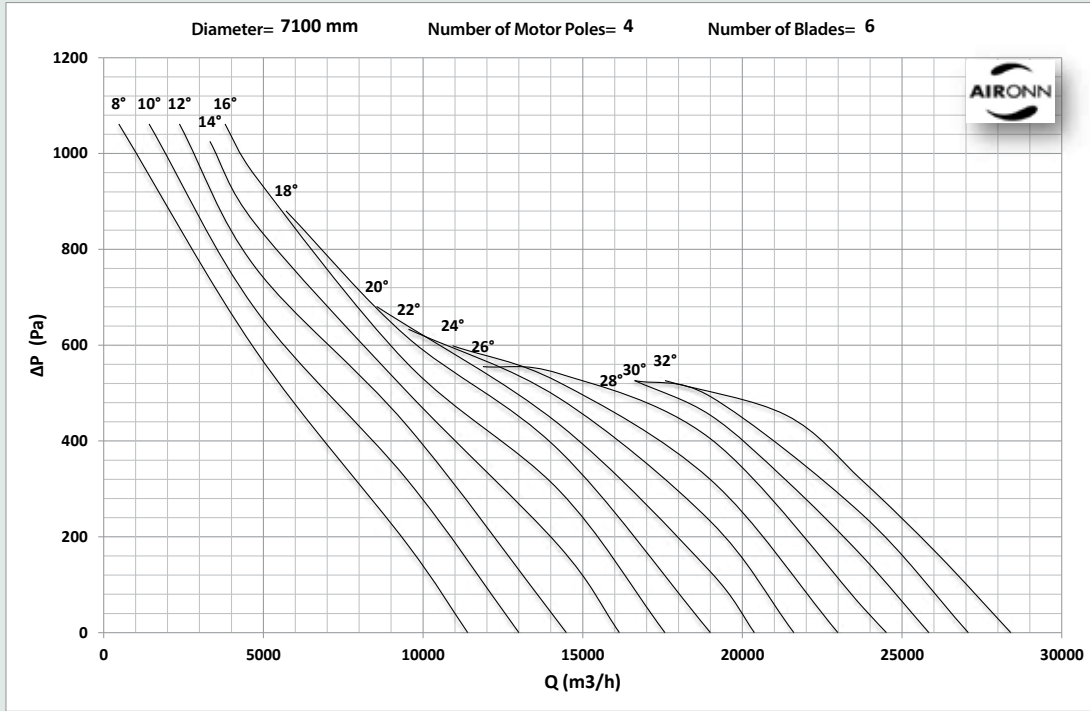

# Twin Spindle Axial Type Smoke Exhaust Fan Series

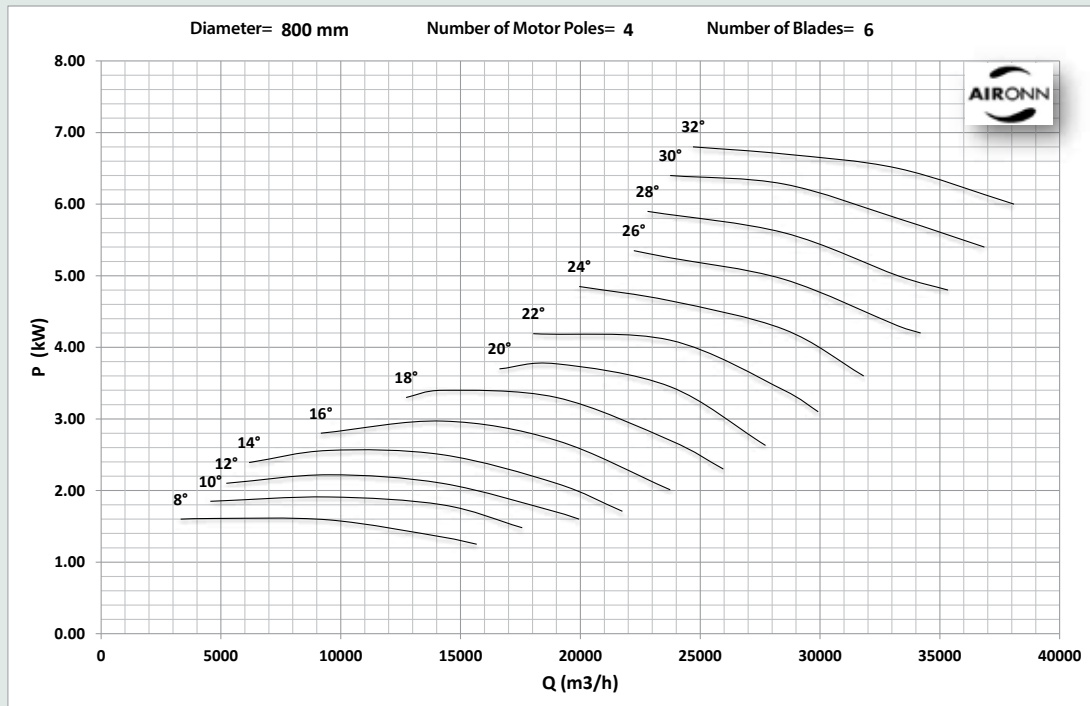
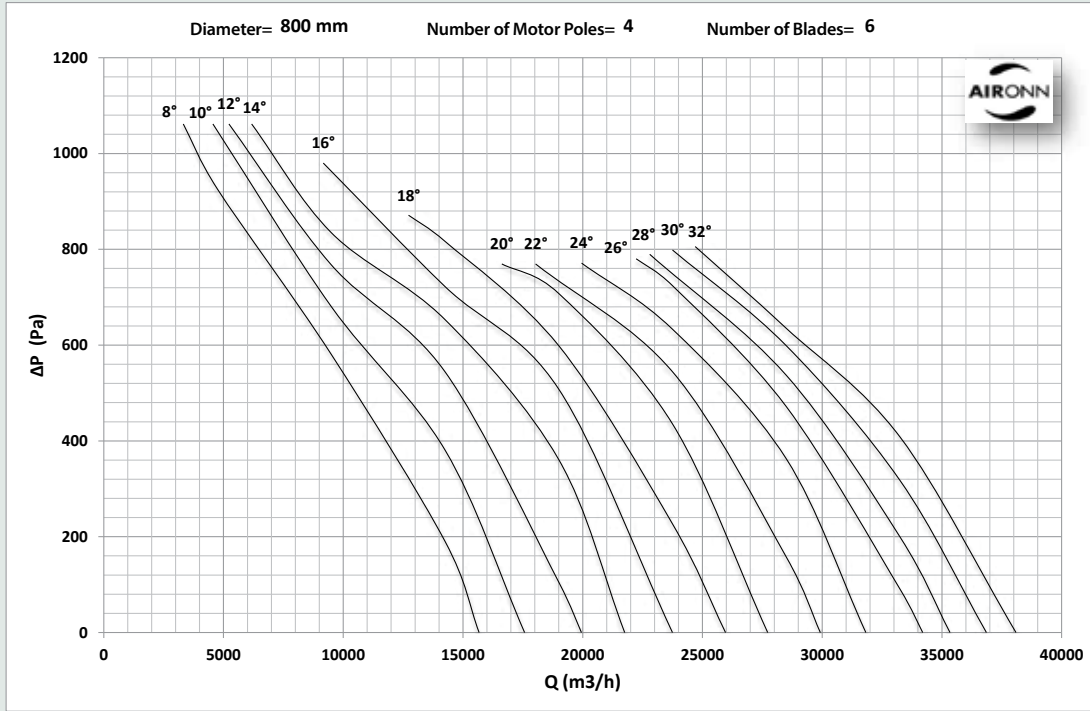



# Twin Spindle Axial Type Smoke Exhaust Fan Series

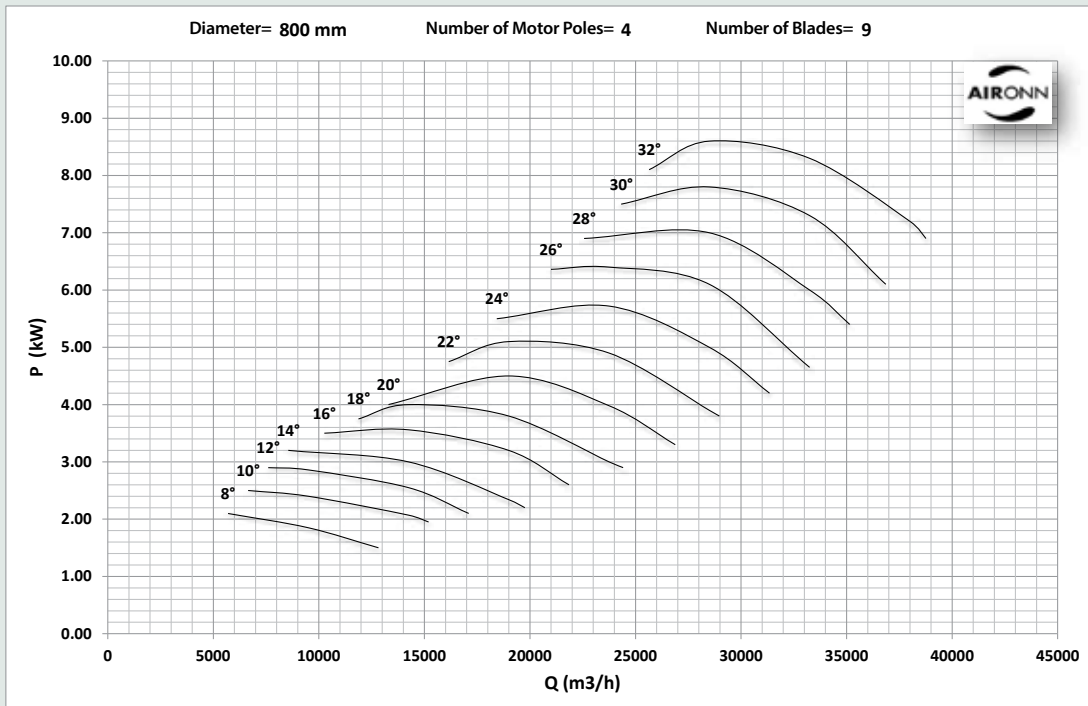
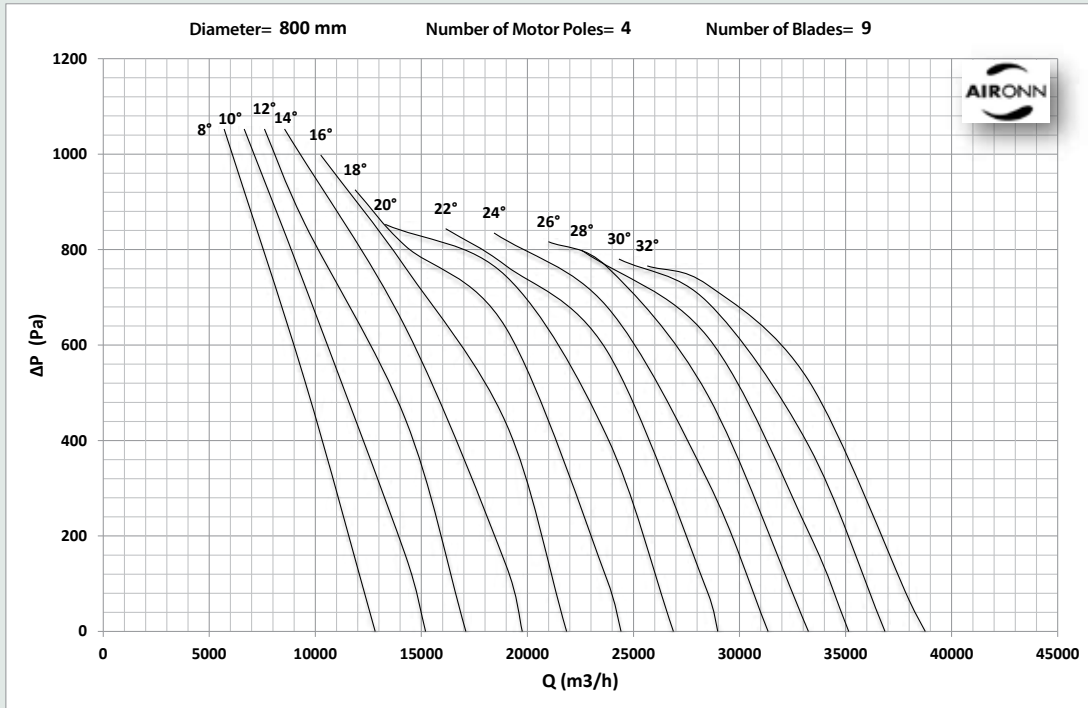

# Twin Spindle Axial Type Smoke Exhaust Fan Series

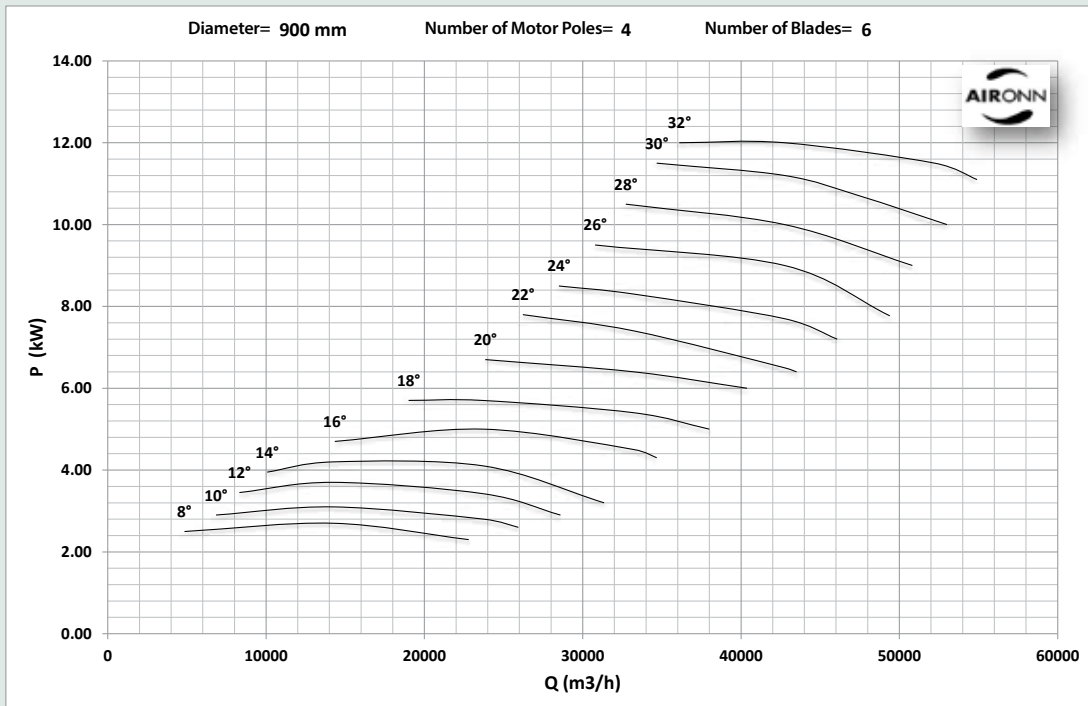
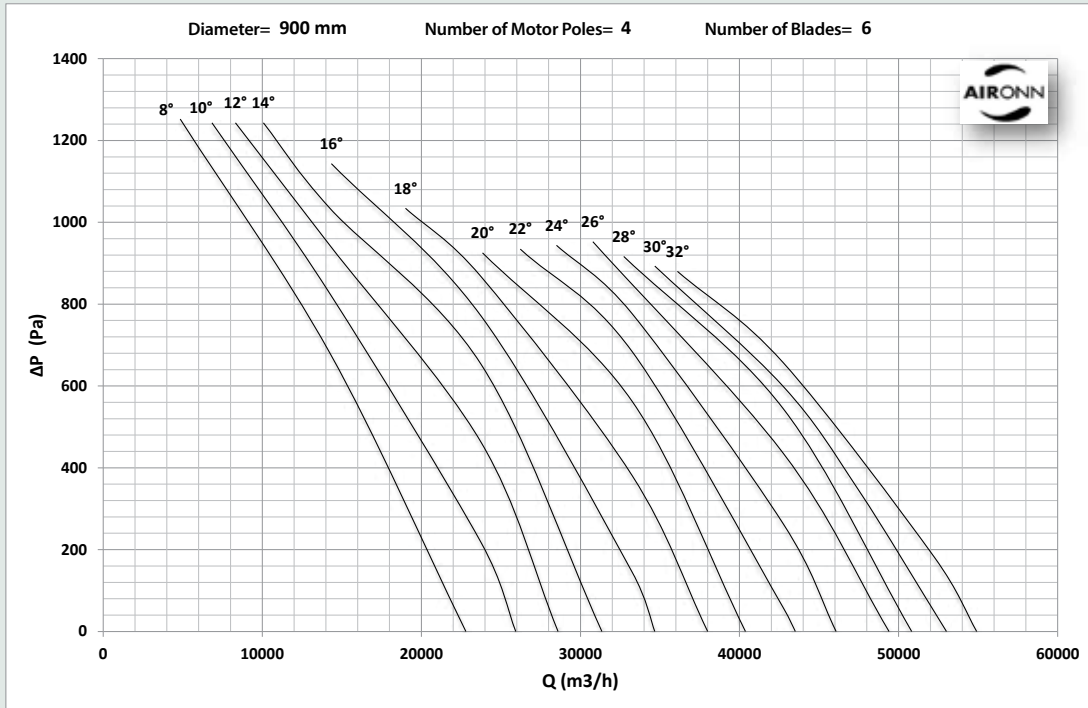

# Twin Spindle Axial Type Smoke Exhaust Fan Series

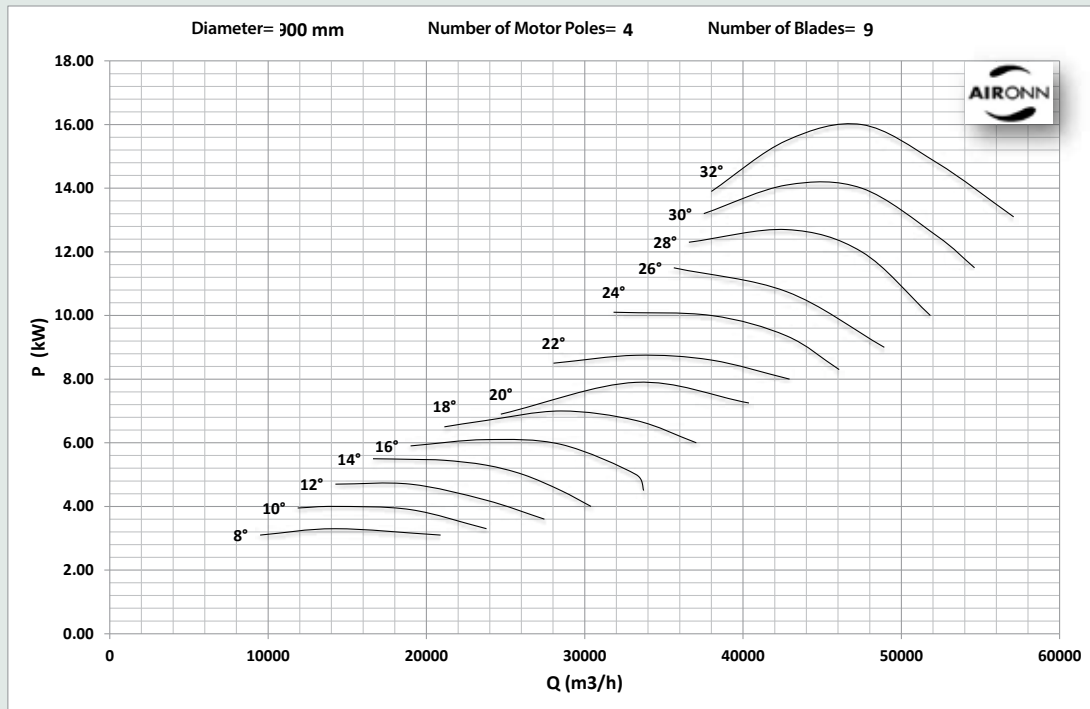
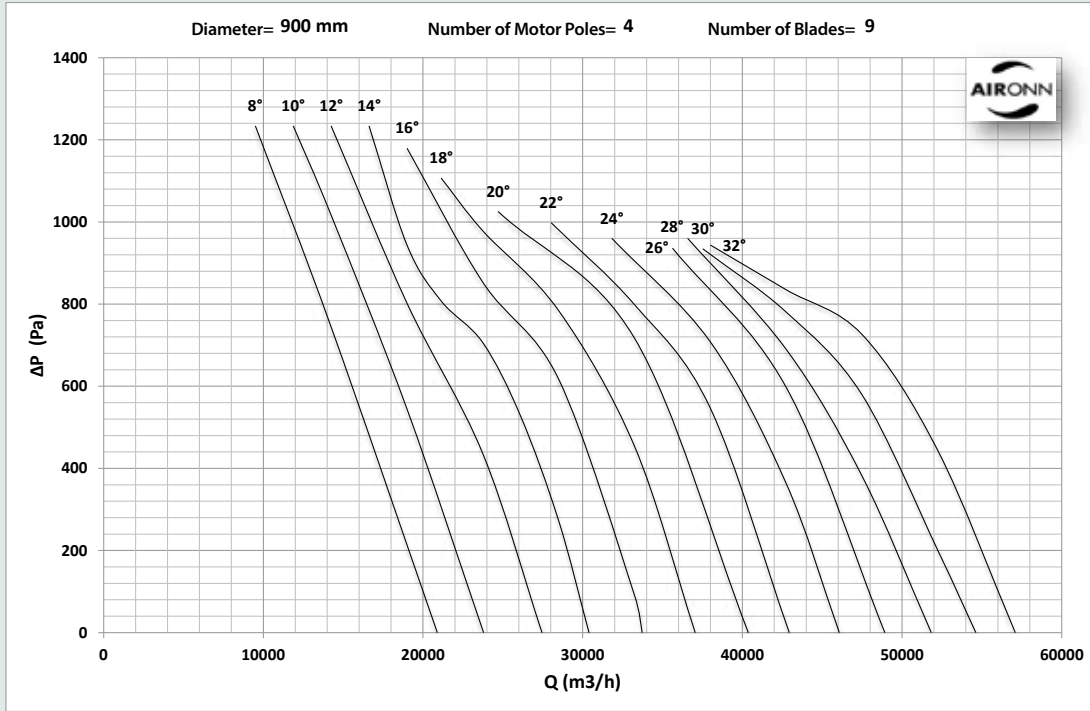

# Twin Spindle Axial Type Smoke Exhaust Fan Series

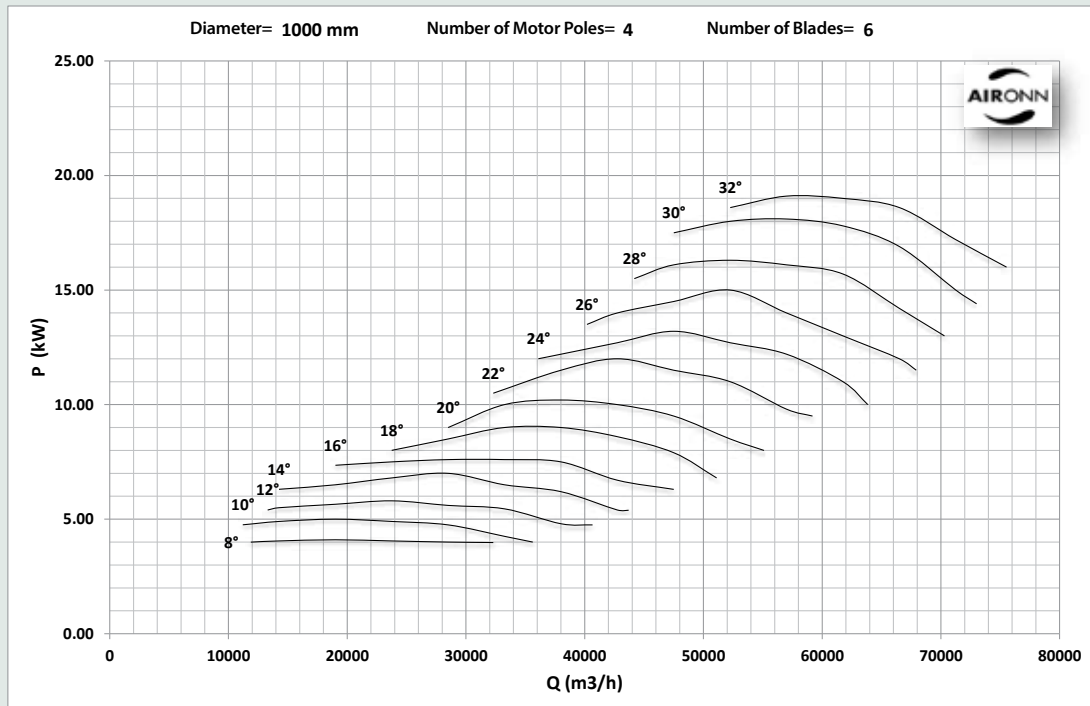
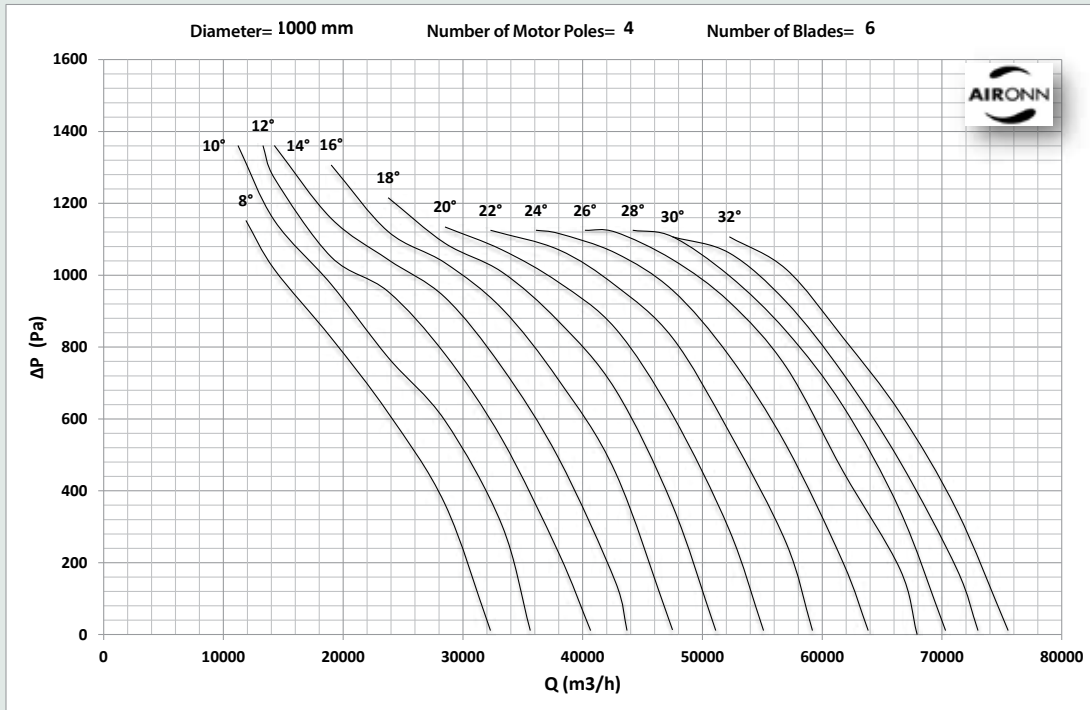

# Twin Spindle Axial Type Smoke Exhaust Fan Series

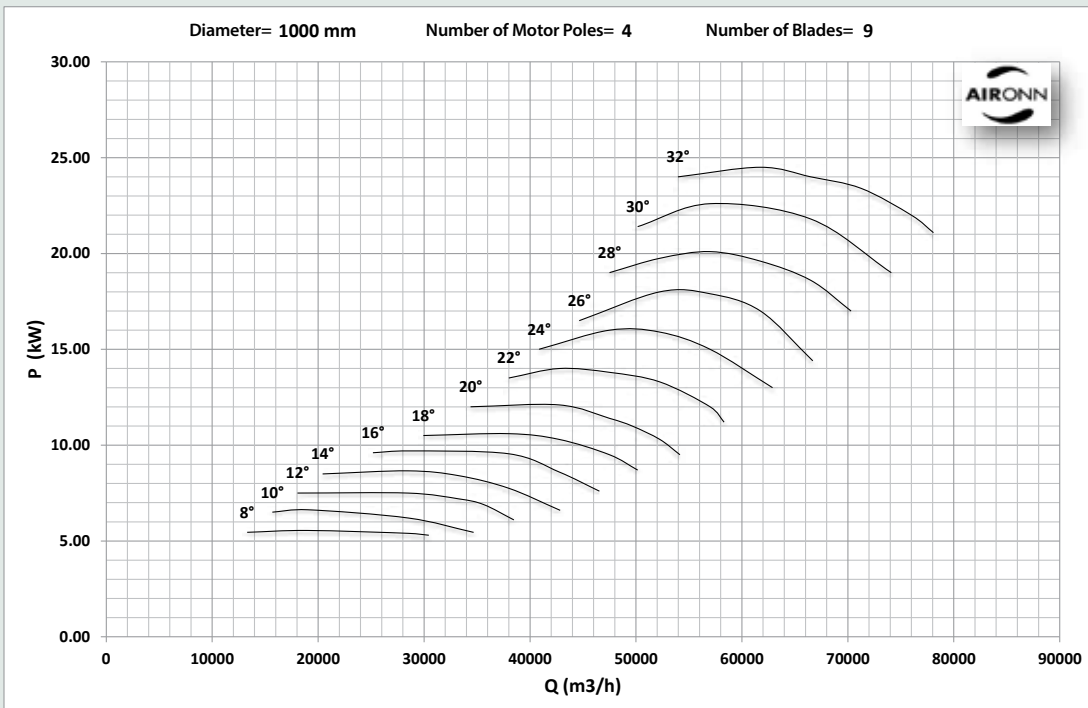
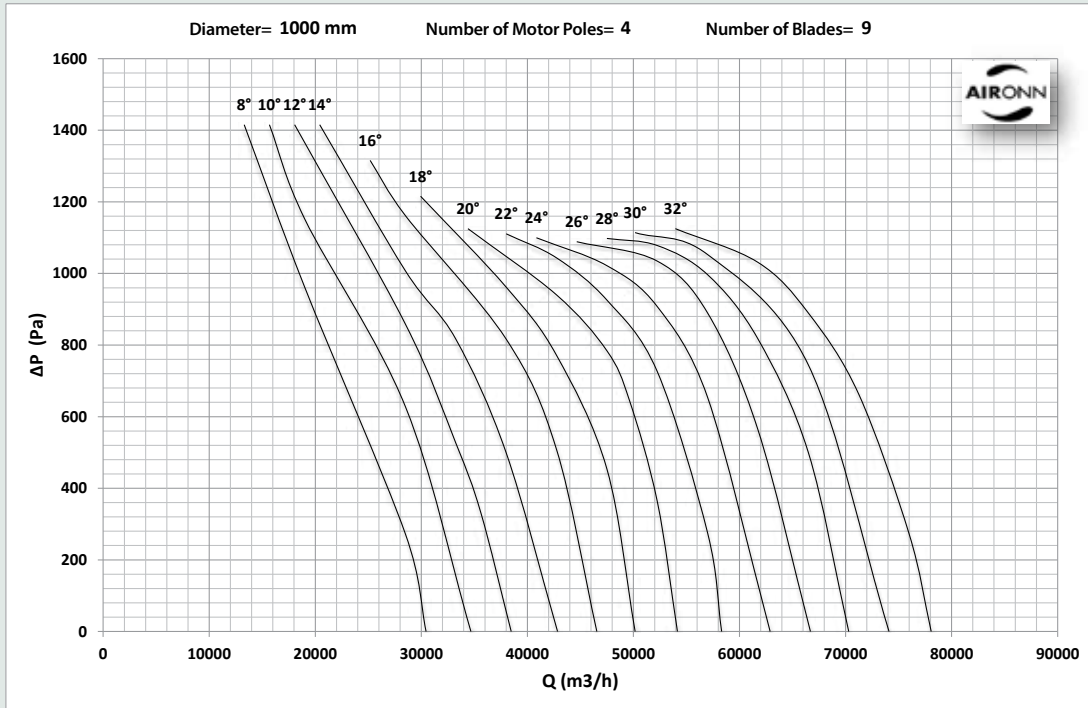

# Twin Spindle Axial Type Smoke Exhaust Fan Series

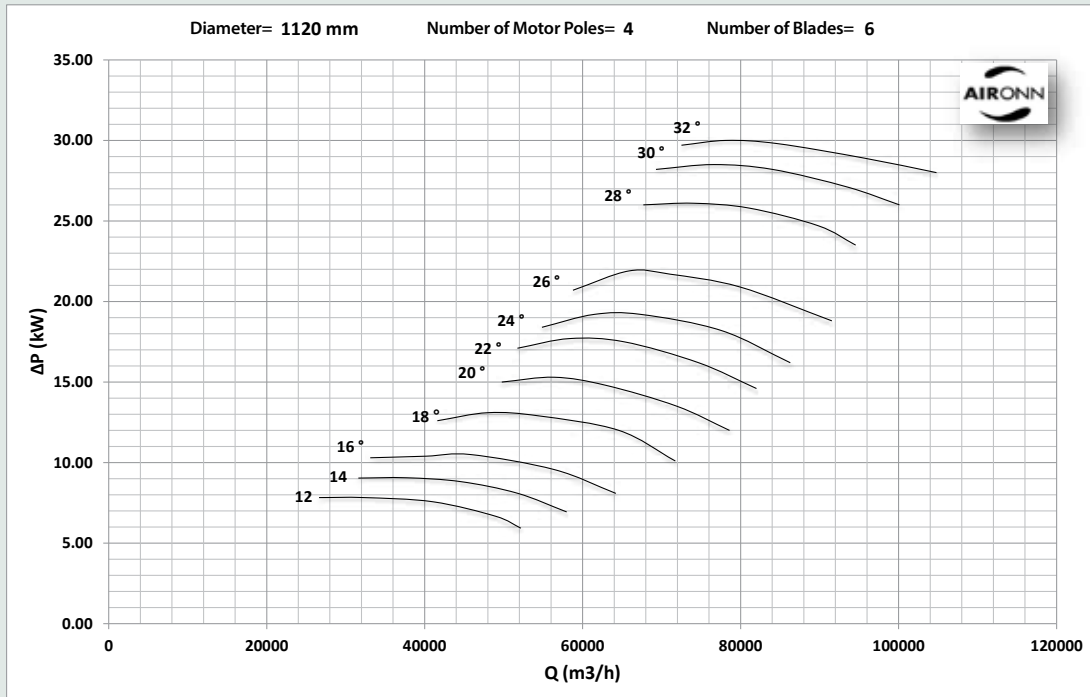
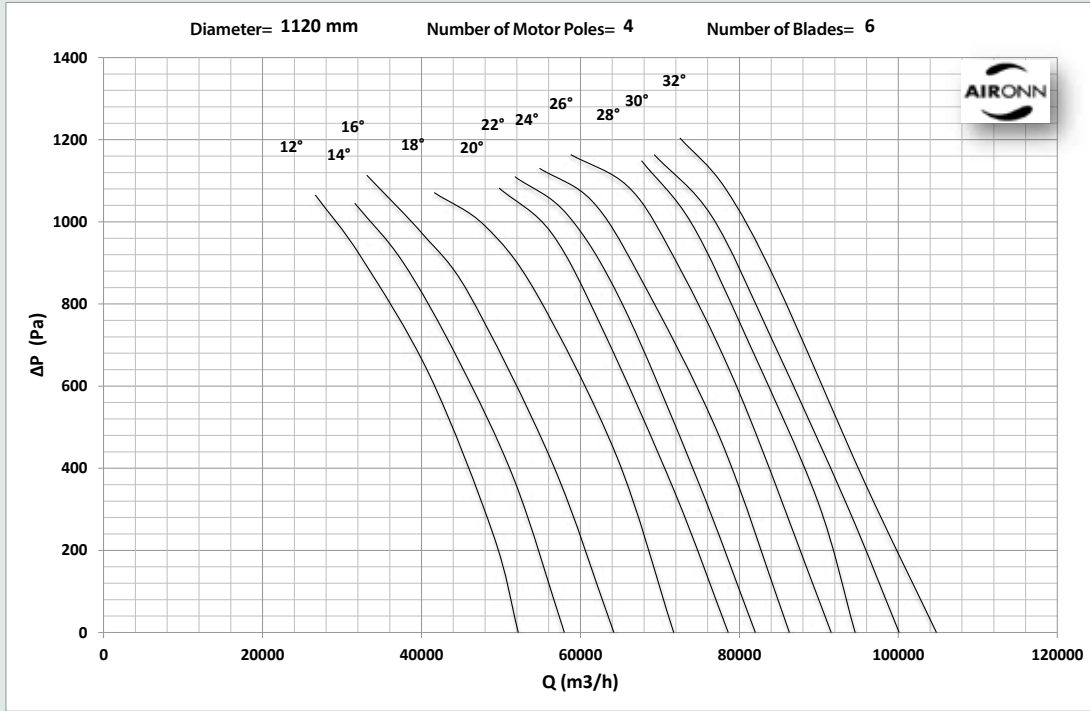

# Twin Spindle Axial Type Smoke Exhaust Fan Series

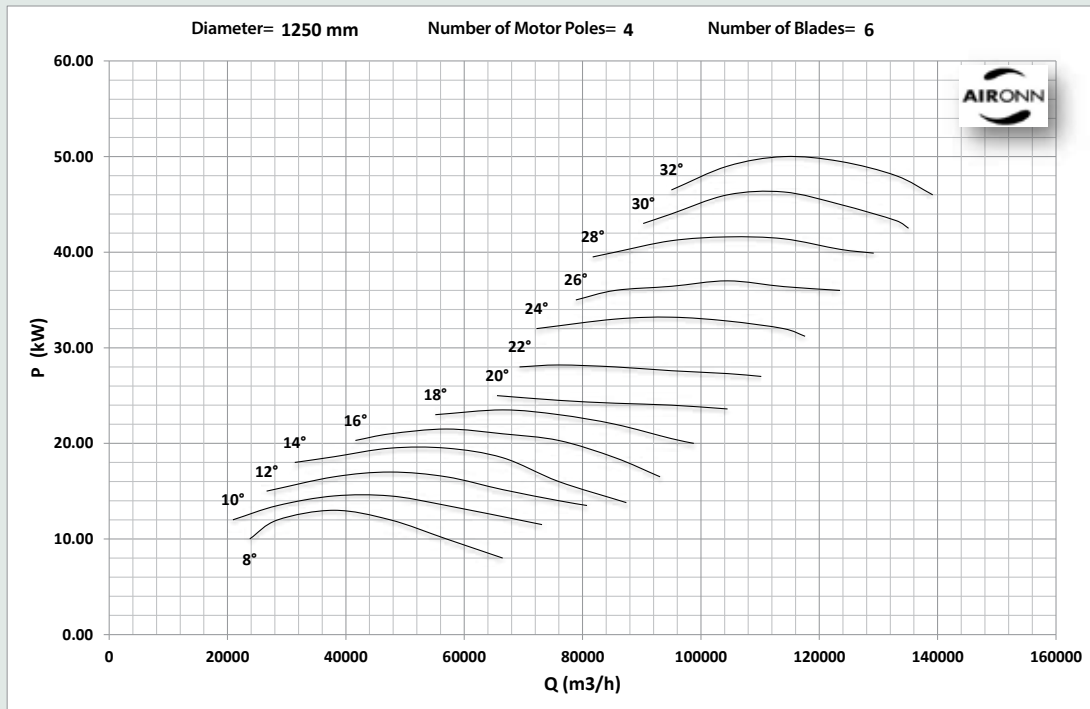
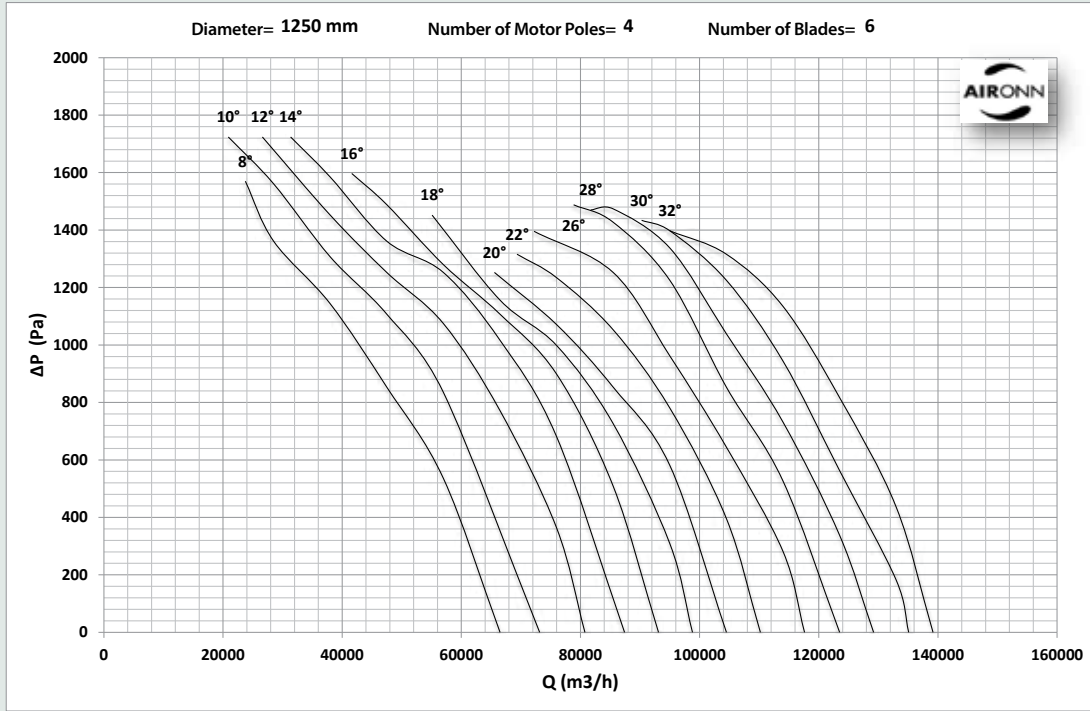

# Twin Spindle Axial Type Smoke Exhaust Fan Series

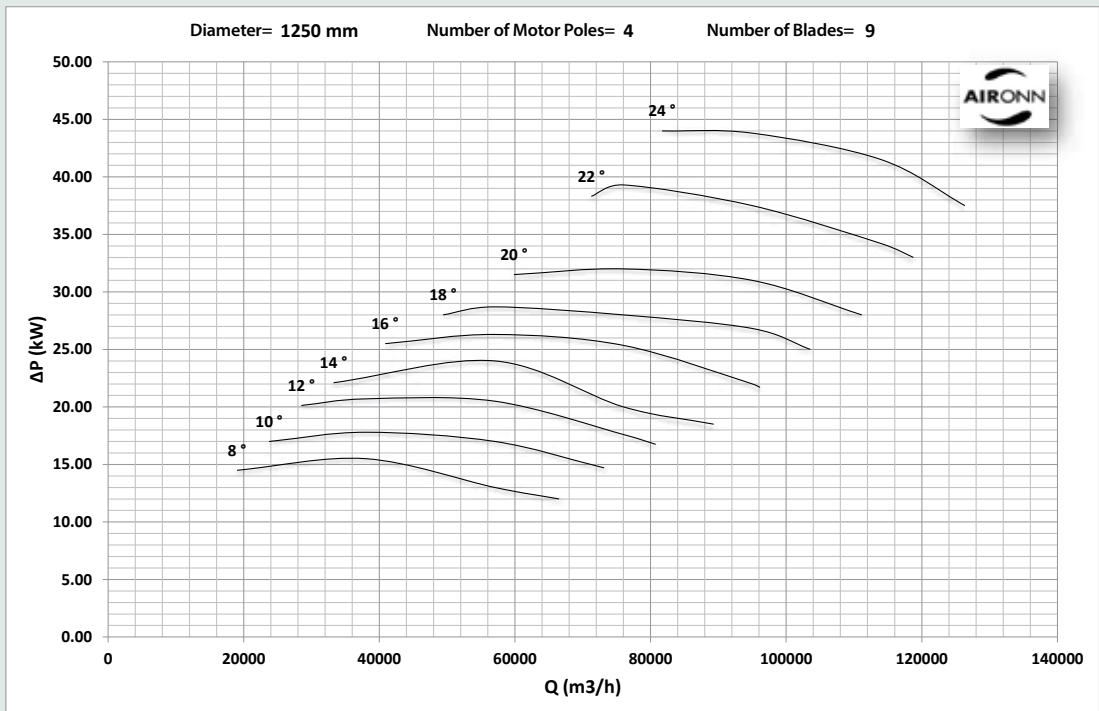
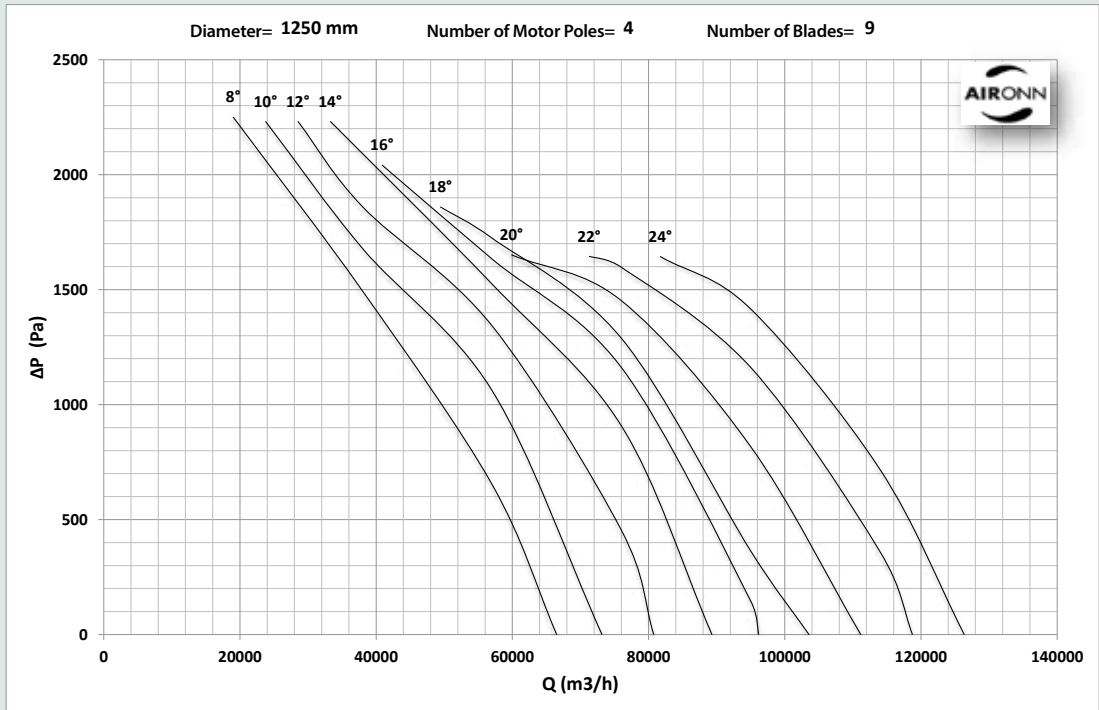



# Twin Spindle Axial Type Smoke Exhaust Series

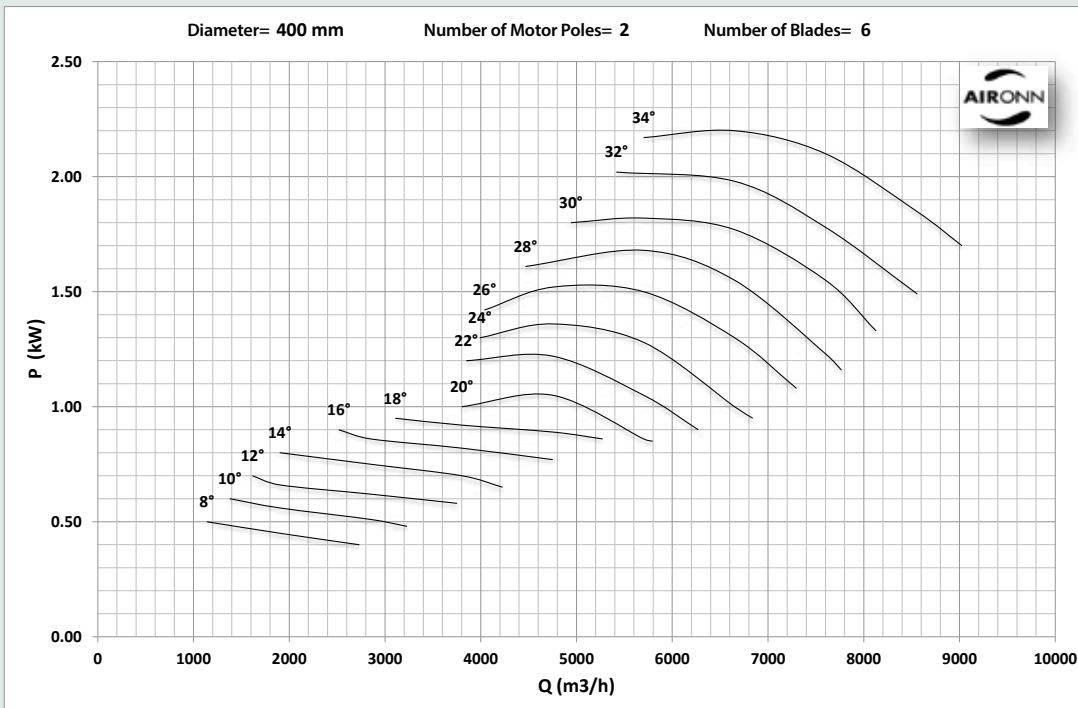
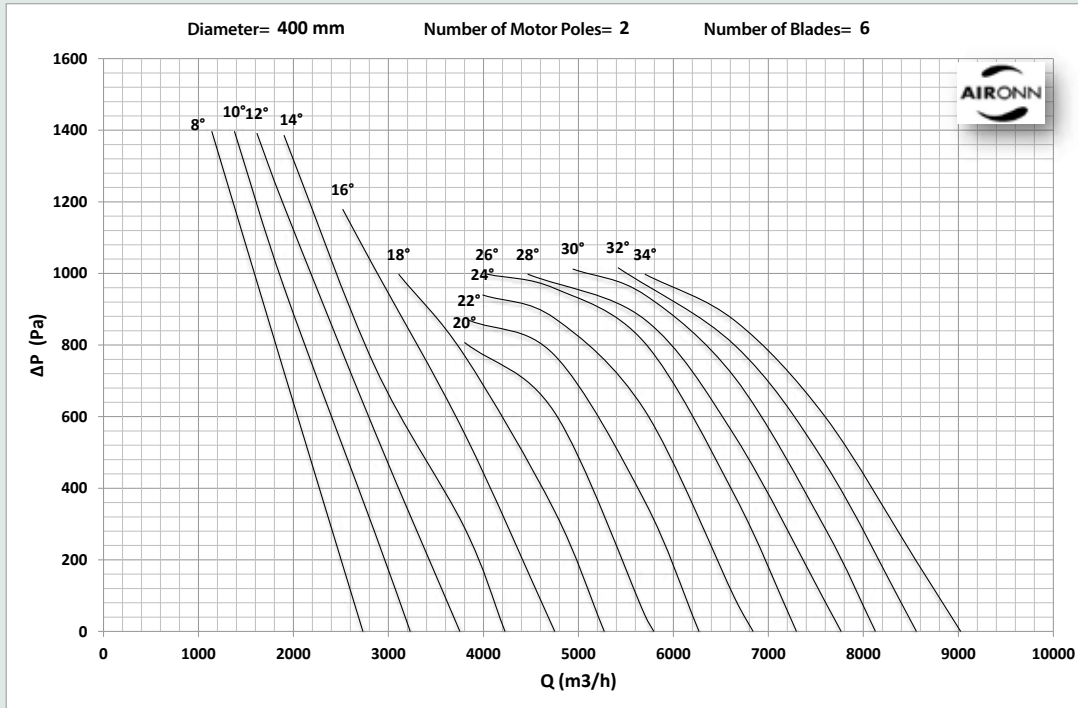

# Twin Spindle Axial Type Smoke Exhaust Series

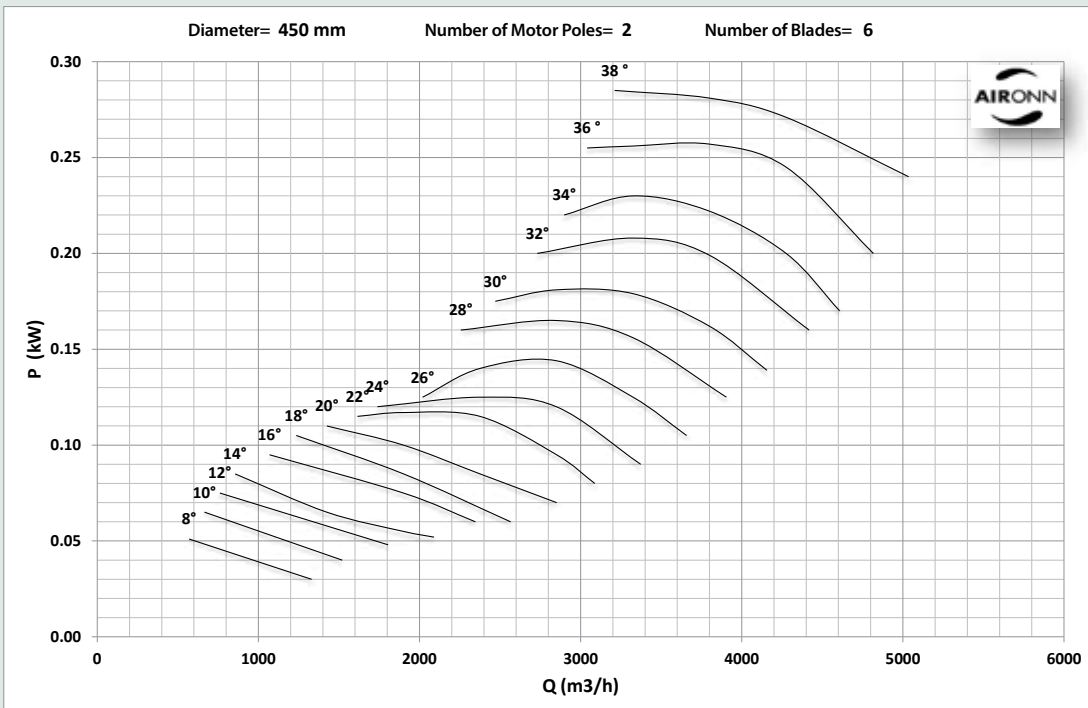
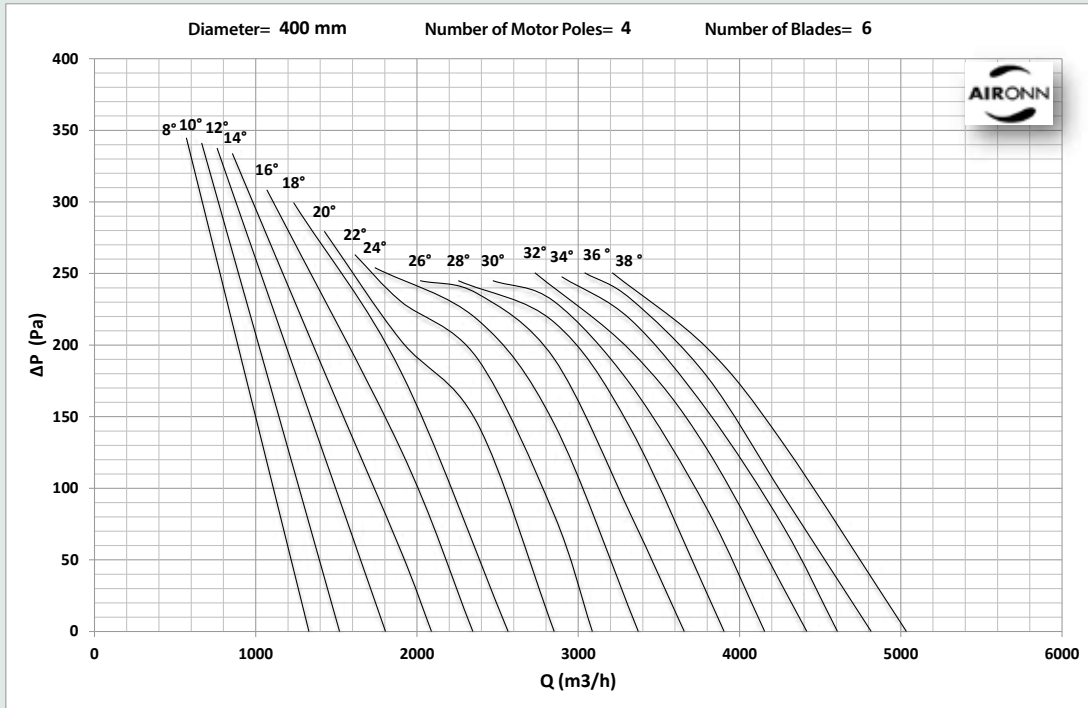

# Twin Spindle Axial Type Smoke Exhaust Series

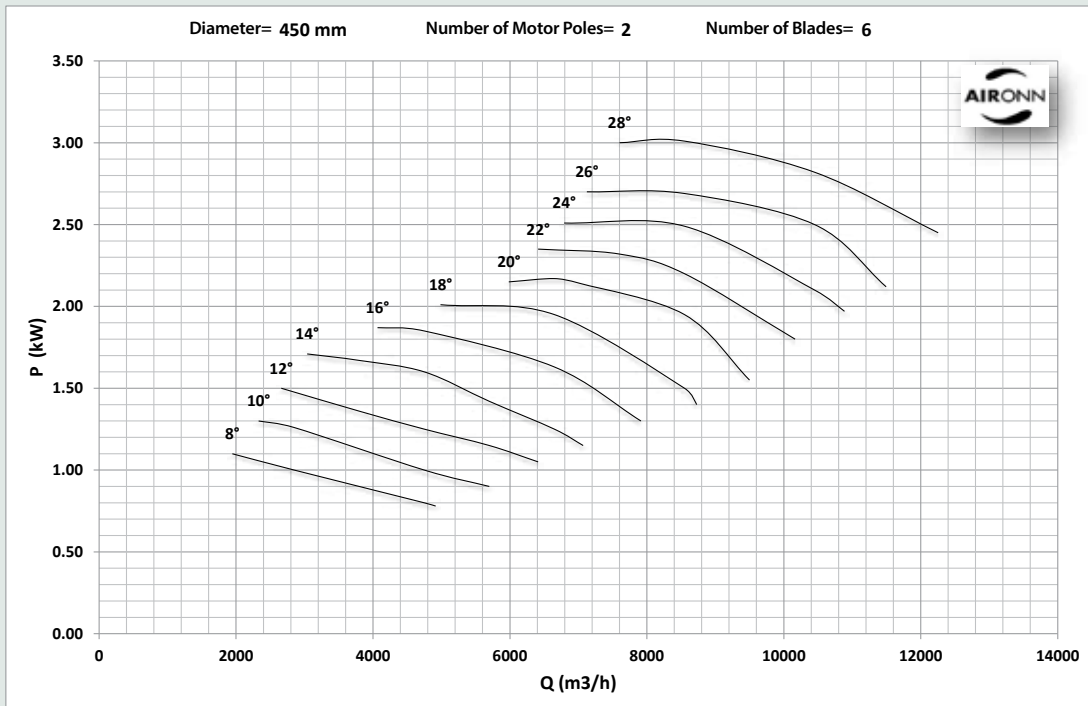
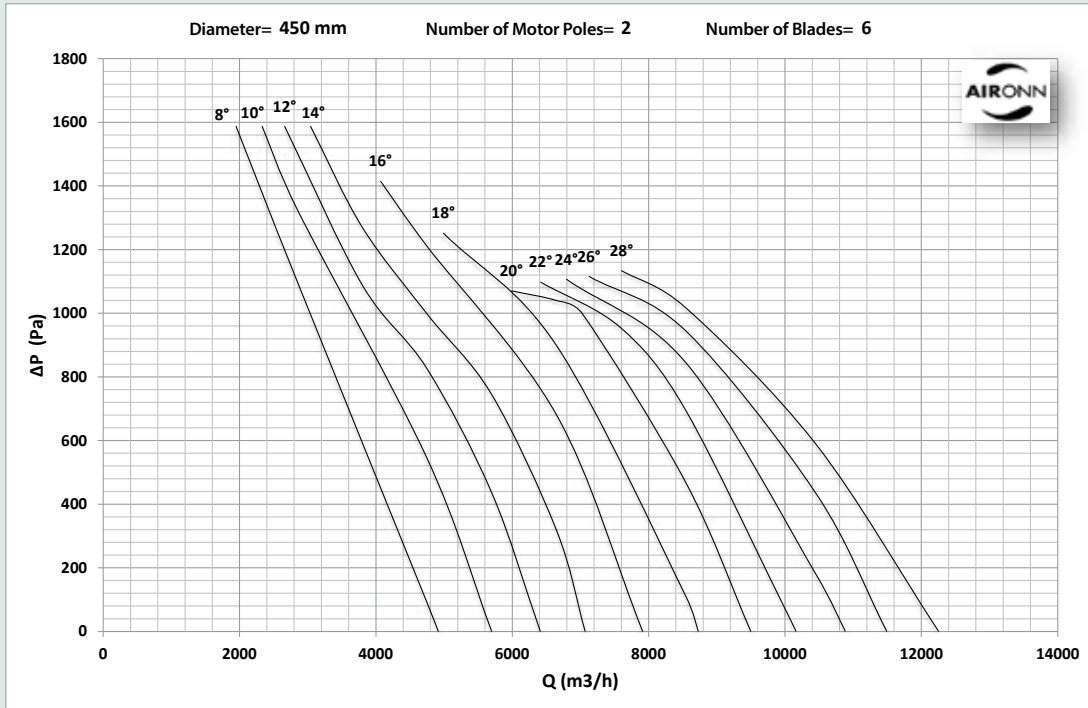

# Twin Spindle Axial Type Smoke Exhaust Series

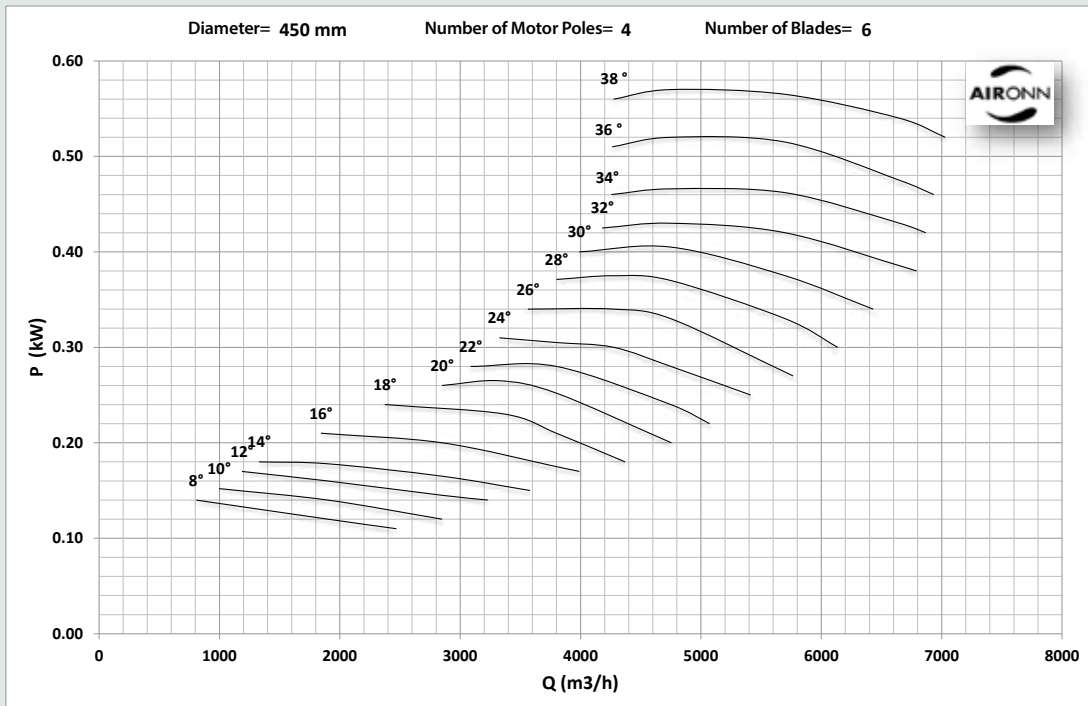
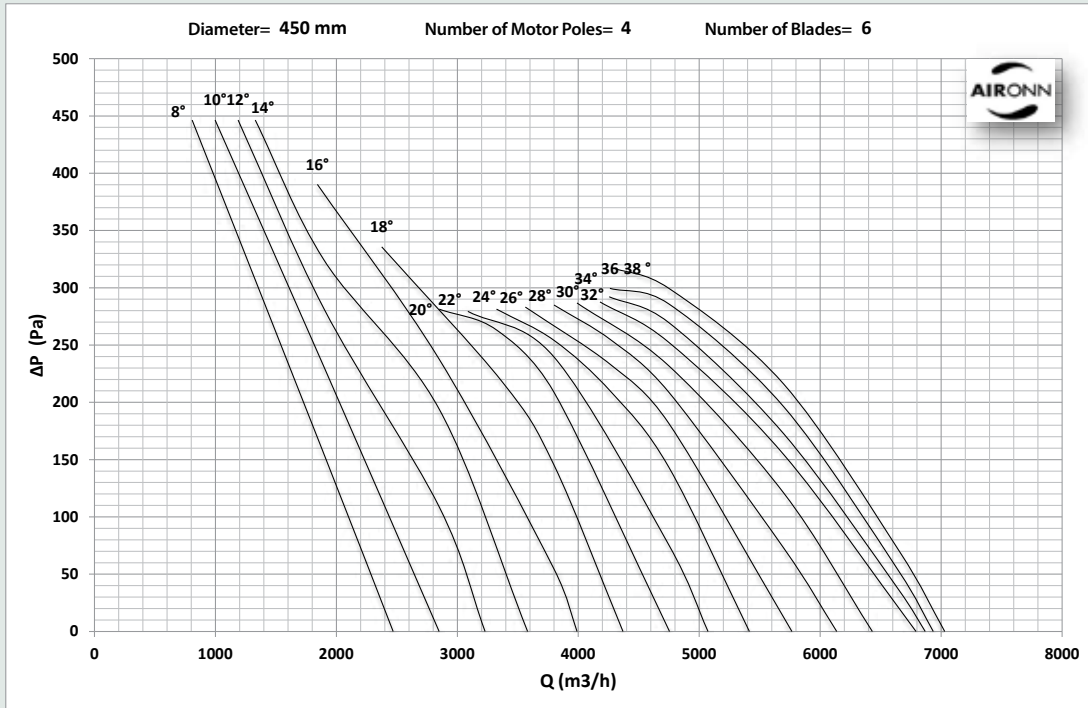

# Twin Spindle Axial Type Smoke Exhaust Series

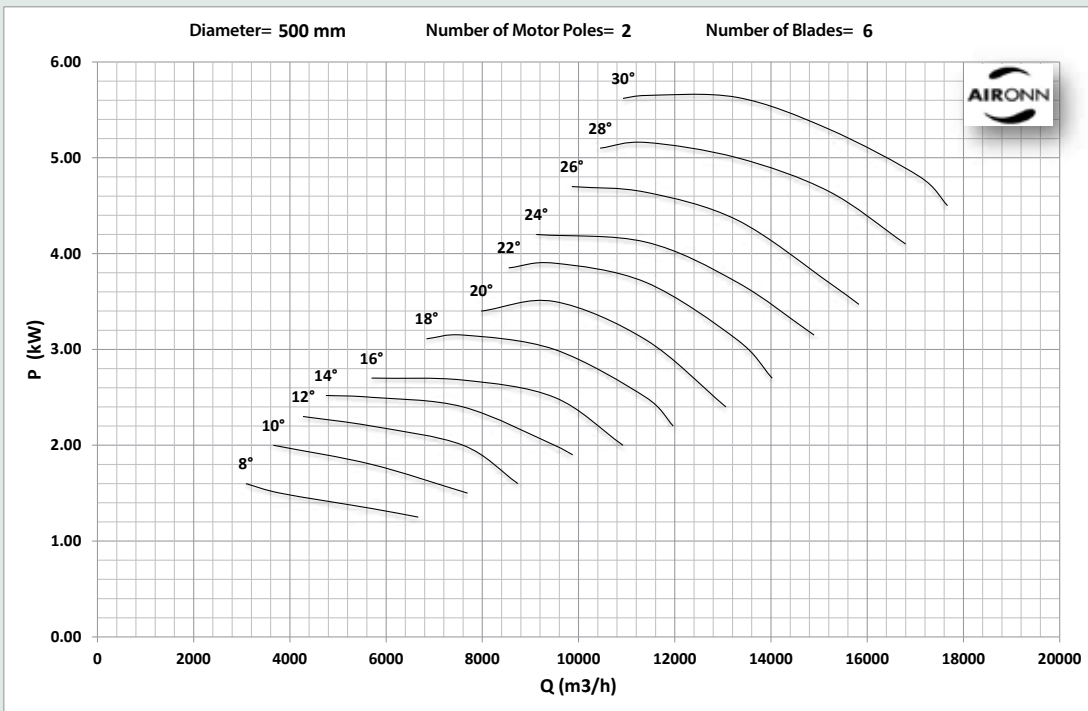
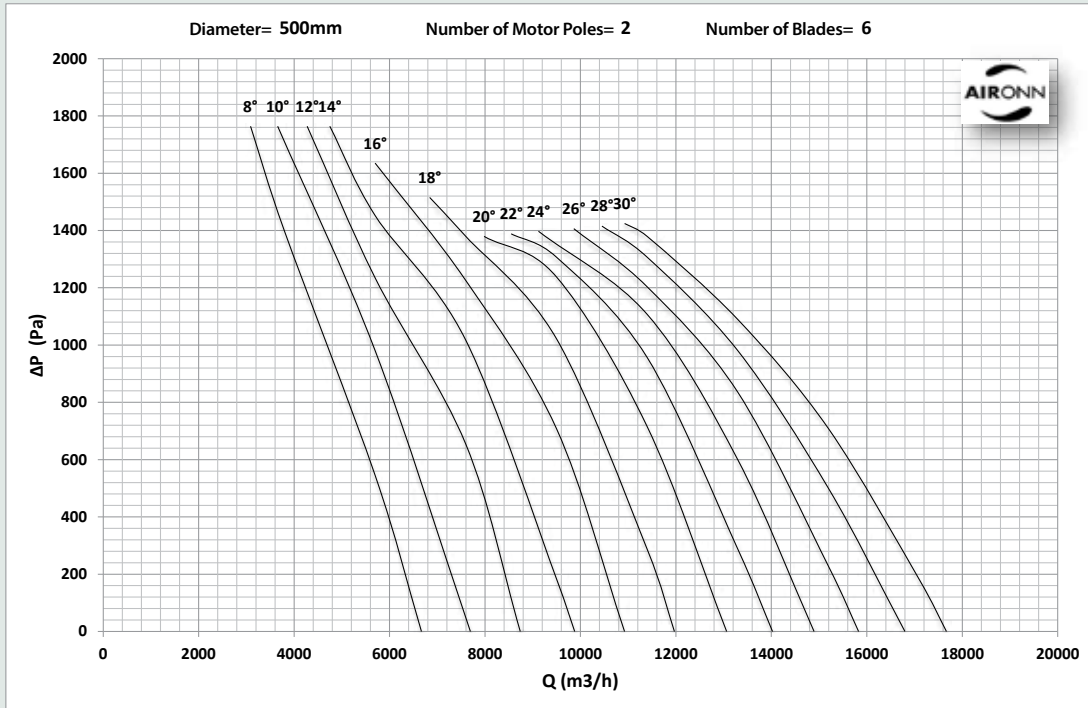

# Twin Spindle Axial Type Smoke Exhaust Series

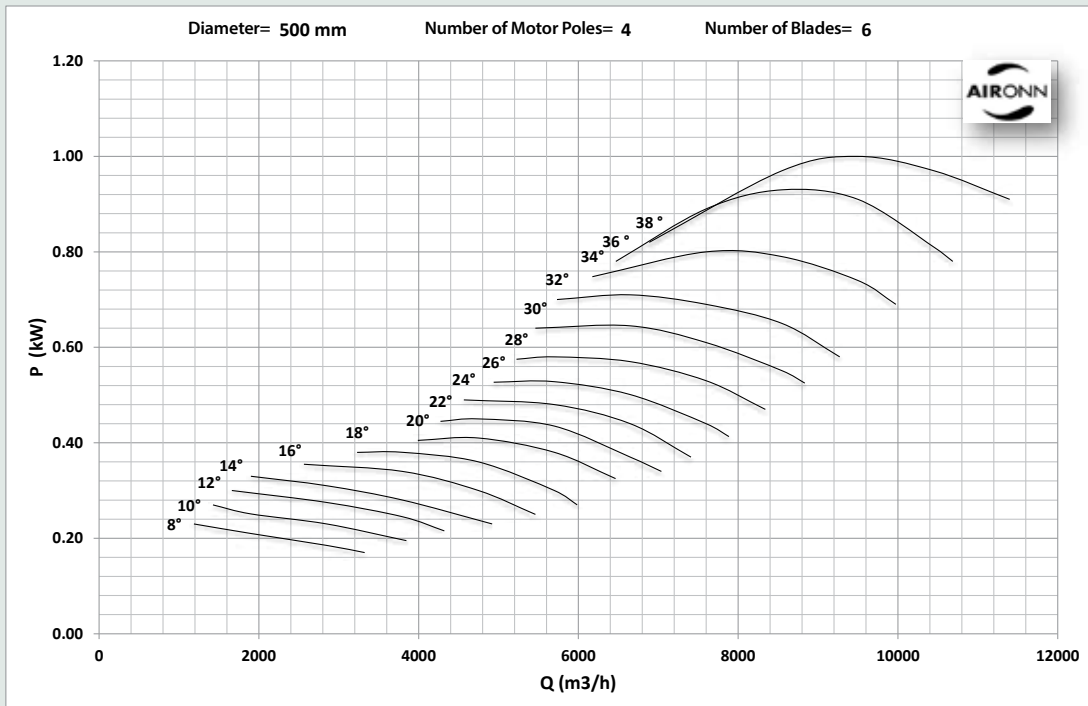
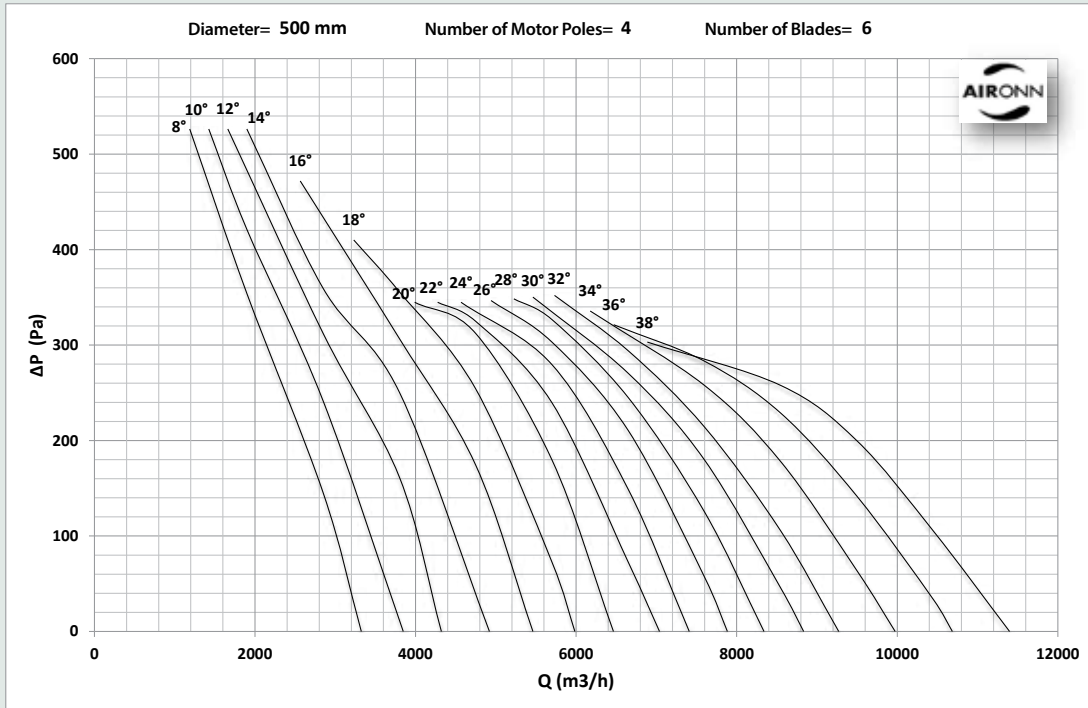

# Twin Spindle Axial Type Smoke Exhaust Series

**F400**  
400°C/2h

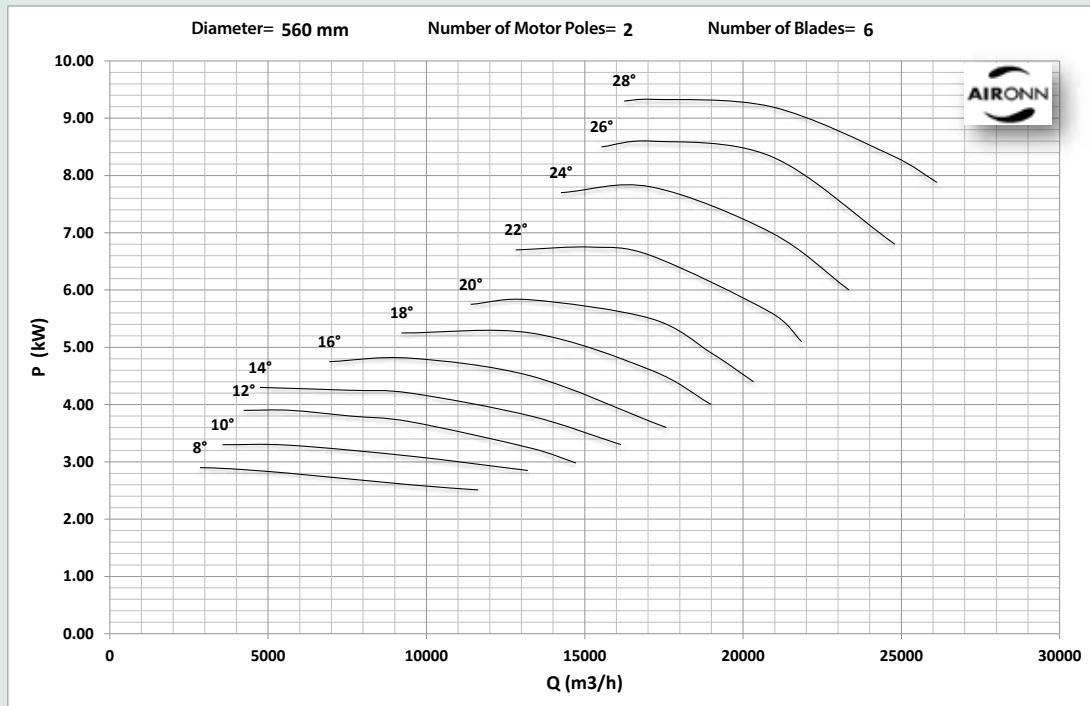
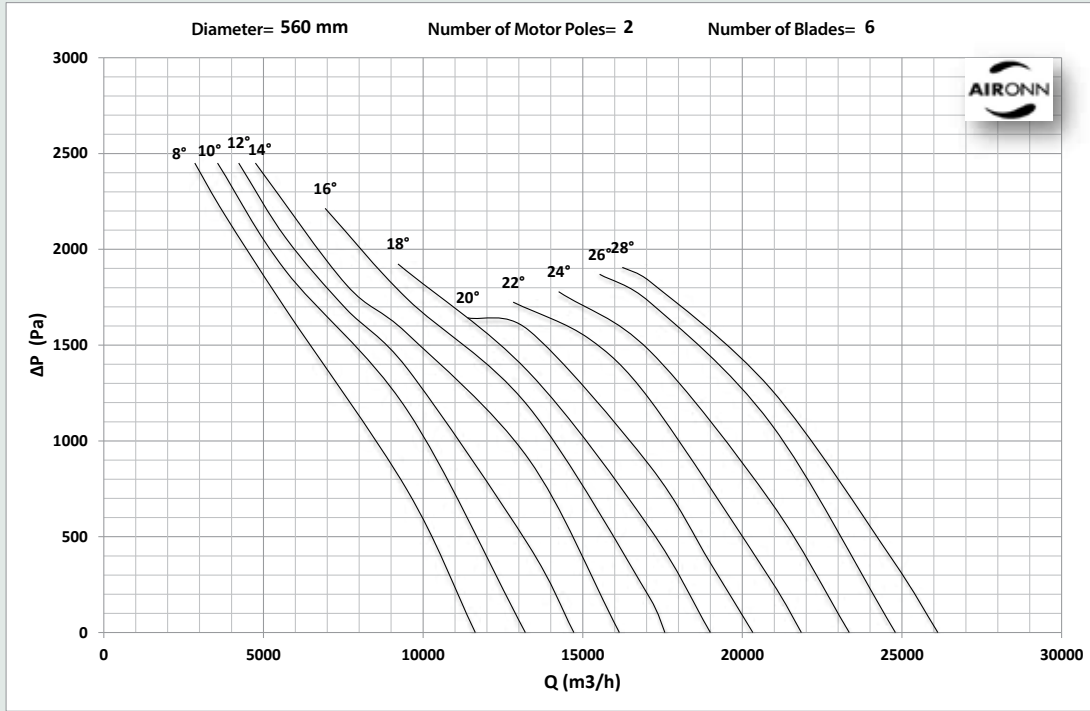

# Twin Spindle Axial Type Smoke Exhaust Series

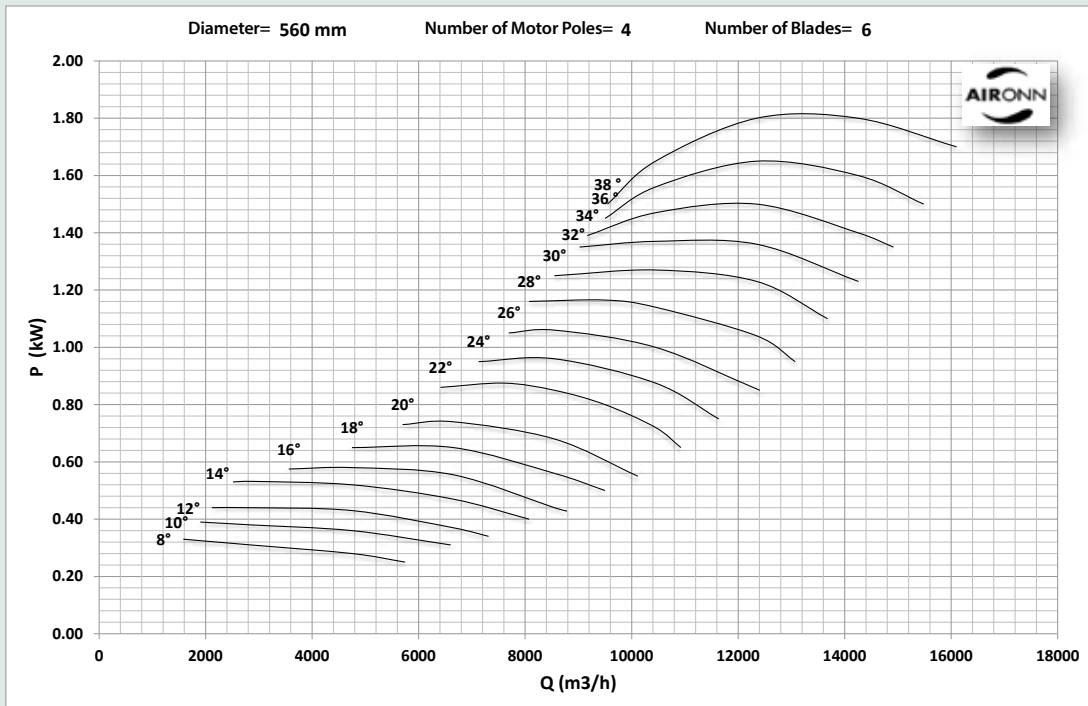
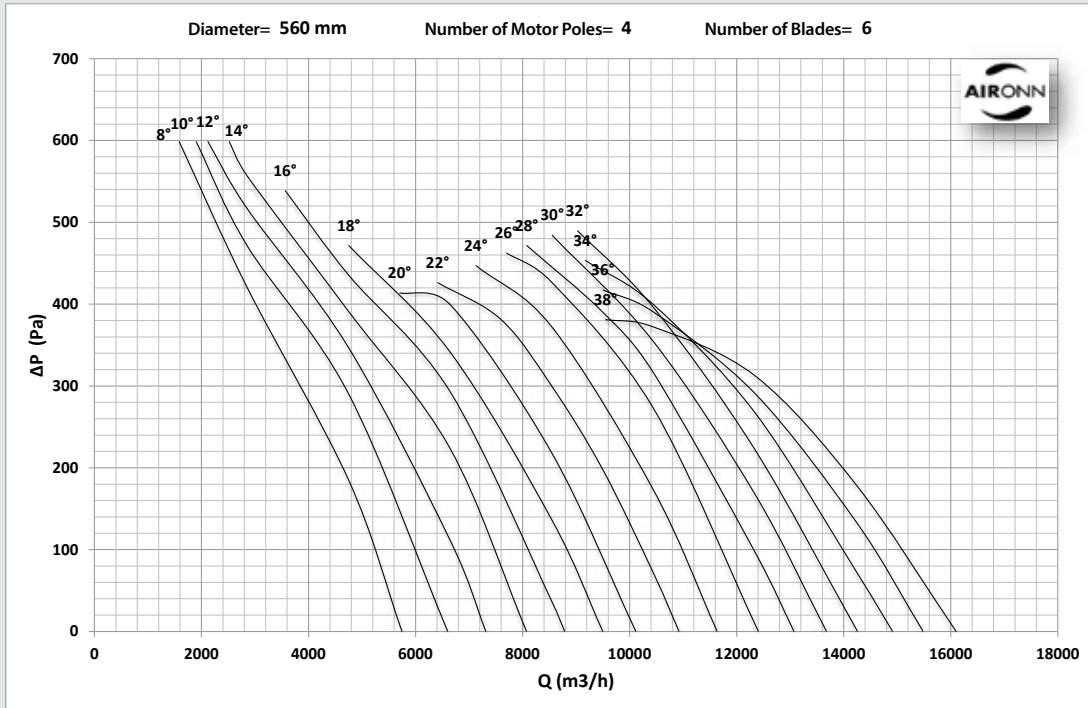



# Twin Spindle Axial Type Smoke Exhaust Series

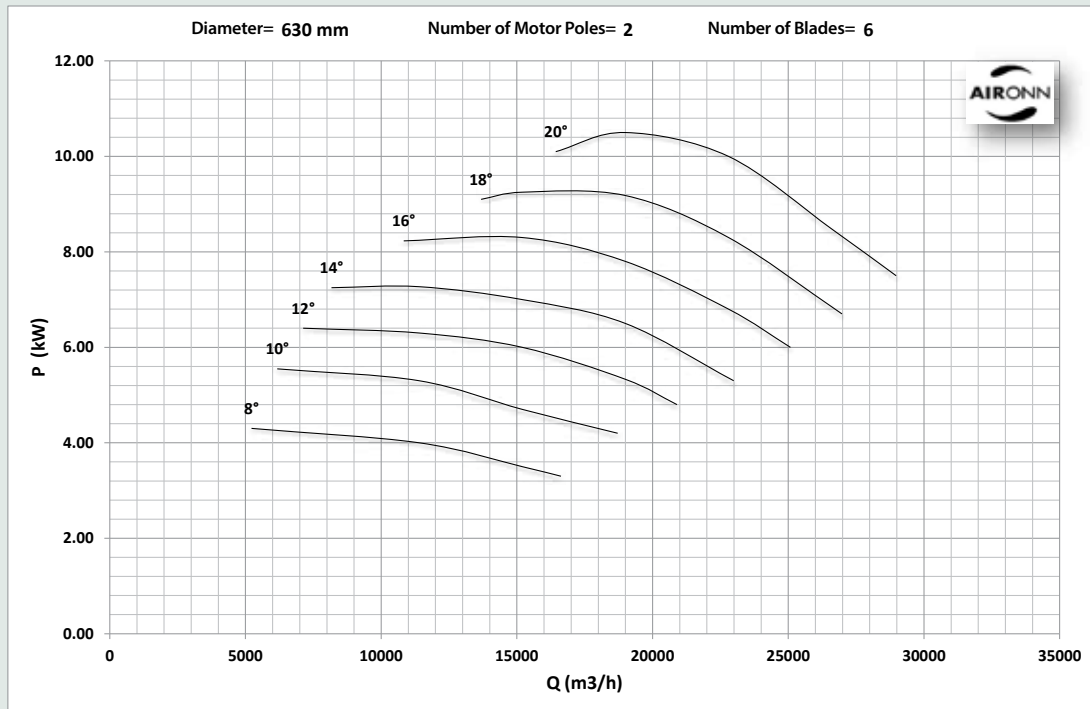
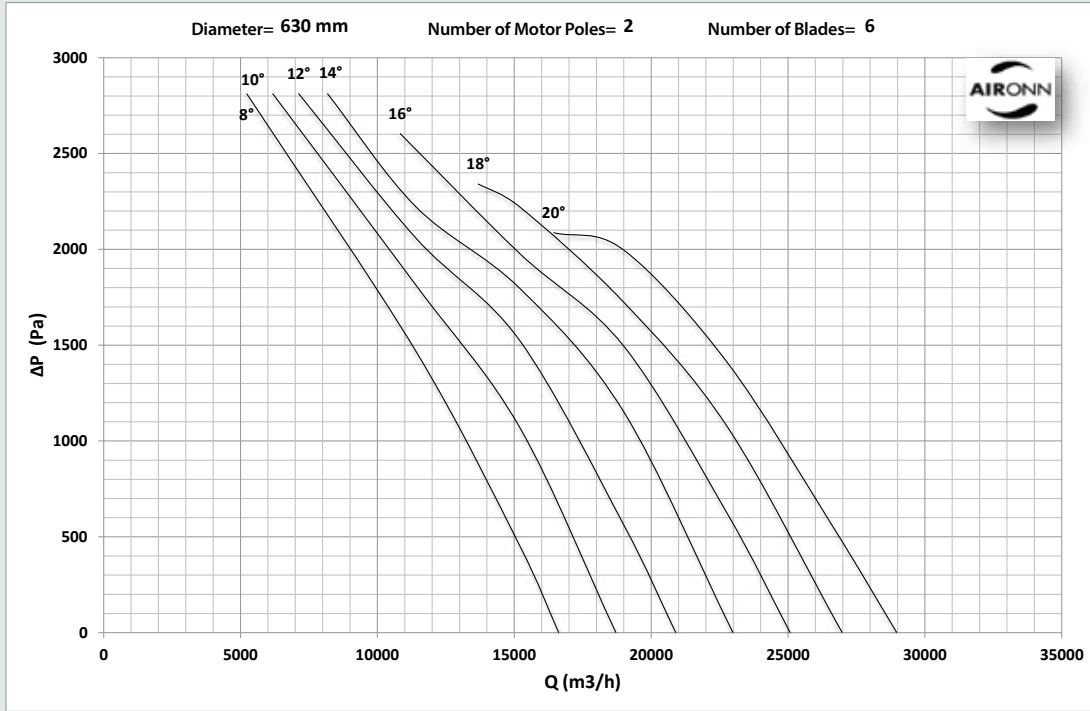

# Twin Spindle Axial Type Smoke Exhaust Series

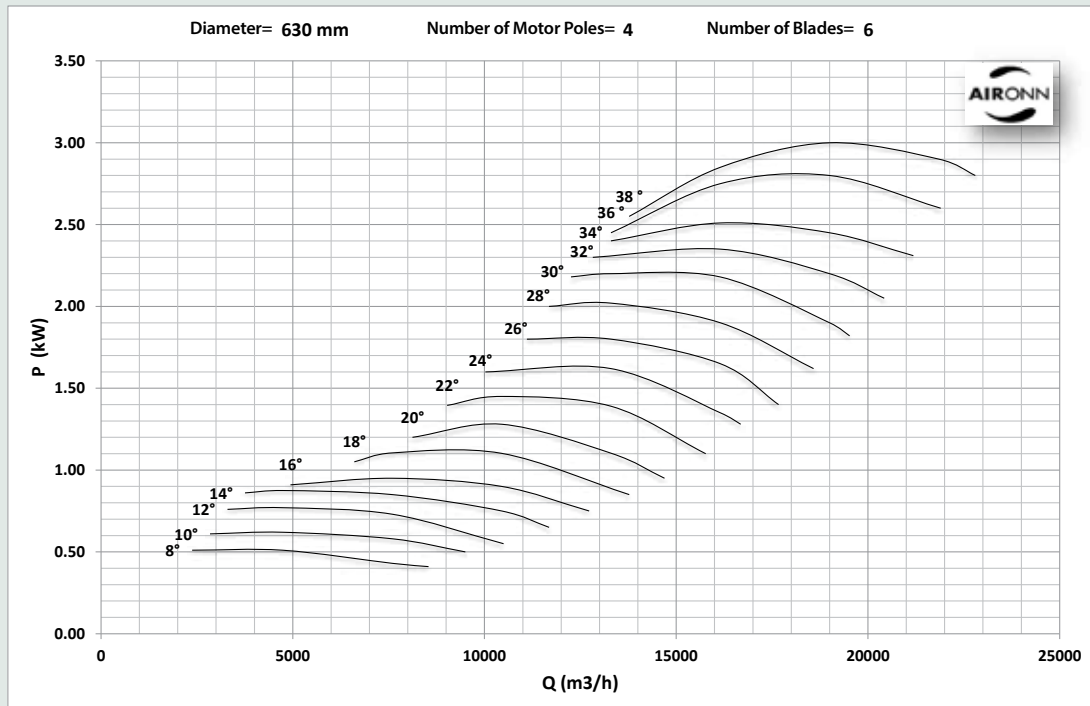
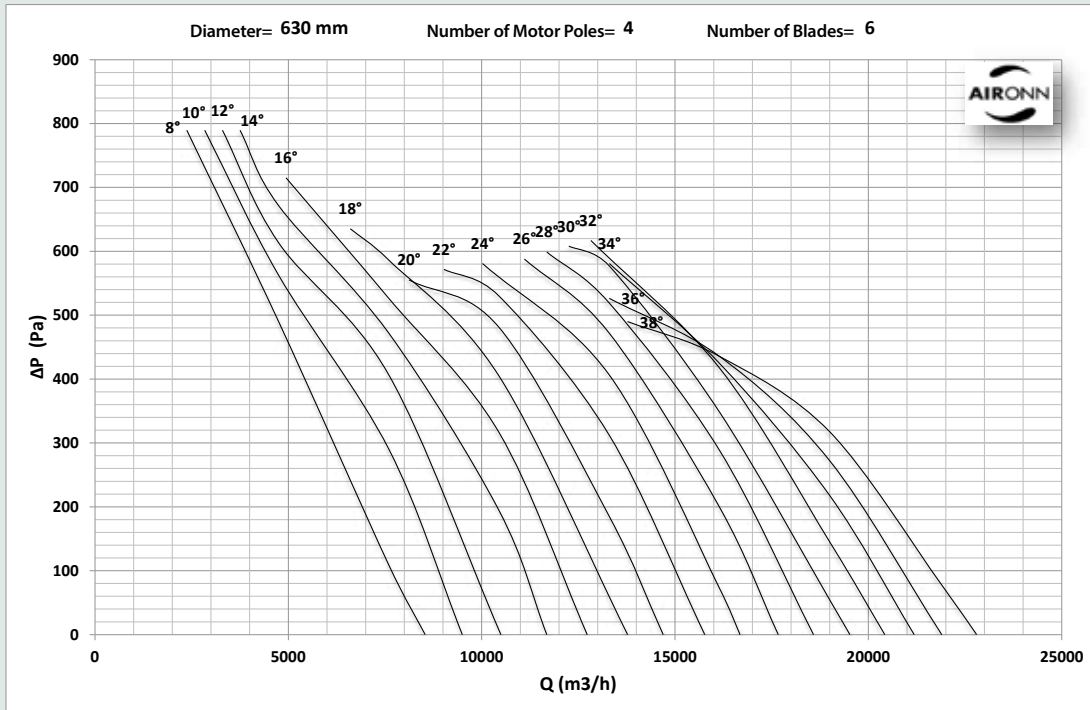

# Twin Spindle Axial Type Smoke Exhaust Series

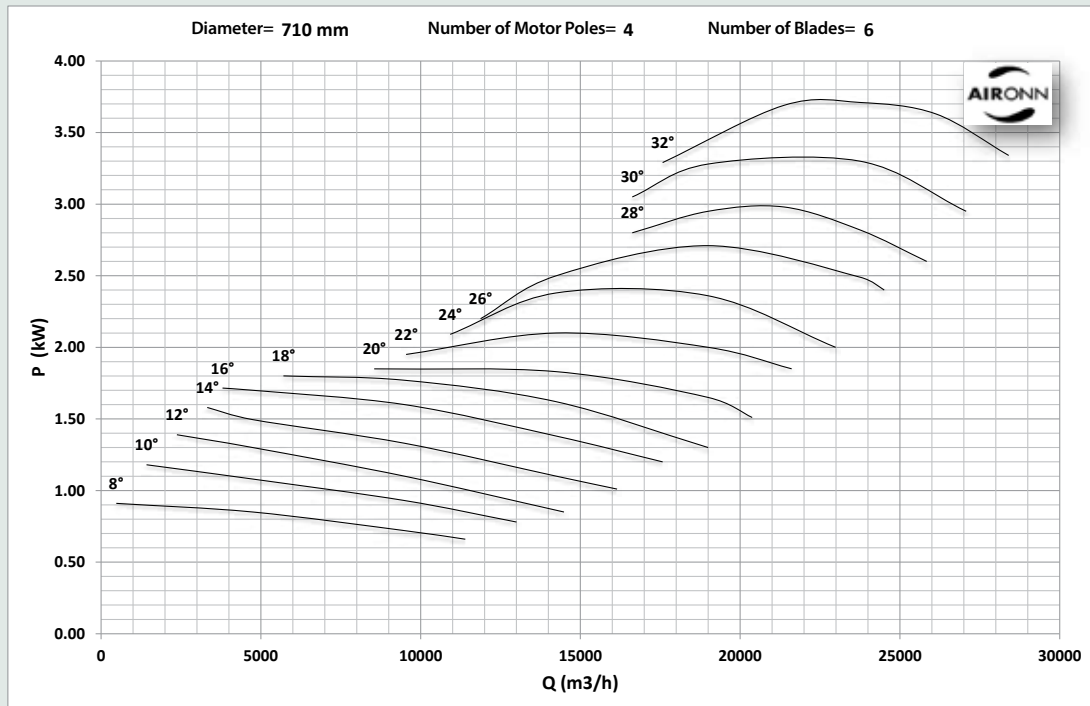
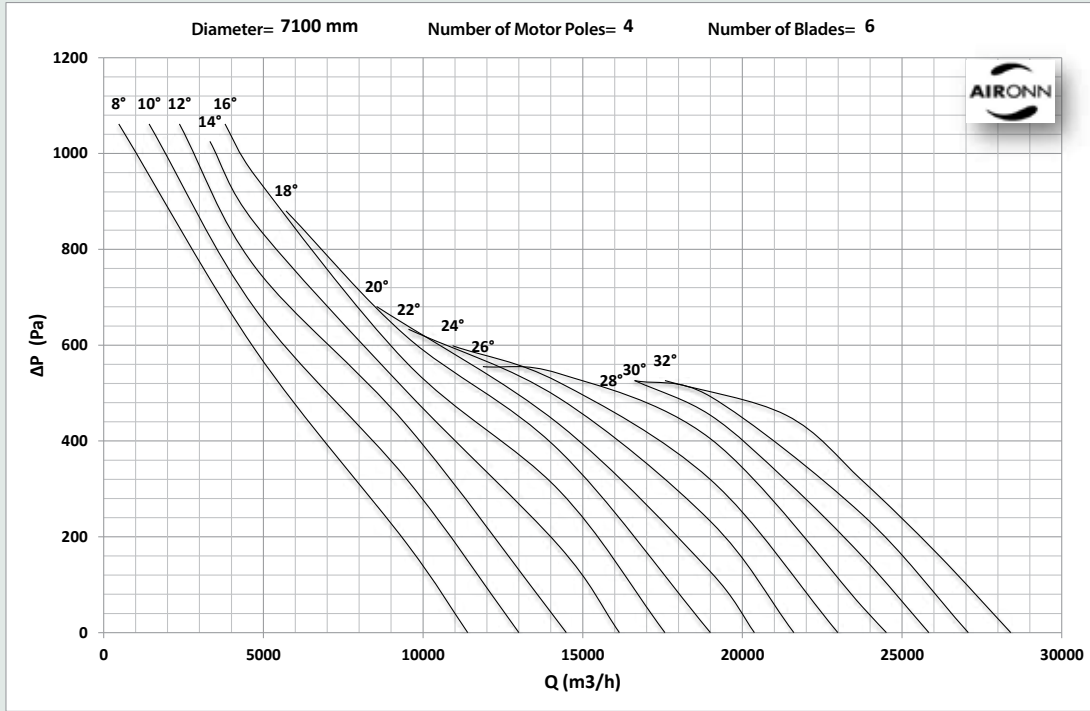

# Twin Spindle Axial Type Smoke Exhaust Series

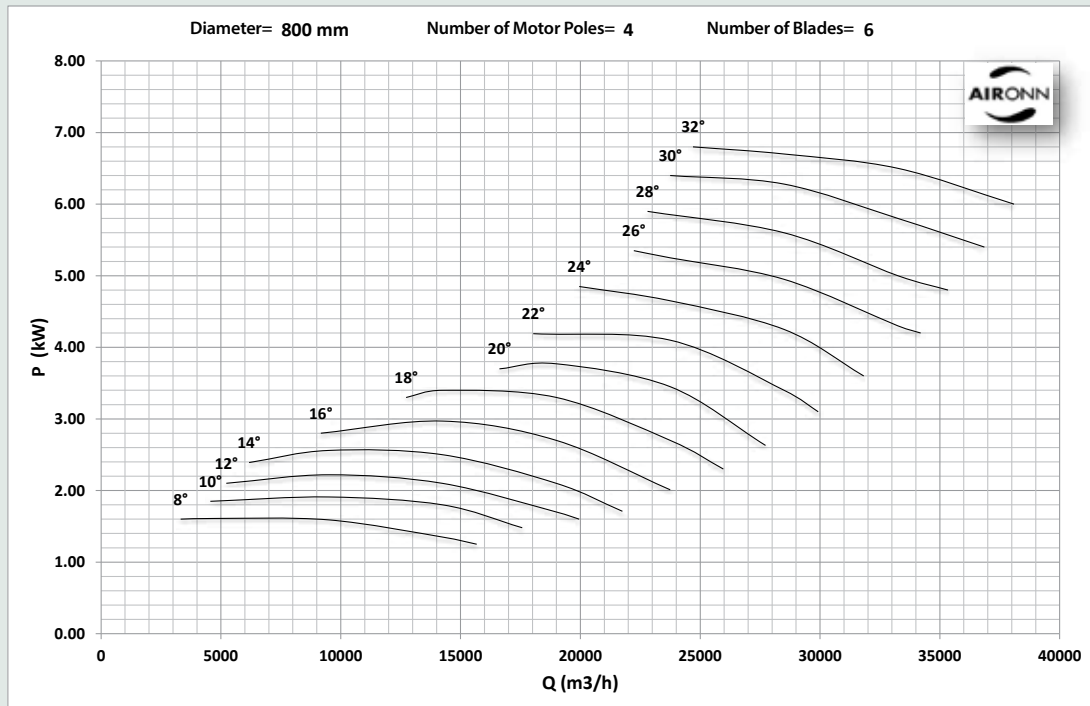
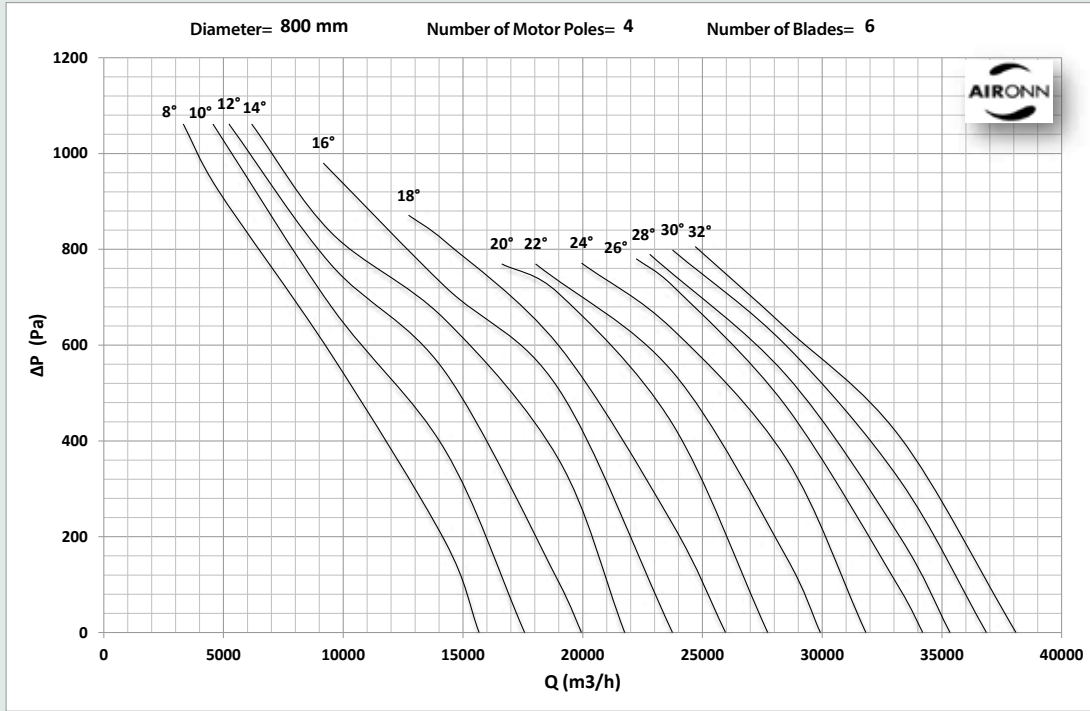

# Twin Spindle Axial Type Smoke Exhaust Series

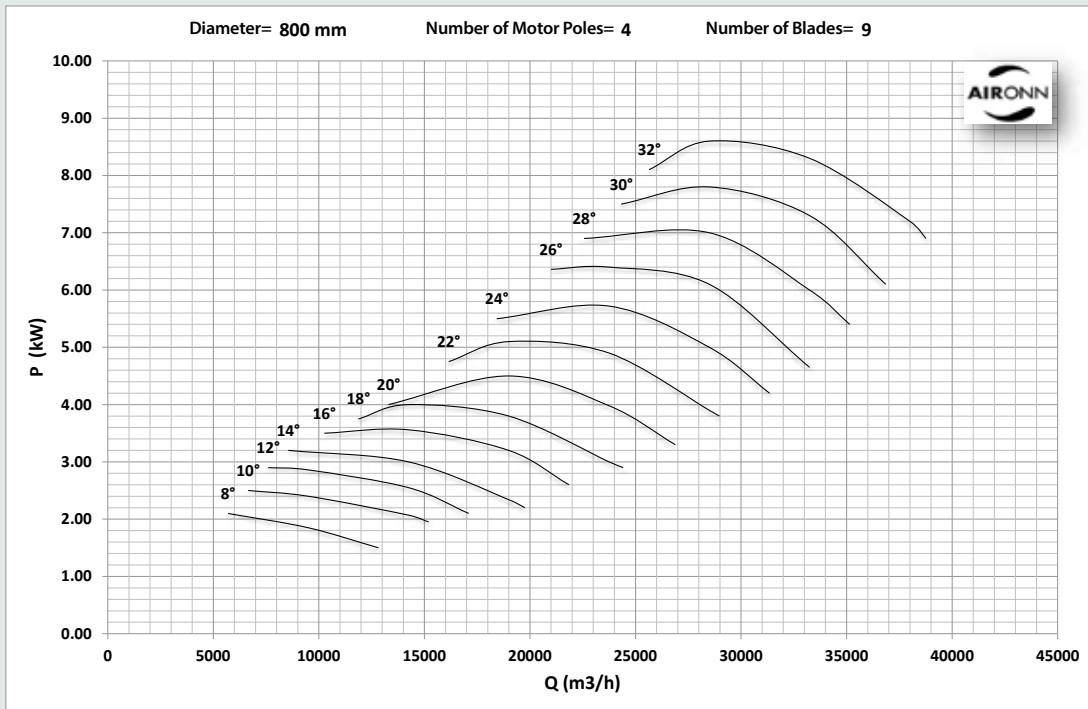
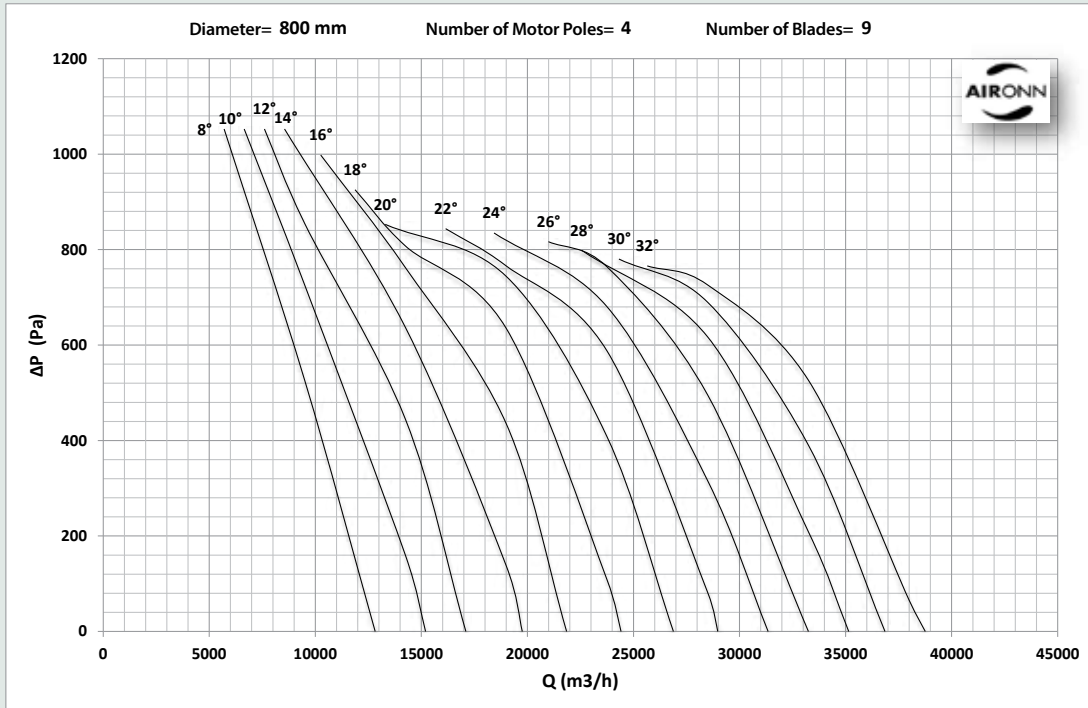

# Twin Spindle Axial Type Smoke Exhaust Series

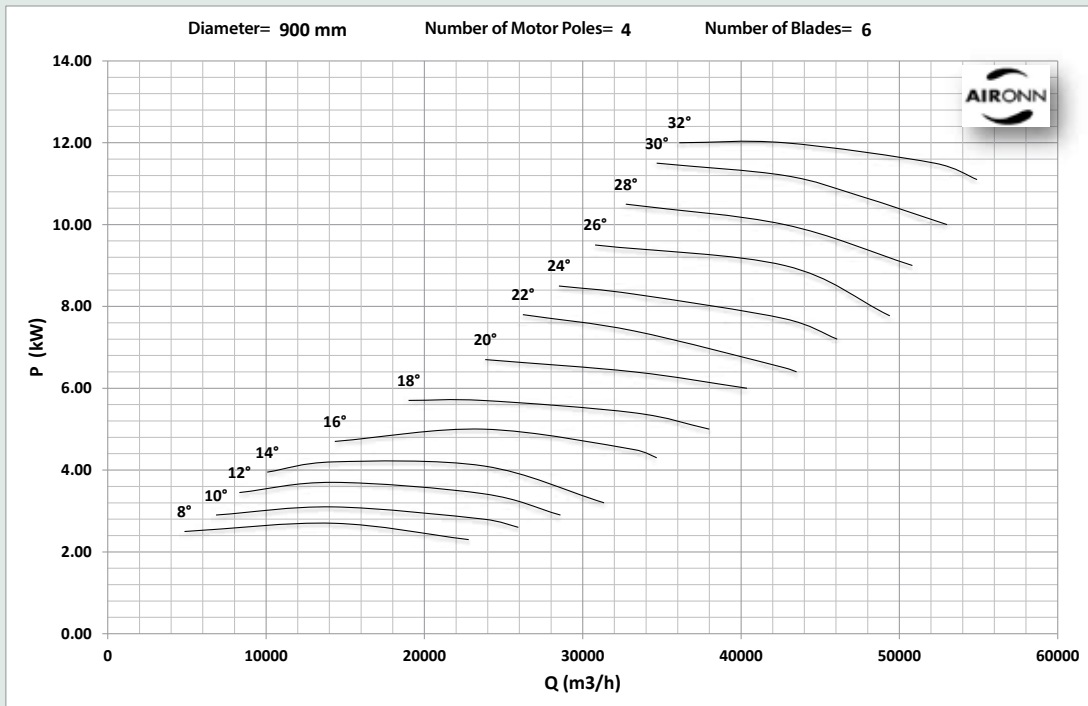
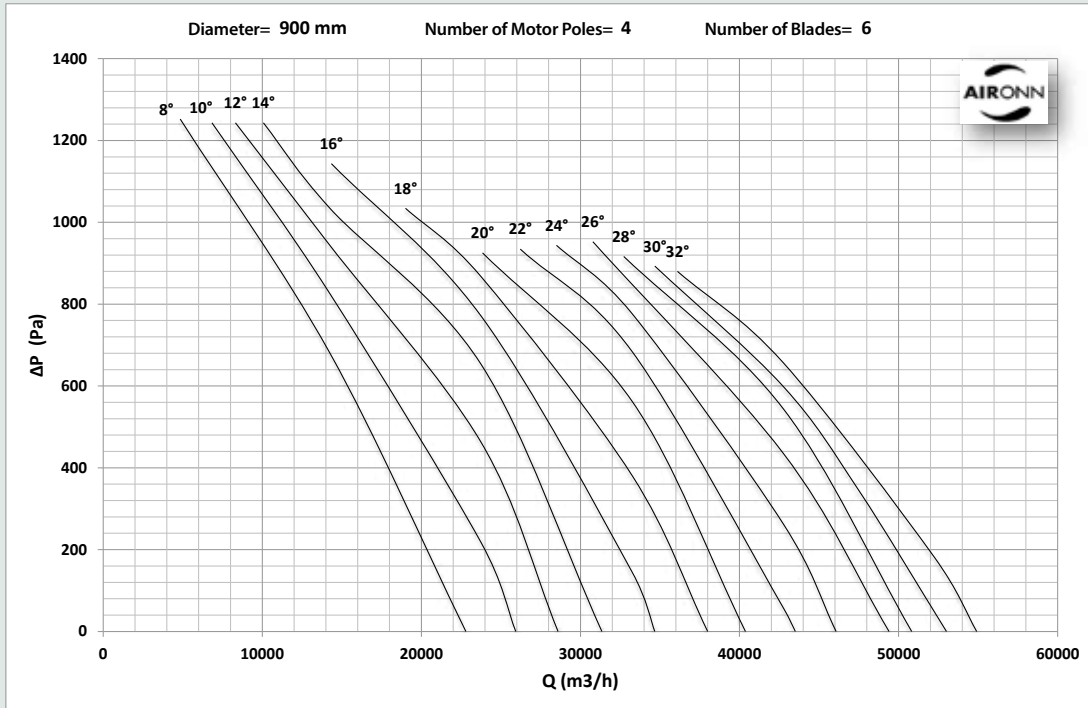

# Twin Spindle Axial Type Smoke Exhaust Series

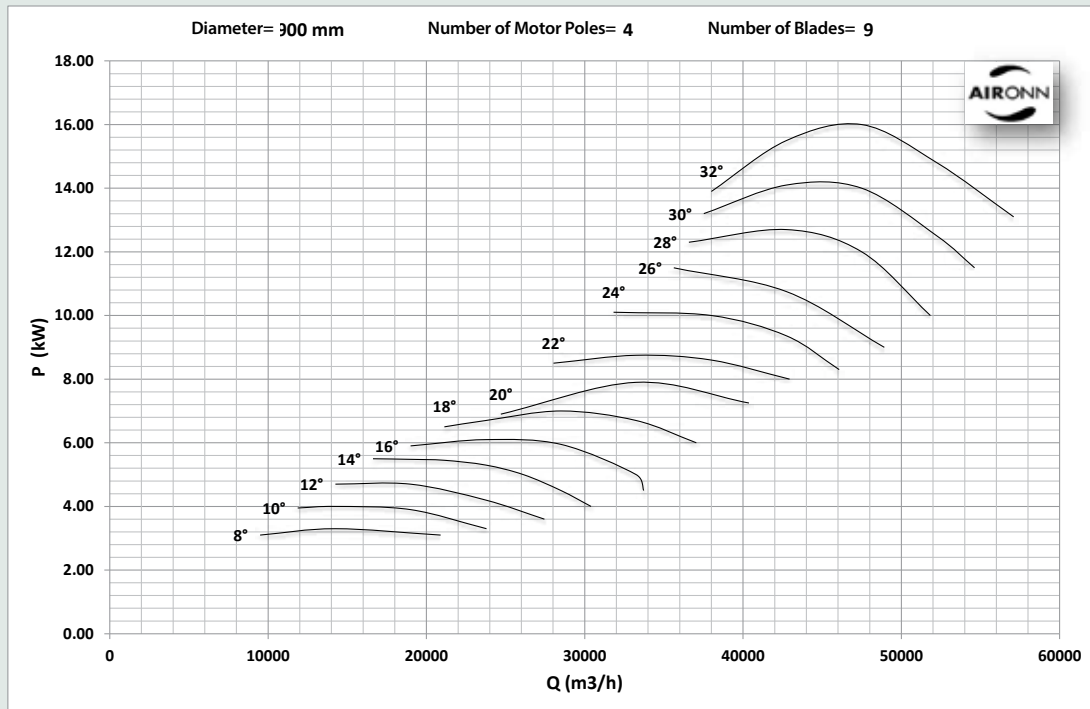
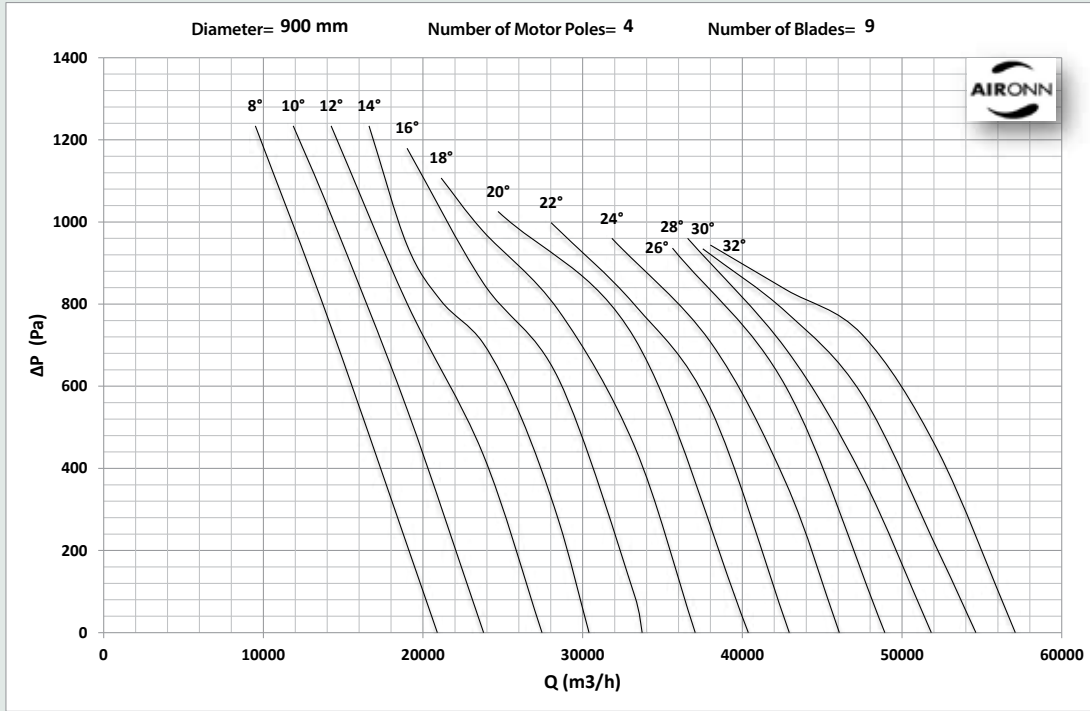

# Twin Spindle Axial Type Smoke Exhaust Series

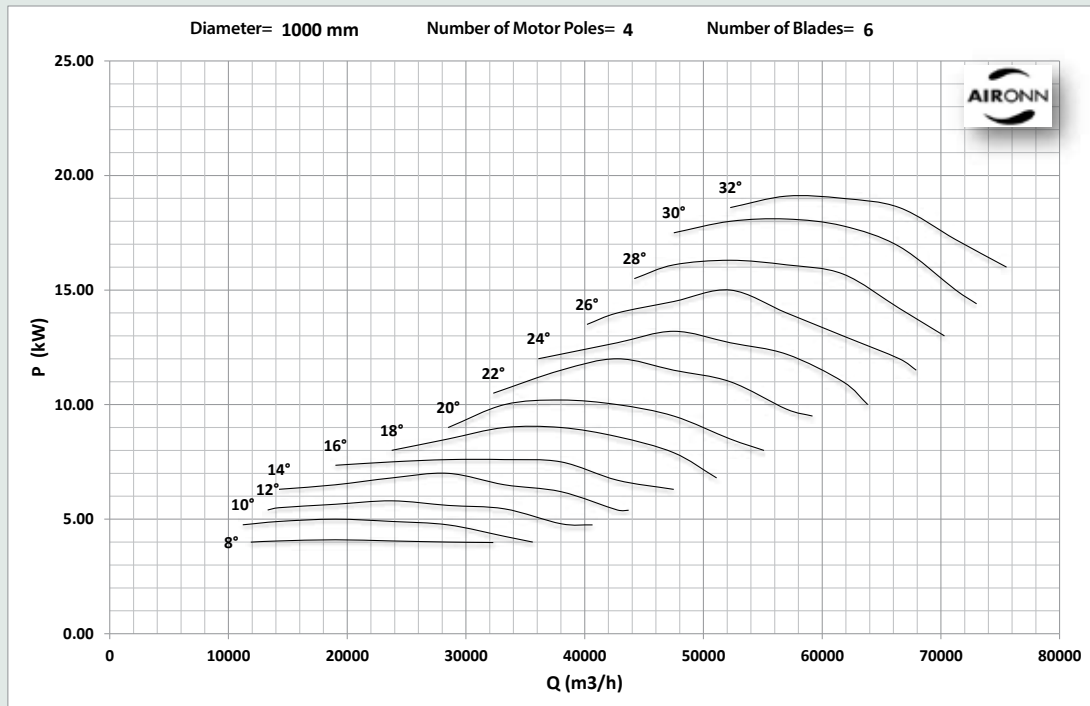
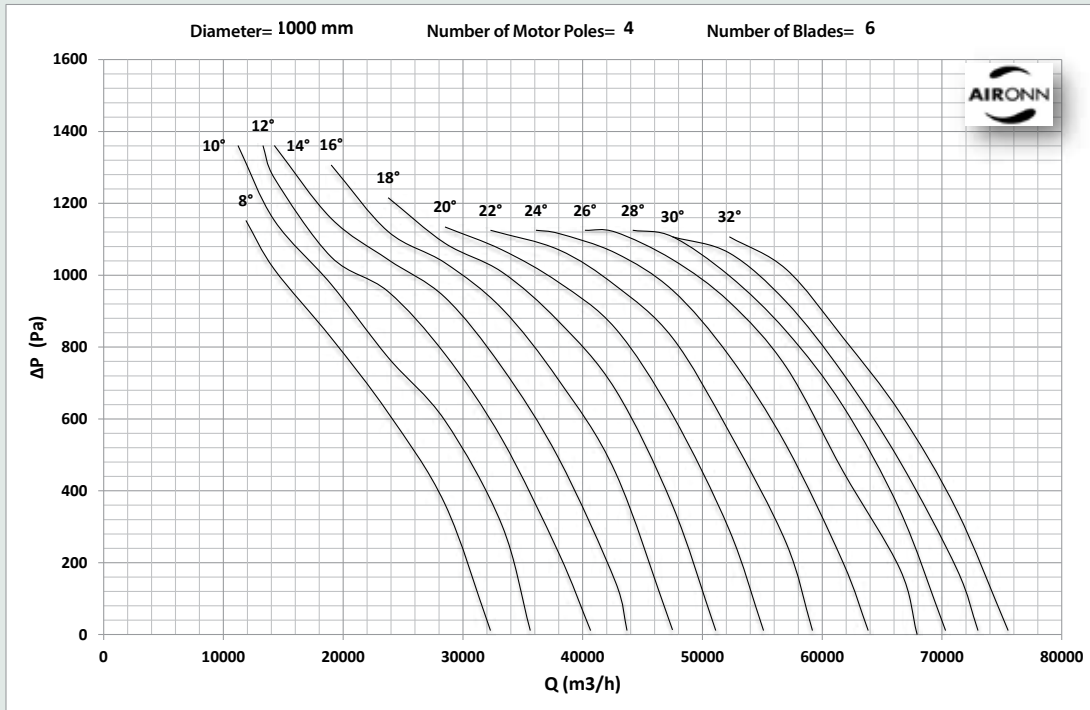



# Twin Spindle Axial Type Smoke Exhaust Series

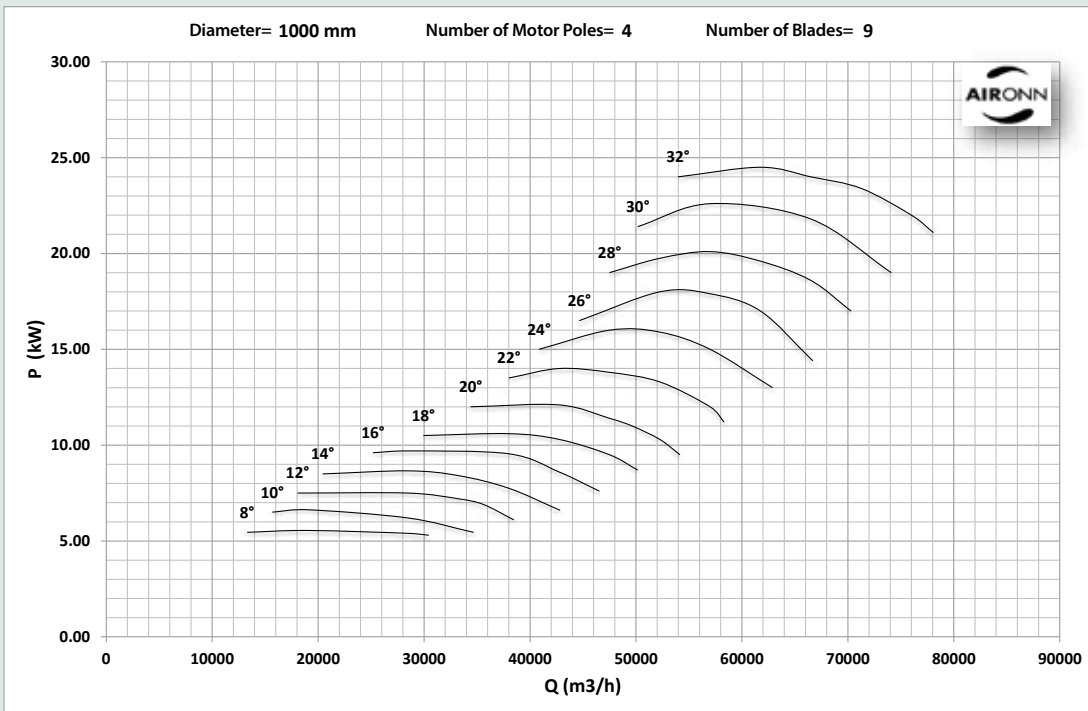
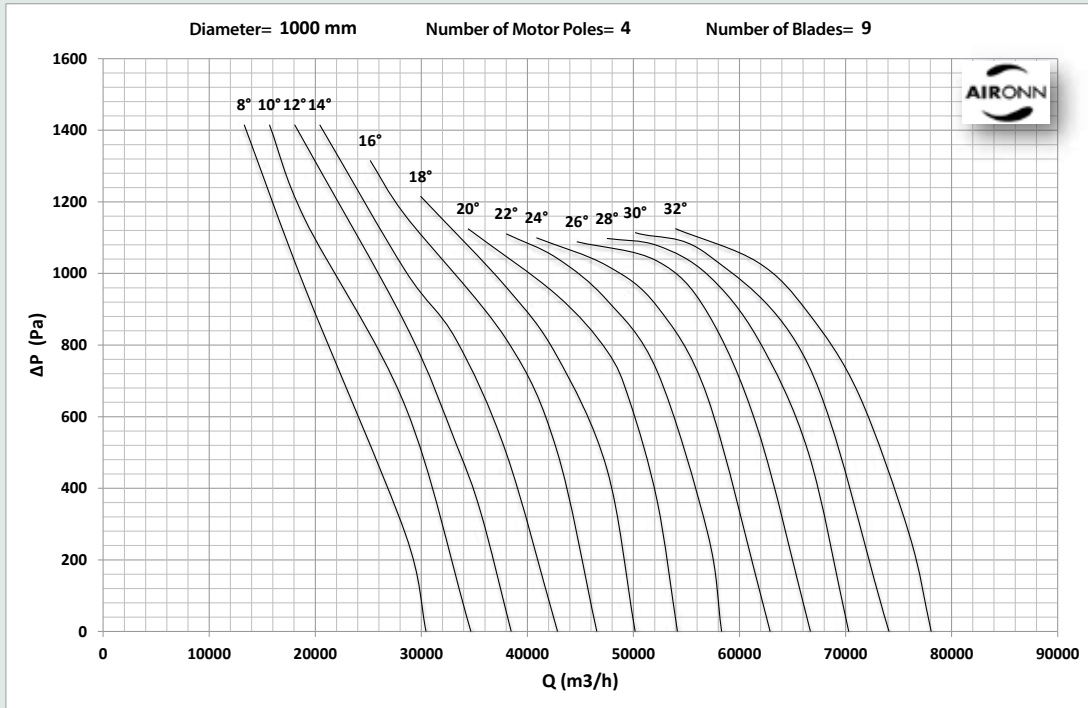

# Twin Spindle Axial Type Smoke Exhaust Series

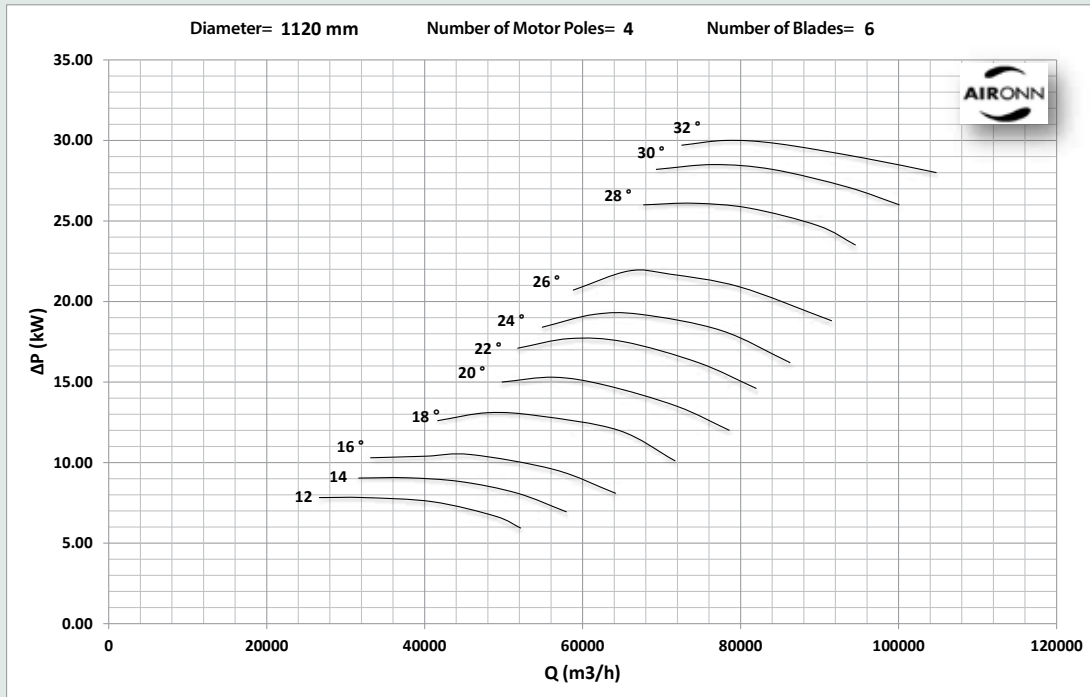
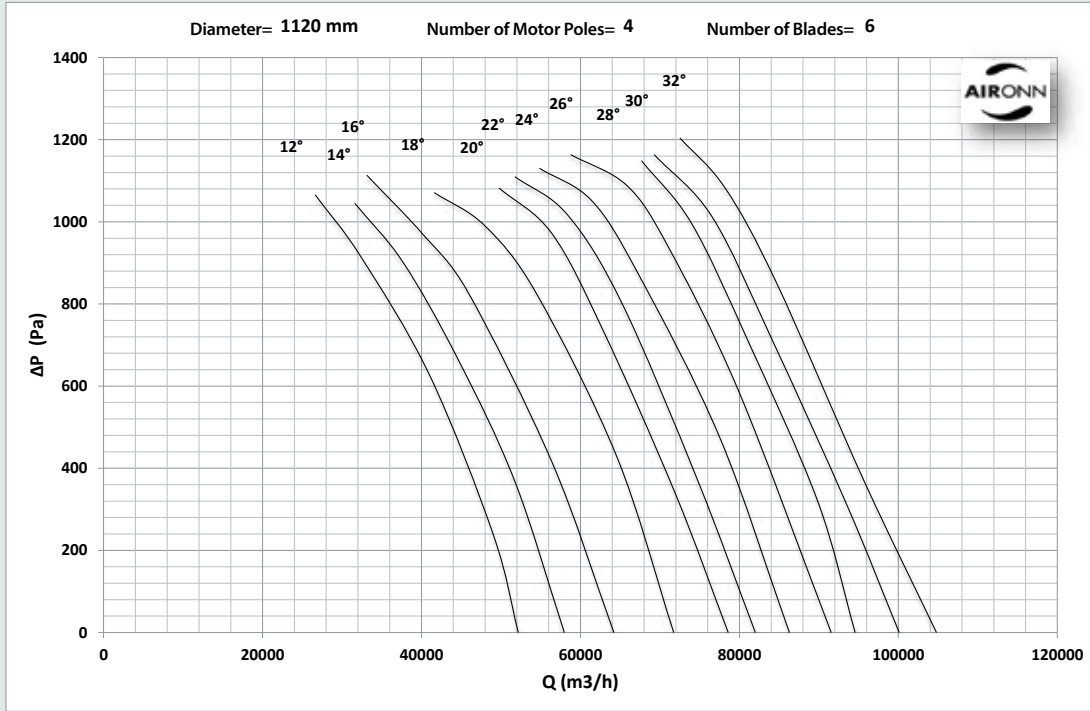

# Twin Spindle Axial Type Smoke Exhaust Series

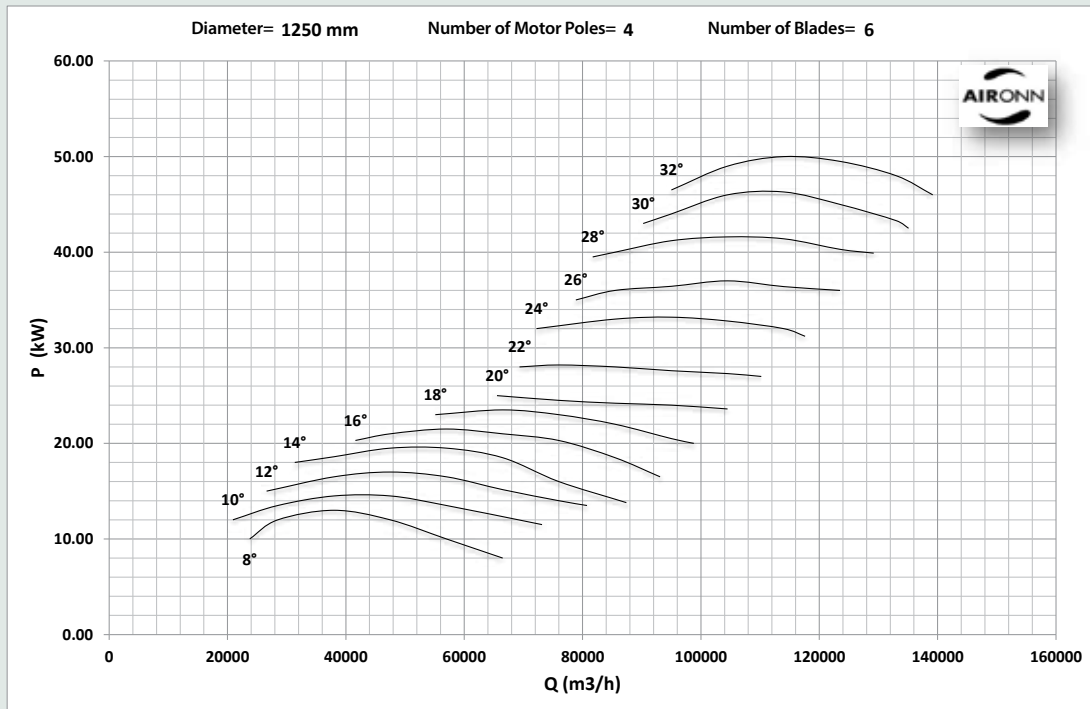
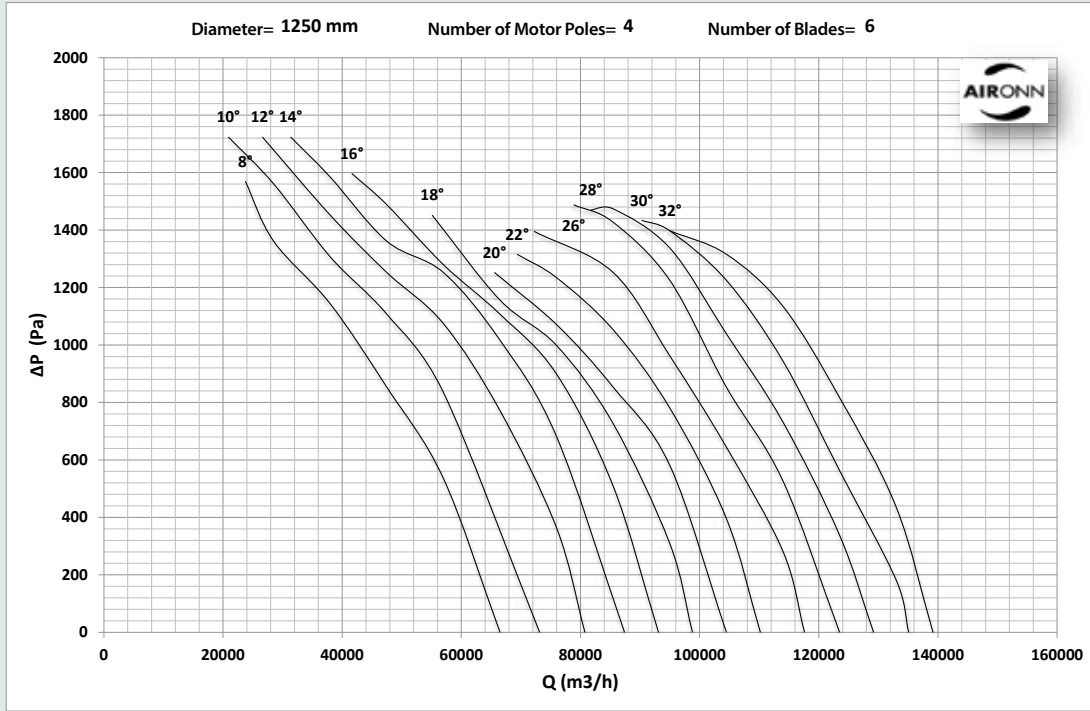

# Twin Spindle Axial Type Smoke Exhaust Series

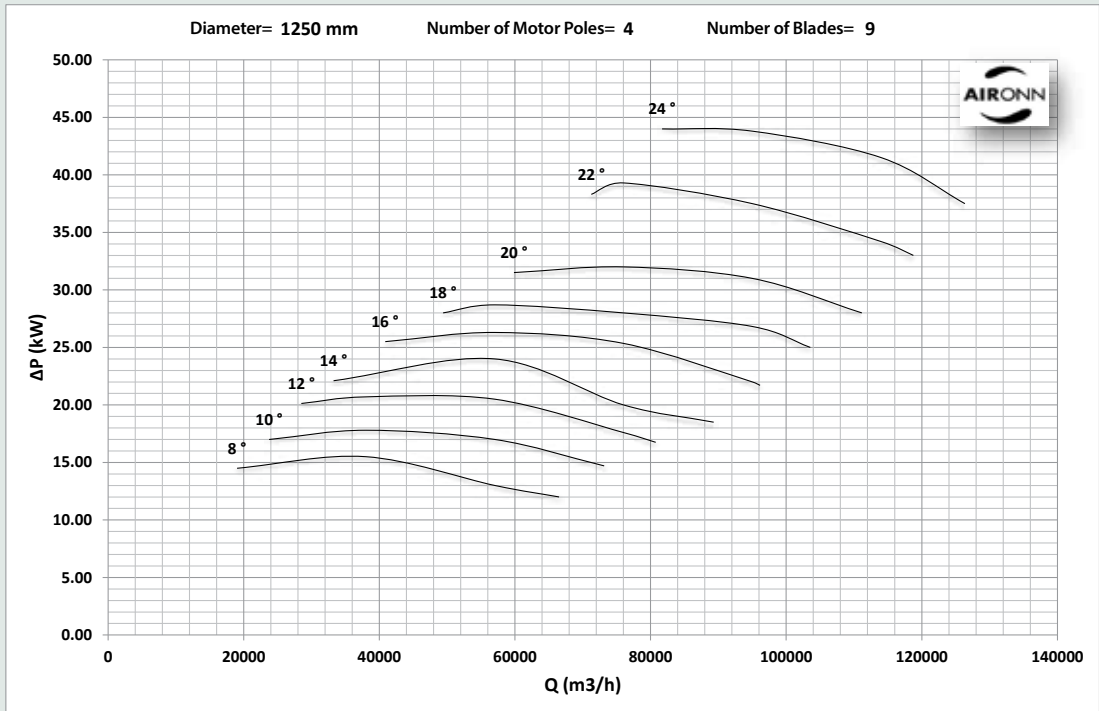
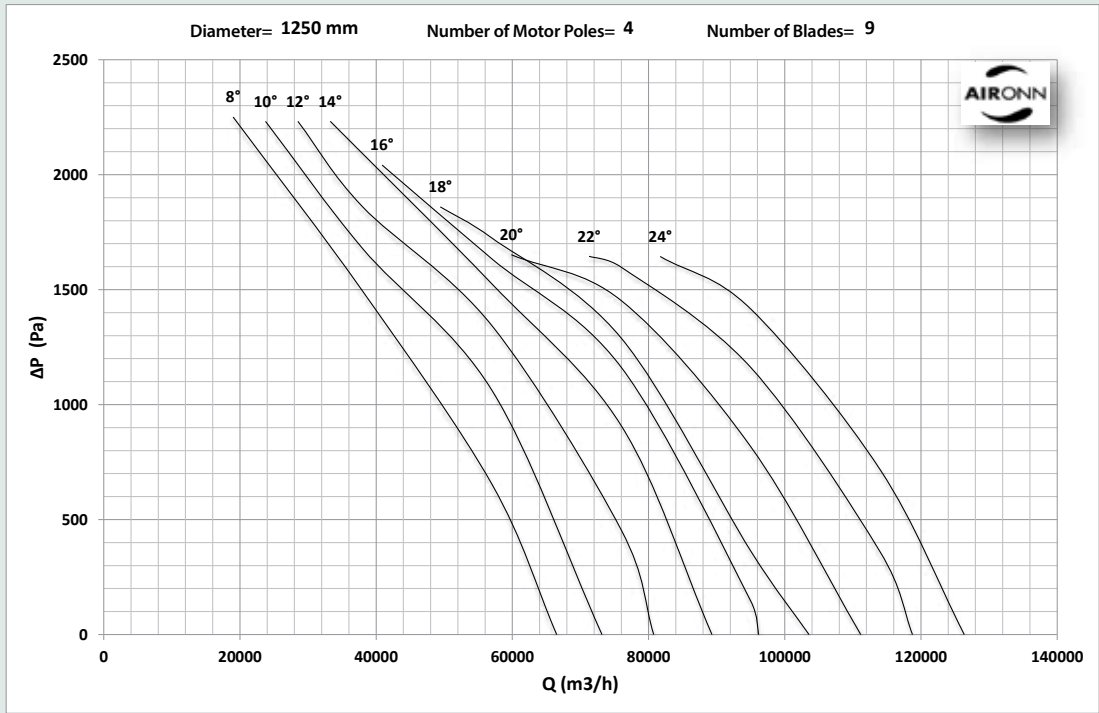



# Lobby Type Axial Smoke Exhaust Fan Series for Roofs

Fans in the Aironn Lobby Type Axial Smoke Exhaust Fan Series for Roofs have 300 °C-2 hours and 400 °C-2 hours certificates in compliance with EN 12101-3. Lobby Type Axial Smoke Exhaust Fan Series for Roofs available in the range of diameters between 400 mm and 1250 mm prevent heat transfer due to their motor-driven folding damper and 50 mm-thick thermal insulation and they are fast acting due to their damper's opening in a short time when they are needed to operate. Automatic folding damper can bear snow load on the door up to 1000 N by means of its powerful motor. The switch on the fan shows that whether the damper is open or closed. The waterproof body is made of stainless galvanized steel and in line with demand, it can be painted with special dye in any color. Due to its 50 mm thermal insulation, heat loss is prevented when weather conditions are different in internal and external environments.

Performance of the fans in Aironn Lobby Type Axial Smoke Exhaust Fan Series for Roofs have been tested in accordance with AMCA 210-07 standard.

## Fan Body

The body of the fans is made of high quality and corrosion resistant hot-dip galvanized coated sheet metal. The fan flanges are manufactured by bending the body so they are self flanged. Standard production is long-bodied. Body inspection hatch is optional.

## Fan Blades

Aerodynamic fan blades are made of ETIAL 171 with injection moulding method. They are statically and dynamically balanced in compliance with ISO 1940/1-2003.

## Motor

They have 2 IP 55 motors with class H insulation available in single cycle or double cycle options. If requested, single cycle motors can be used with inverters.

## Electricity

IP 55 electric terminal box made of aluminium is standard.

## Accessories

Counter Flange, Protection Grill, Back Draft Damper, Flexible Coupling, Pacco (Package) Switch, Vibration Sensor, Inverter



# Lobby Type Axial Fresh Air Fan Series for Roofs

Fans in Aironn Twin Spindle Axial Type Fresh Air Fan Series are suitable to operate at maximum 55 °C. Lobby Type Axial Smoke Exhaust Fan Series for Roofs available in the range of diameters between 400 mm and 1250 mm prevent heat transfer due to their motor-driven folding damper and 50 mm-thick thermal insulation and they are fast acting due to their damper's opening in a short time when they are needed to operate. Automatic folding damper can bear snow load on the door up to 1000 N by means of its powerful motor. The switch on the fan shows that whether the damper is open or closed. The waterproof body is made of stainless galvanized steel and in line with demand, it can be painted with special dye in any color. Due to its 50 mm thermal insulation, heat loss is prevented when weather conditions are different in internal and external environments.

Performance of the fans in Aironn Lobby Type Axial Smoke Exhaust Fan Series for Roofs have been tested in accordance with AMCA 210-07 standard.

## Fan Body

The body of the fans is made of high quality and corrosion resistant hot-dip galvanize coated sheet metal. The fan flanges are manufactured by bending the body so they are self flanged. Standard production is long-bodied. Body inspection hatch is optional.

## Fan Blades

Aerodynamic fan blades are made of ETIAL 171 with injection moulding method. They are statically and dynamically balanced in compliance with ISO 1940/1-2003.

## Motor

They have 2 IP 55 motors with class F insulation available in single cycle or double cycle options. If requested, single cycle motors can be used with inverters.

## Electricity

IP 55 electric terminal box made of plastic is standard.

## Accessories

Counter Flange, Back Draft Damper, Protection Grill, Flexible Coupling, Pacco (Package) Switch, Vibration Sensor, Inverter



# Lobby Type Axial Smoke Exhaust & Fresh Air Fan Series for Roofs

## Dimensions

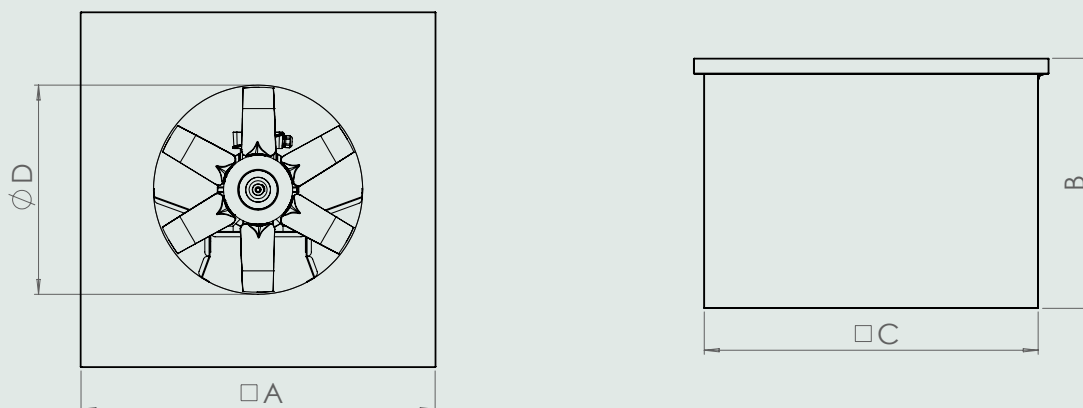

	A	B	C	D
400	1050	1300	950	400
450	1050	1300	950	450
500	1050	1300	950	500
560	1050	1300	950	560
630	1250	1300	1150	630
710	1250	1300	1150	710
800	1250	1300	1150	800
900	1450	1300	1350	900
1000	1450	1300	1350	1000
1250	1450	1300	1350	1250



# Lobby Type Axial Fresh Air Fan Series for Roofs

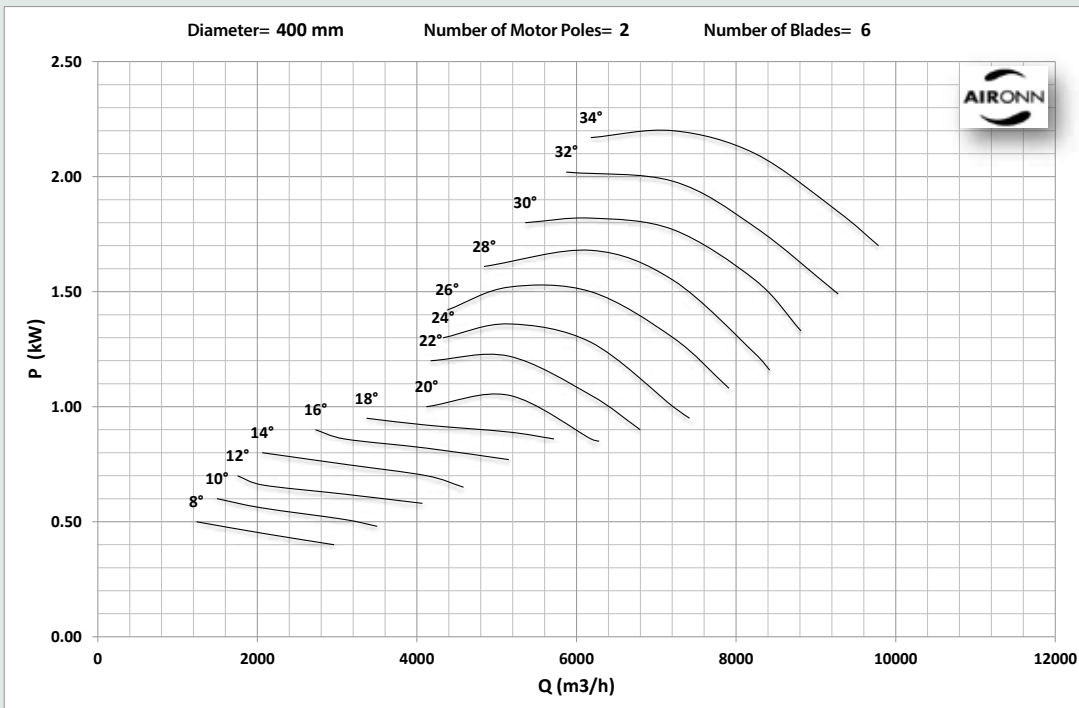
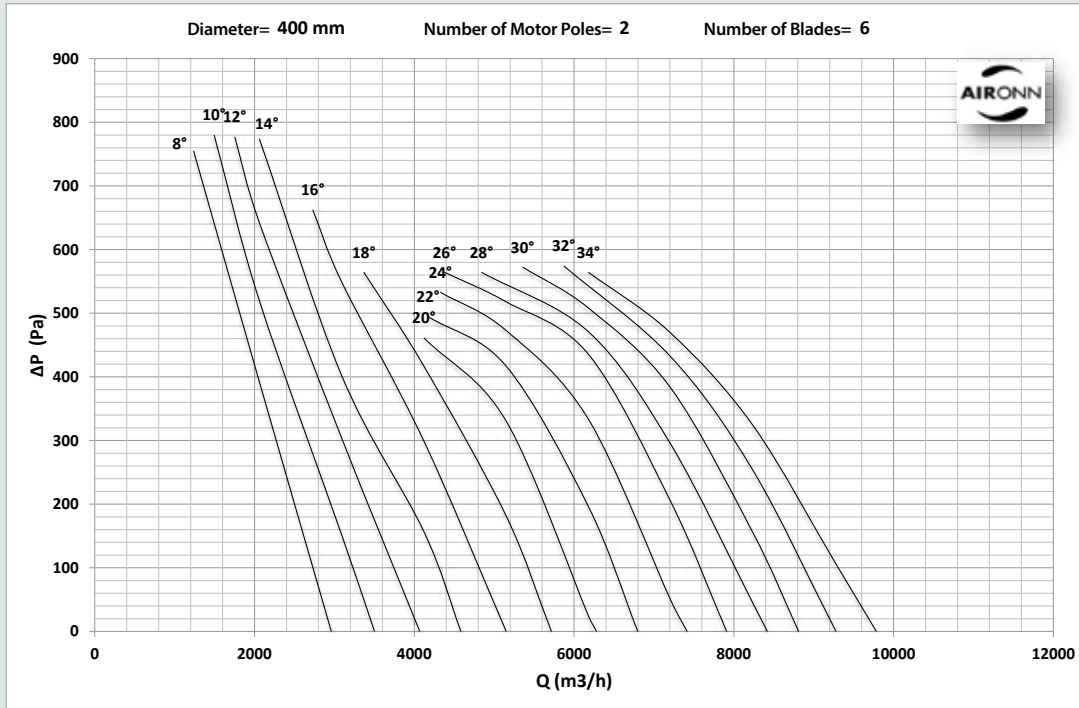

# Lobby Type Axial Fresh Air Fan Series for Roofs

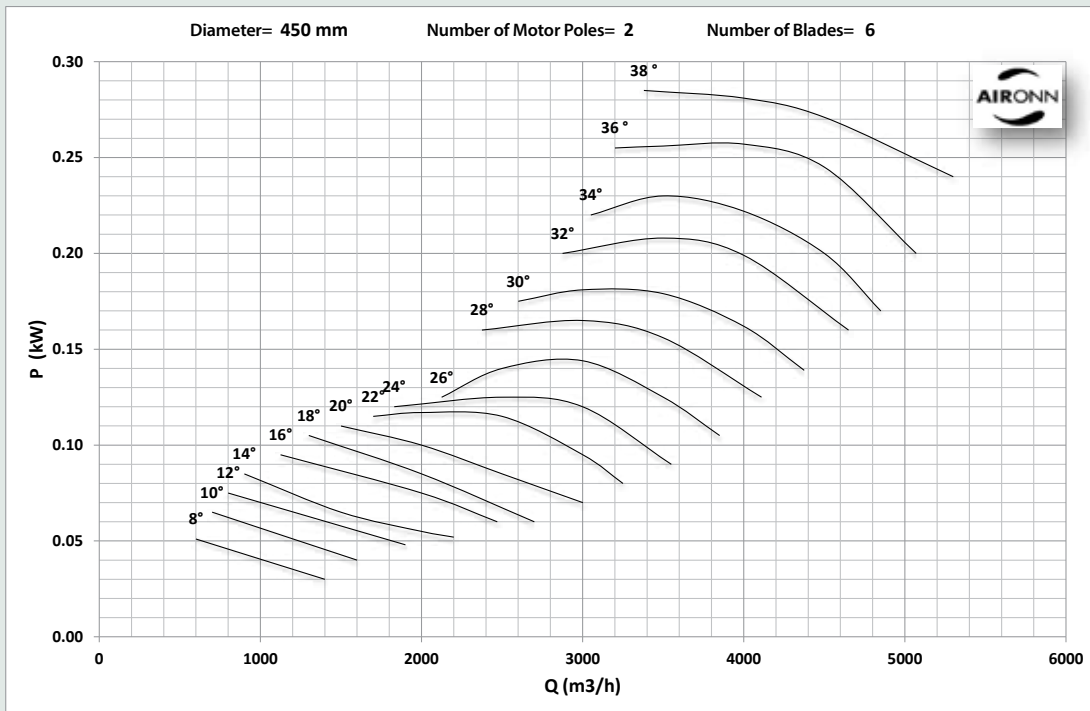
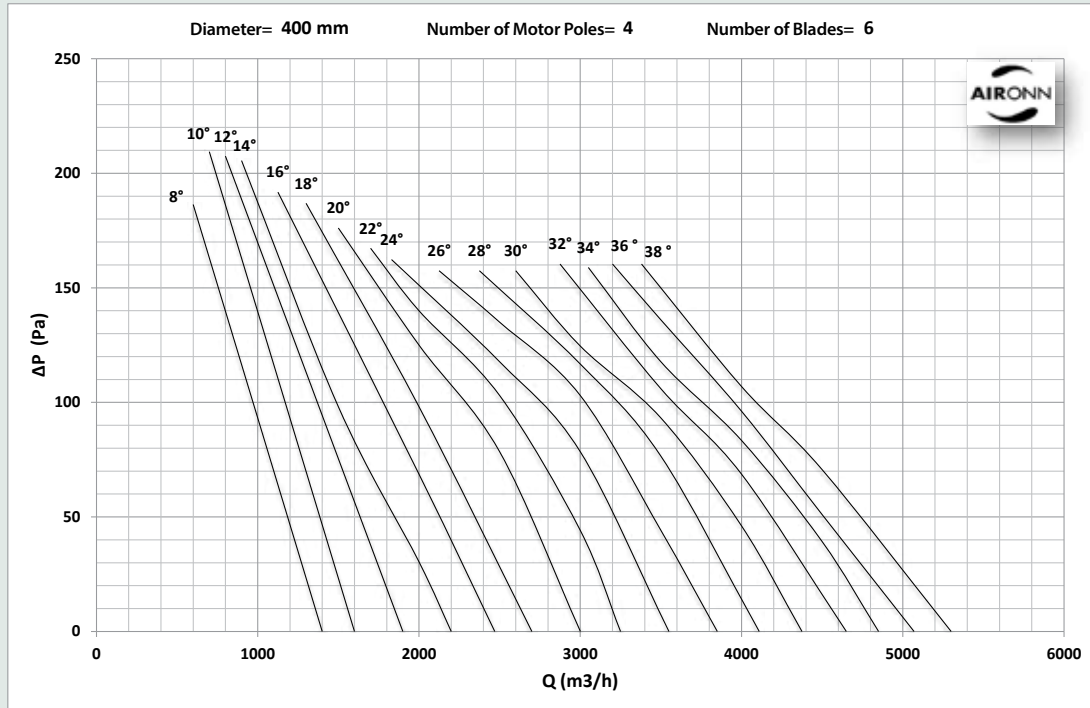

# Lobby Type Axial Fresh Air Fan Series for Roofs

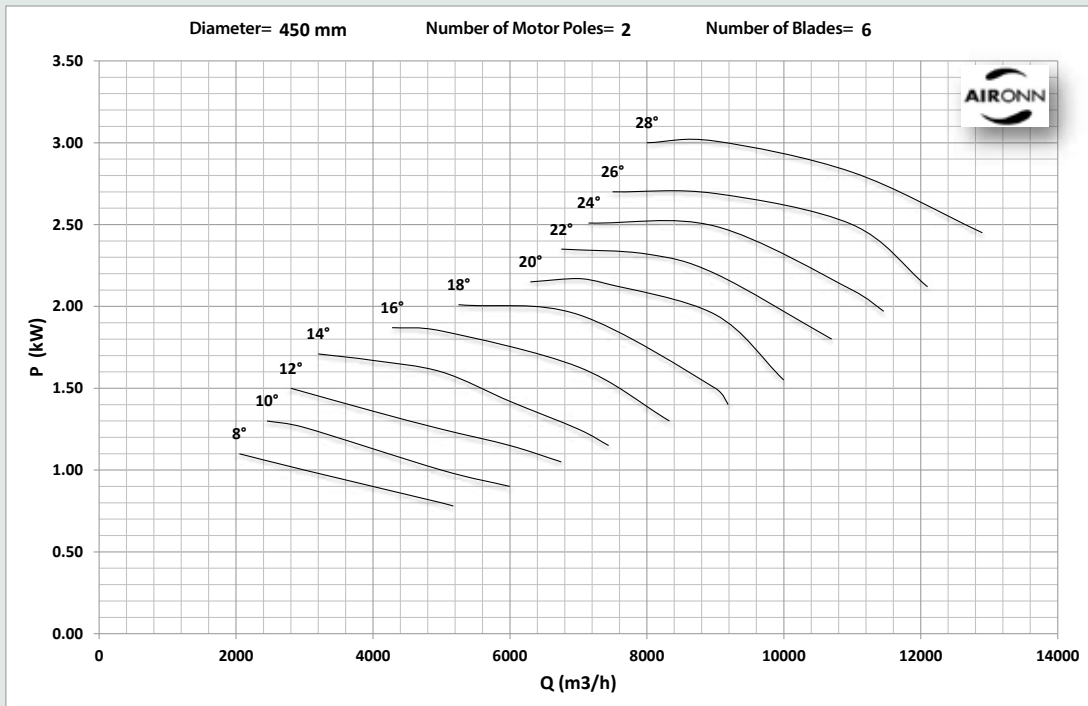
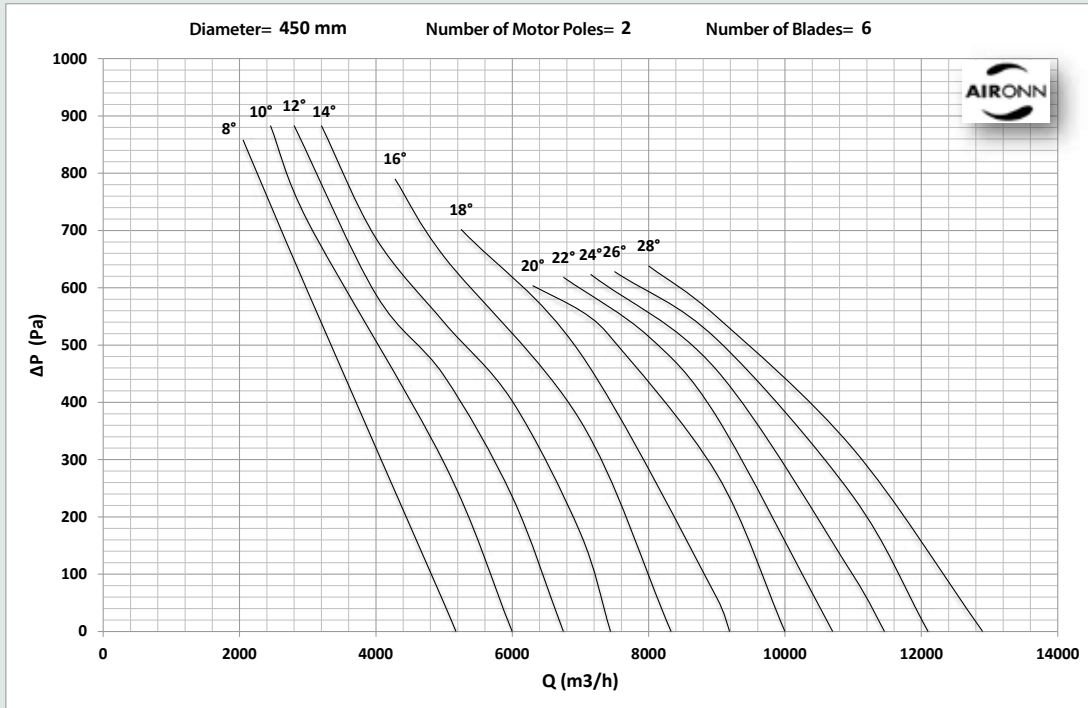

# Lobby Type Axial Fresh Air Fan Series for Roofs

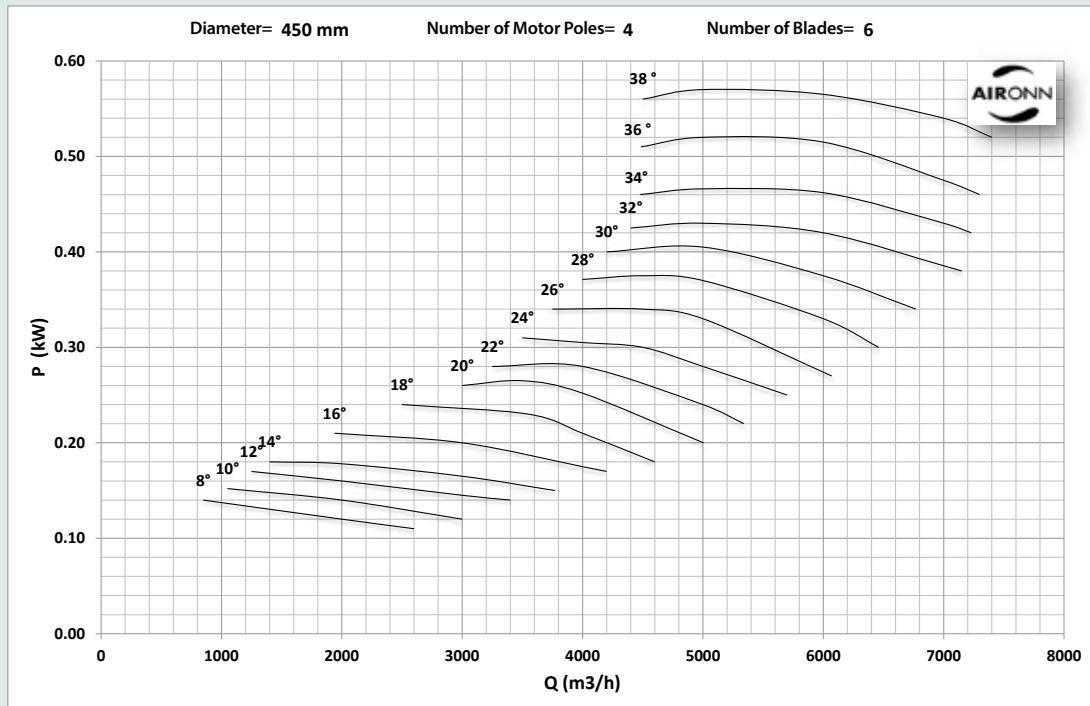
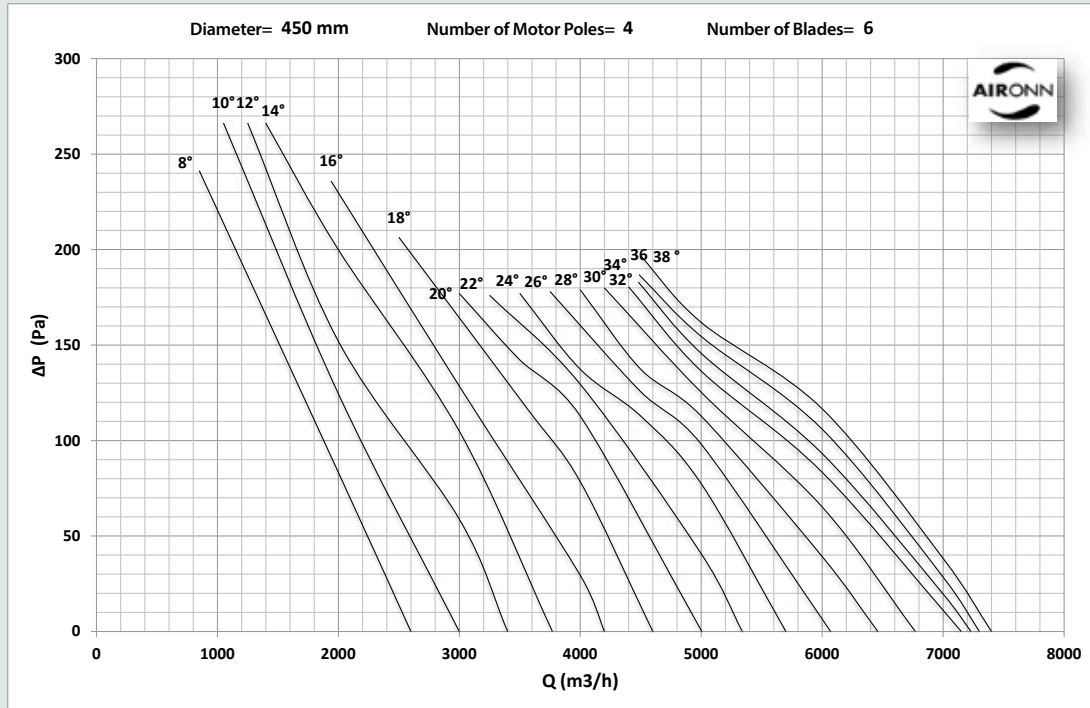

# Lobby Type Axial Fresh Air Fan Series for Roofs

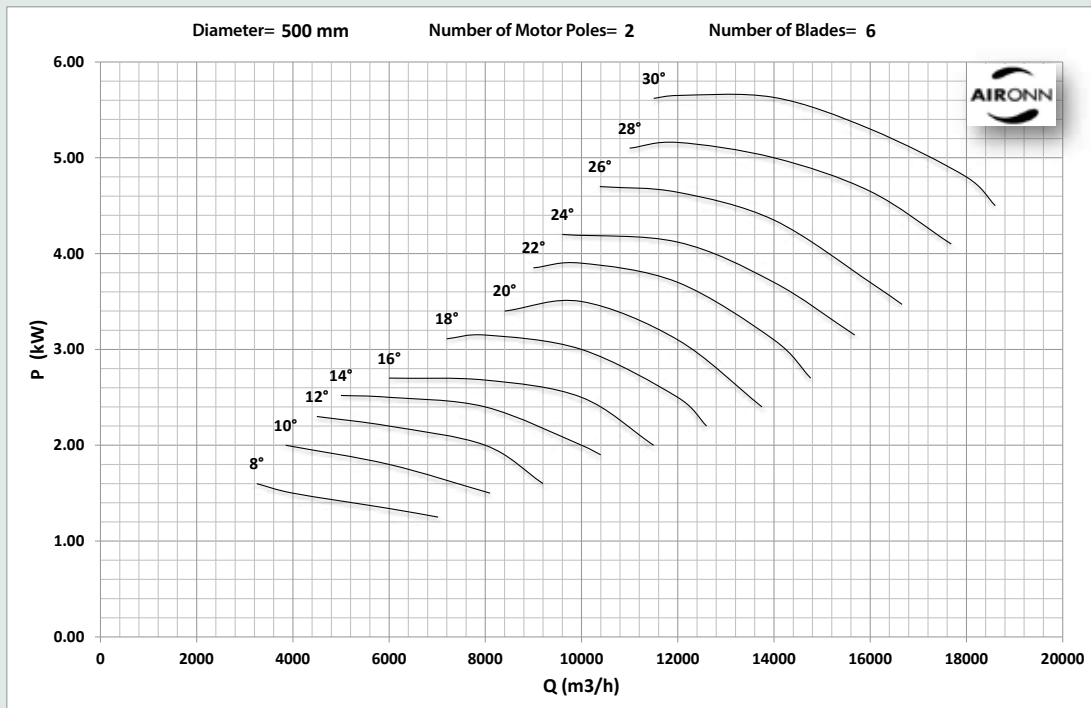
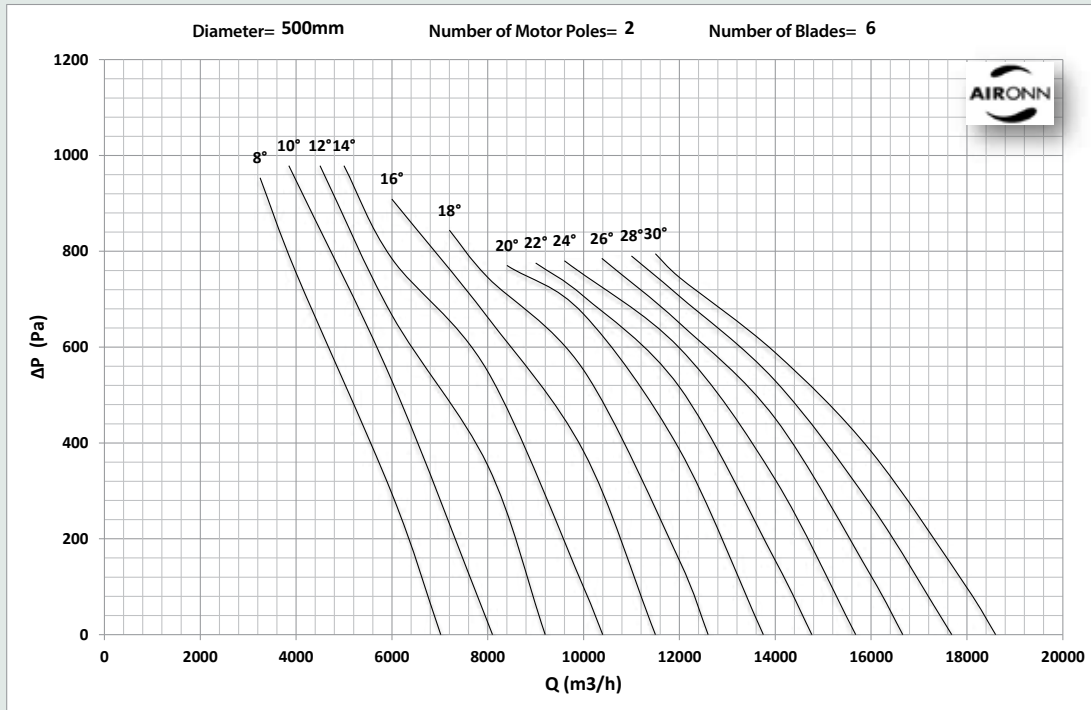

# Lobby Type Axial Fresh Air Fan Series for Roofs

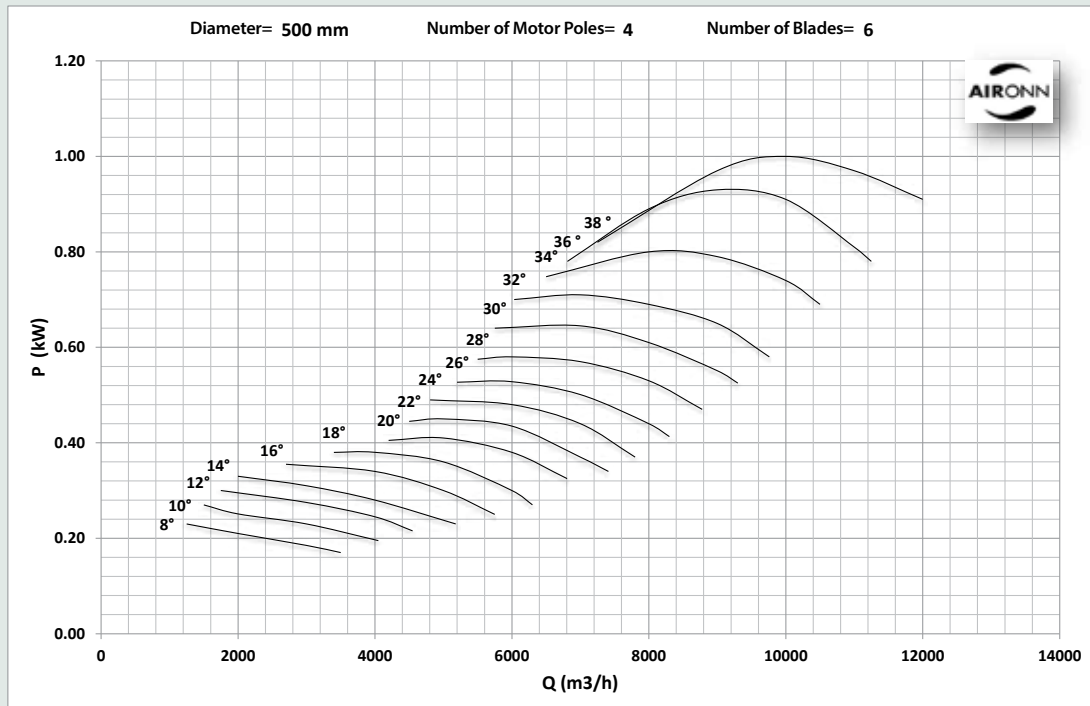
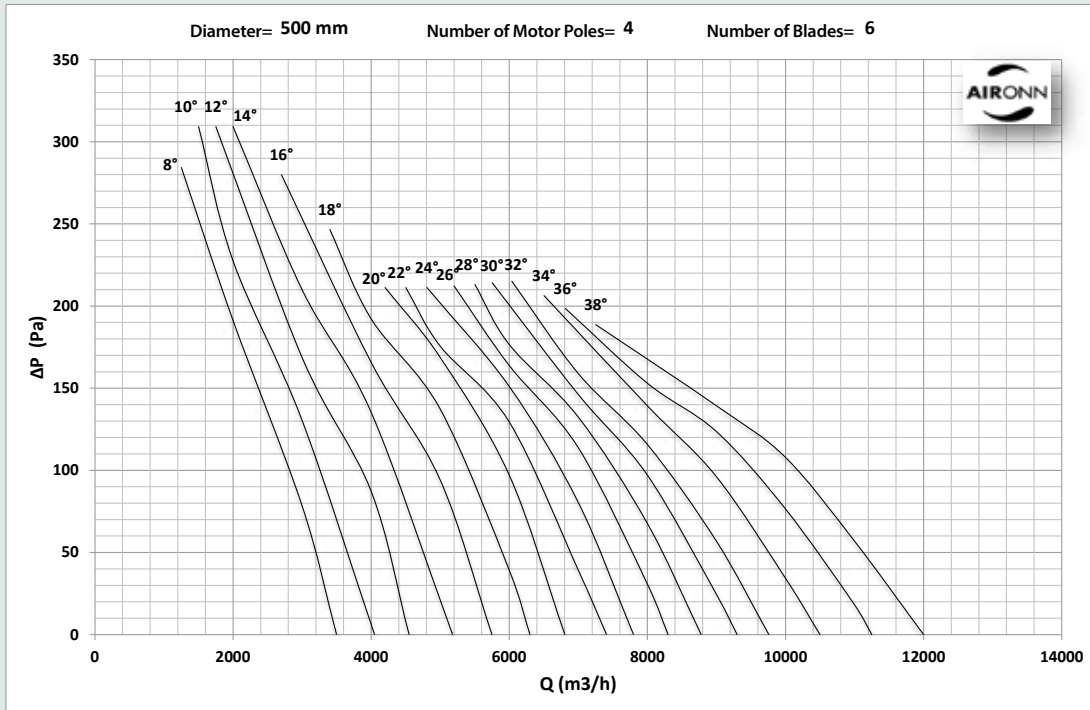

# Lobby Type Axial Fresh Air Fan Series for Roofs

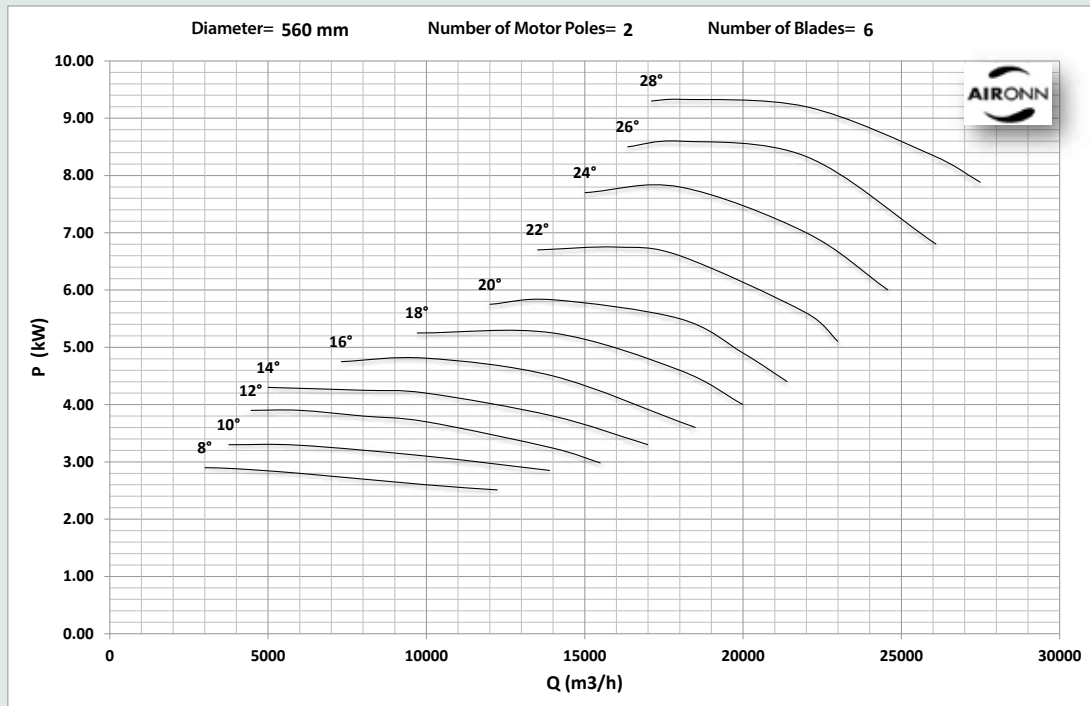
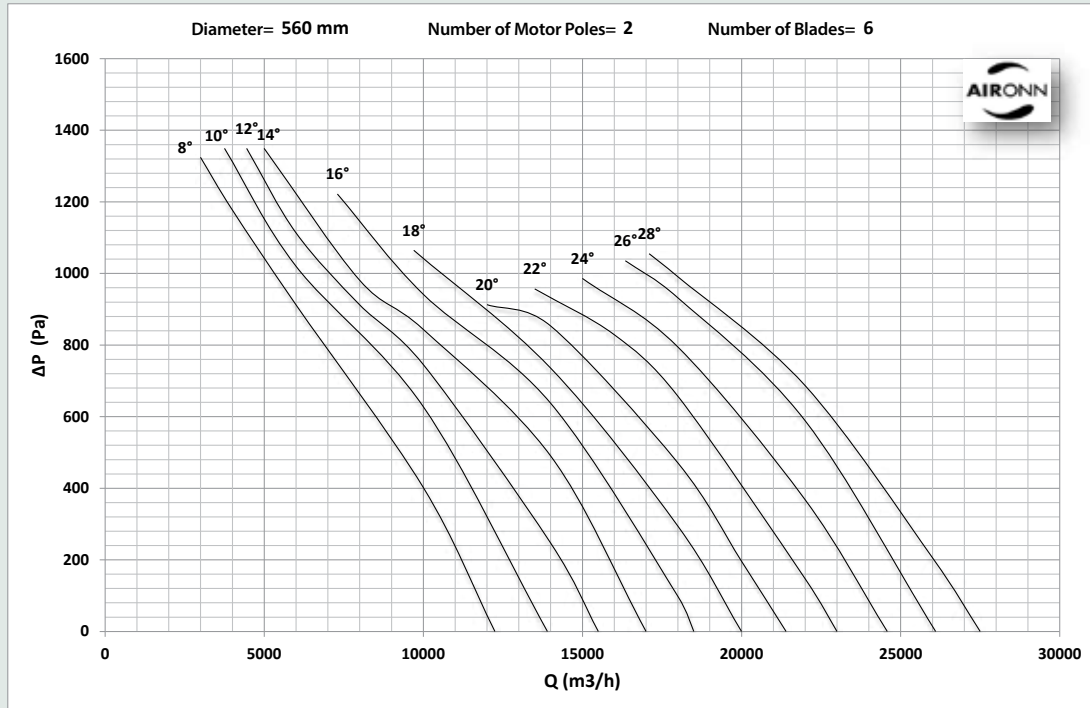

# Lobby Type Axial Fresh Air Fan Series for Roofs

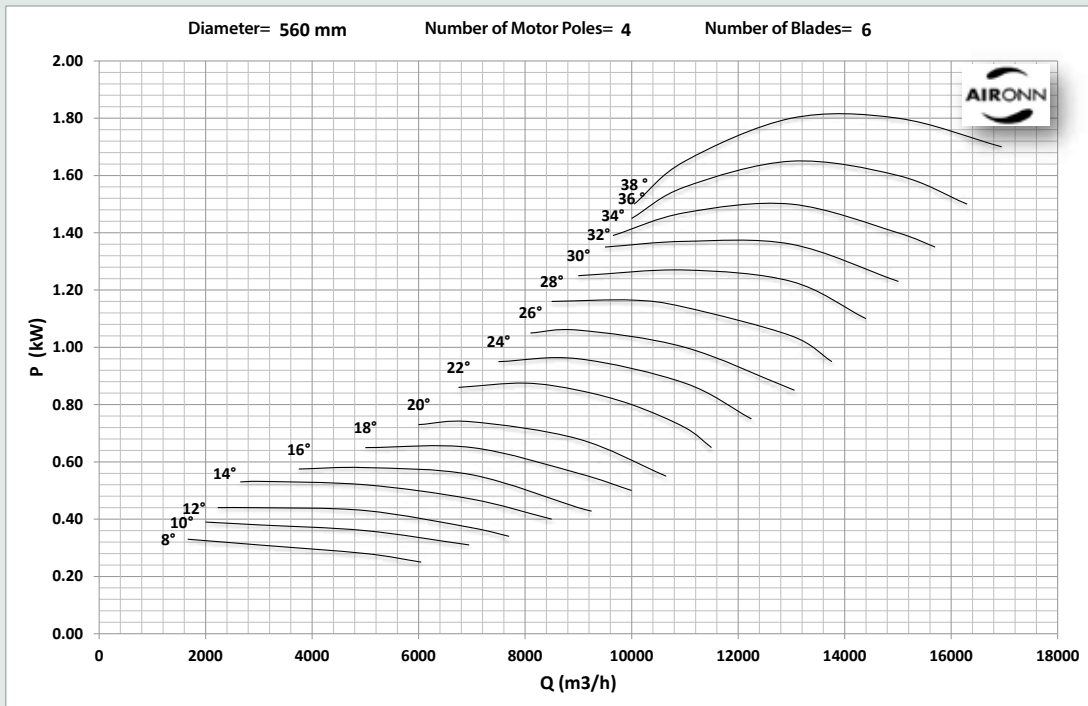
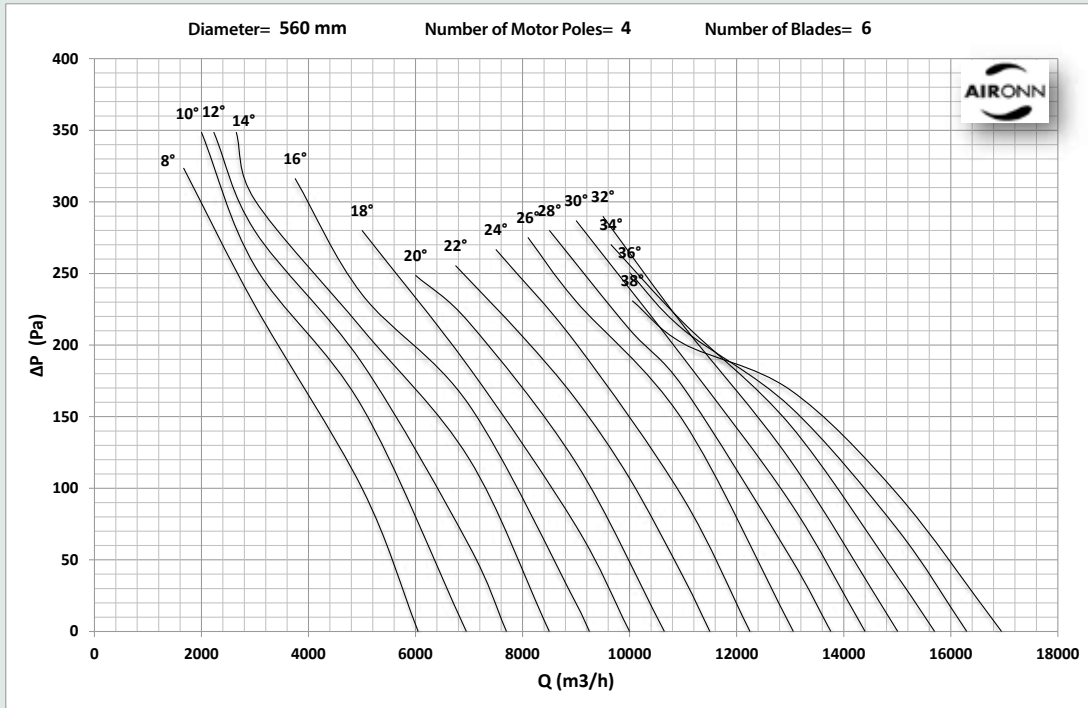



# Lobby Type Axial Fresh Air Fan Series for Roofs

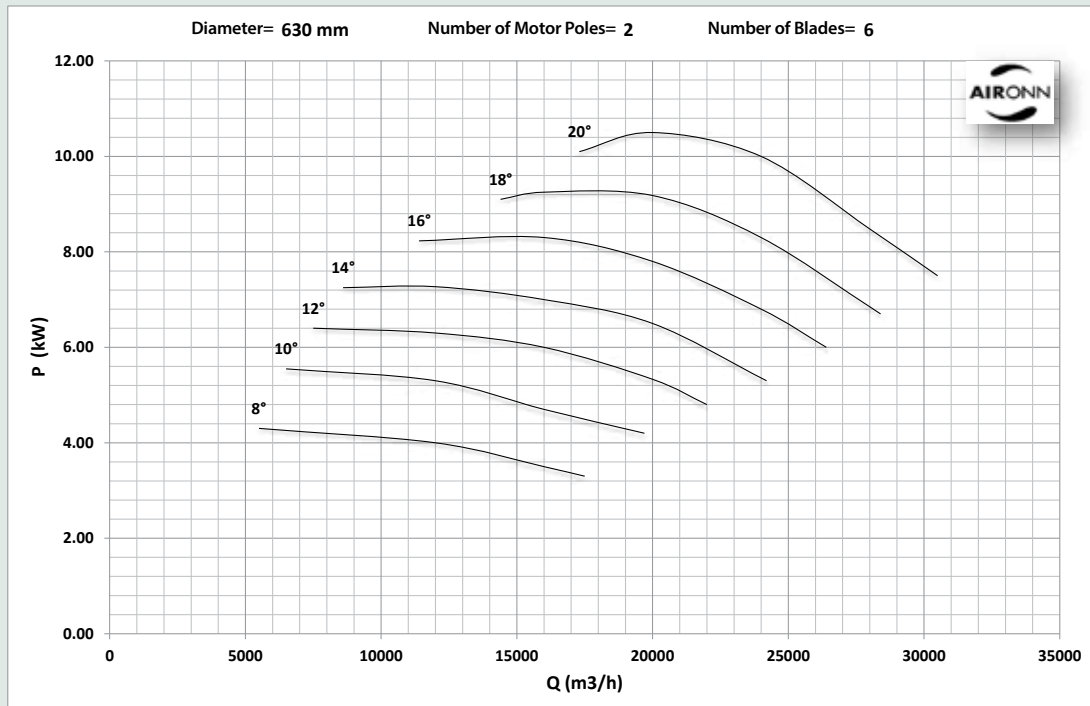
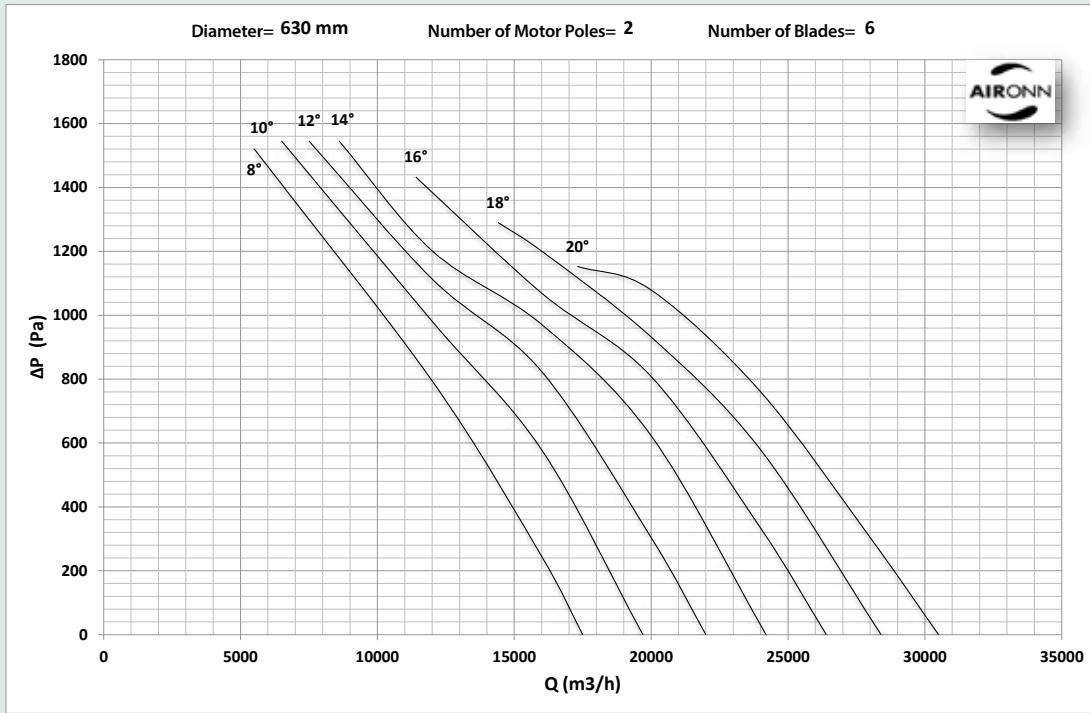

# Lobby Type Axial Fresh Air Fan Series for Roofs

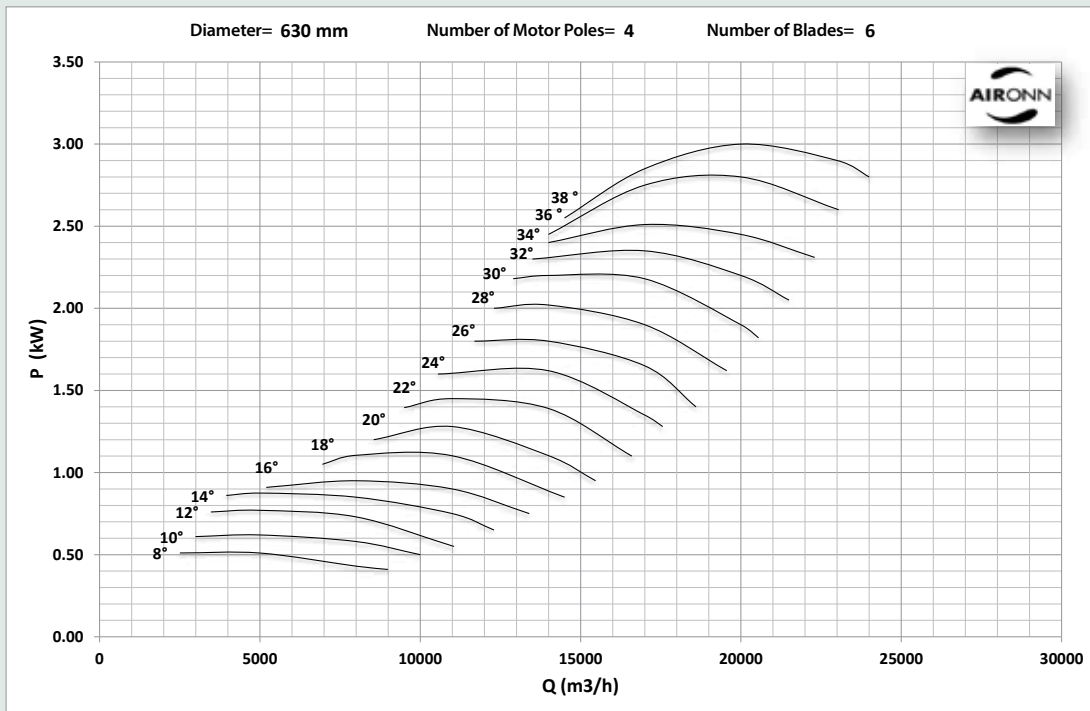
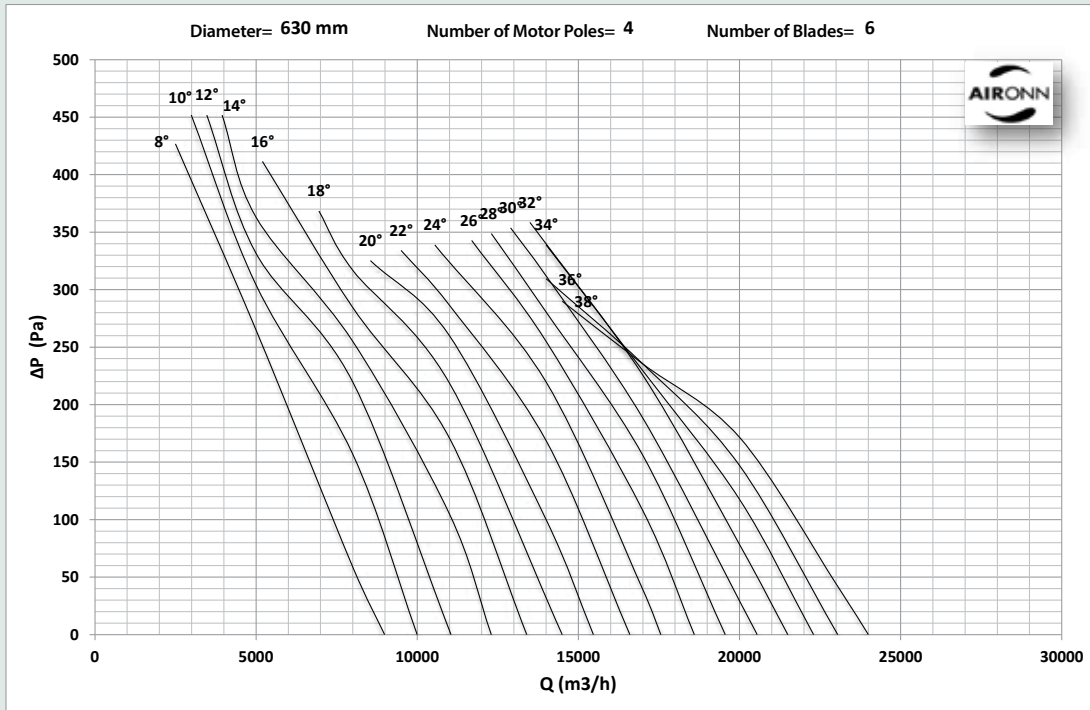

# Lobby Type Axial Fresh Air Fan Series for Roofs

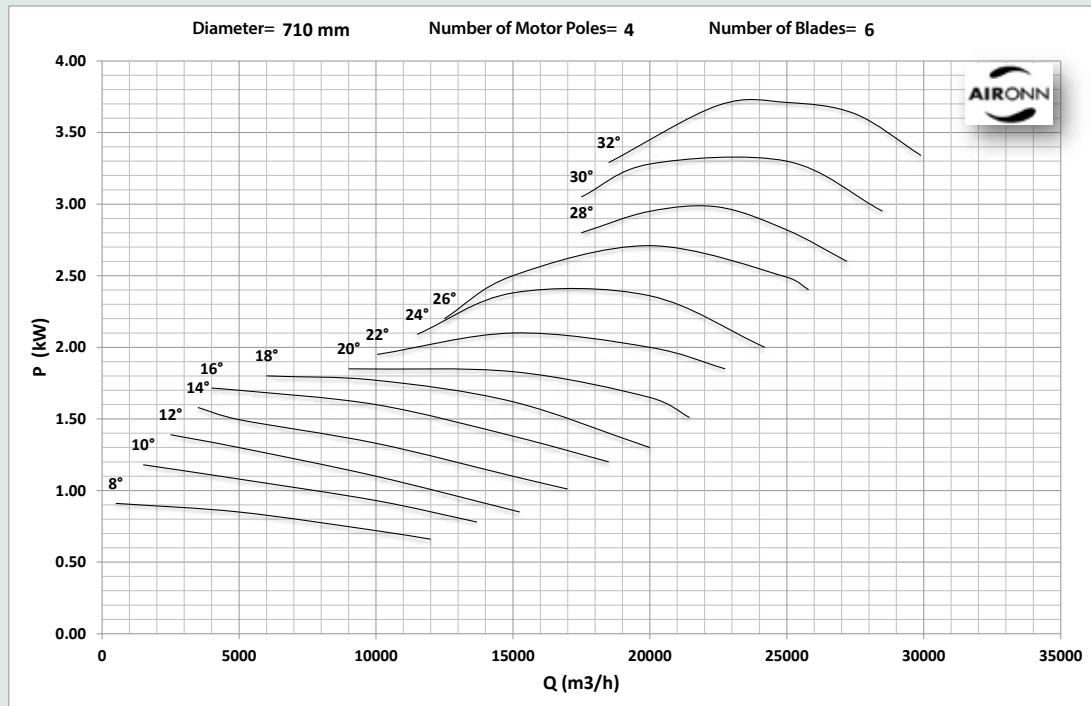
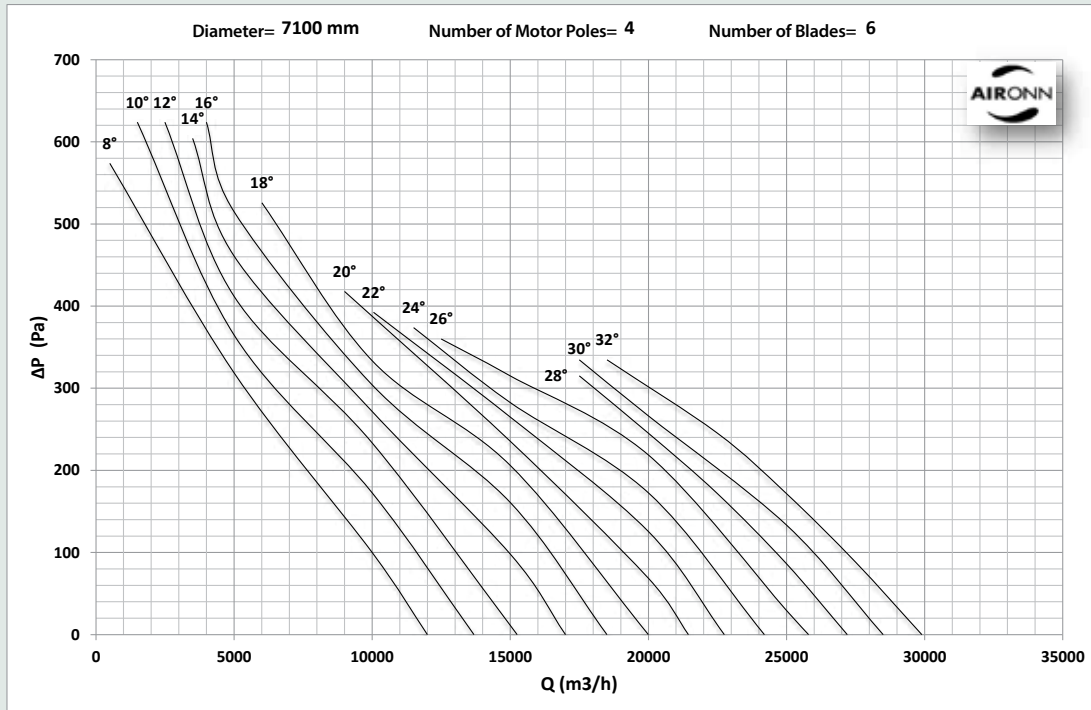

# Lobby Type Axial Fresh Air Fan Series for Roofs

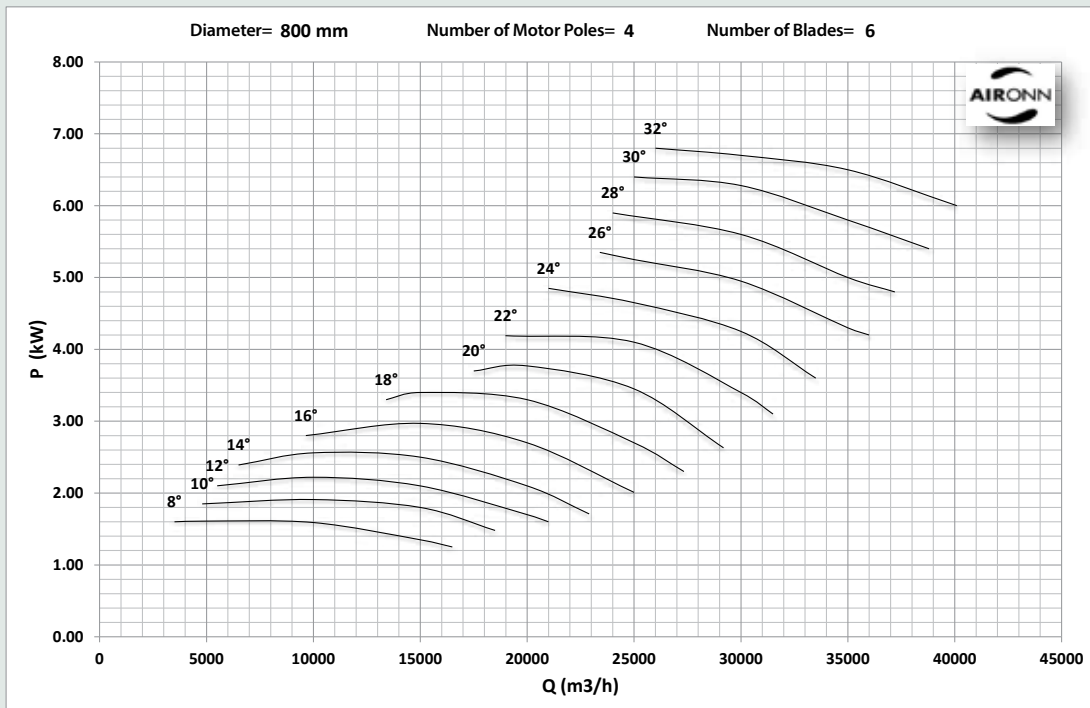
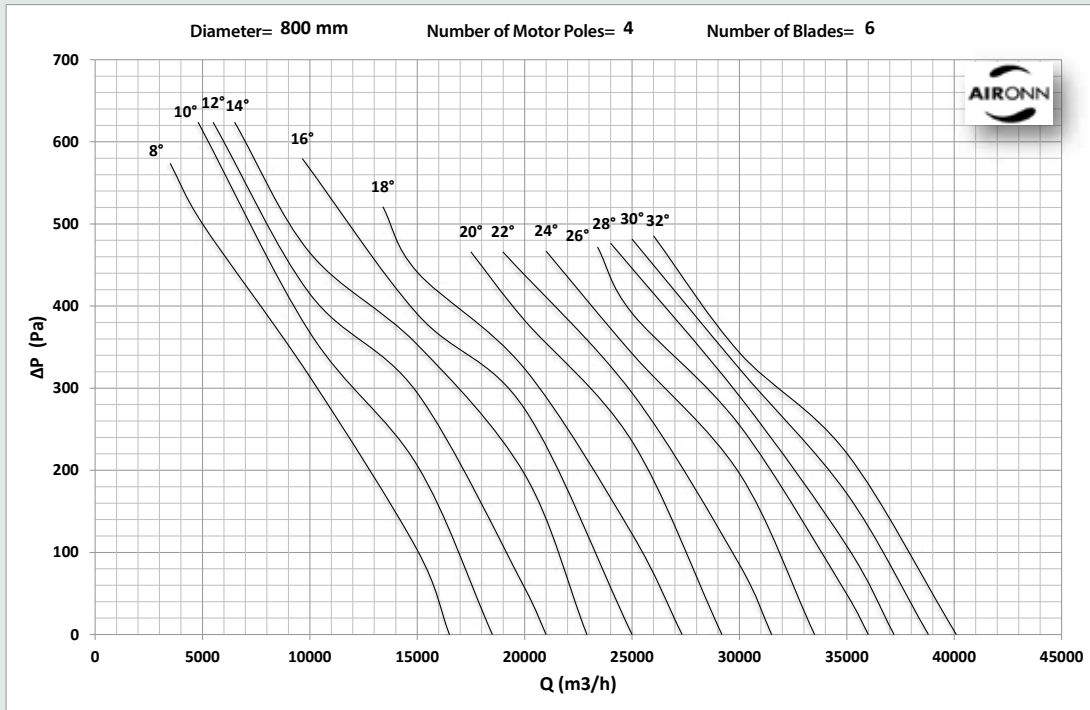

# Lobby Type Axial Fresh Air Fan Series for Roofs

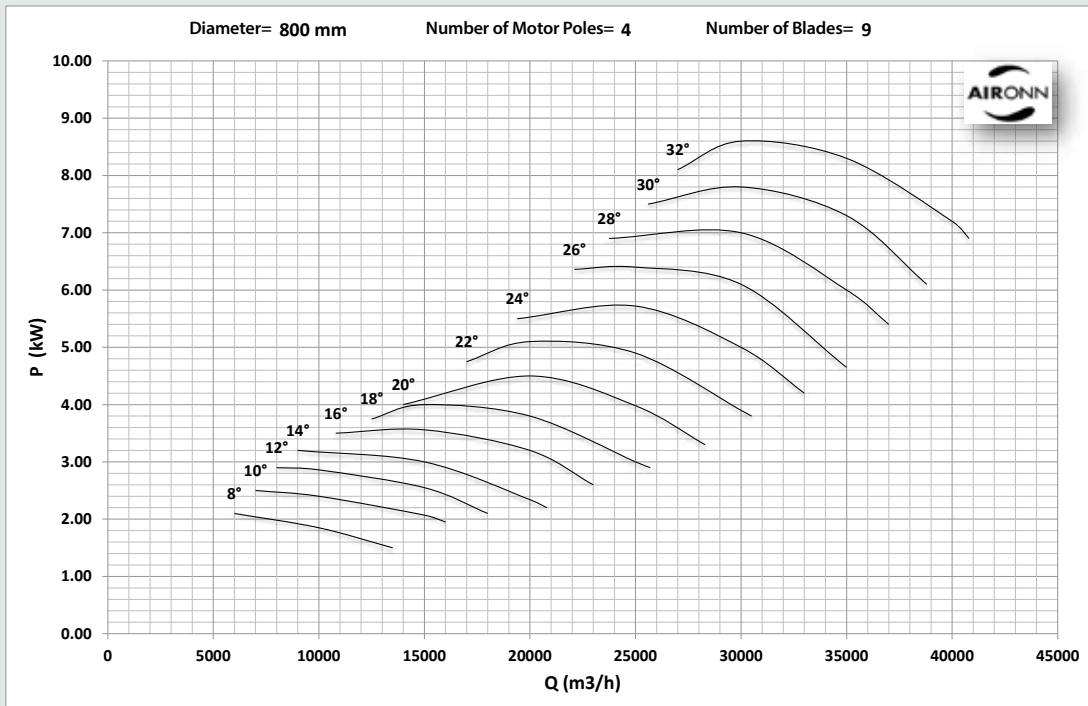
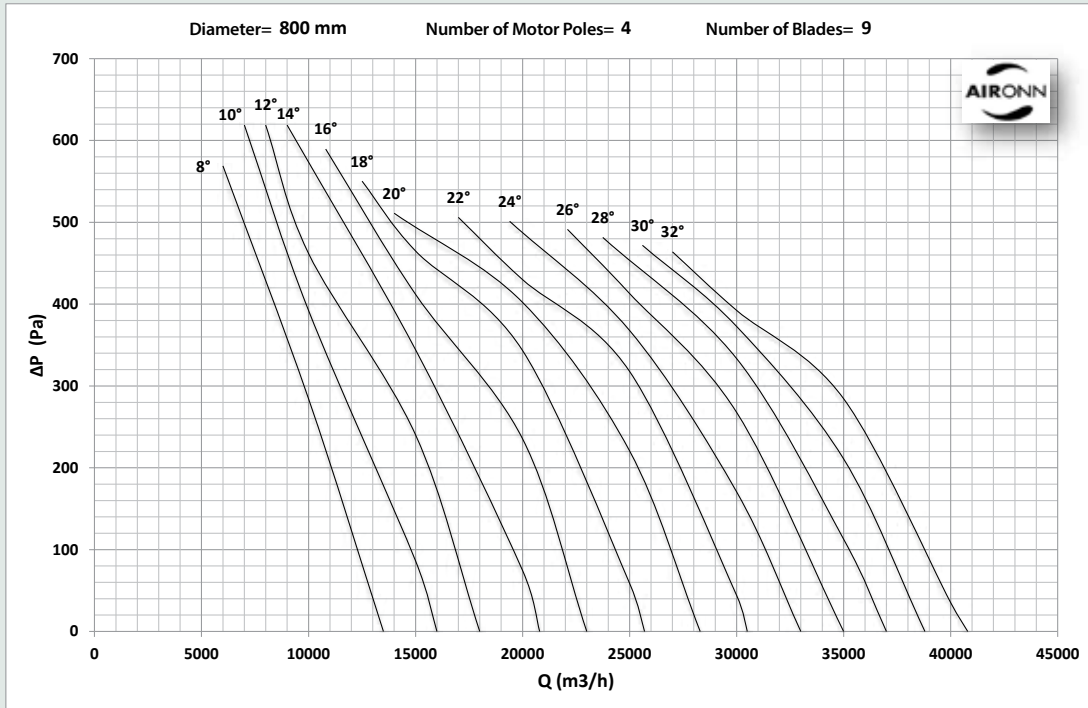

# Lobby Type Axial Fresh Air Fan Series for Roofs

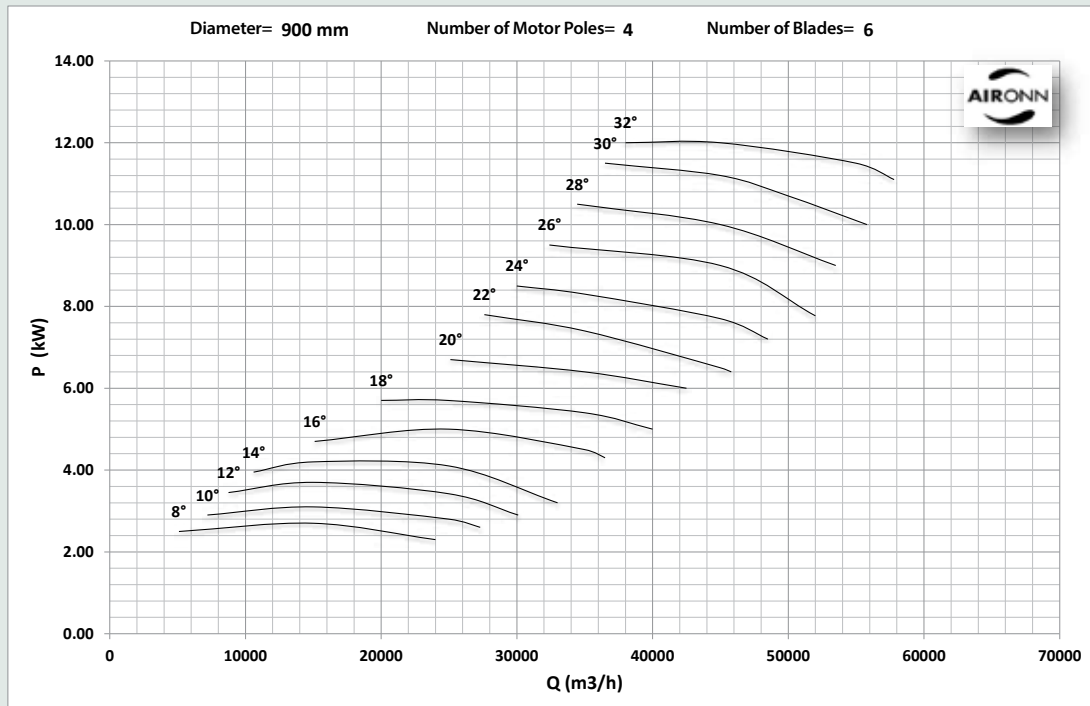
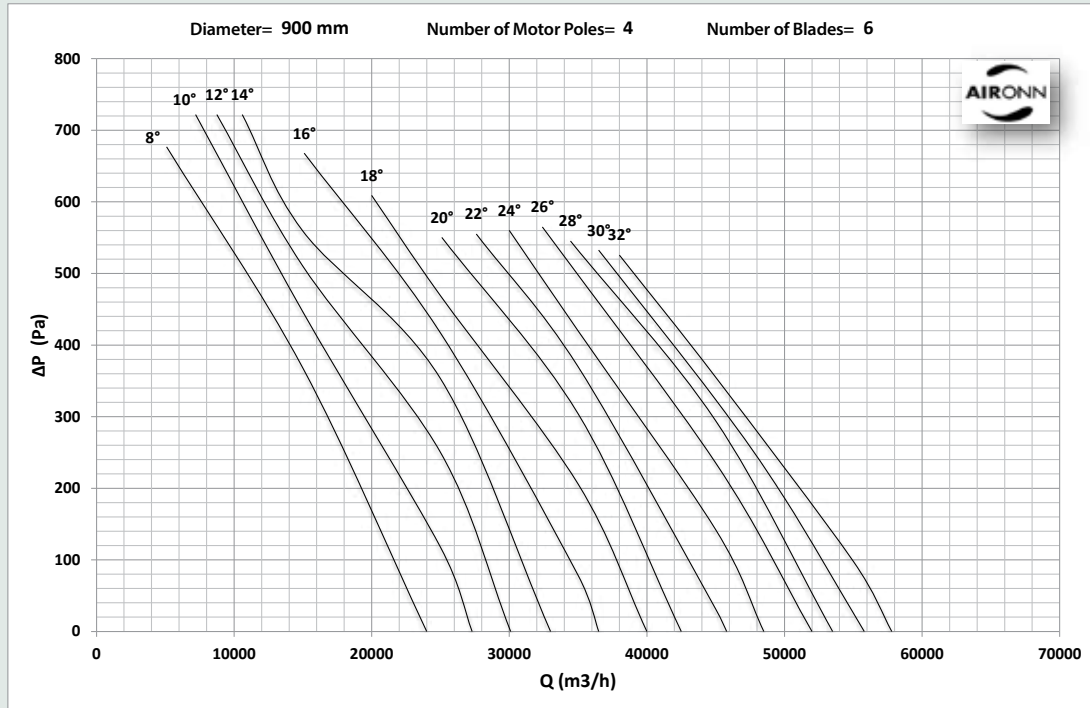

# Lobby Type Axial Fresh Air Fan Series for Roofs

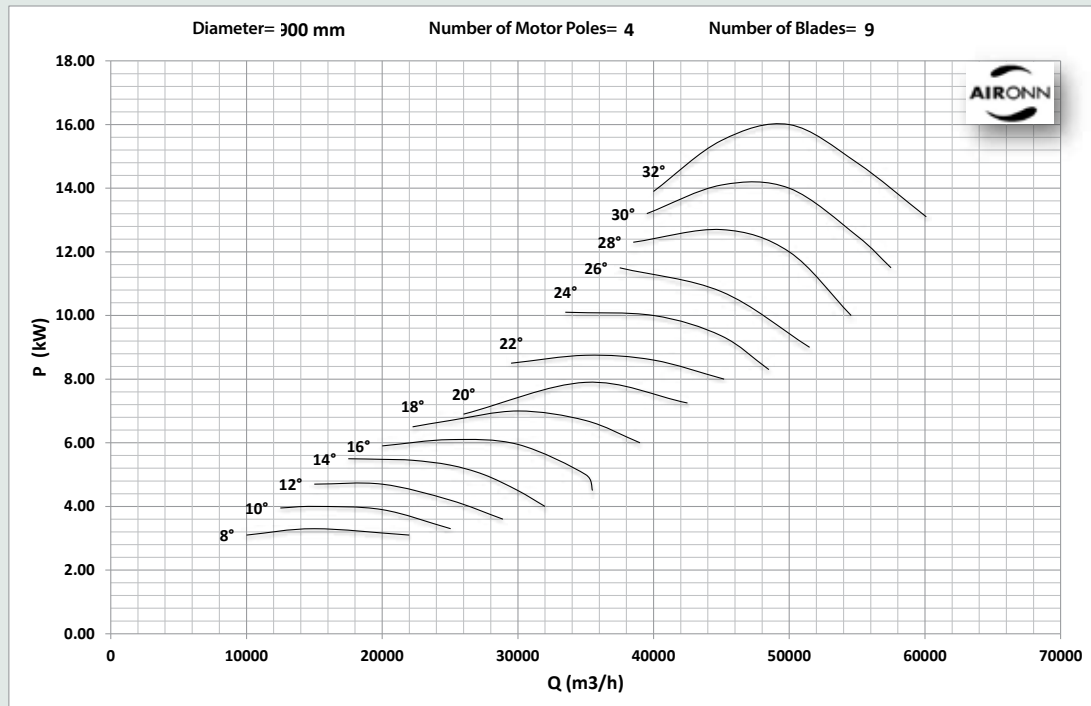
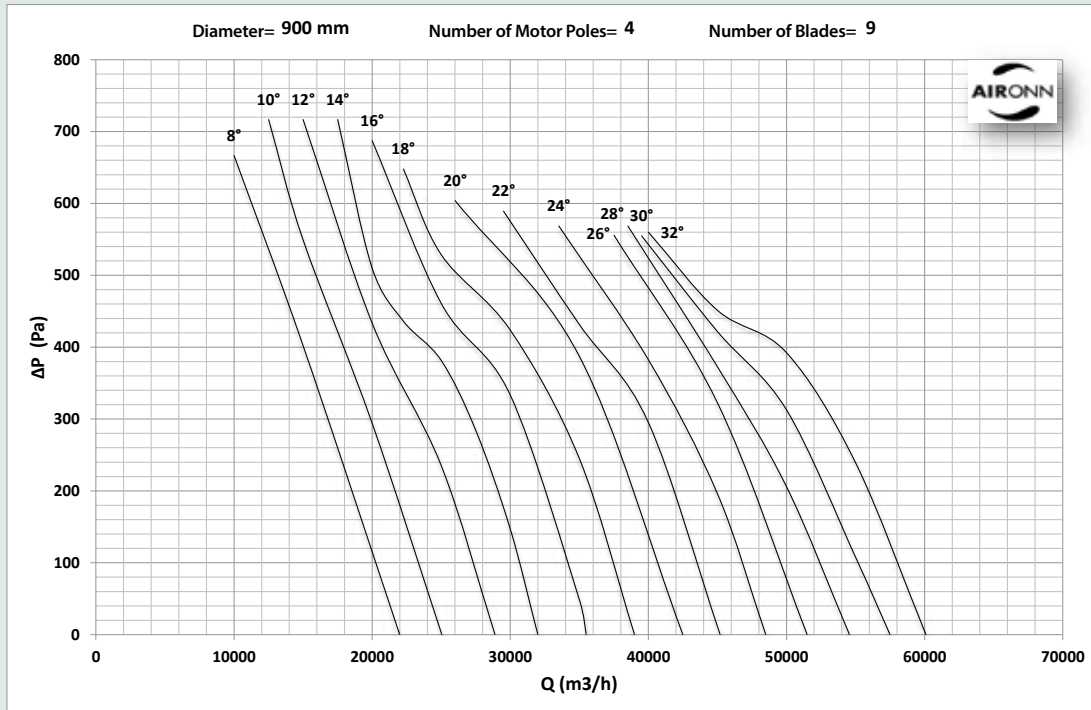

# Lobby Type Axial Fresh Air Fan Series for Roofs

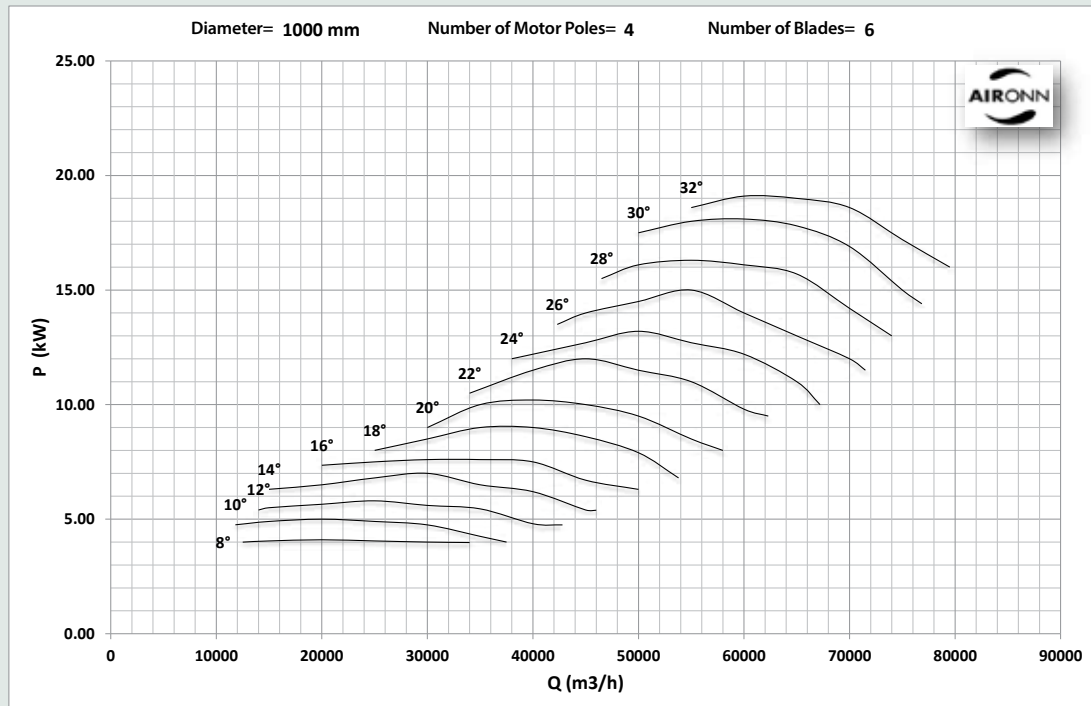
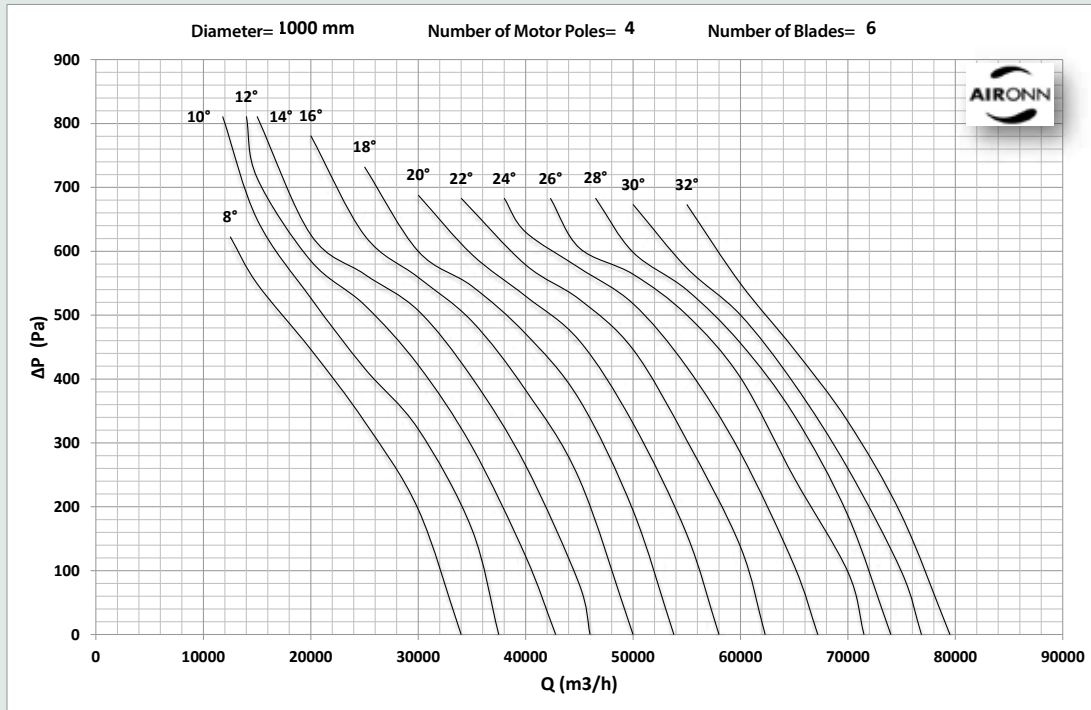



# Lobby Type Axial Fresh Air Fan Series for Roofs

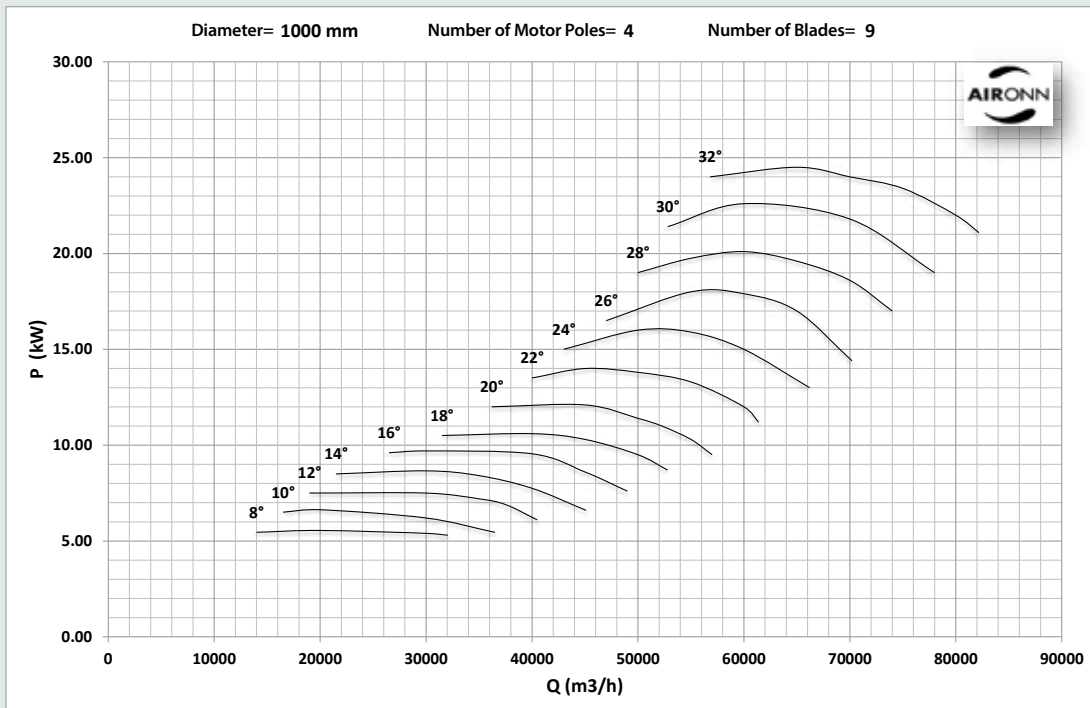
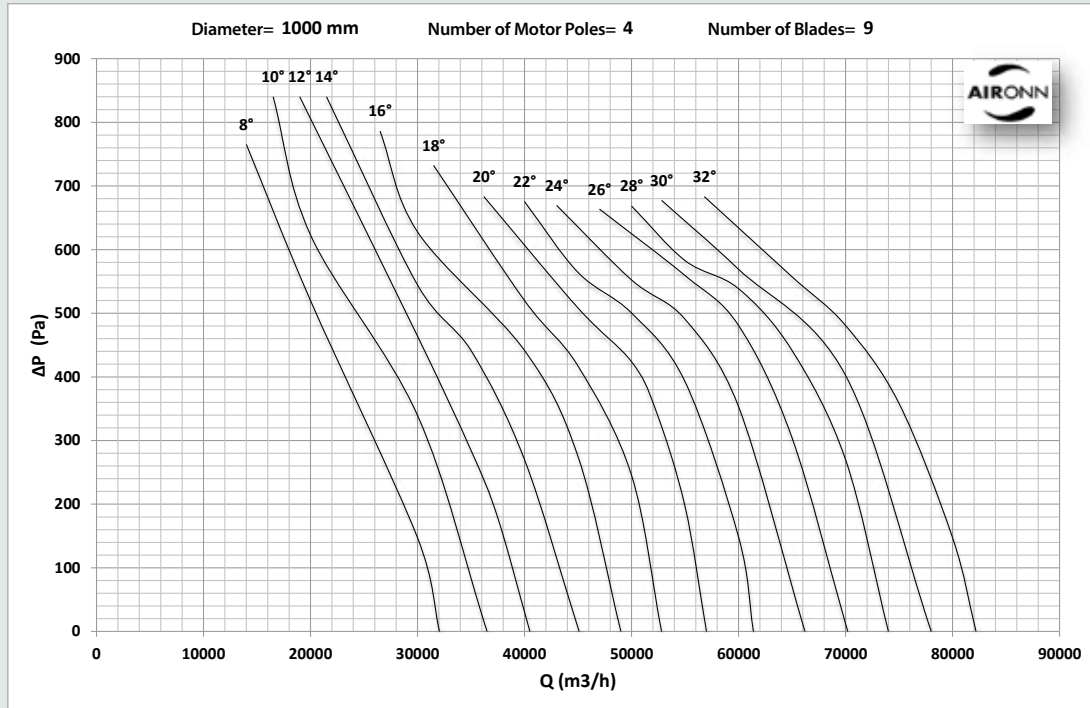

# Lobby Type Axial Fresh Air Fan Series for Roofs

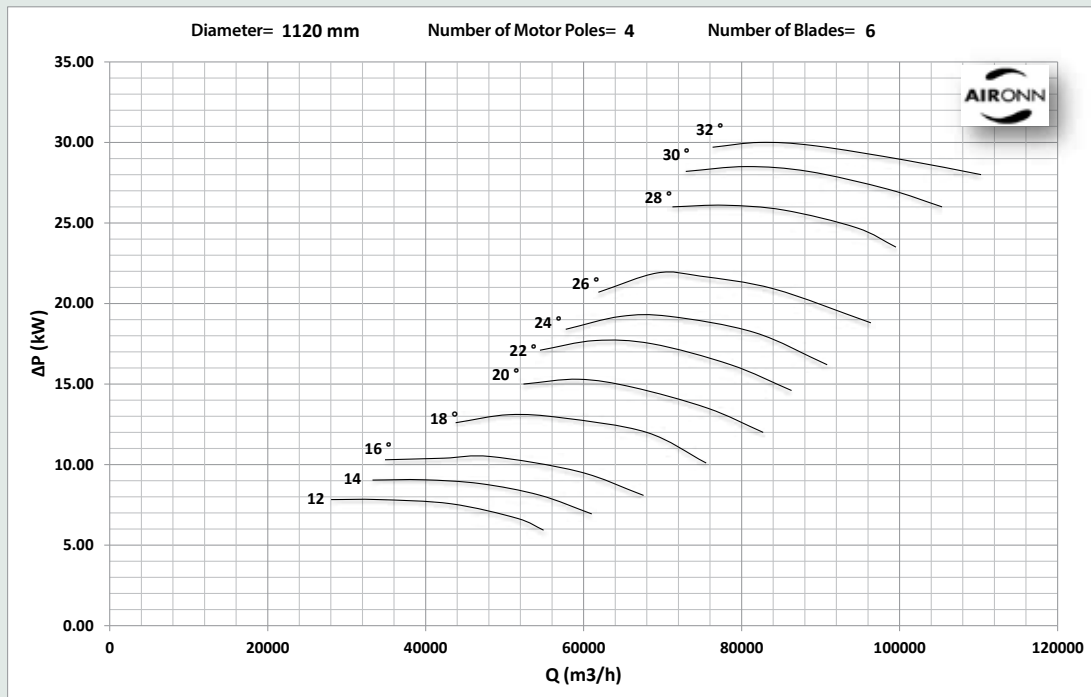
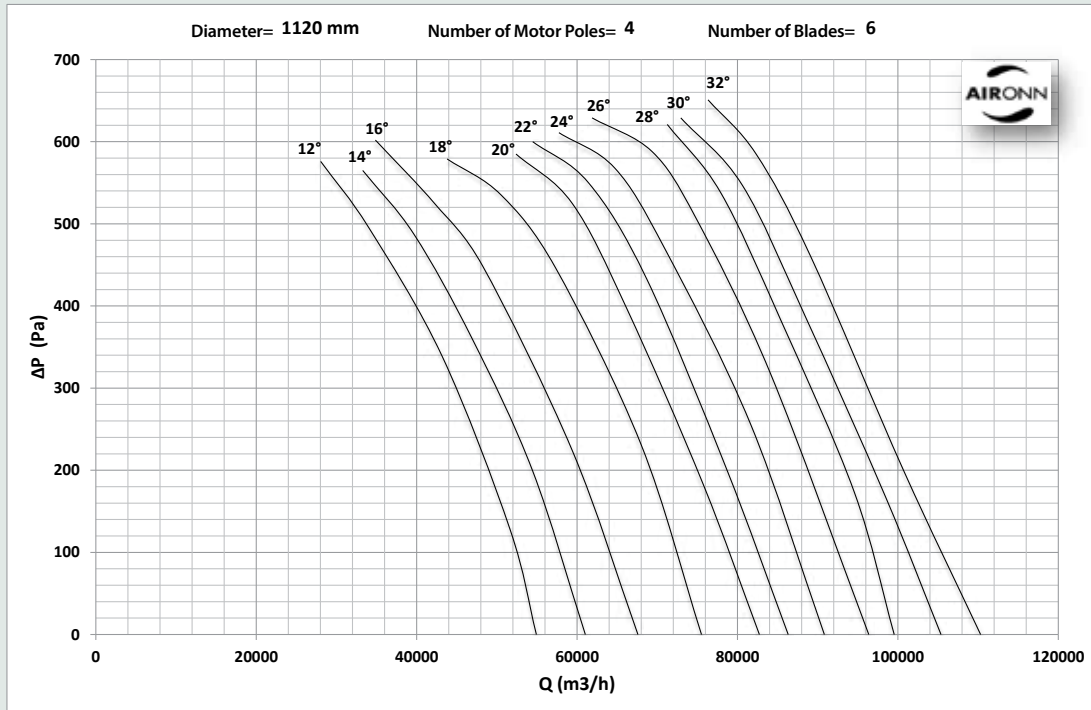

# Lobby Type Axial Fresh Air Fan Series for Roofs

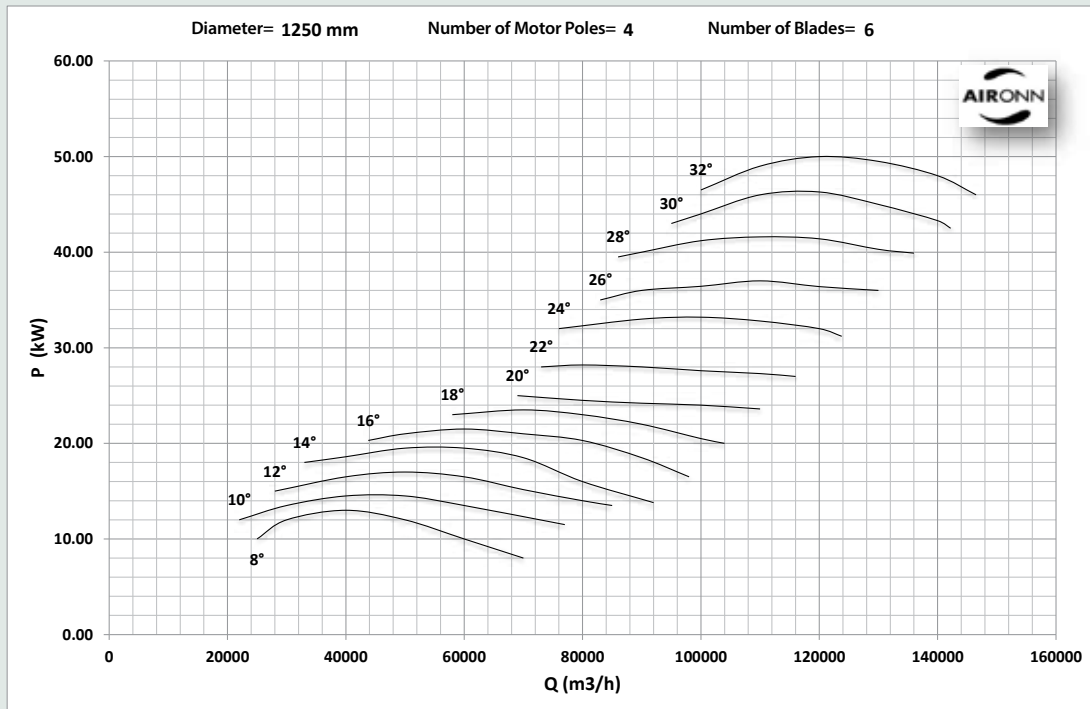
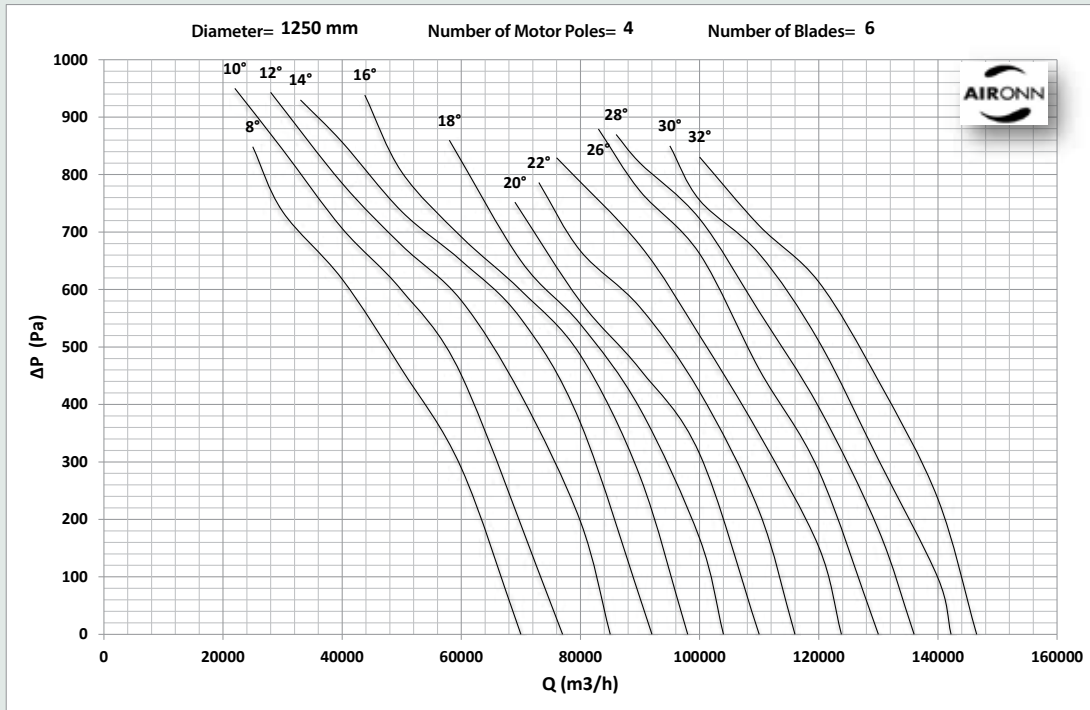

# Lobby Type Axial Fresh Air Fan Series for Roofs

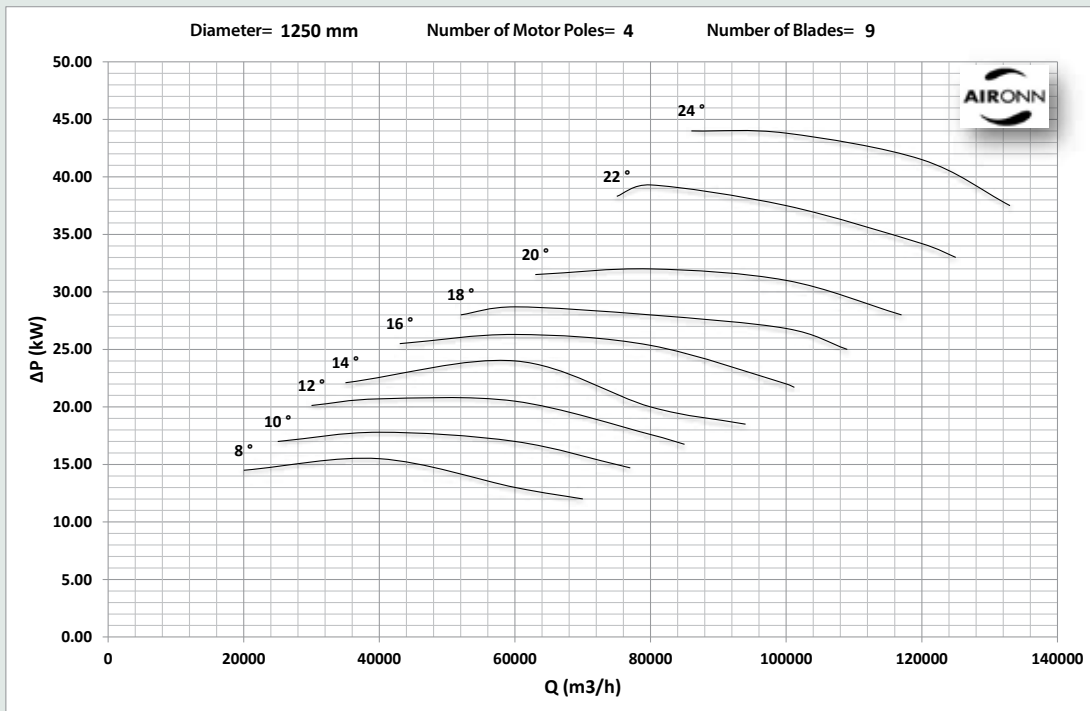
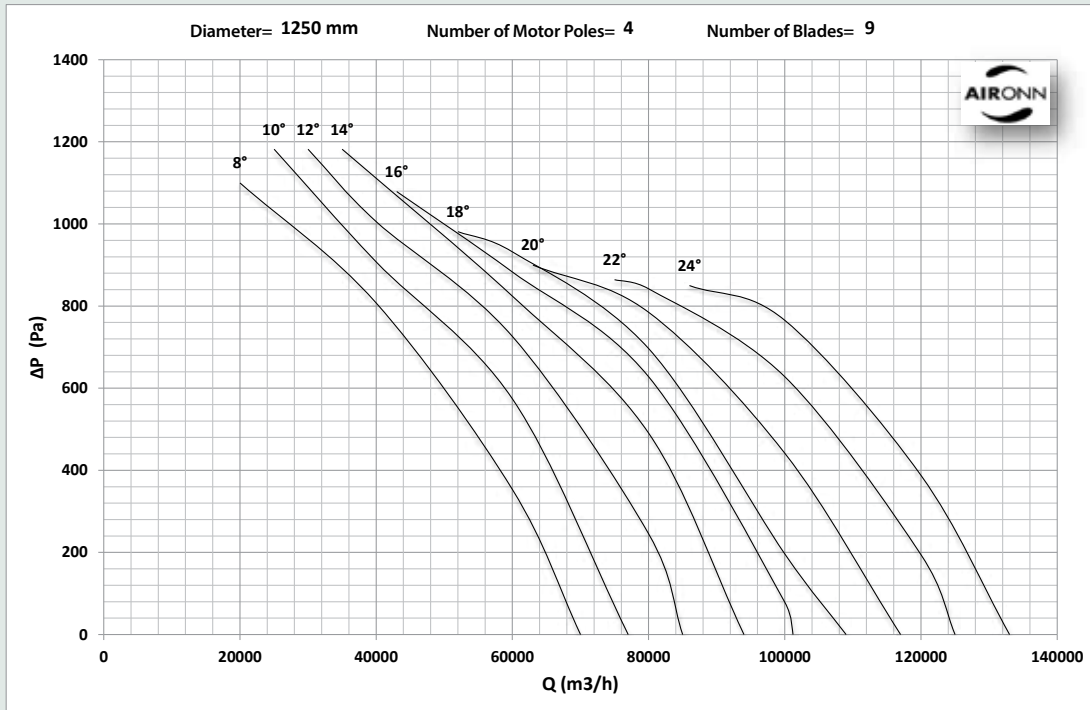

# Lobby Type Axial Smoke Exhaust Fan Series for Roofs

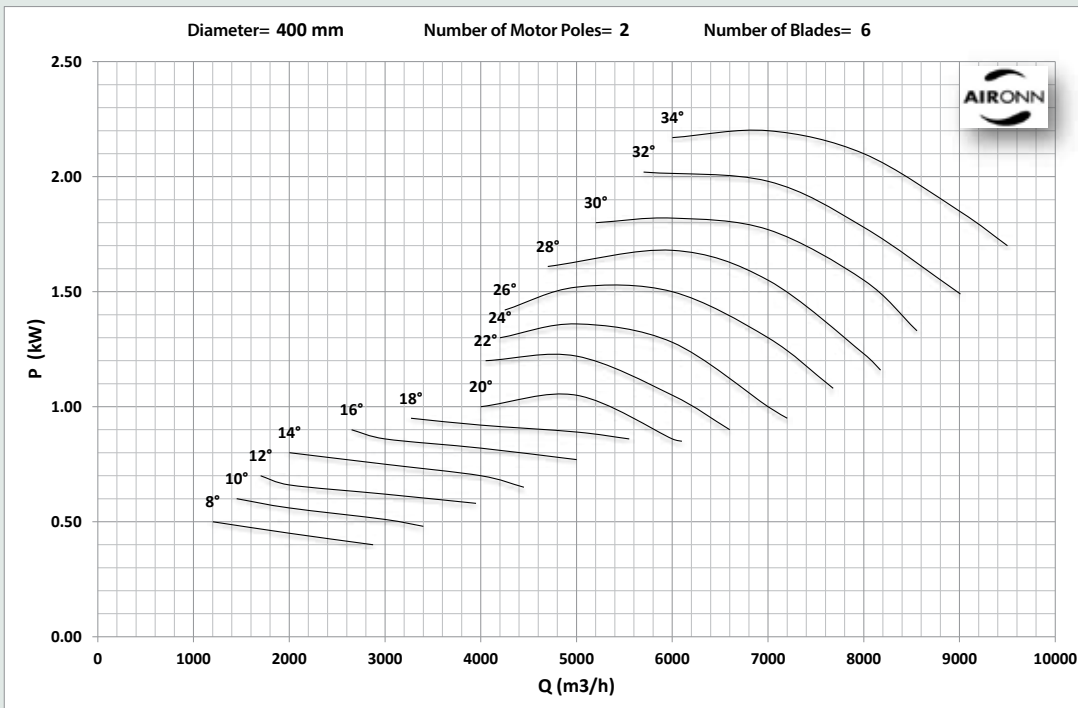
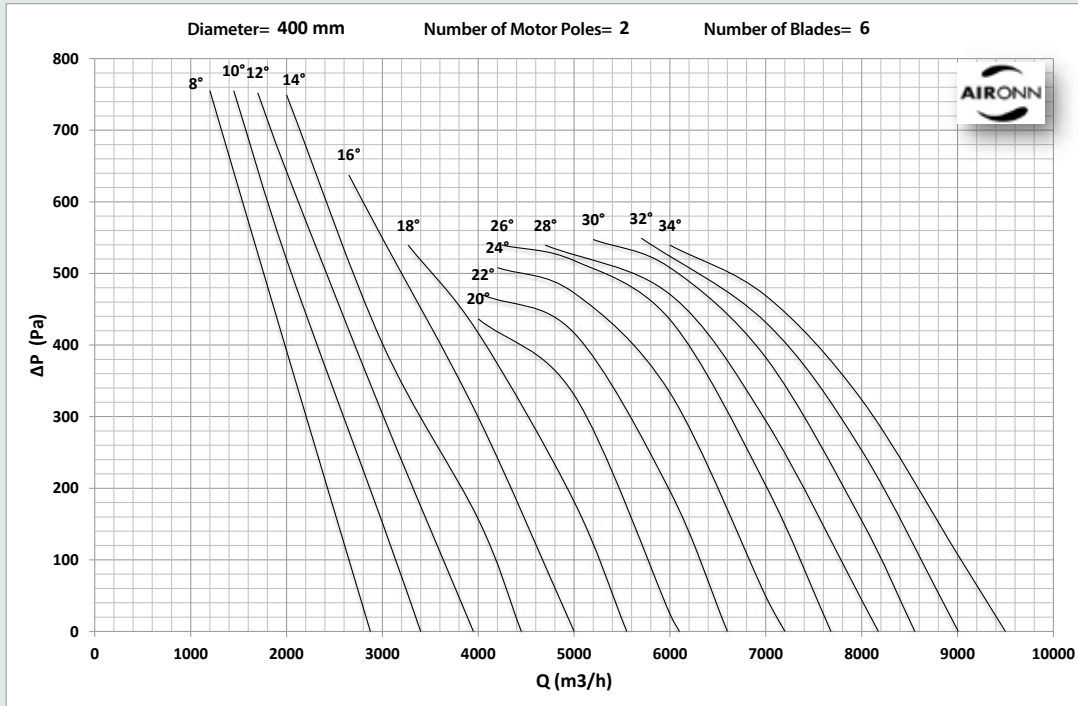

# Lobby Type Axial Smoke Exhaust Fan Series for Roofs

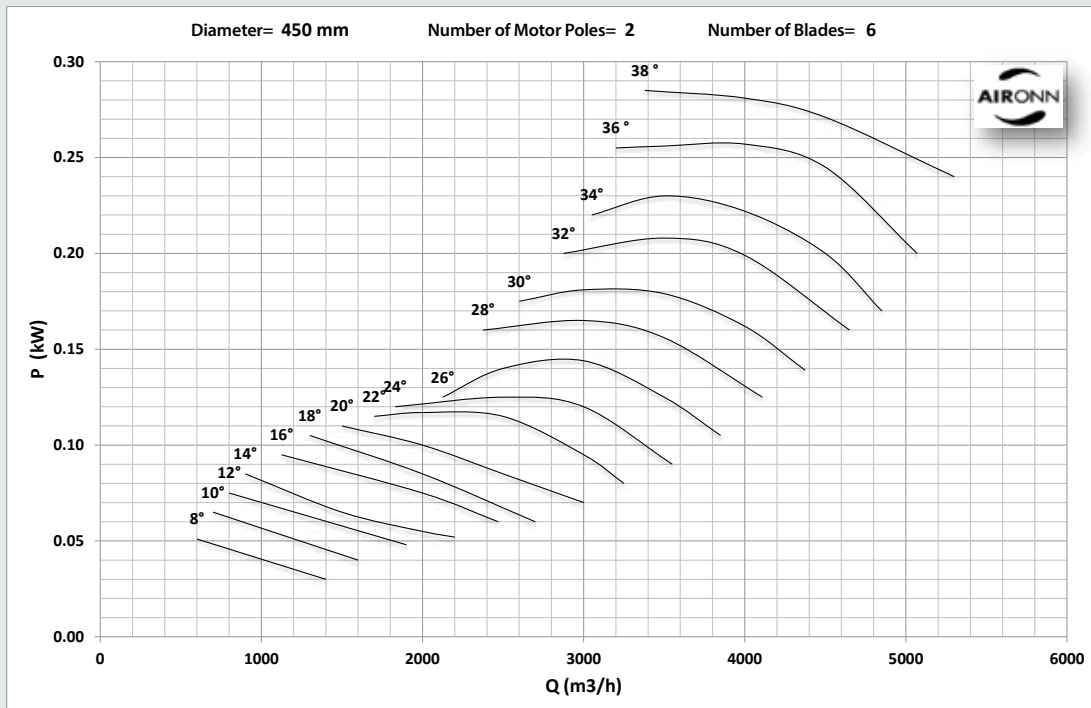
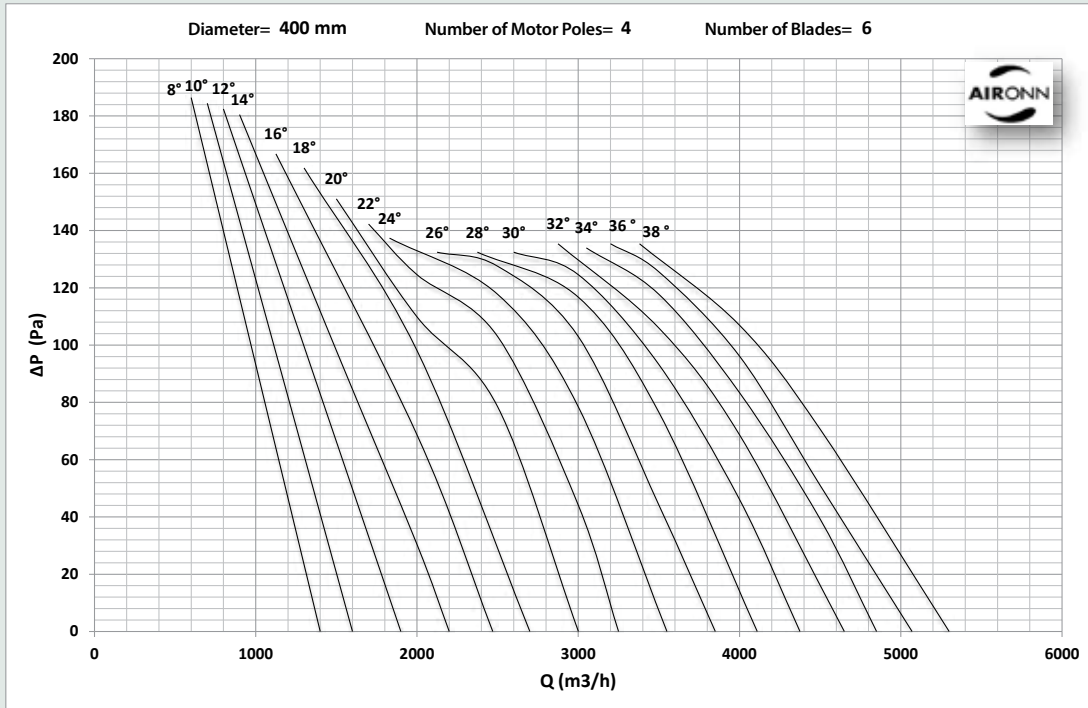

# Lobby Type Axial Smoke Exhaust Fan Series for Roofs

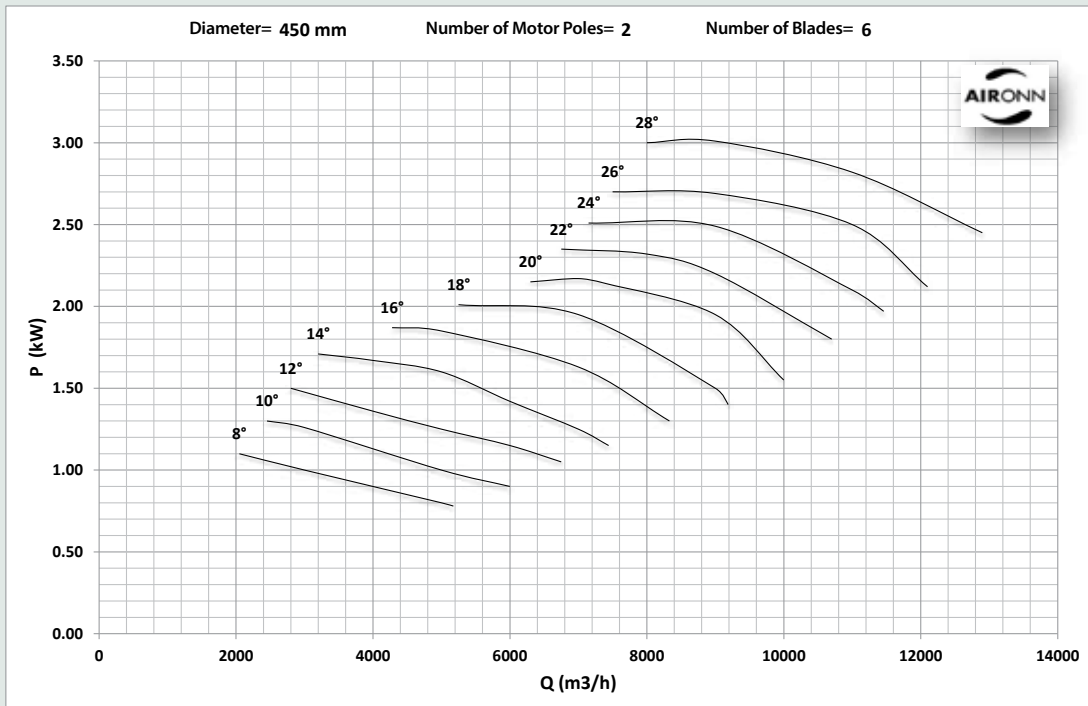
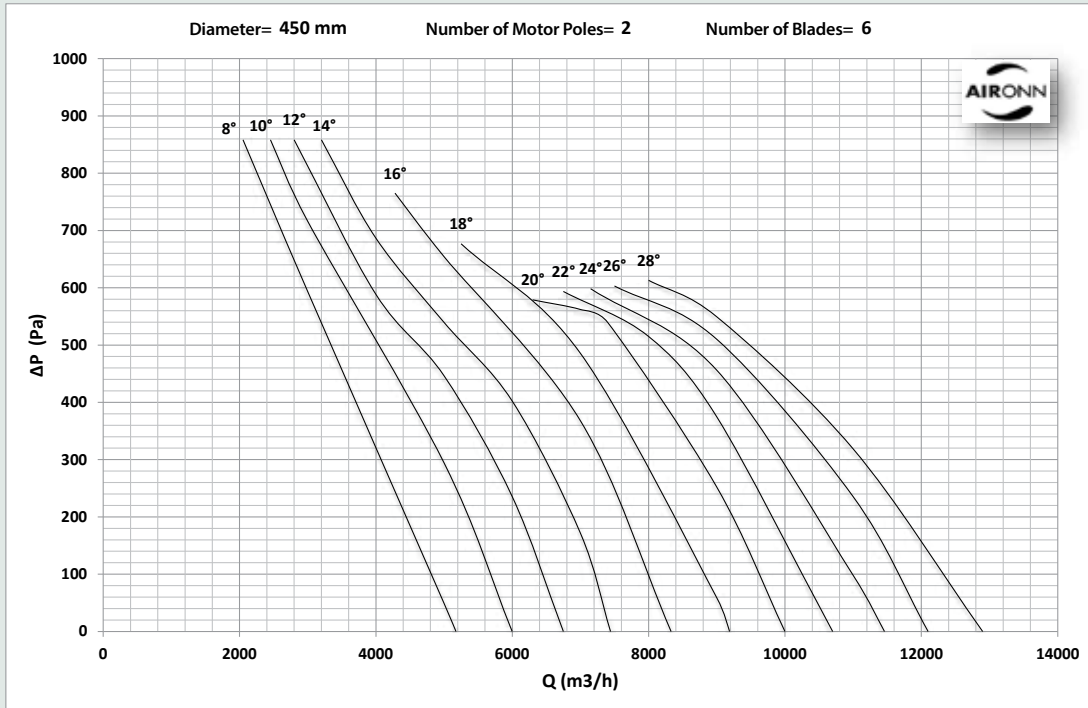

# Lobby Type Axial Smoke Exhaust Fan Series for Roofs

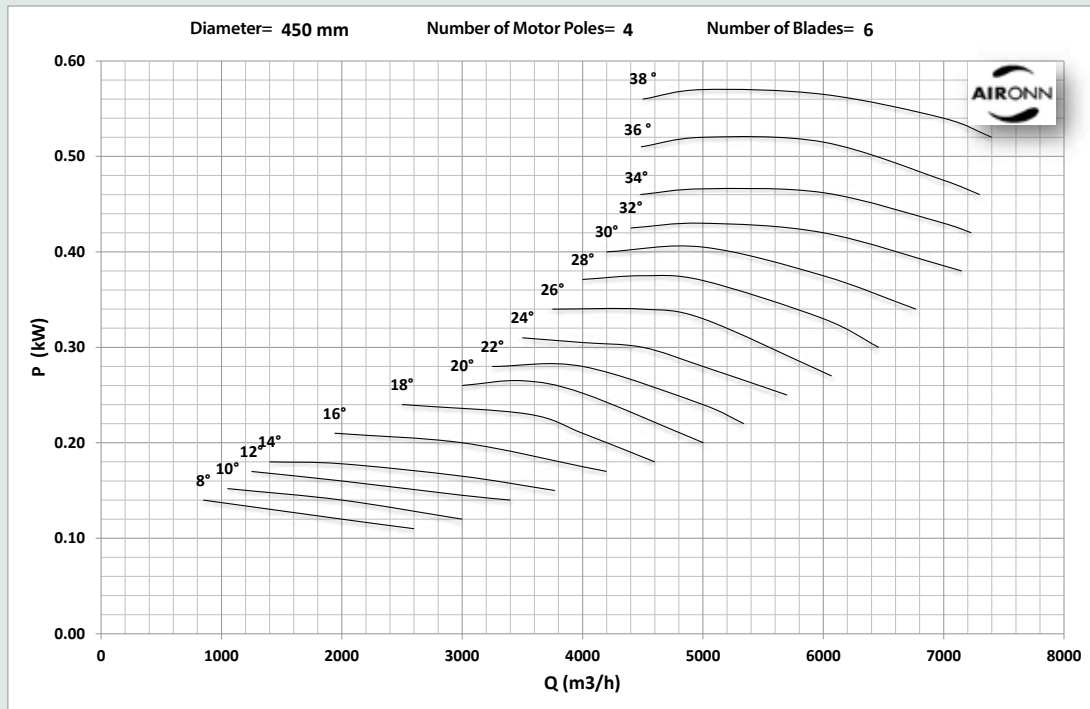
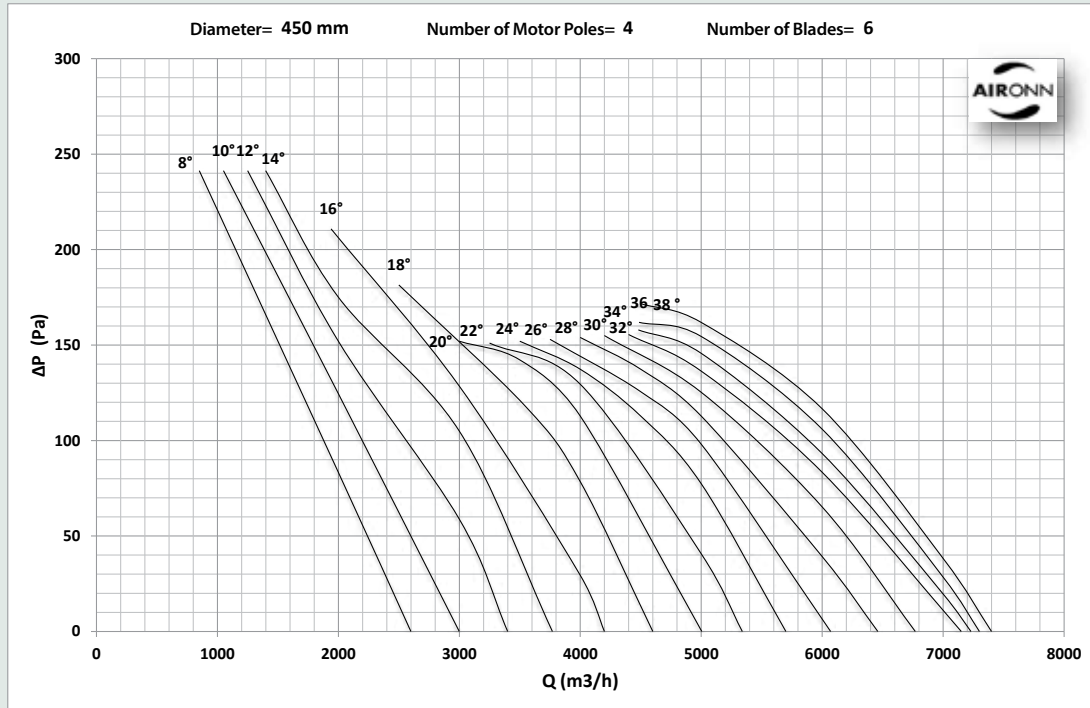



# Lobby Type Axial Smoke Exhaust Fan Series for Roofs

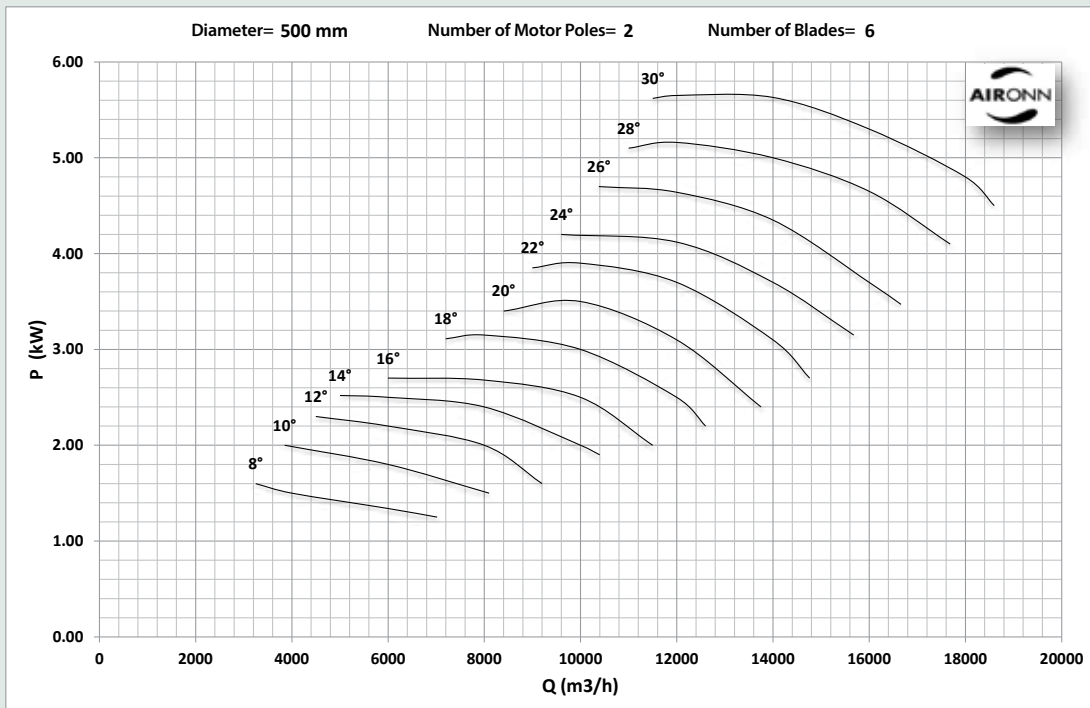
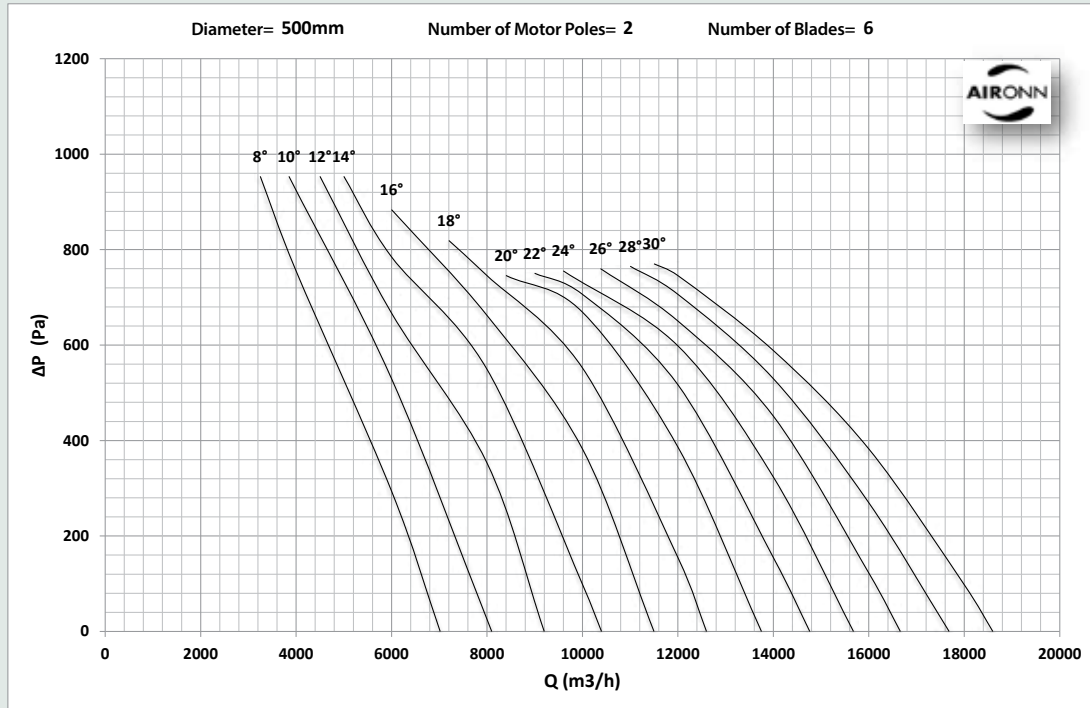

# Lobby Type Axial Smoke Exhaust Fan Series for Roofs

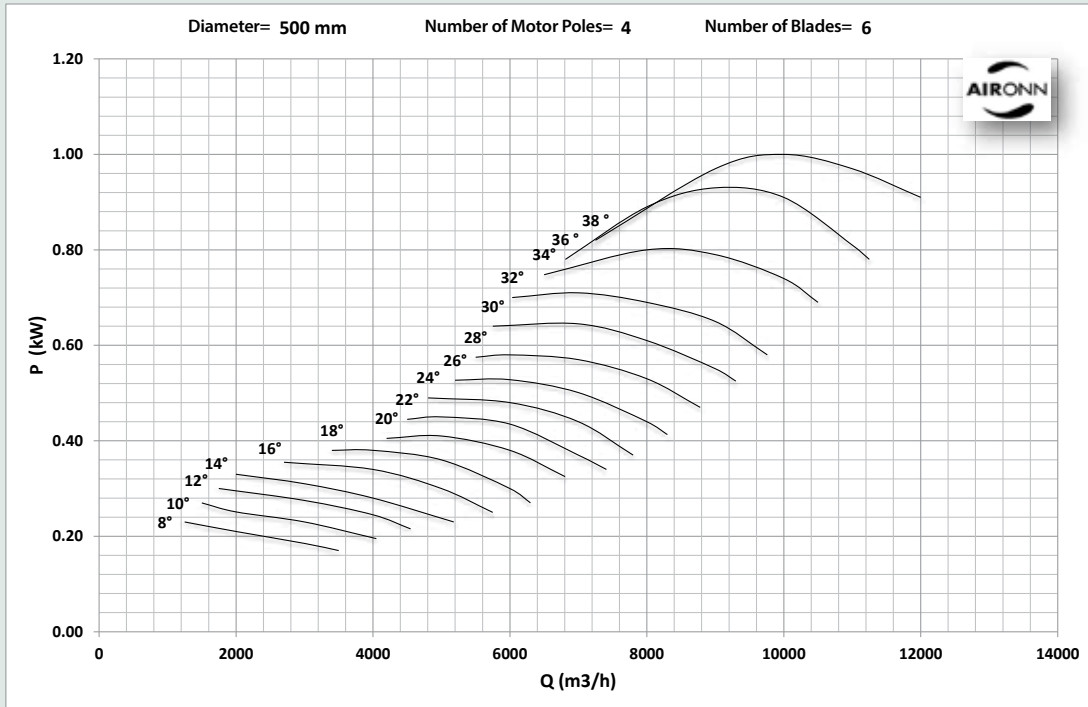
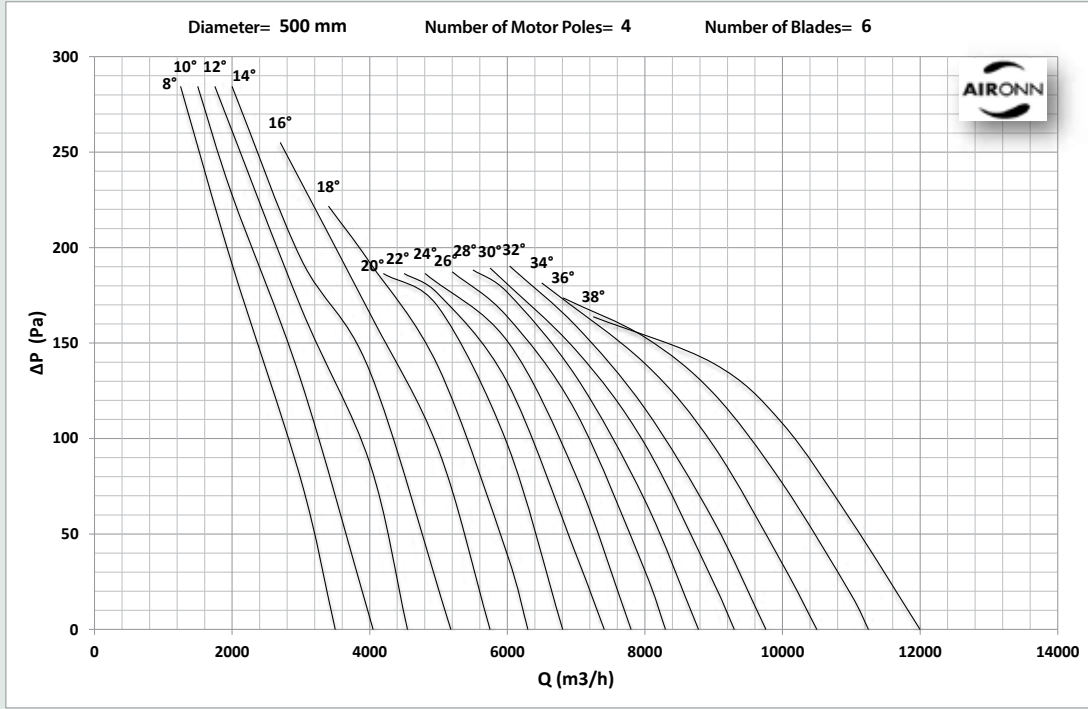

# Lobby Type Axial Smoke Exhaust Fan Series for Roofs

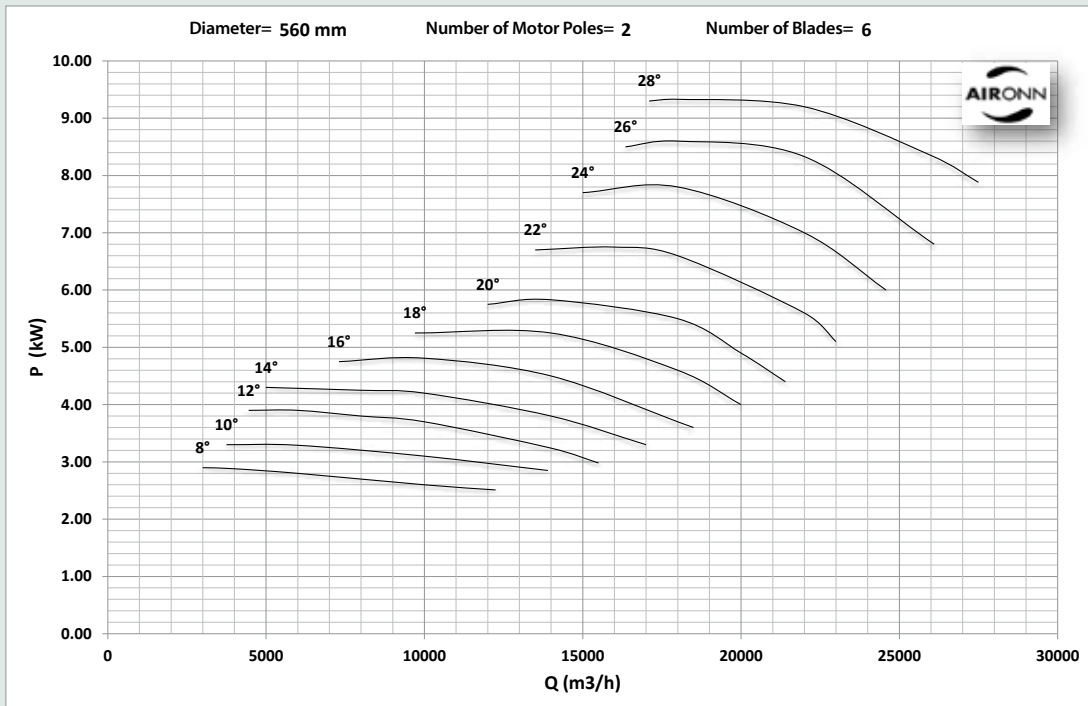
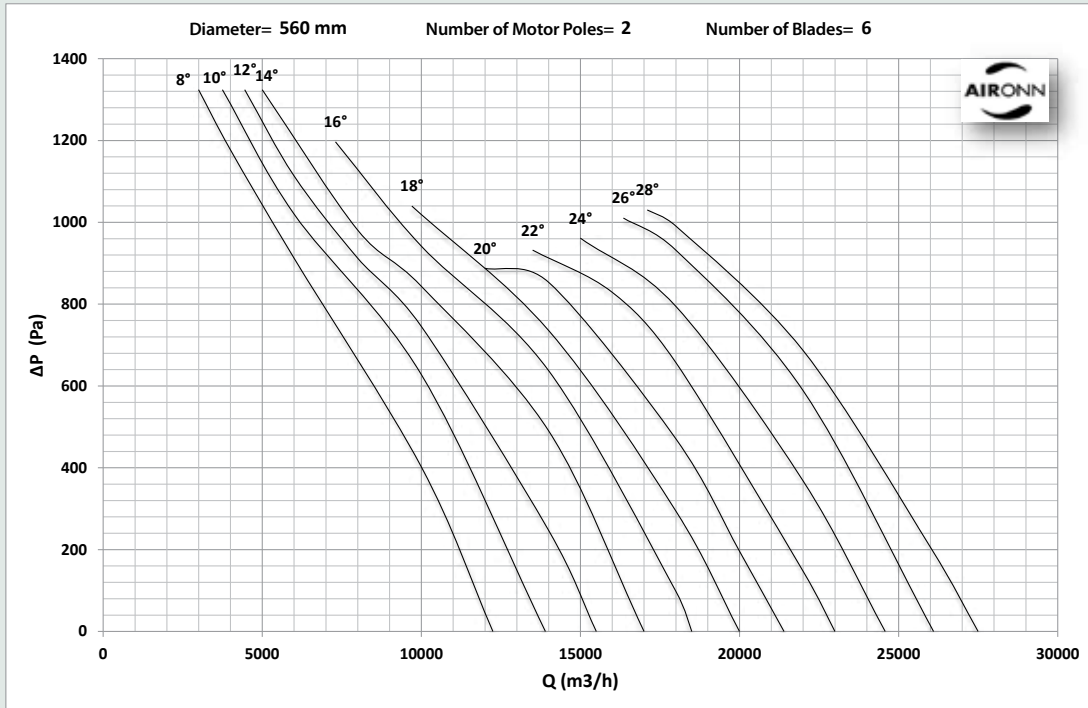

# Lobby Type Axial Smoke Exhaust Fan Series for Roofs

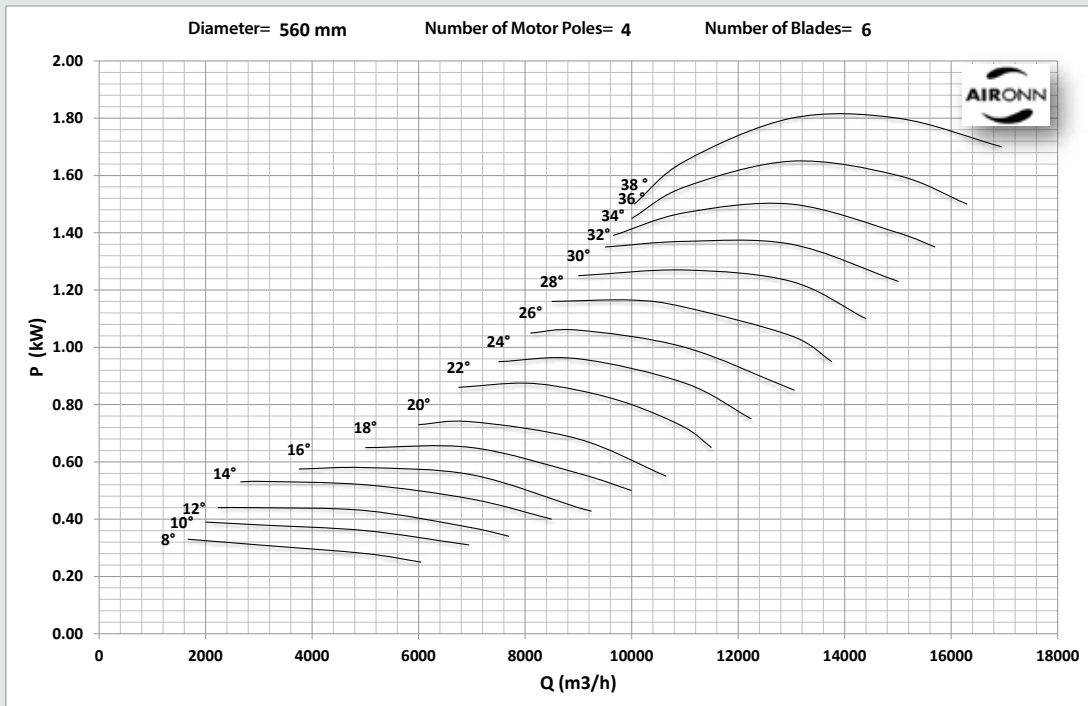
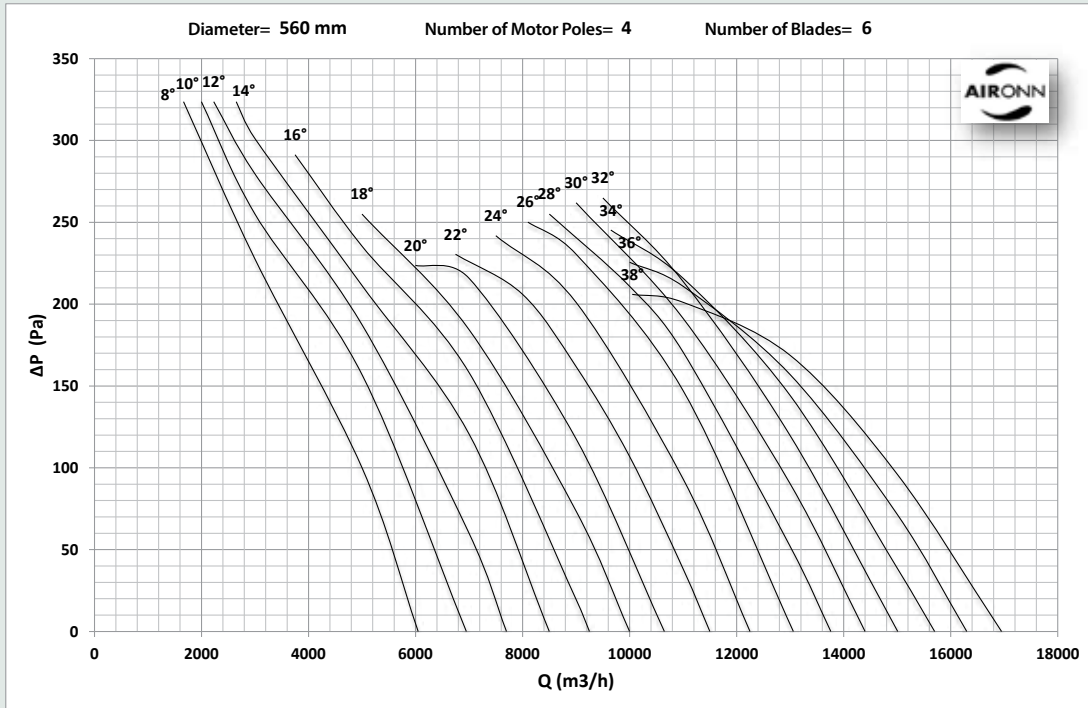

# Lobby Type Axial Smoke Exhaust Fan Series for Roofs

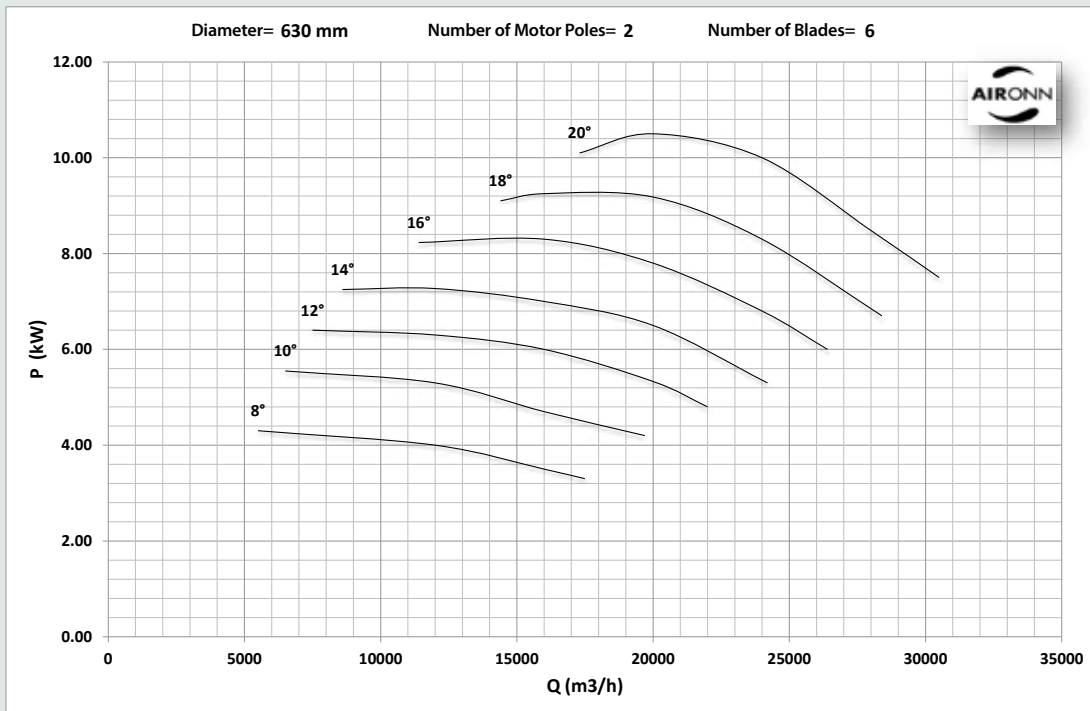
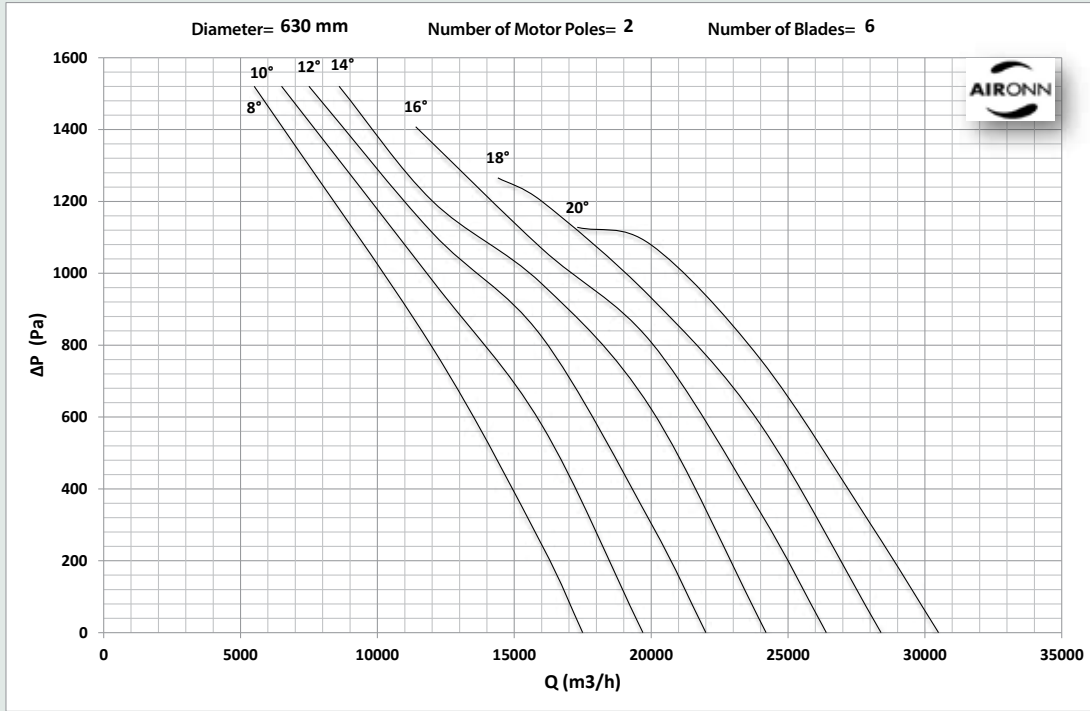

# Lobby Type Axial Smoke Exhaust Fan Series for Roofs

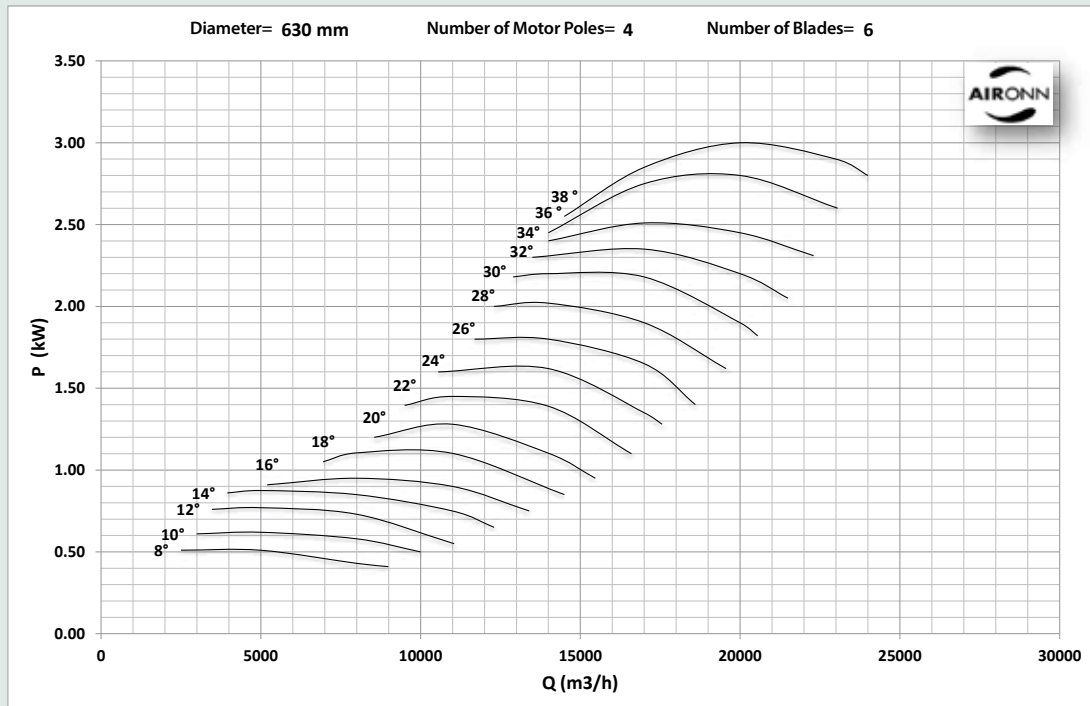
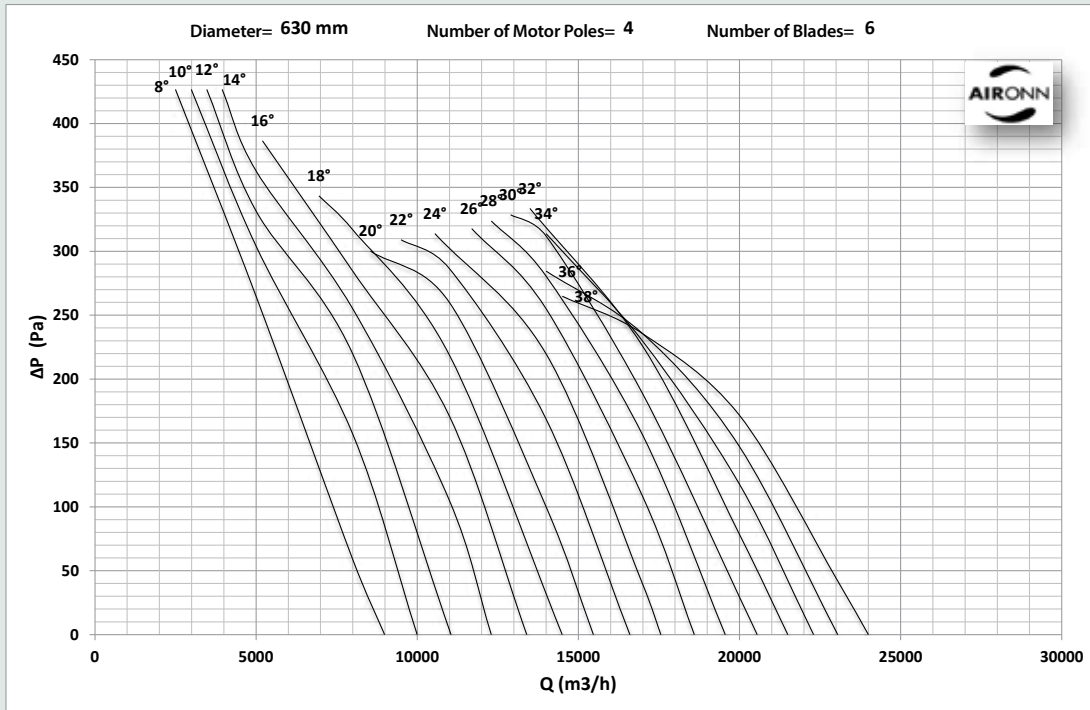

# Lobby Type Axial Smoke Exhaust Fan Series for Roofs

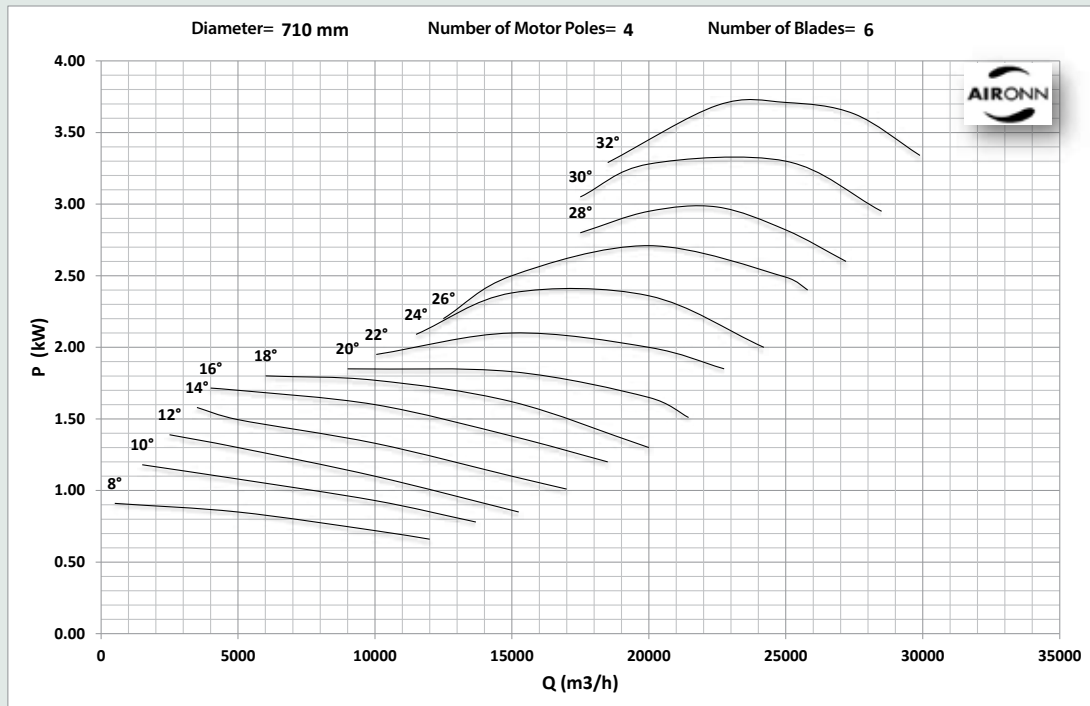
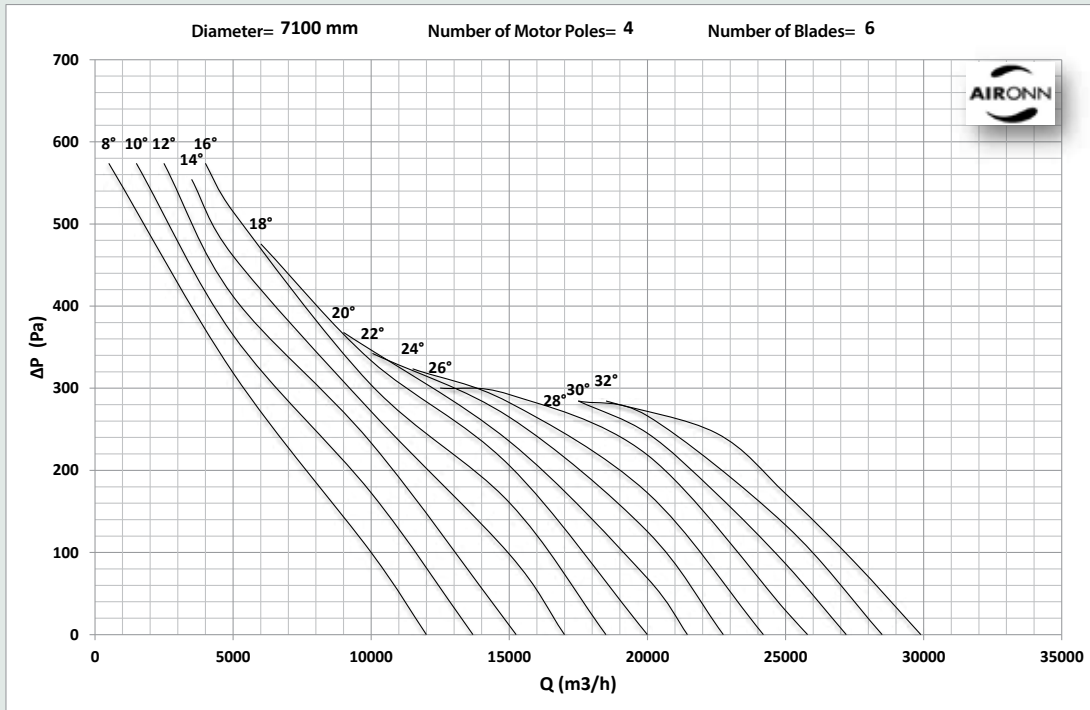

# Lobby Type Axial Smoke Exhaust Fan Series for Roofs

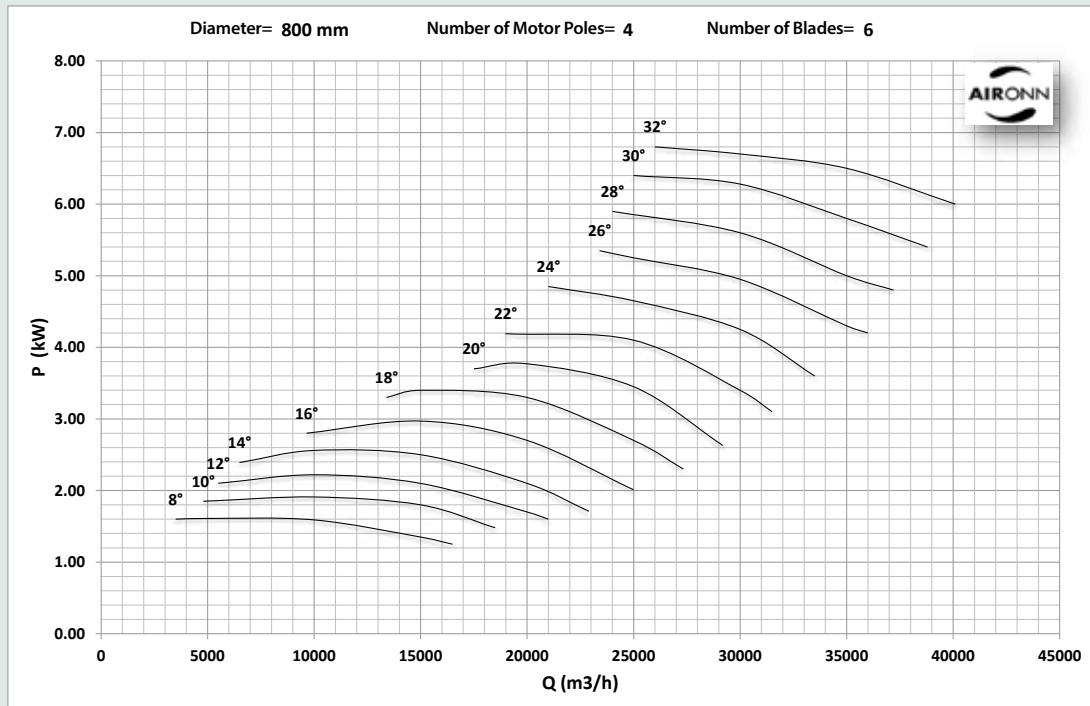
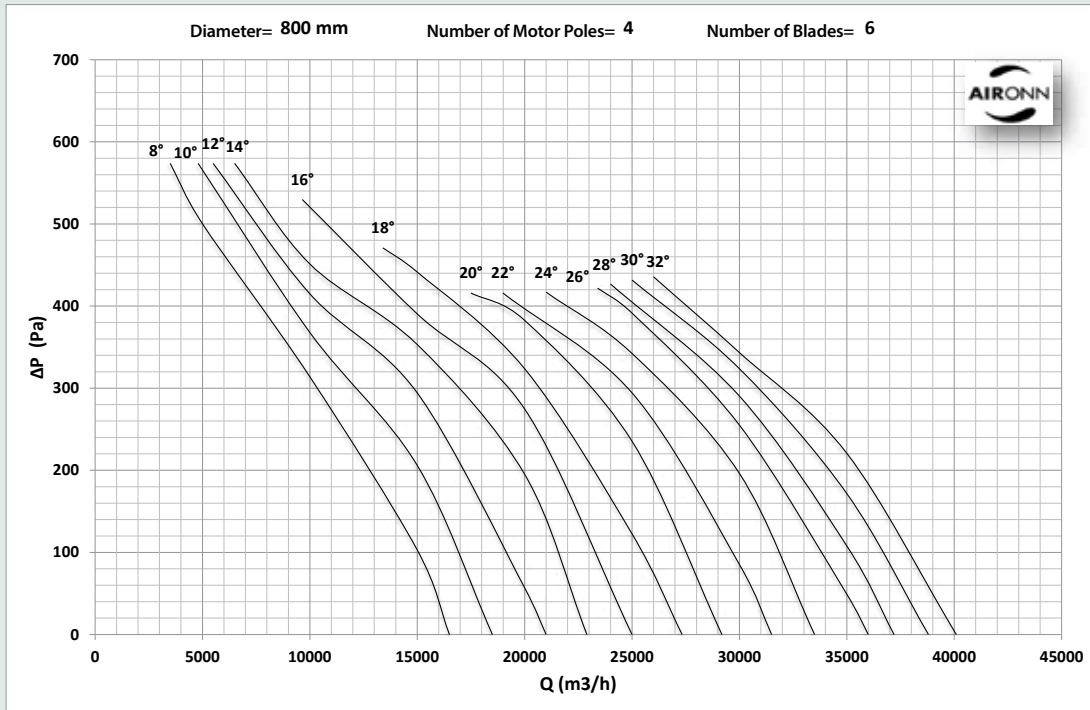



# Lobby Type Axial Smoke Exhaust Fan Series for Roofs

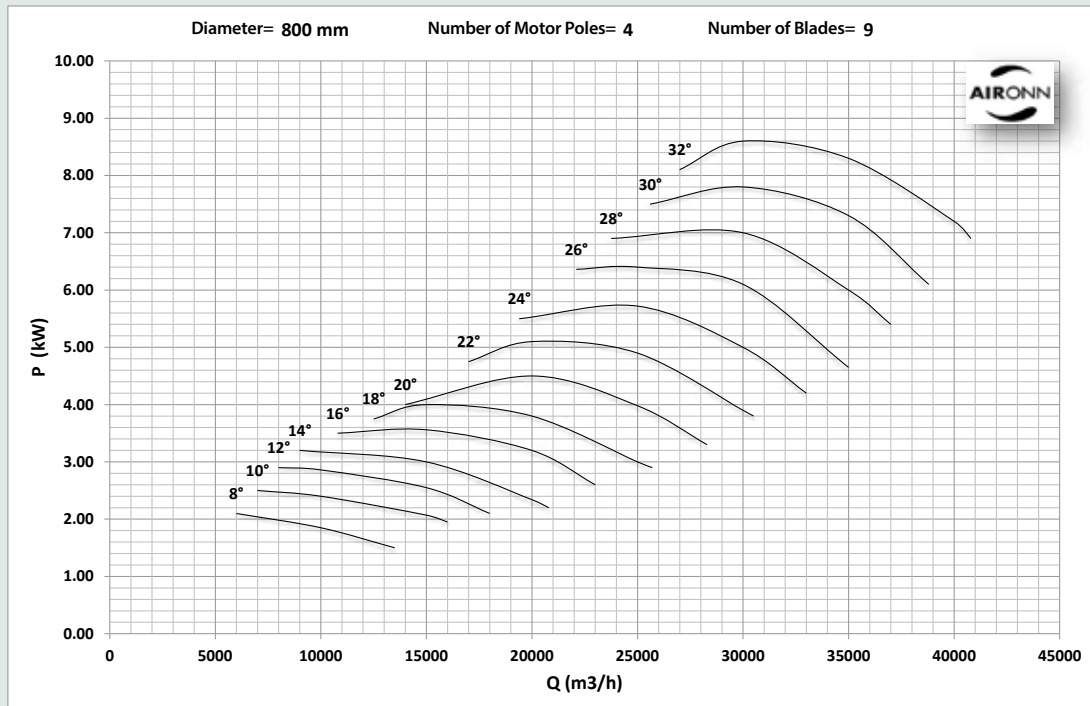
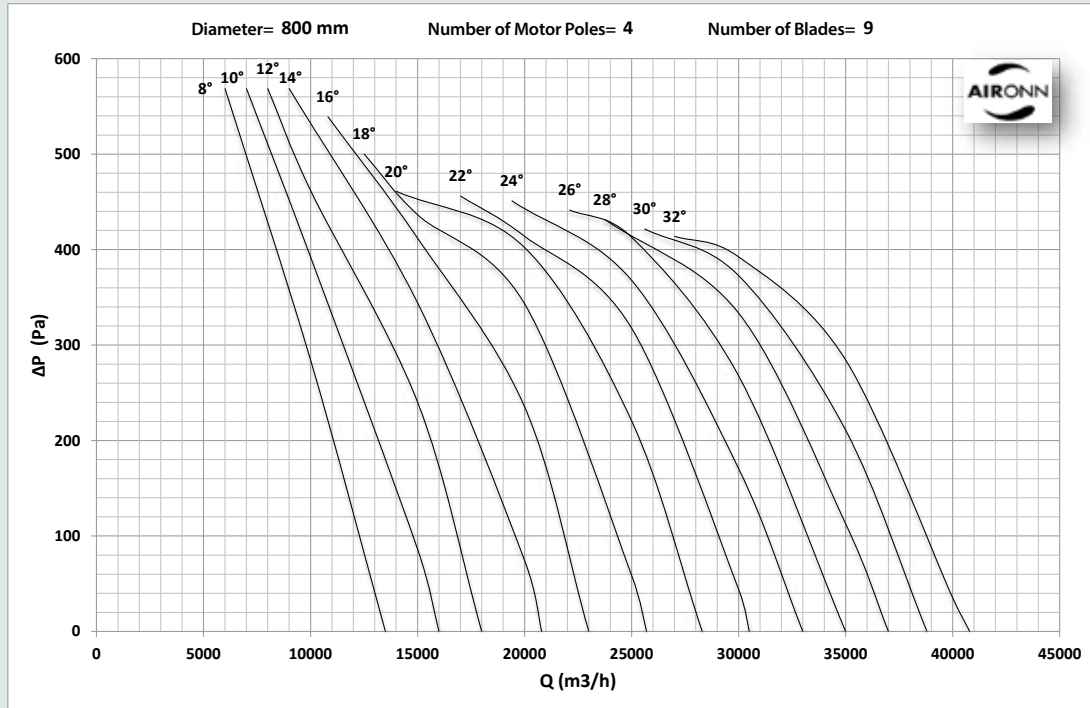

# Lobby Type Axial Smoke Exhaust Fan Series for Roofs

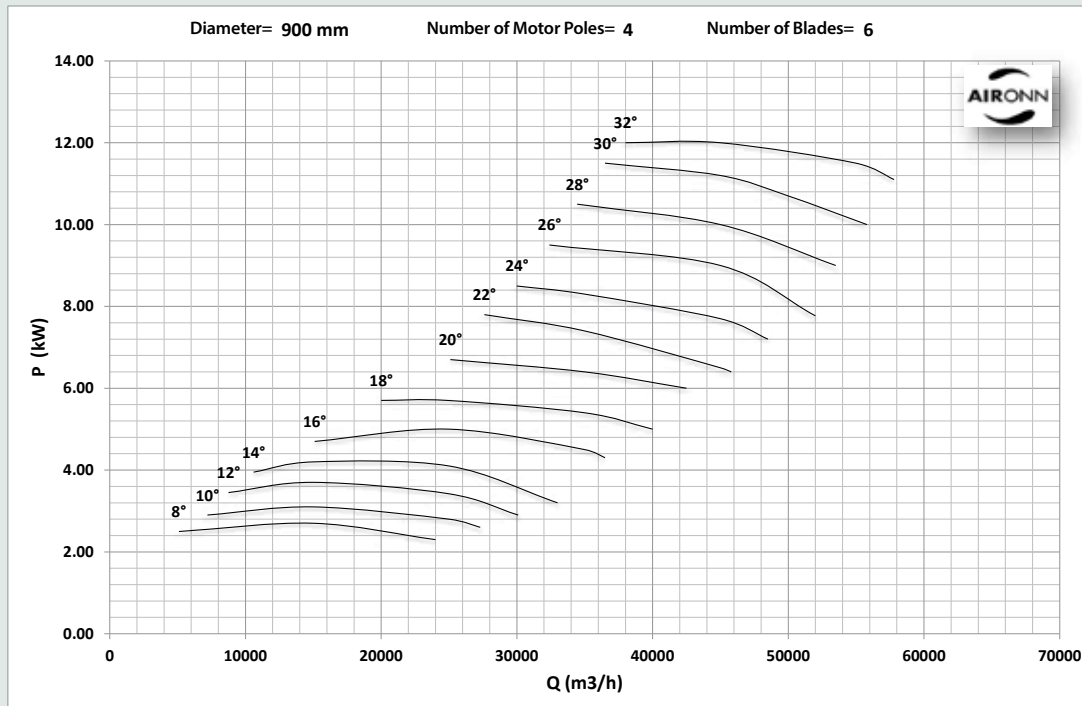
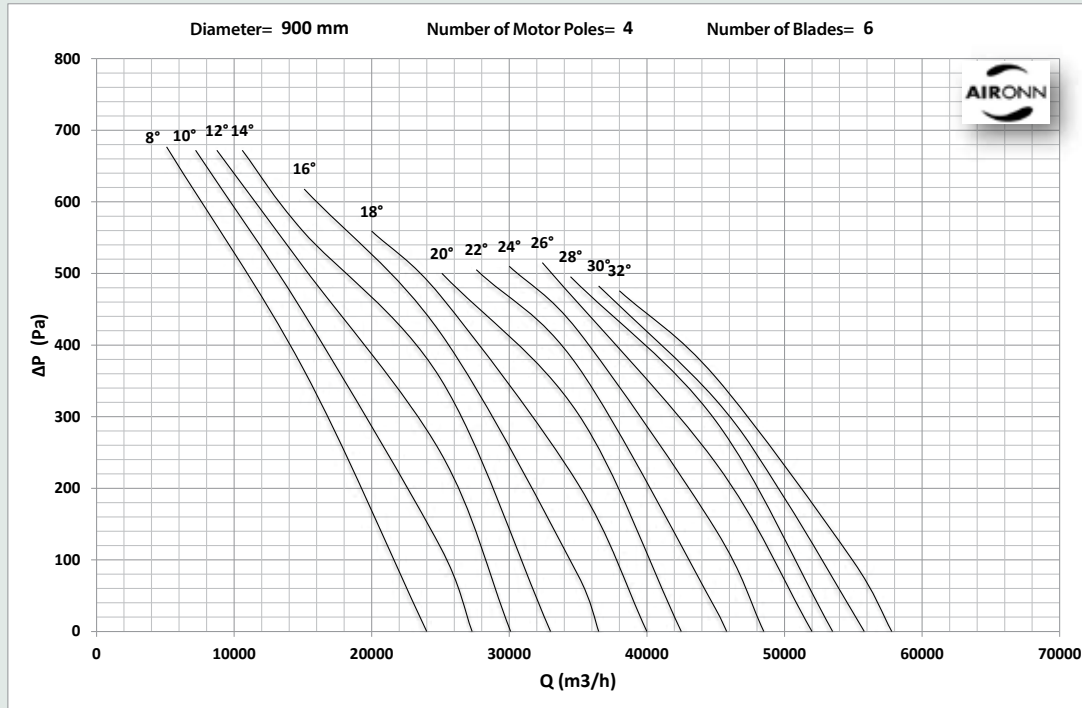

# Lobby Type Axial Smoke Exhaust Fan Series for Roofs

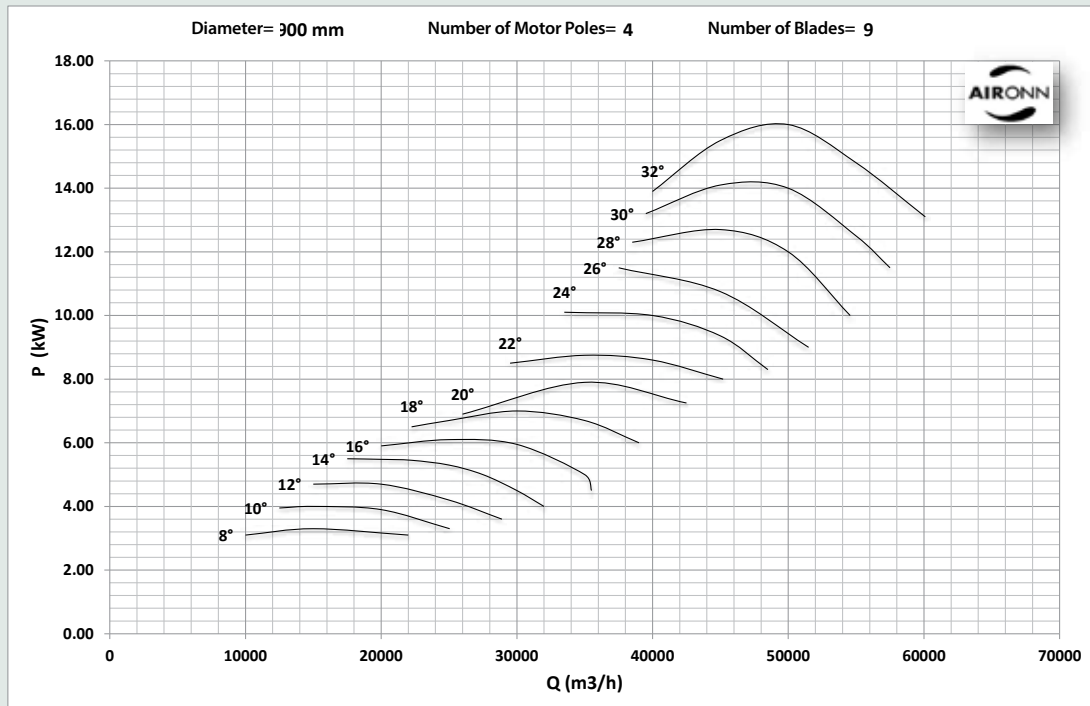
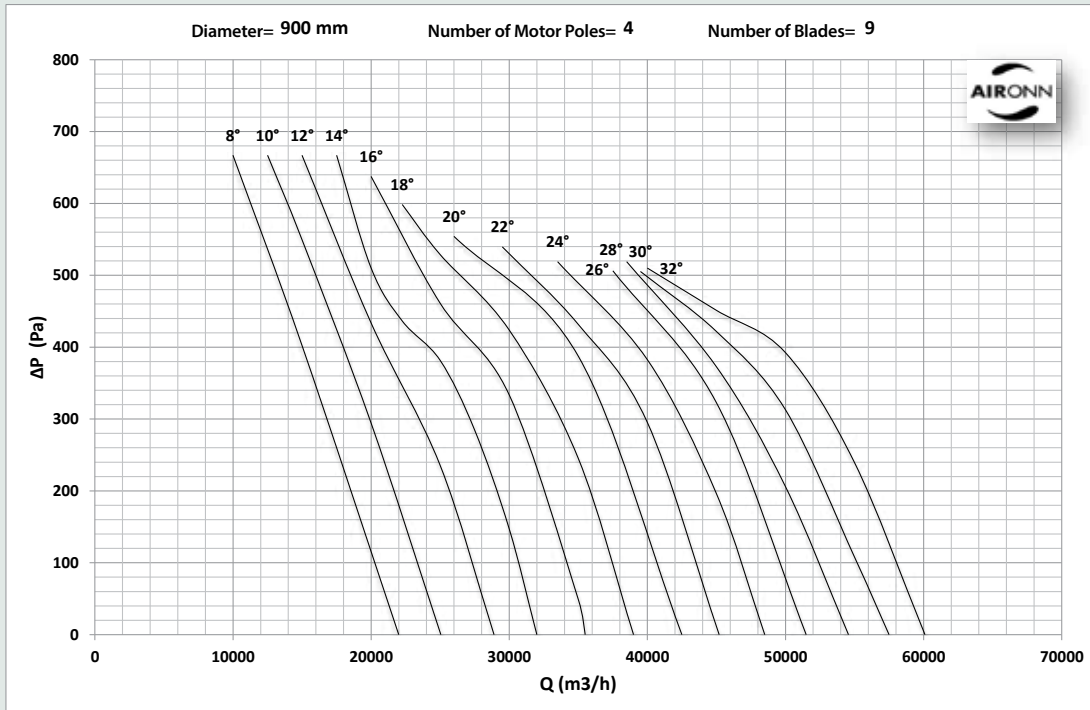

# Lobby Type Axial Smoke Exhaust Fan Series for Roofs

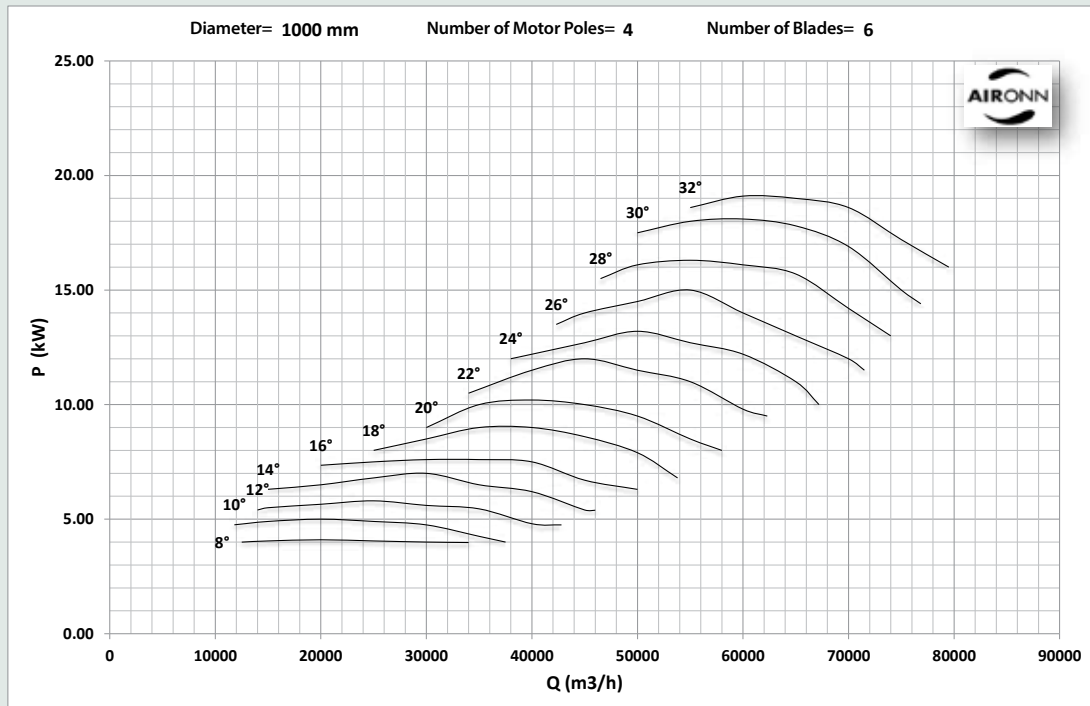
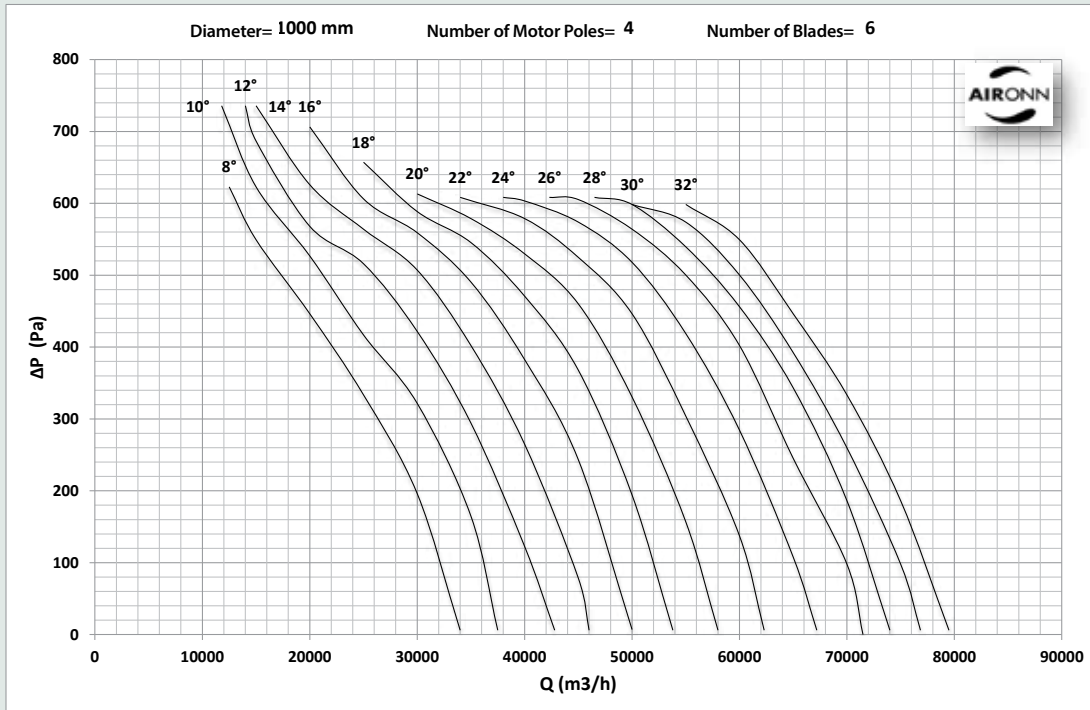

# Lobby Type Axial Smoke Exhaust Fan Series for Roofs

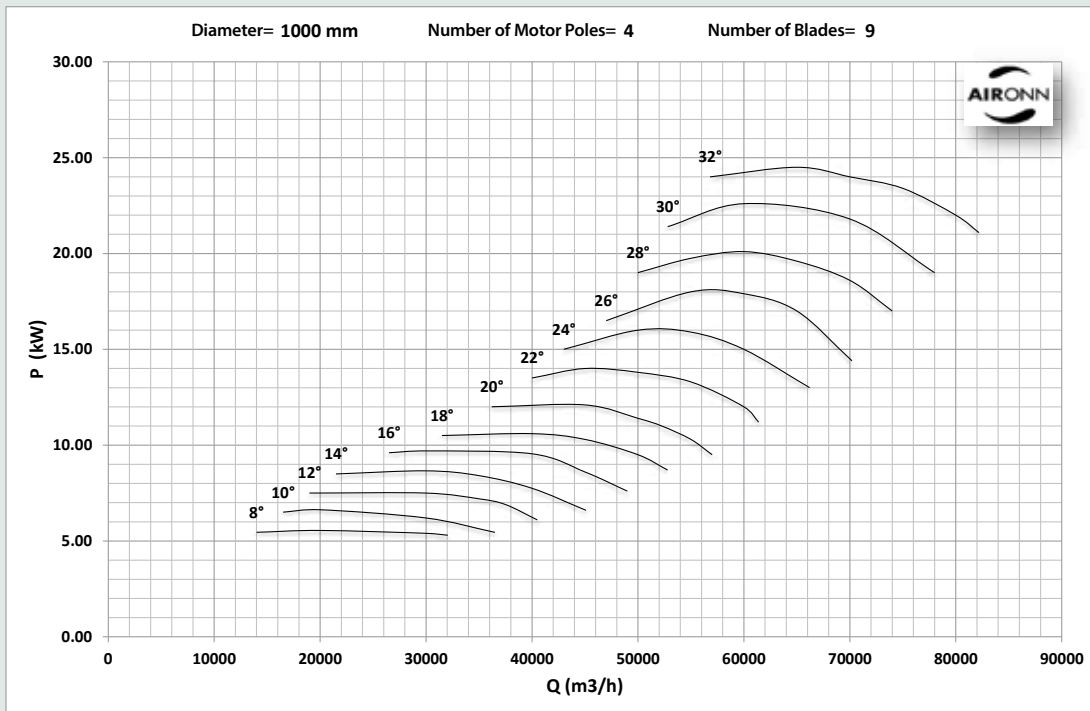
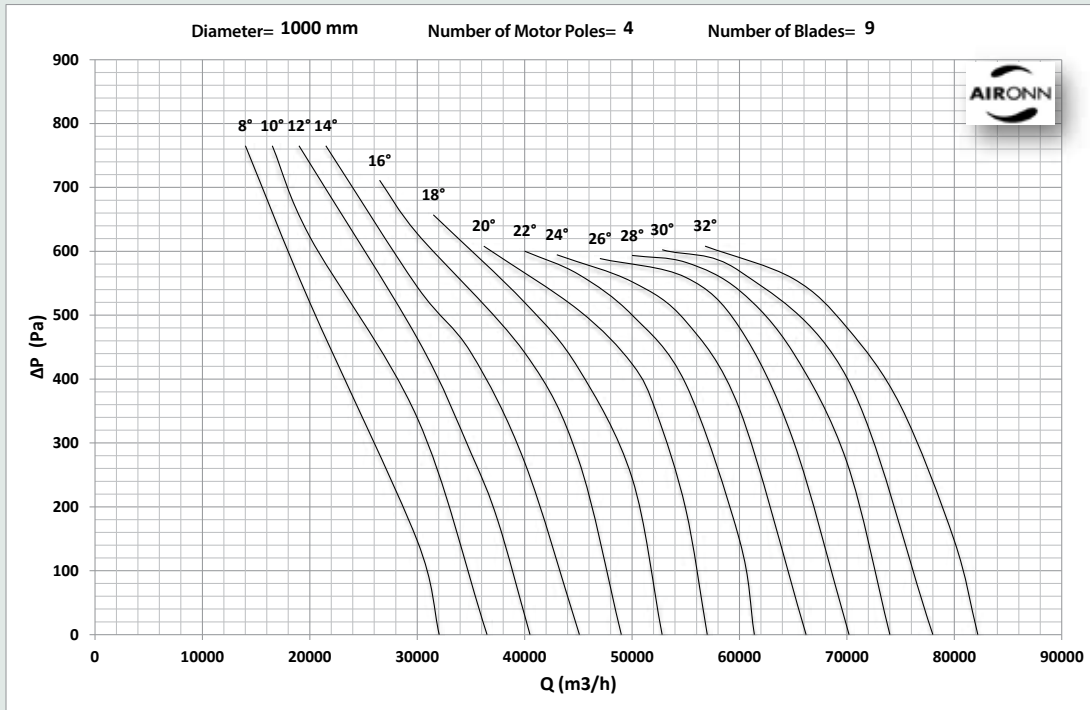

# Lobby Type Axial Smoke Exhaust Fan Series for Roofs

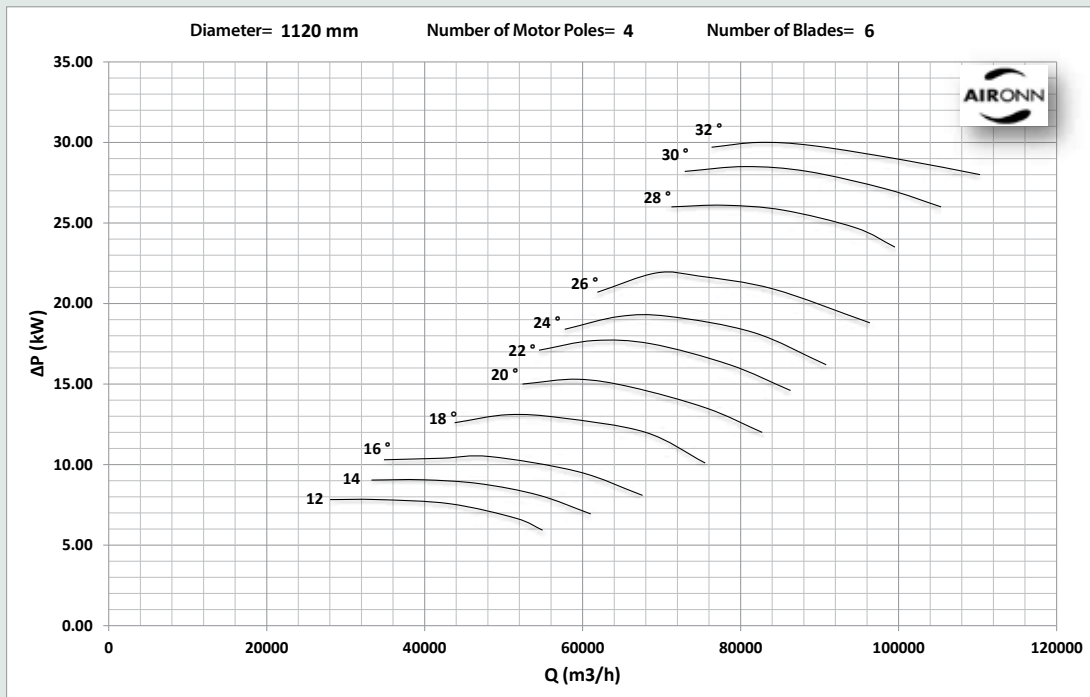
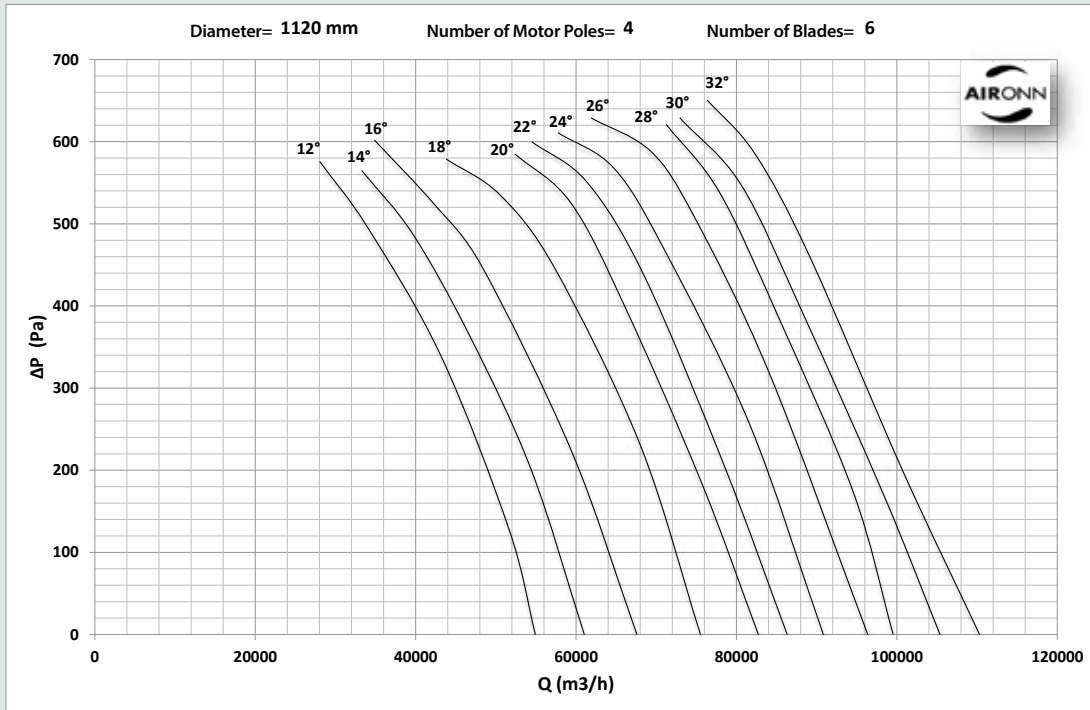

# Lobby Type Axial Smoke Exhaust Fan Series for Roofs

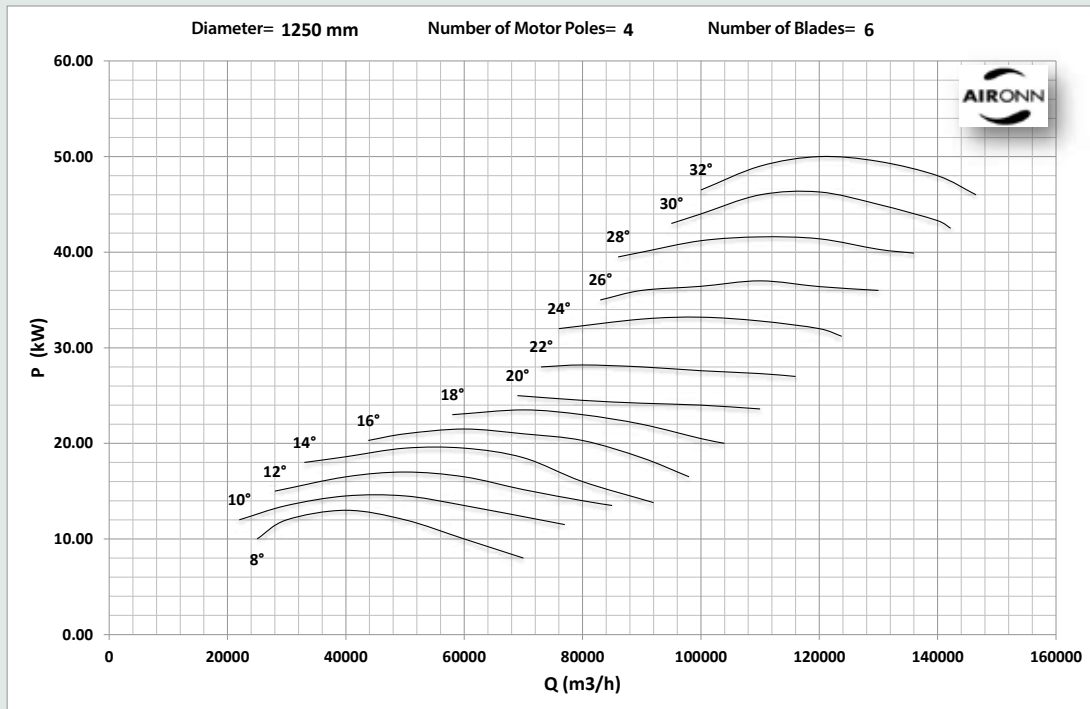
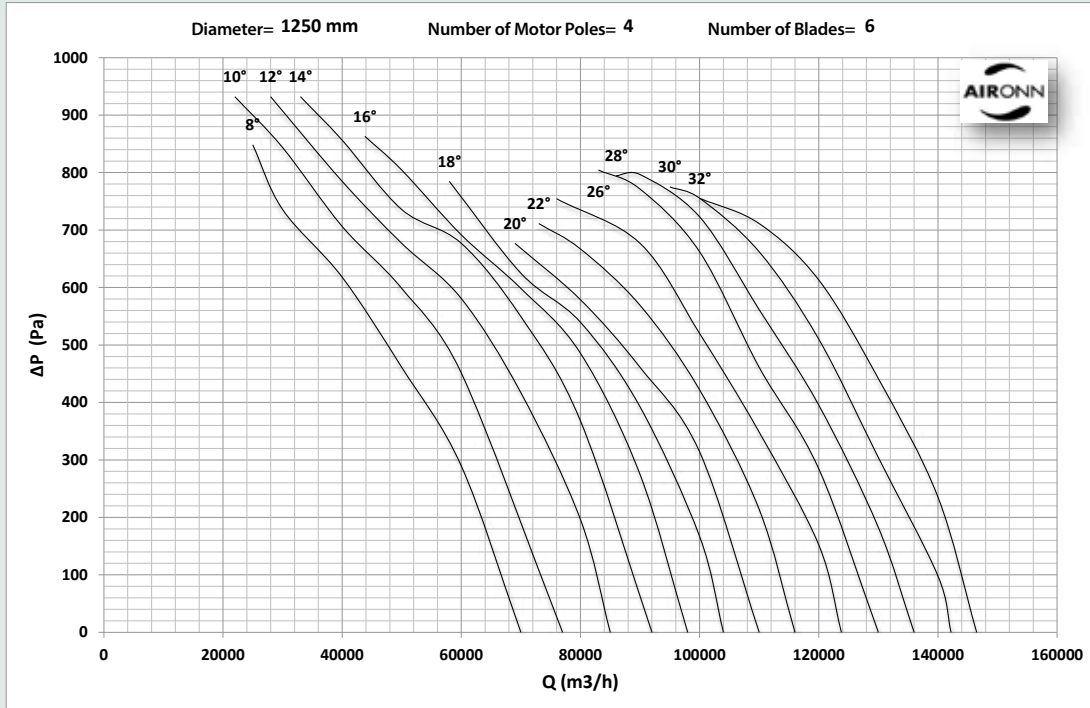

# Lobby Type Axial Smoke Exhaust Fan Series for Roofs

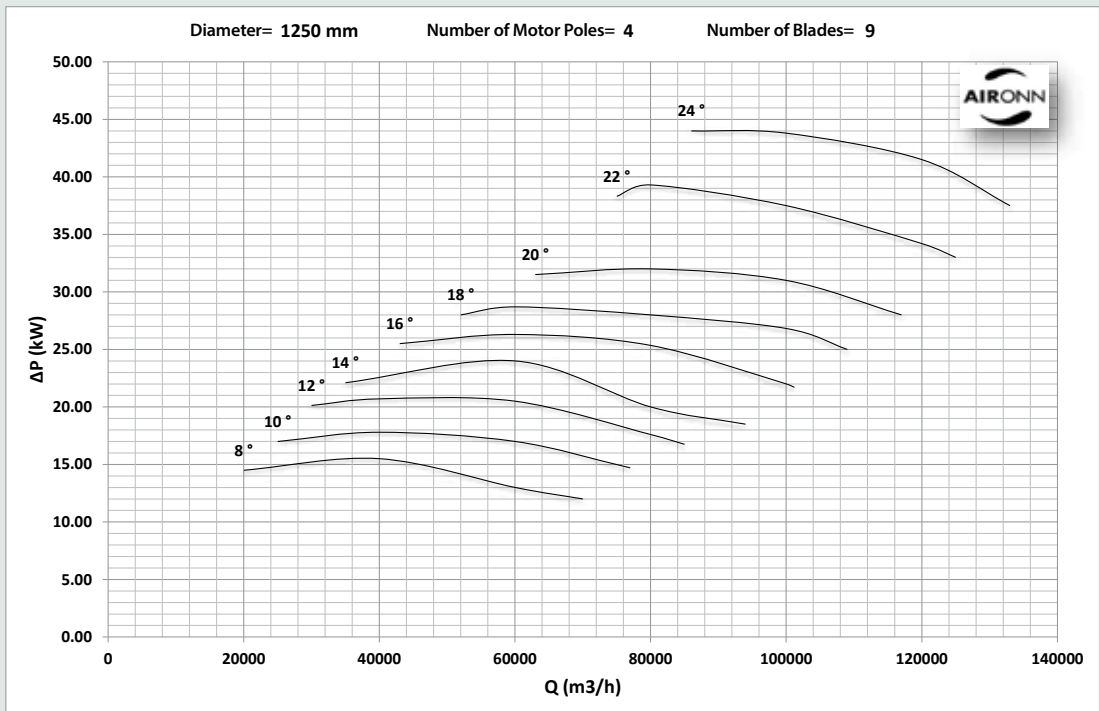
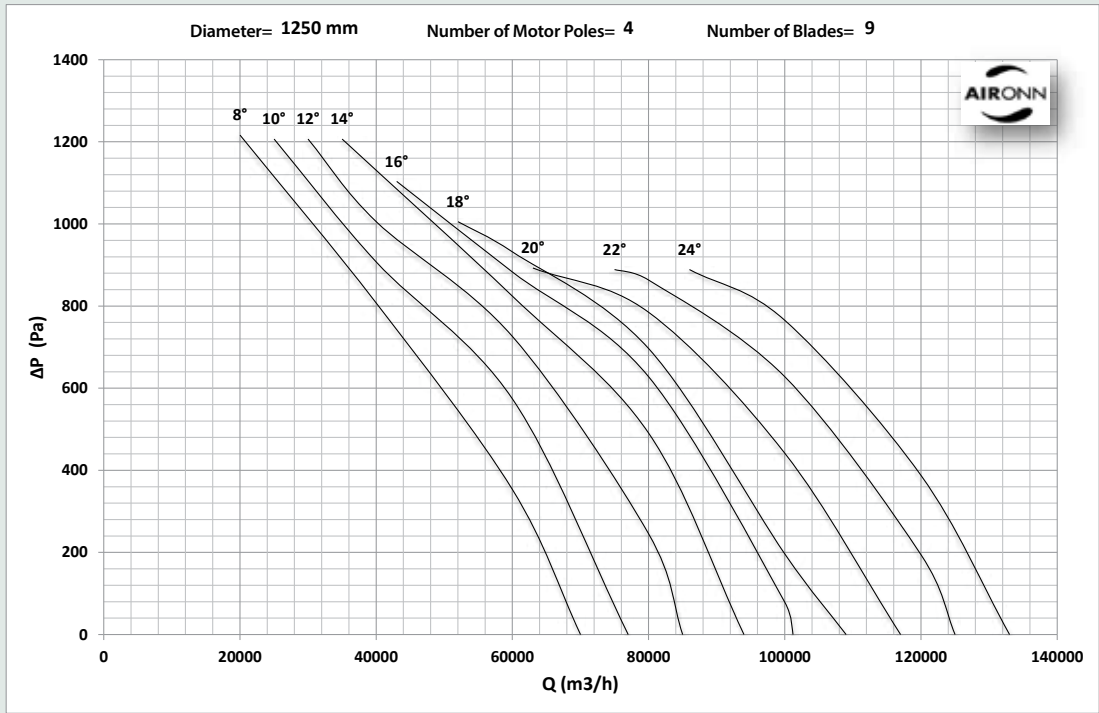



# Lobby Type Axial Smoke Exhaust Fan Series for Roofs

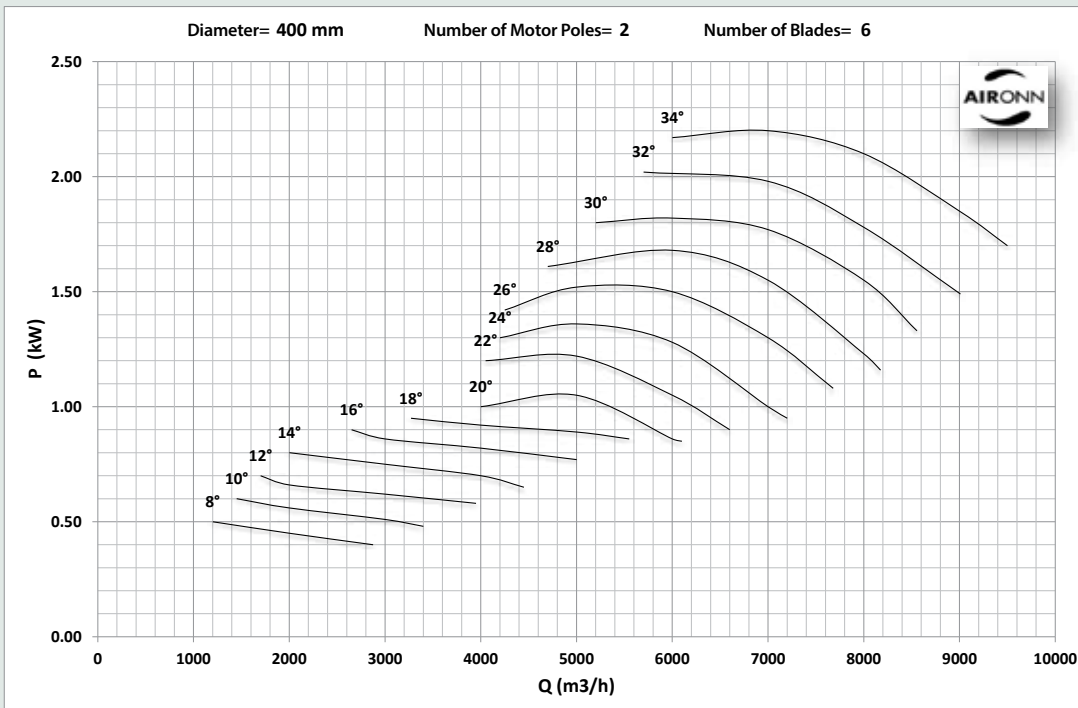
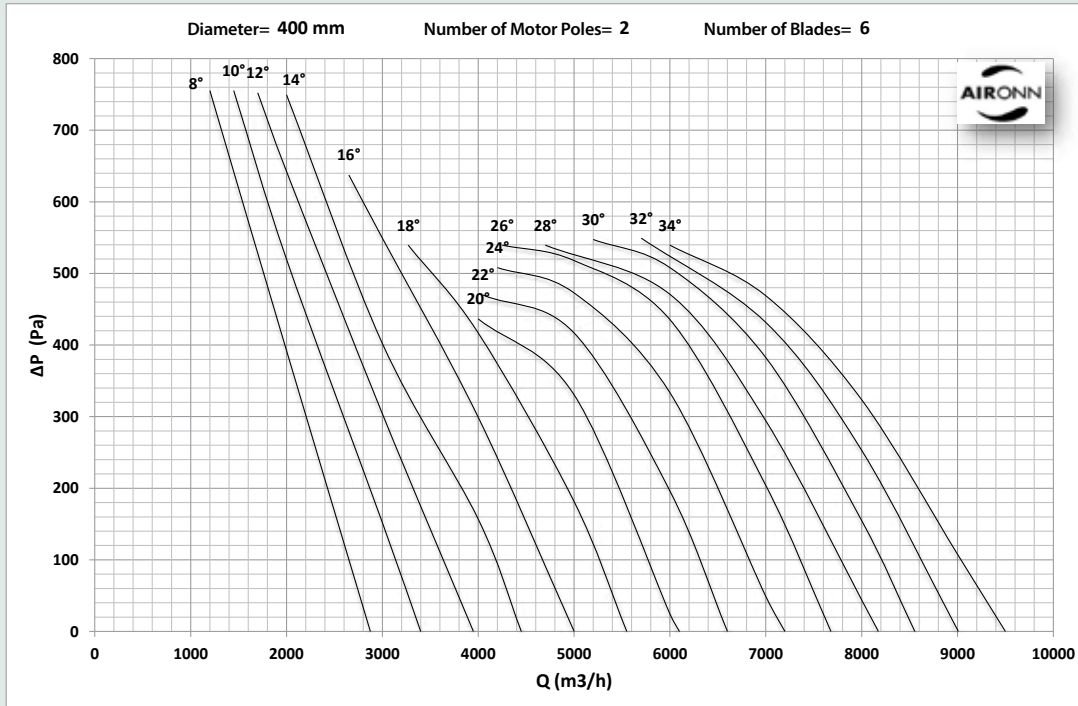

# Lobby Type Axial Smoke Exhaust Fan Series for Roofs

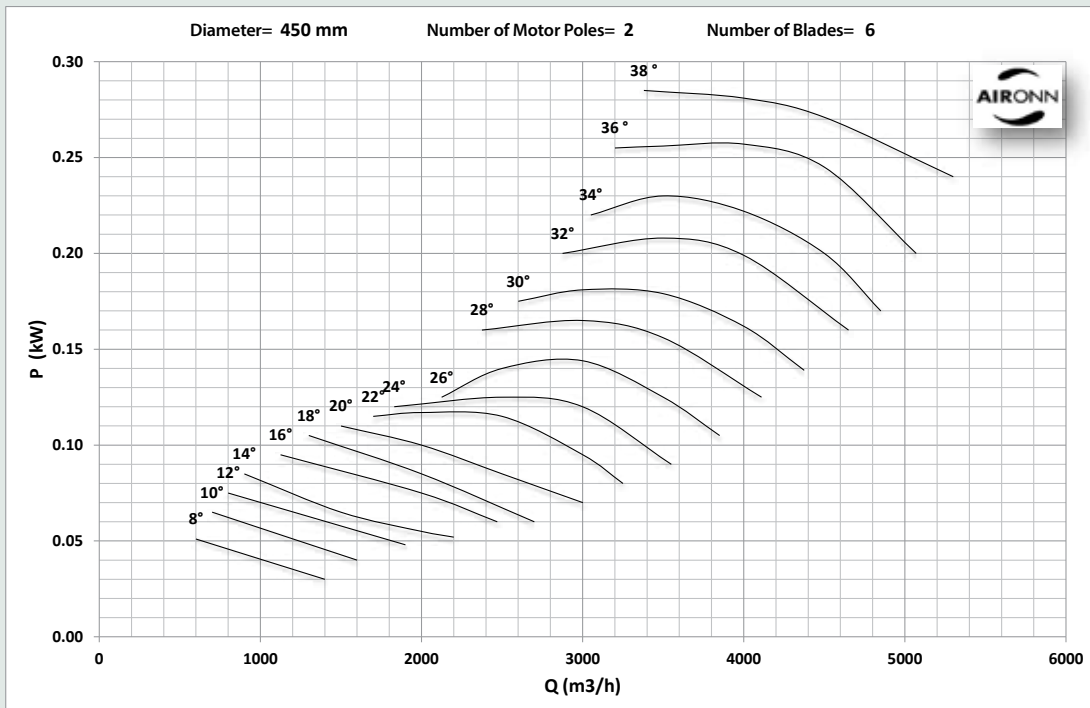
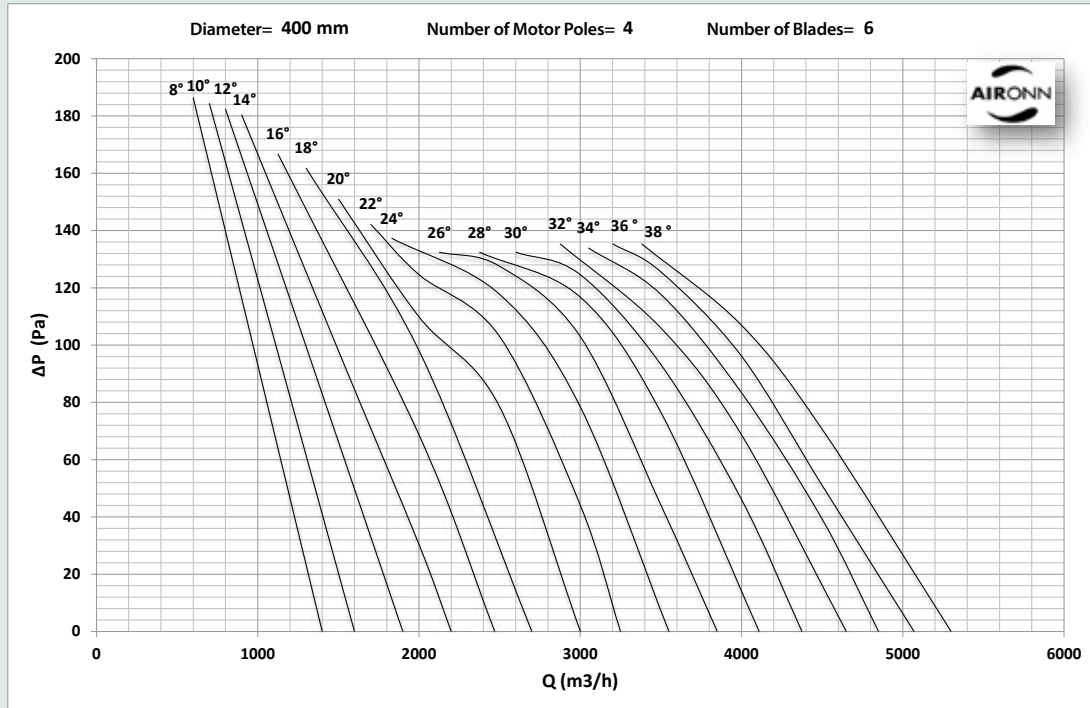

# Lobby Type Axial Smoke Exhaust Fan Series for Roofs

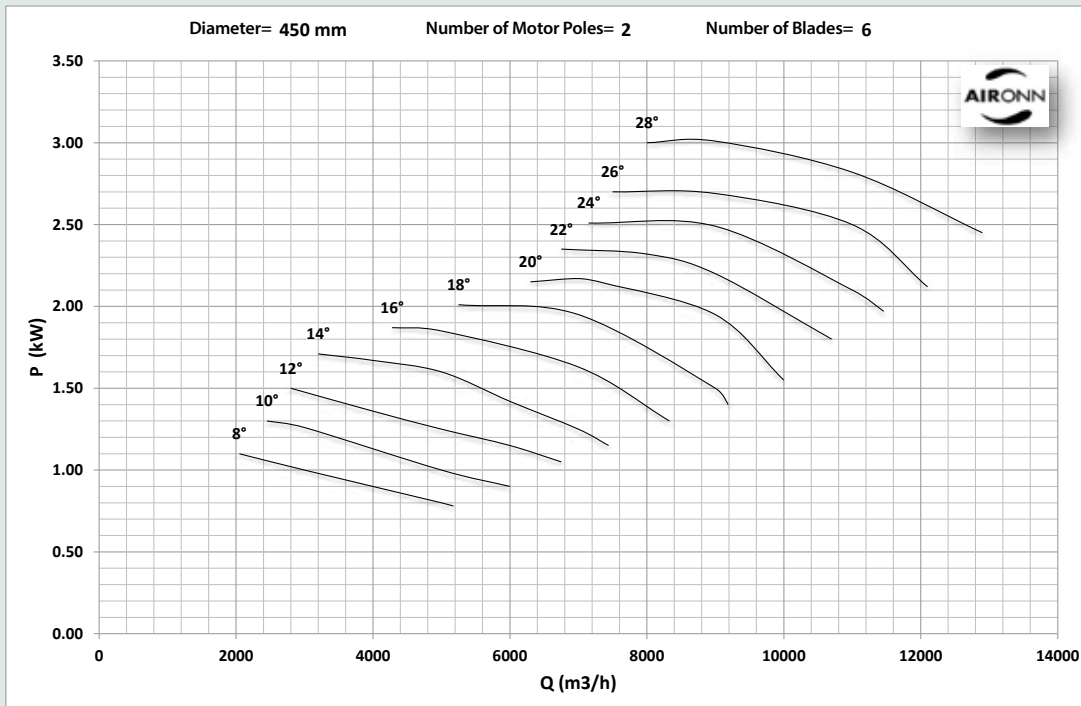
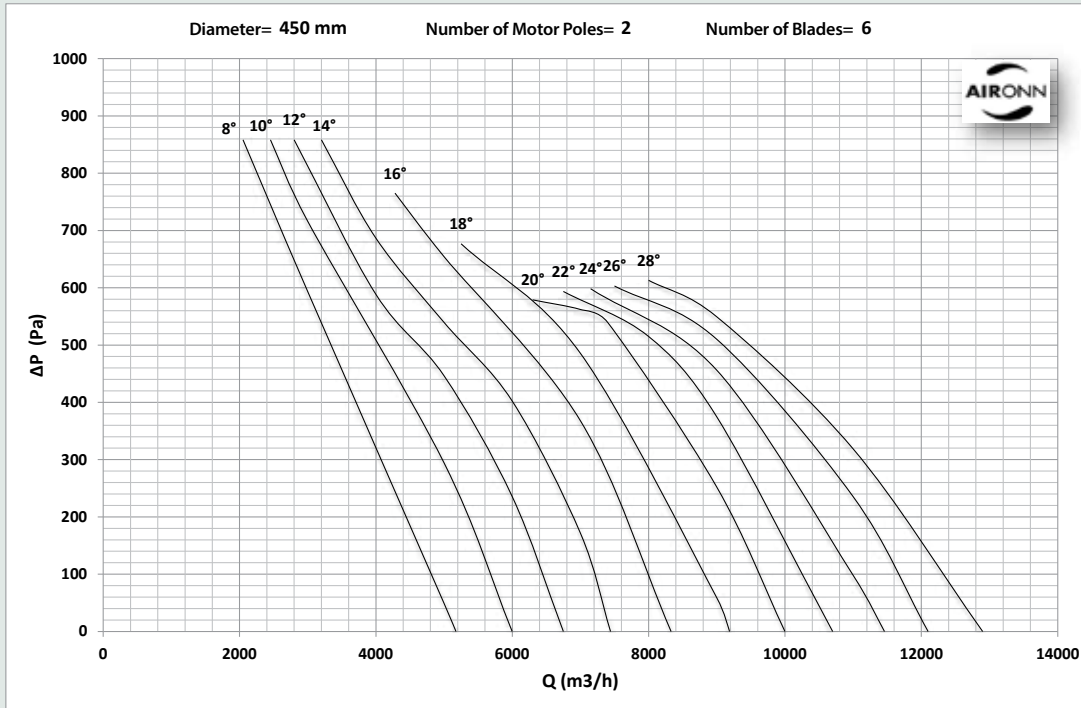

# Lobby Type Axial Smoke Exhaust Fan Series for Roofs

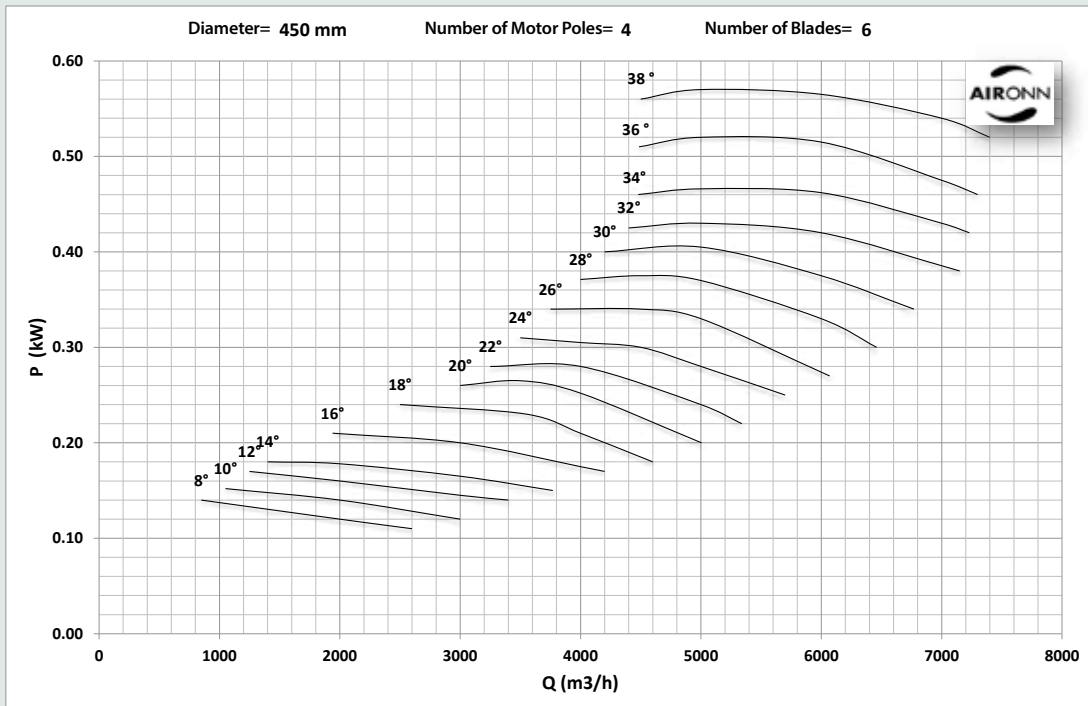
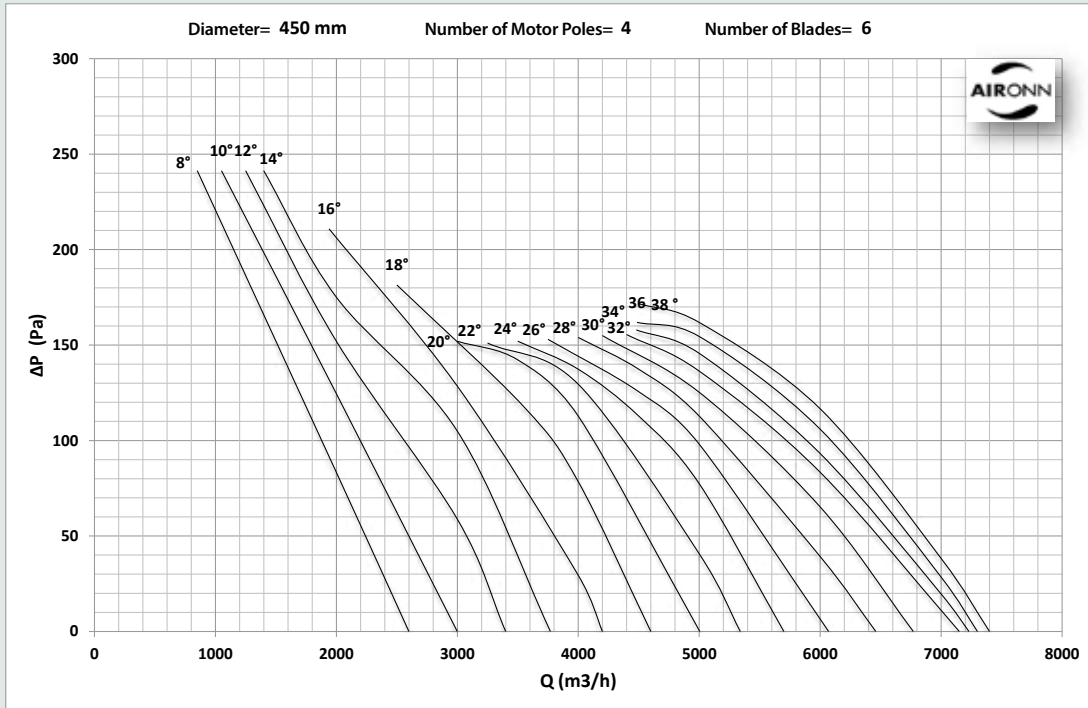

# Lobby Type Axial Smoke Exhaust Fan Series for Roofs

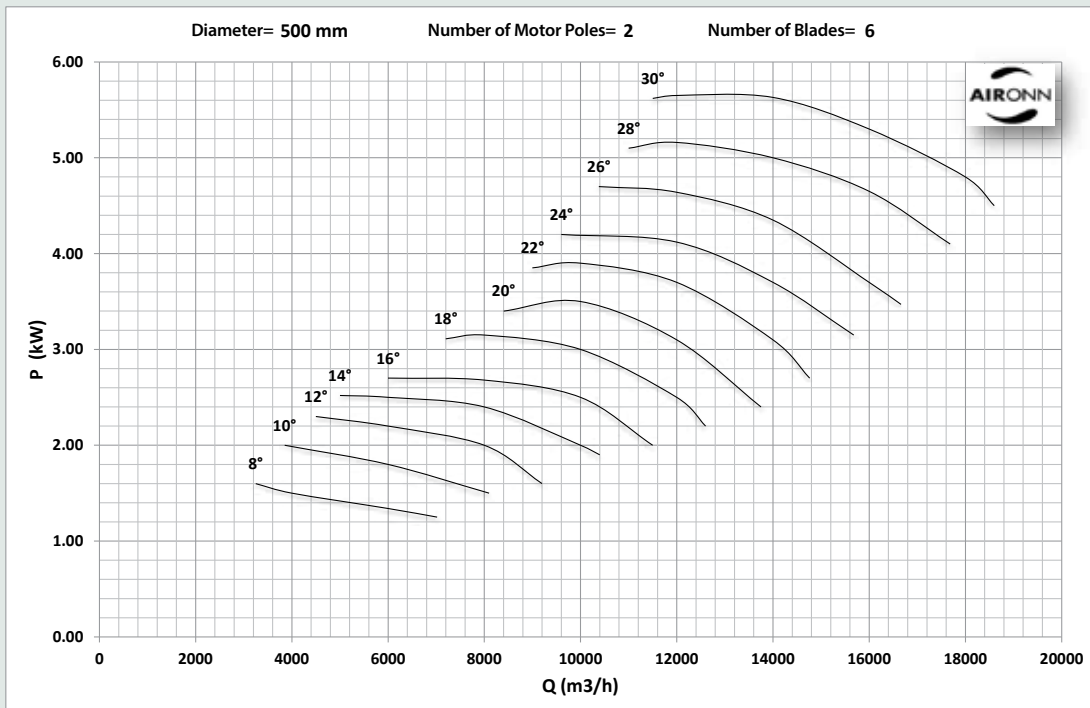
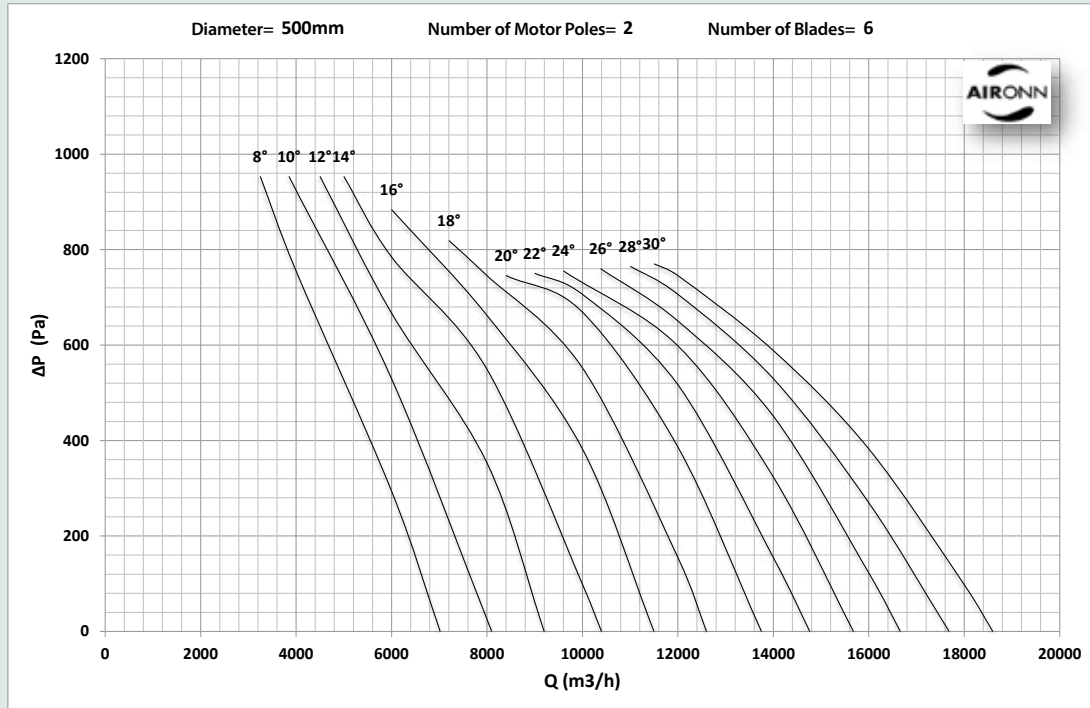

# Lobby Type Axial Smoke Exhaust Fan Series for Roofs

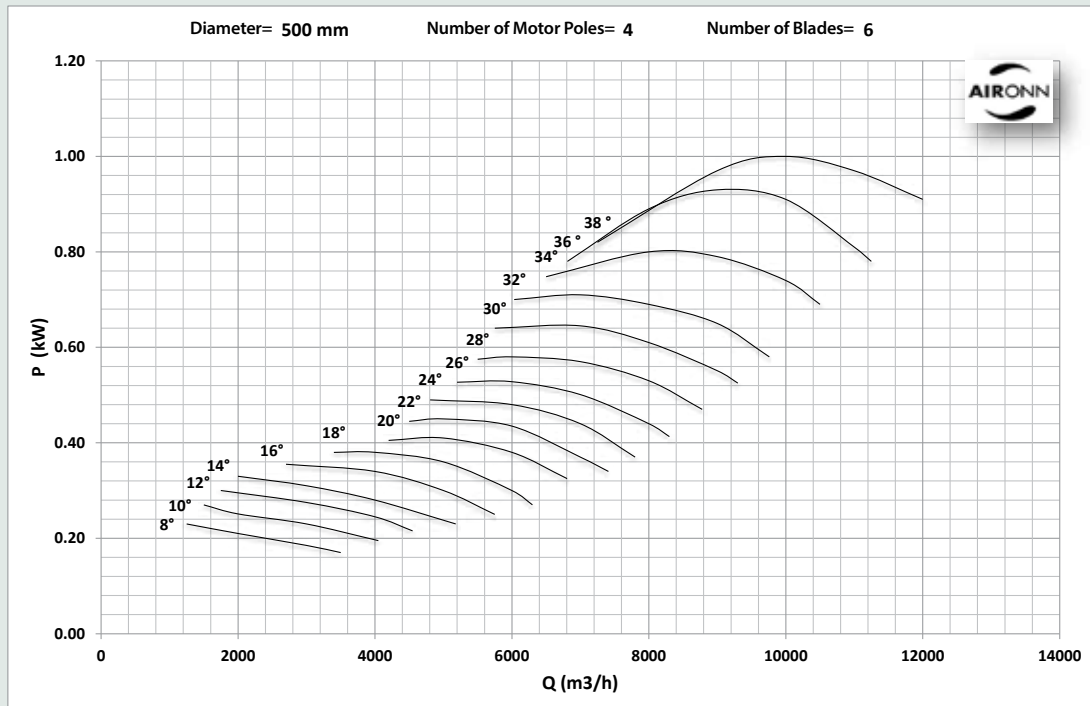
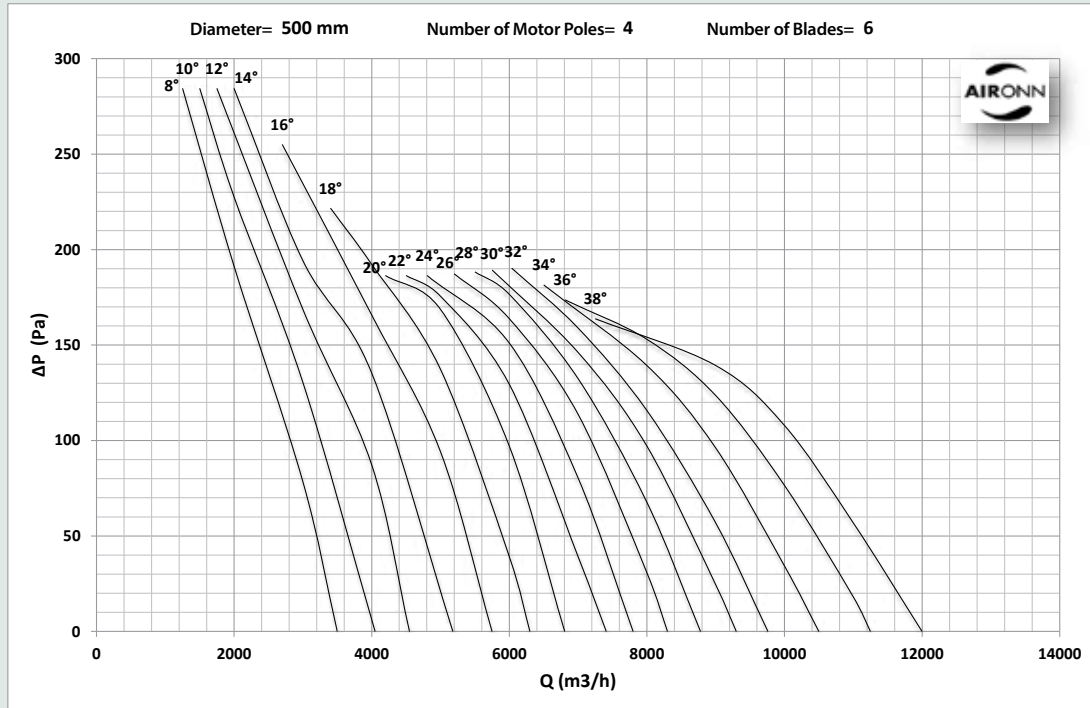

# Lobby Type Axial Smoke Exhaust Fan Series for Roofs

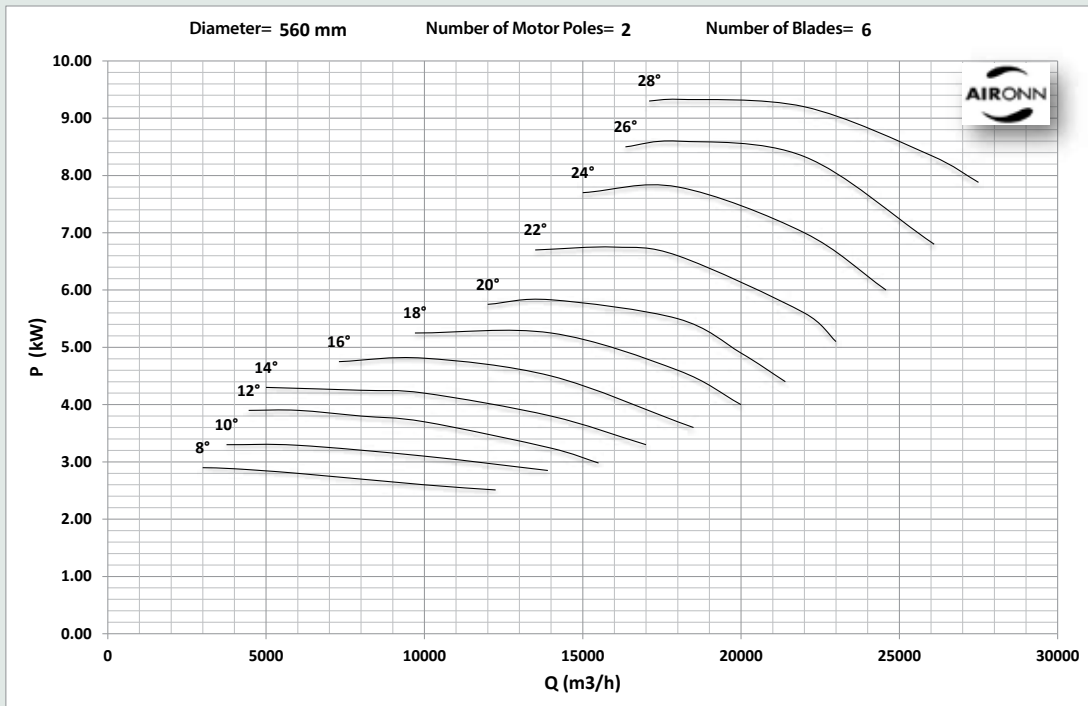
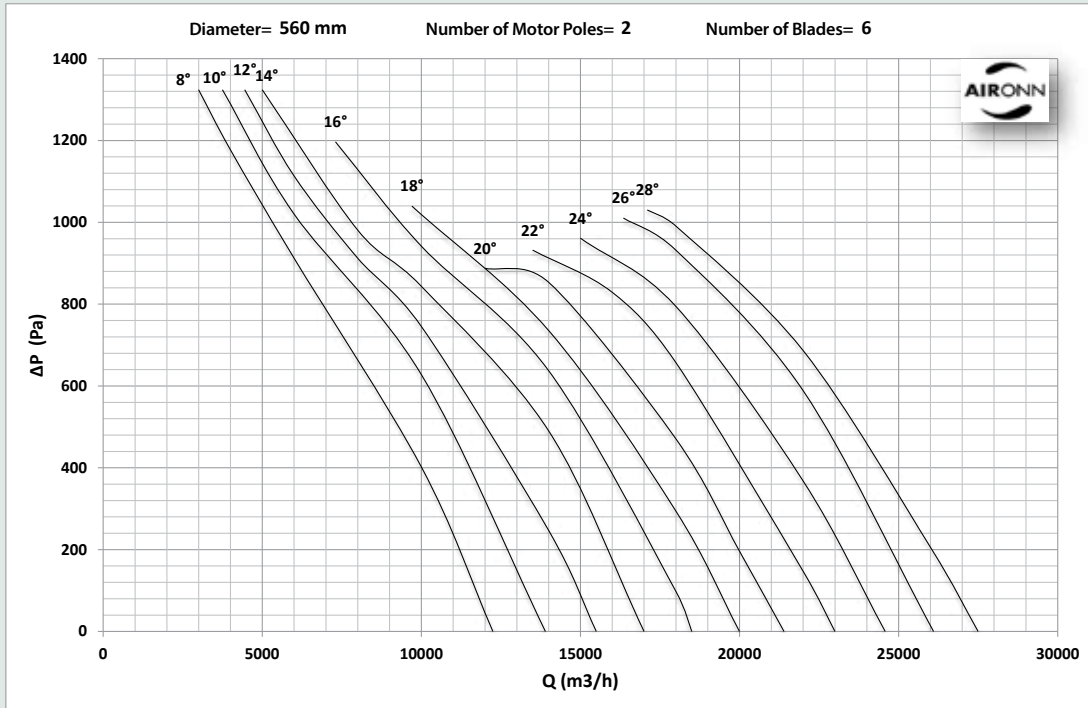

# Lobby Type Axial Smoke Exhaust Fan Series for Roofs

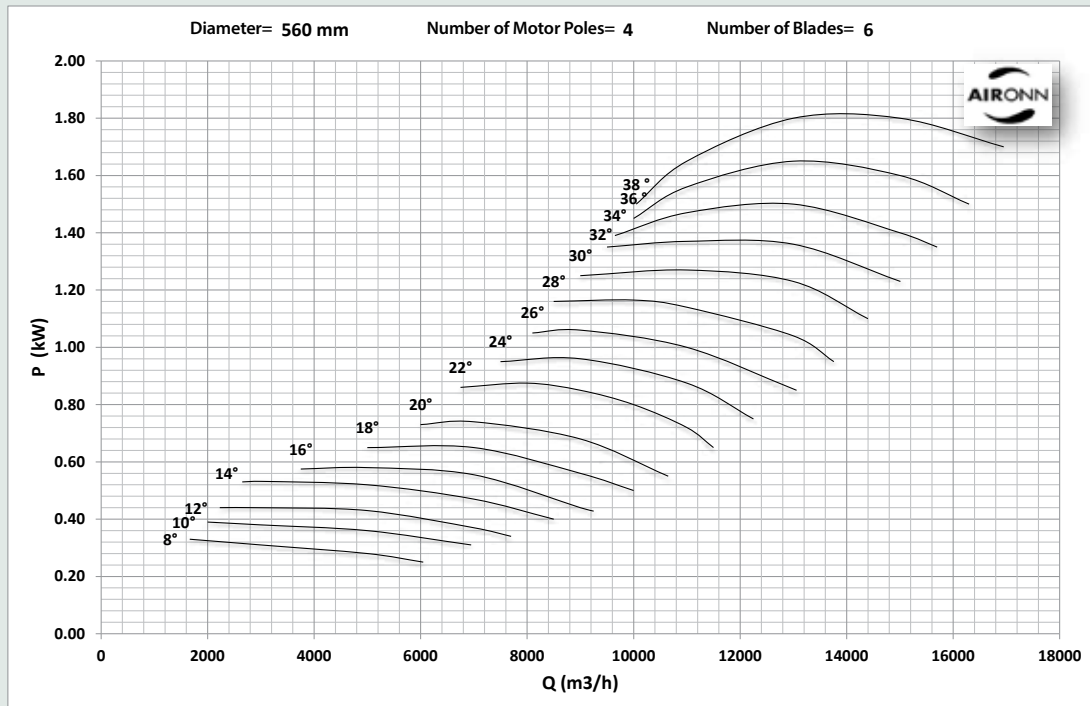
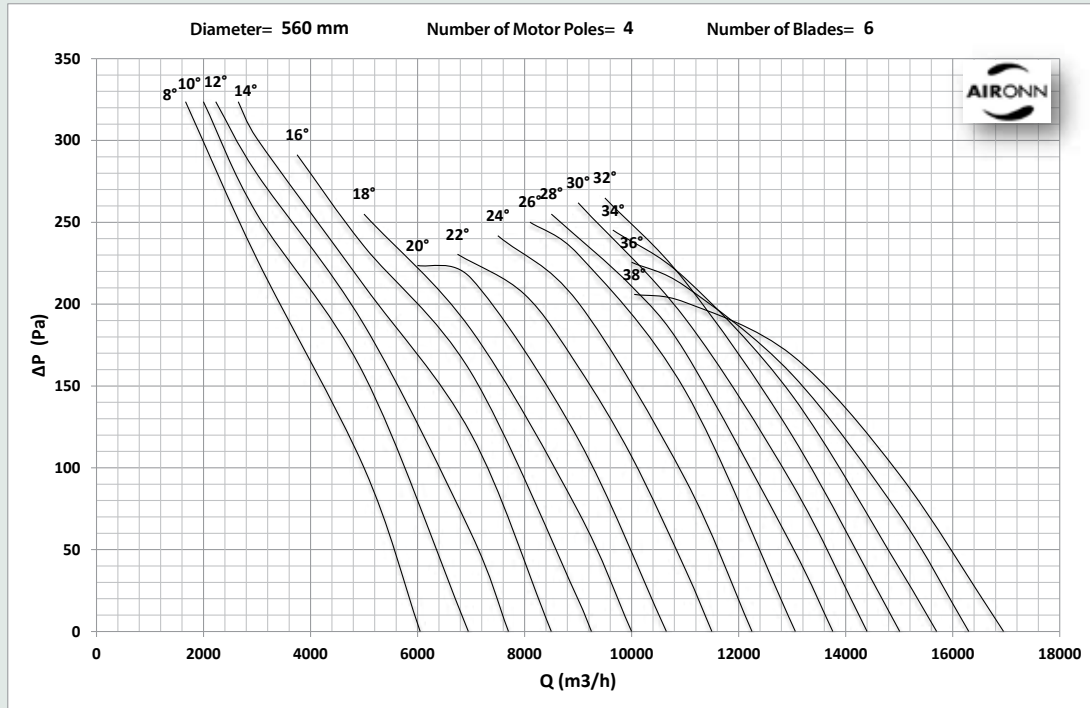



# Lobby Type Axial Smoke Exhaust Fan Series for Roofs

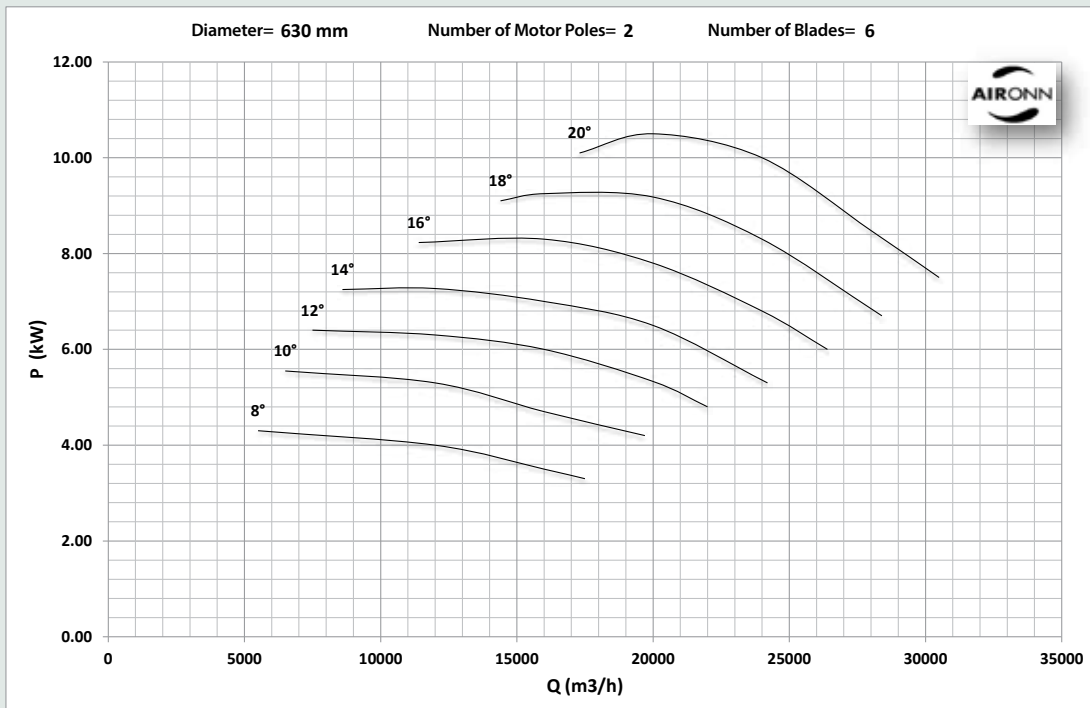
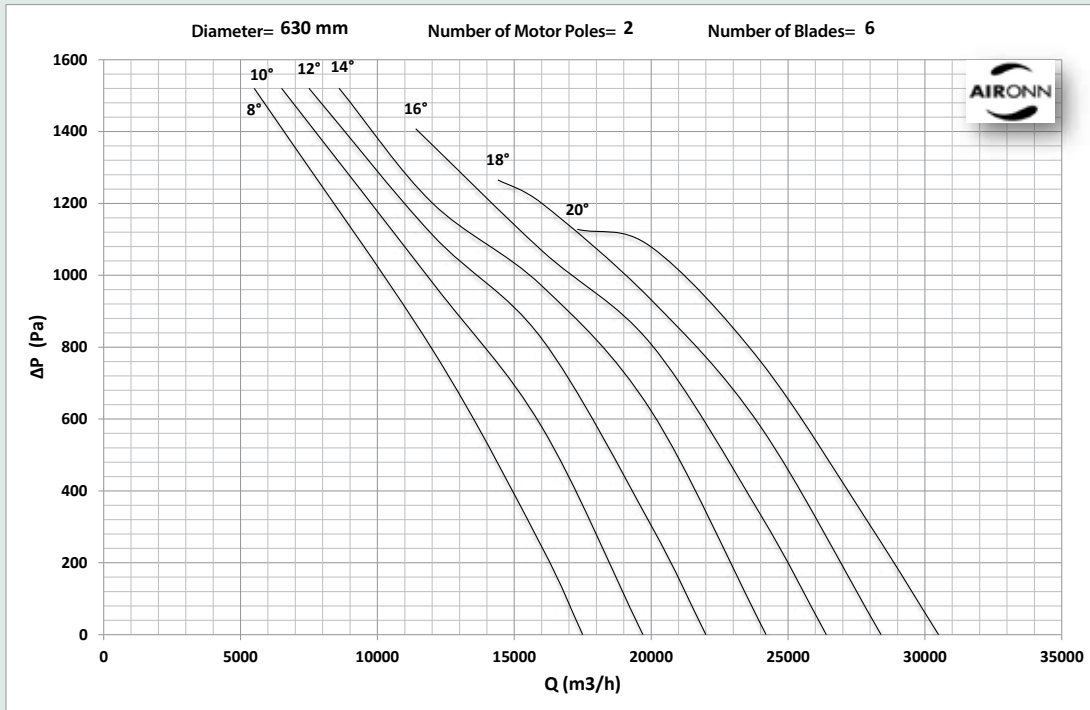

# Lobby Type Axial Smoke Exhaust Fan Series for Roofs

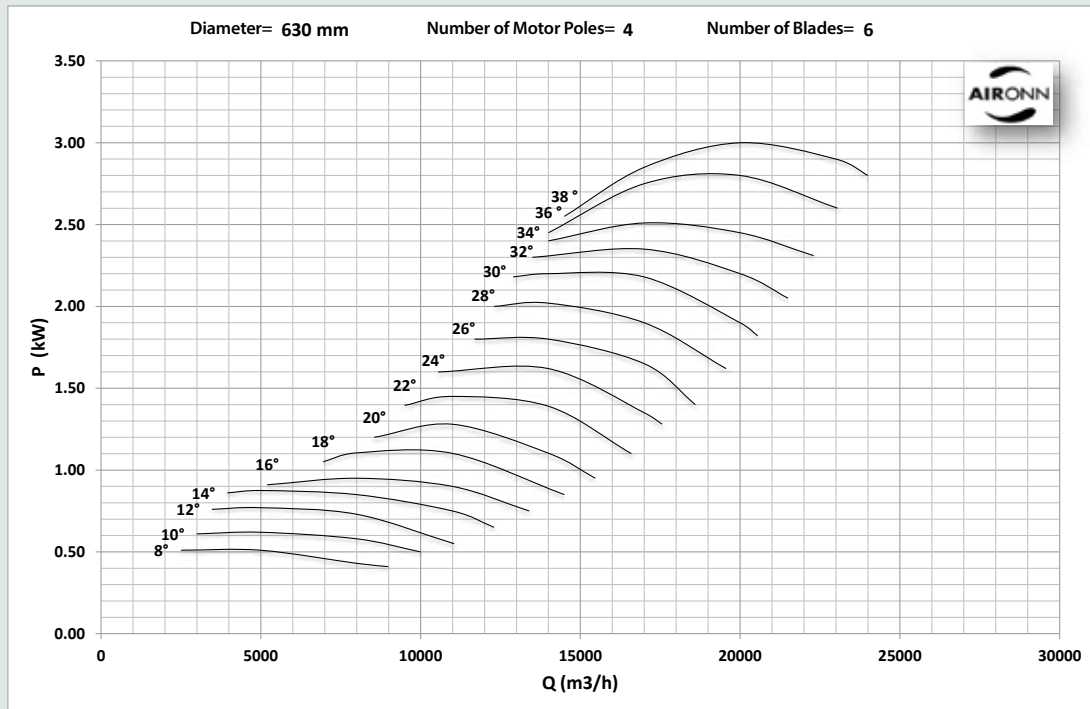
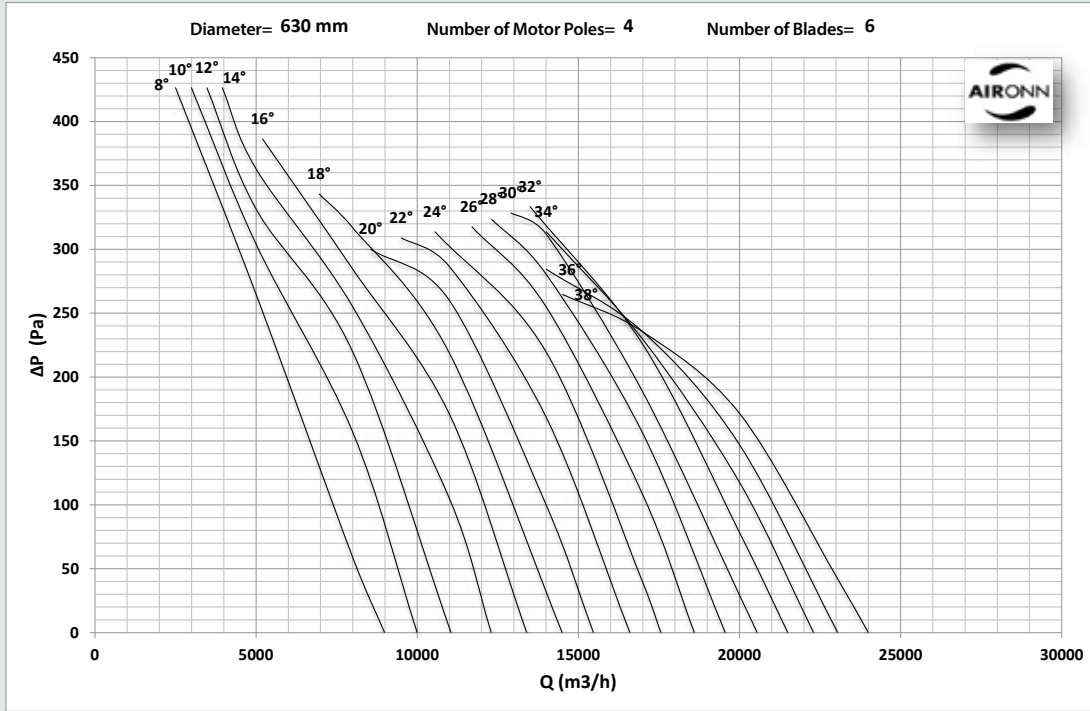

# Lobby Type Axial Smoke Exhaust Fan Series for Roofs

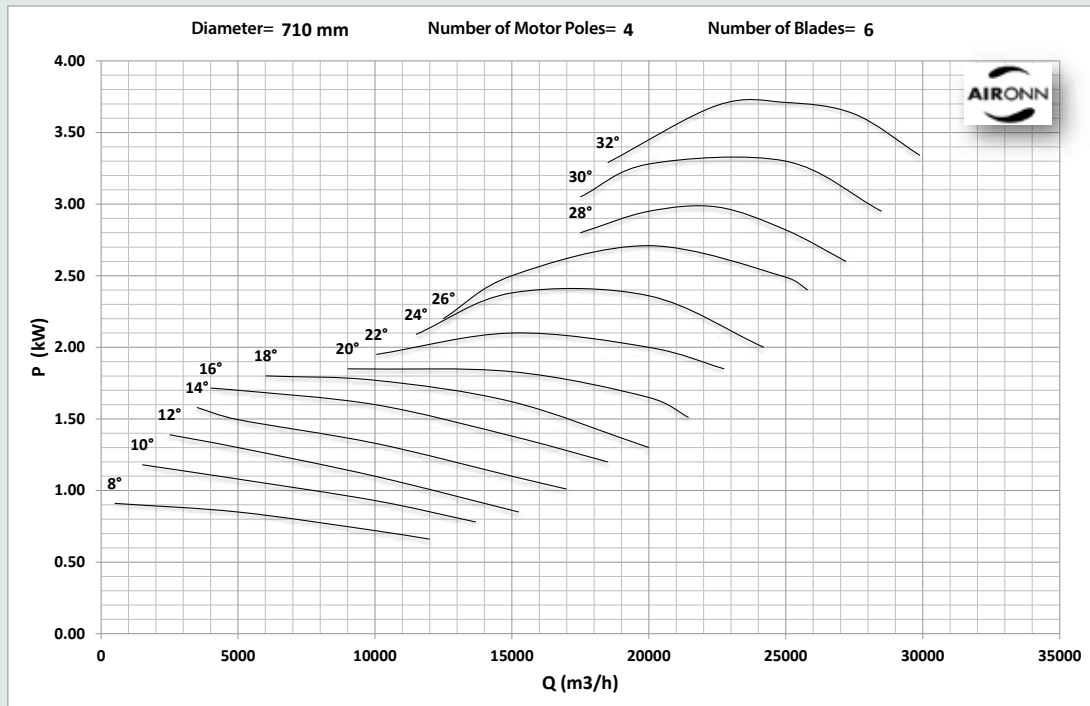
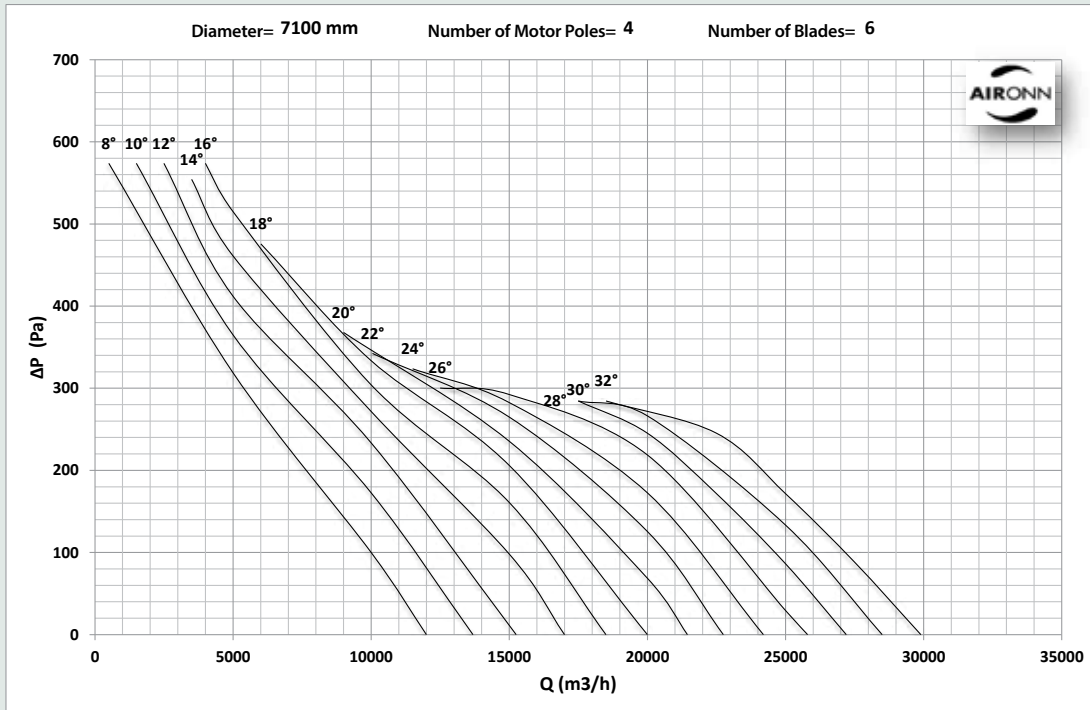

# Lobby Type Axial Smoke Exhaust Fan Series for Roofs

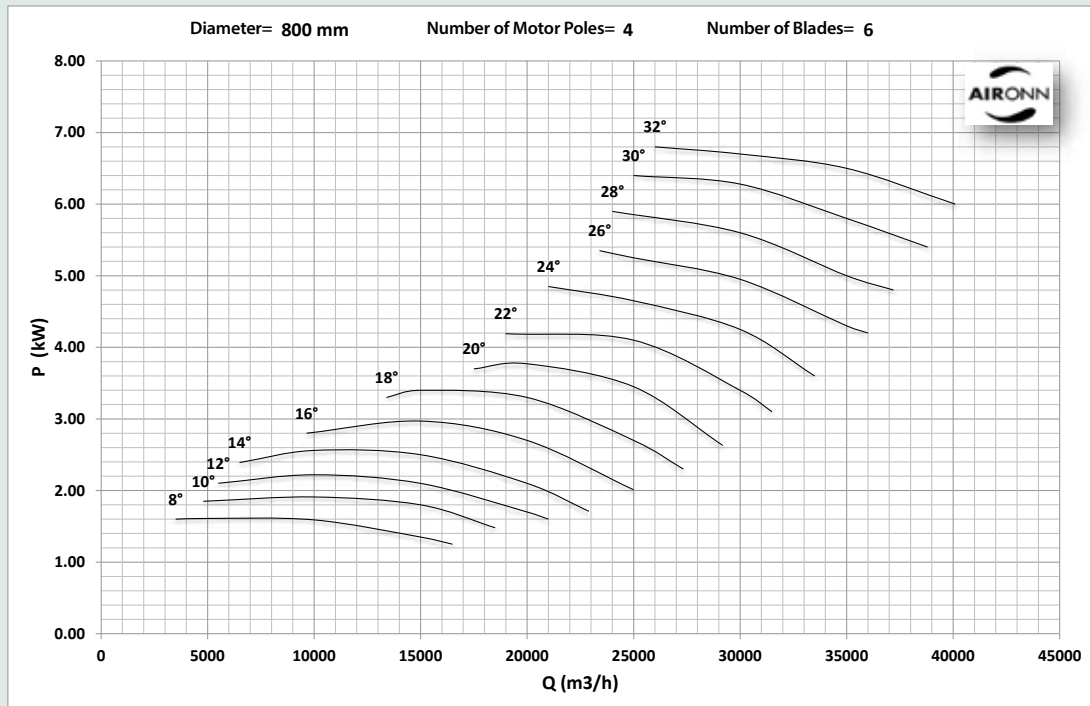
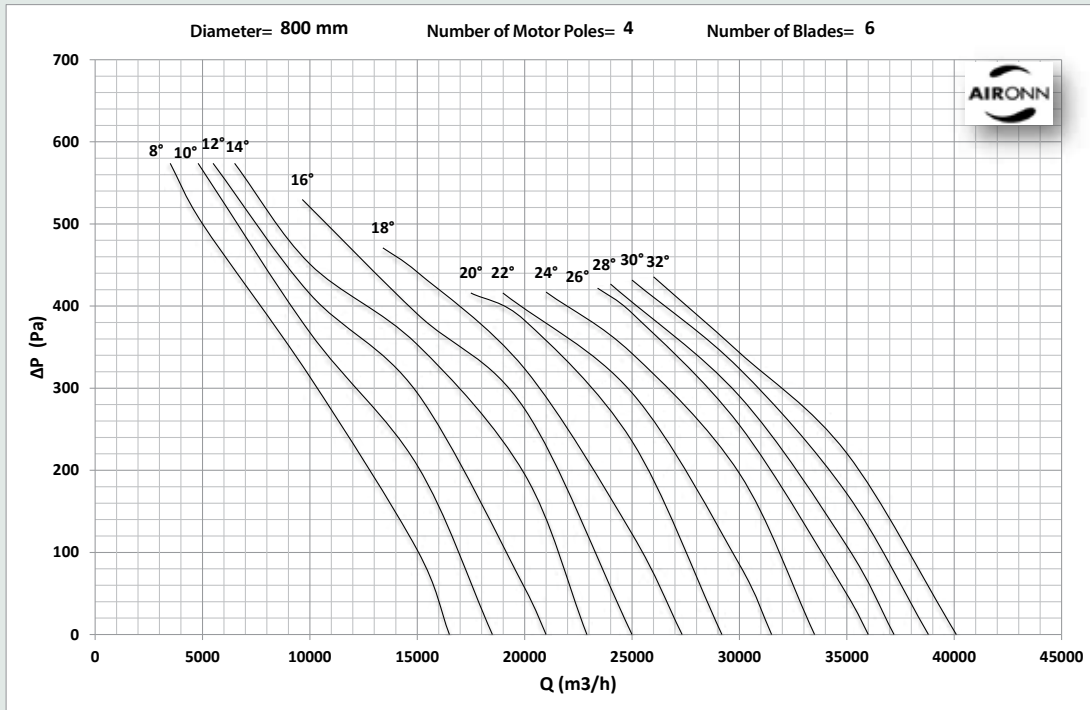

# Lobby Type Axial Smoke Exhaust Fan Series for Roofs

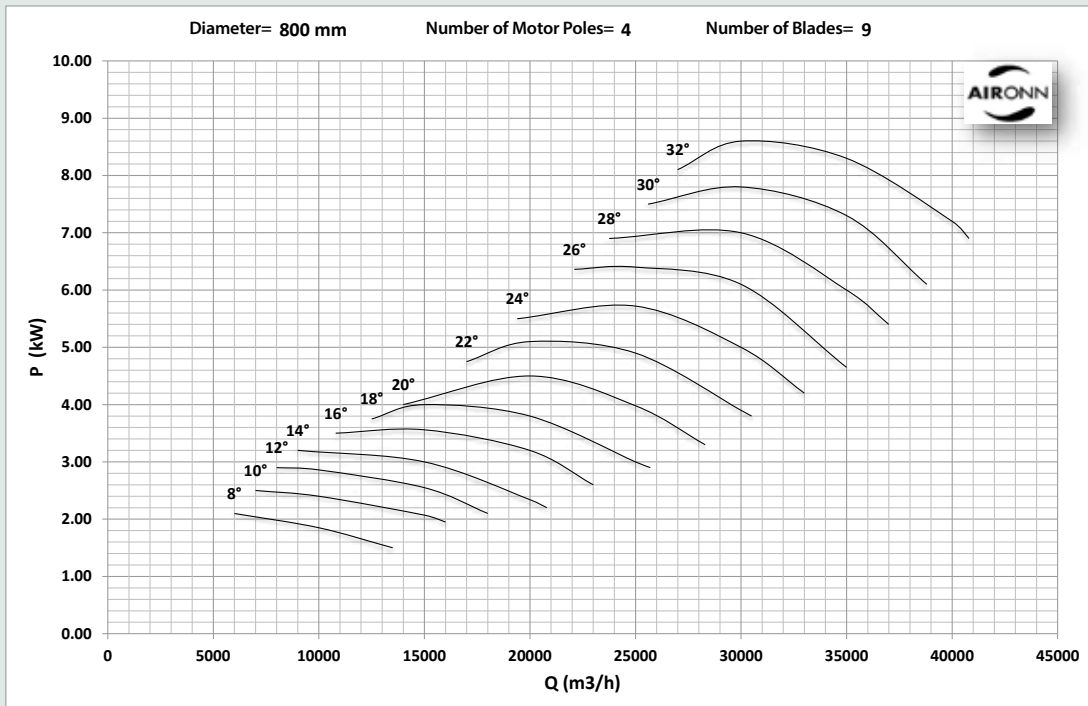
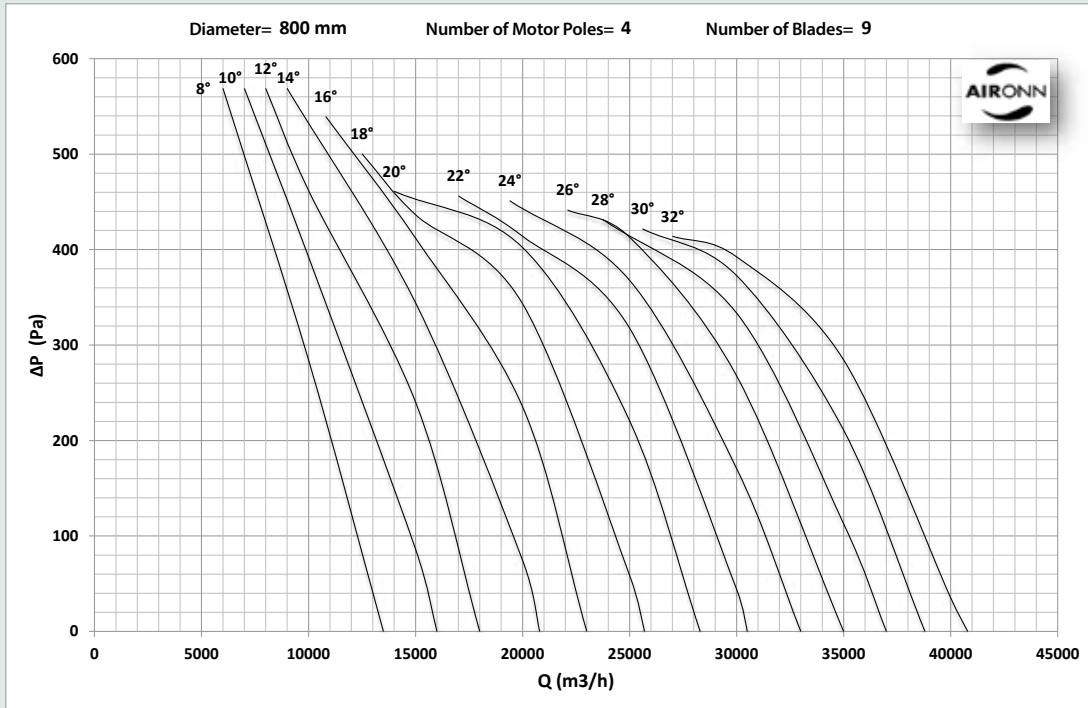

# Lobby Type Axial Smoke Exhaust Fan Series for Roofs

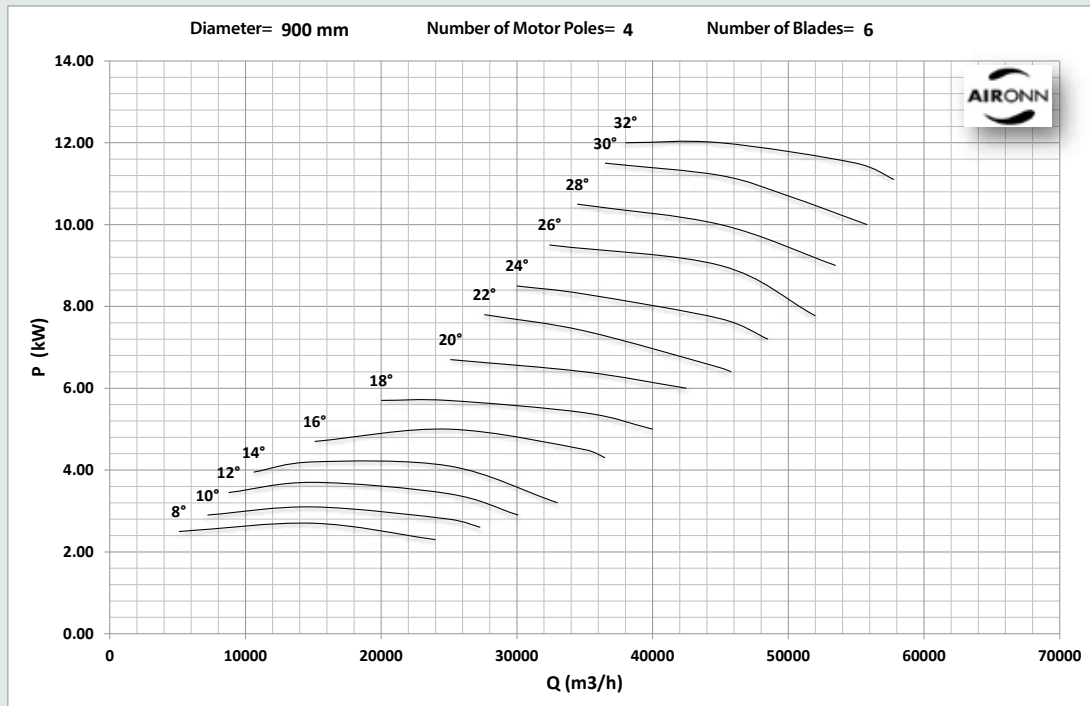
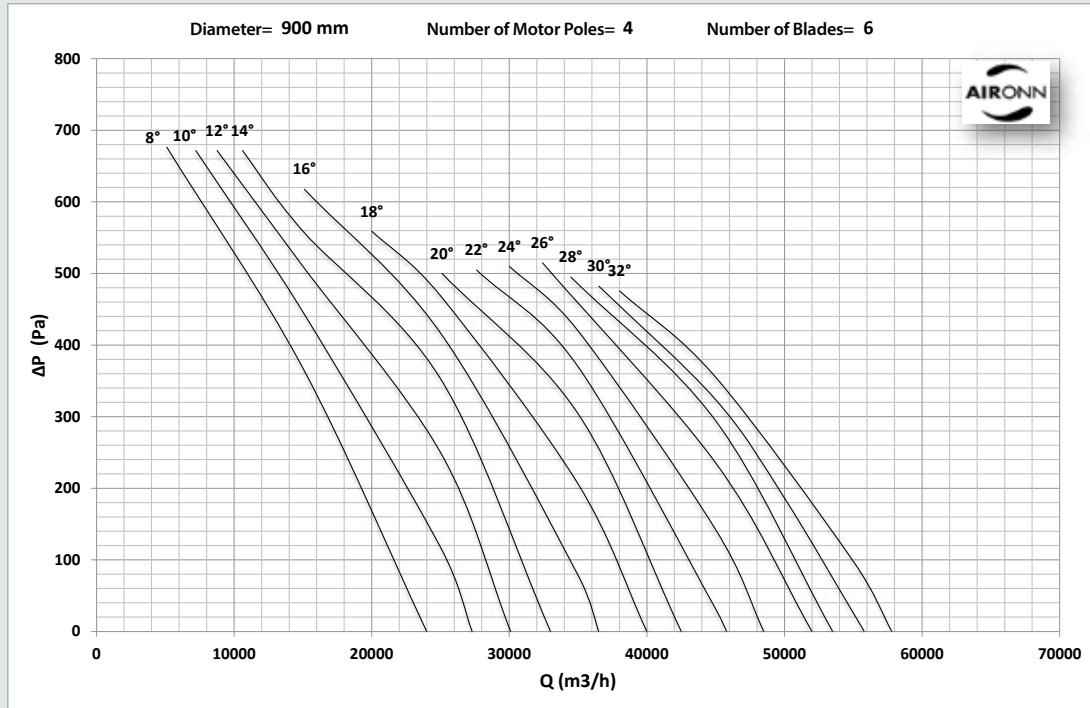

# Lobby Type Axial Smoke Exhaust Fan Series for Roofs

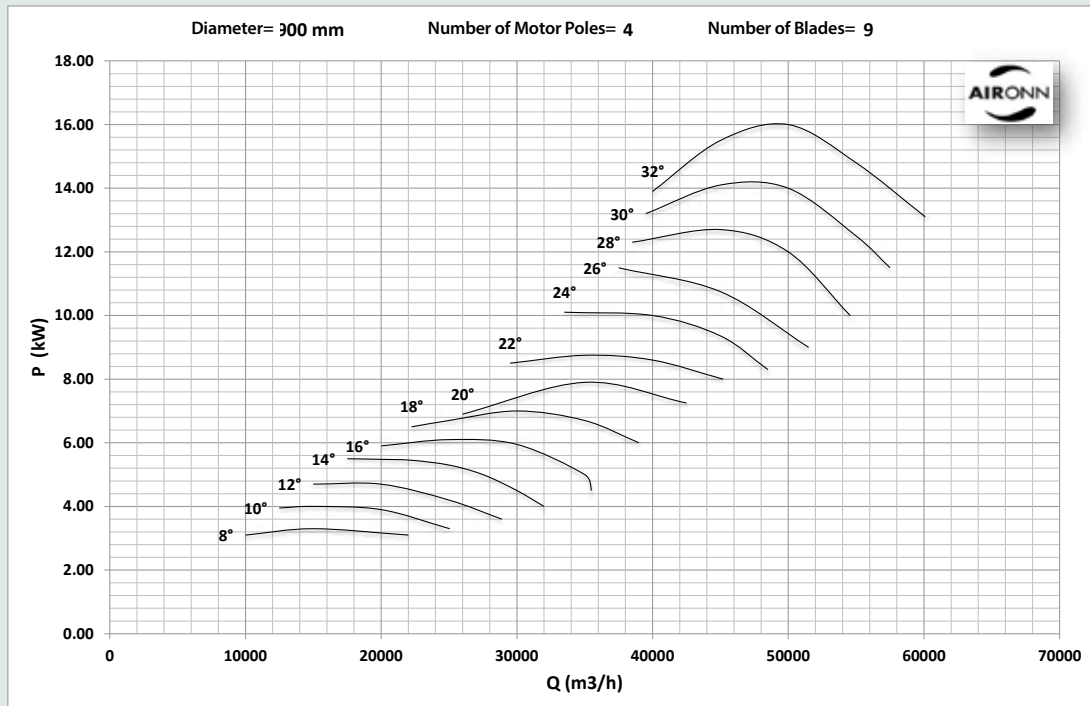
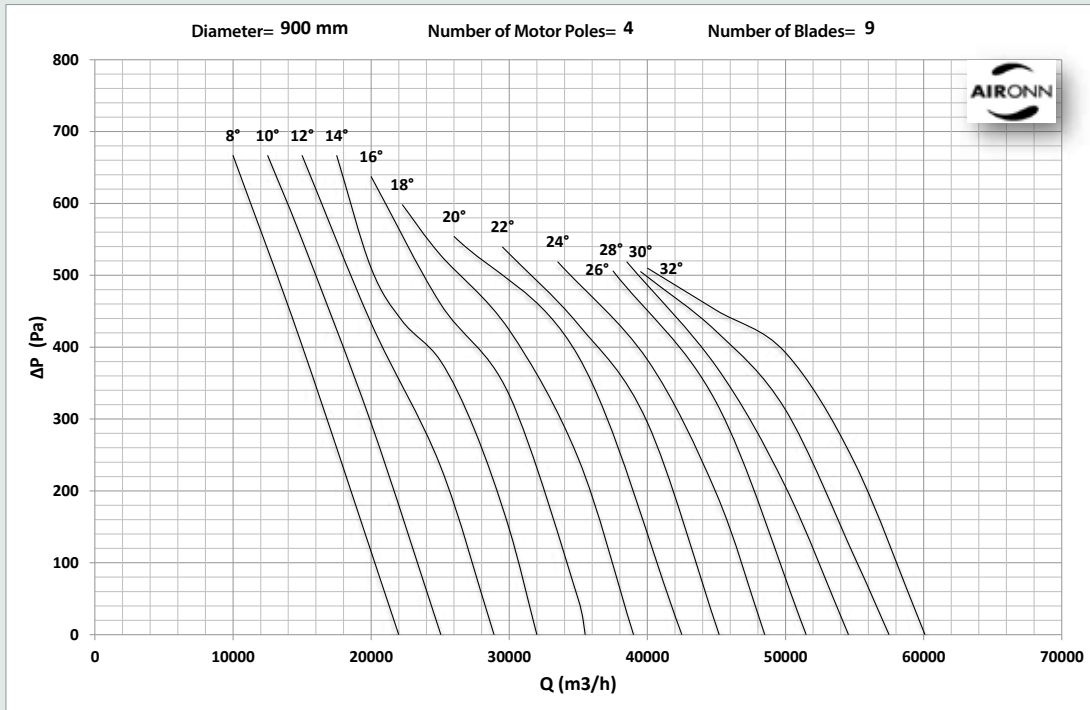

# Lobby Type Axial Smoke Exhaust Fan Series for Roofs

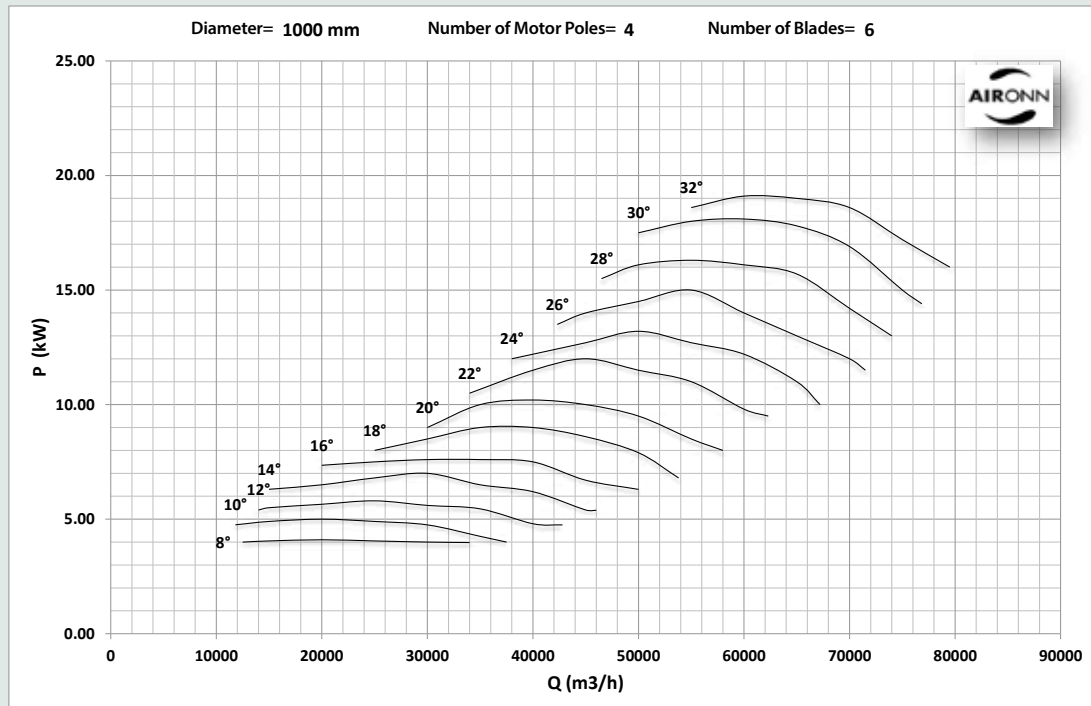
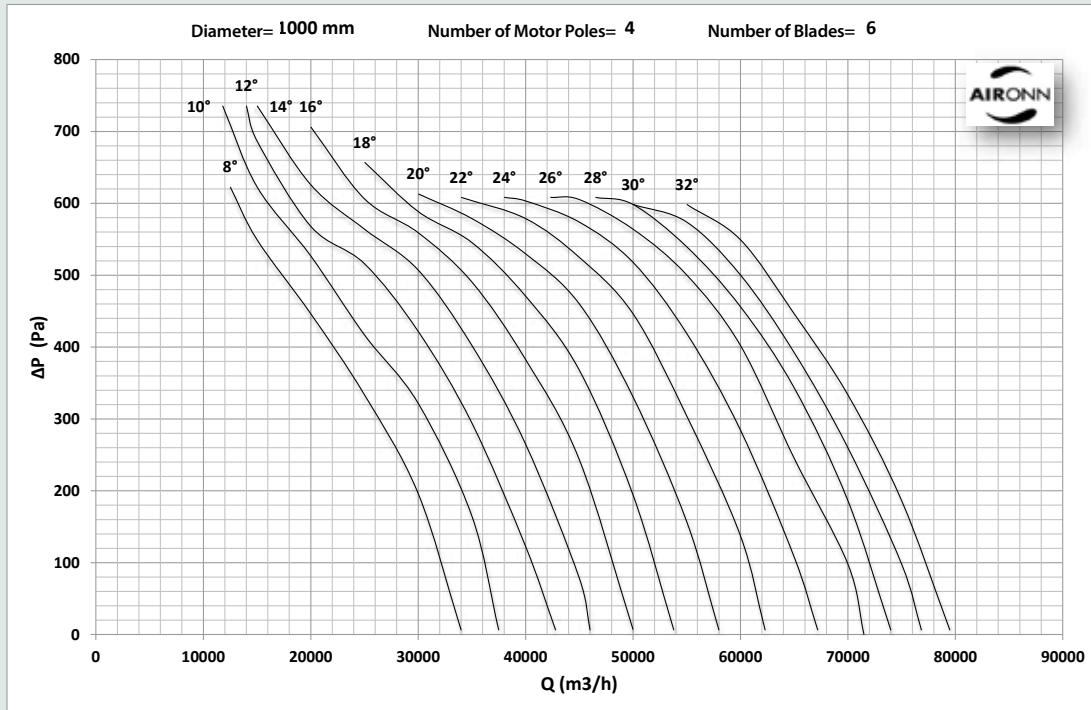



# Lobby Type Axial Smoke Exhaust Fan Series for Roofs

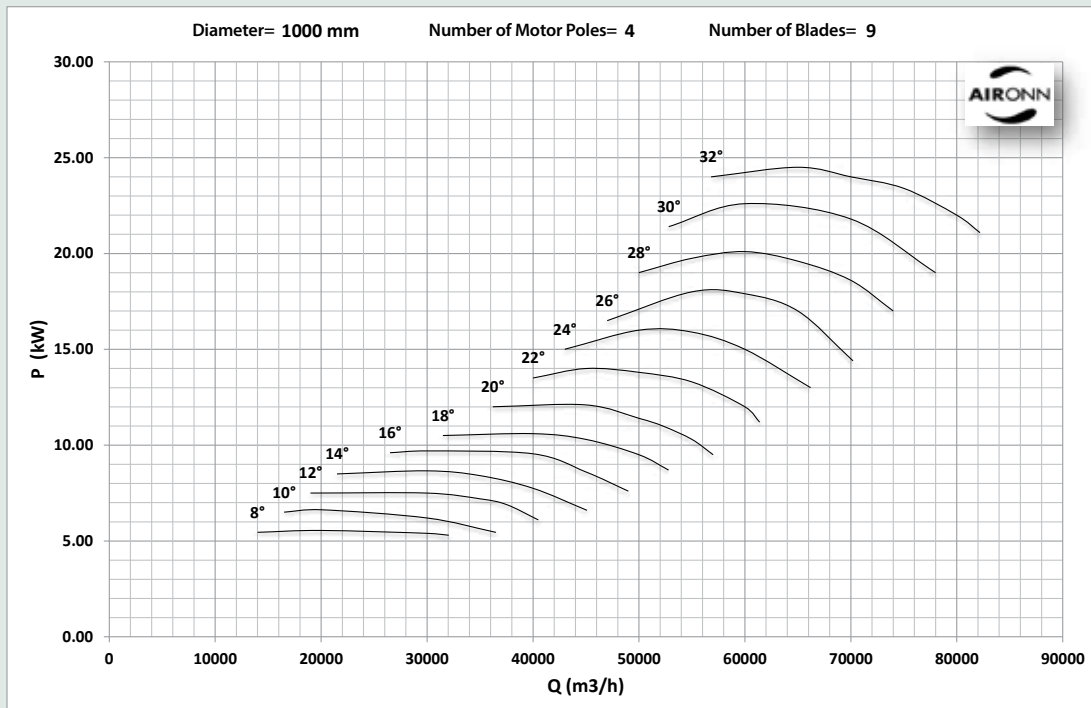
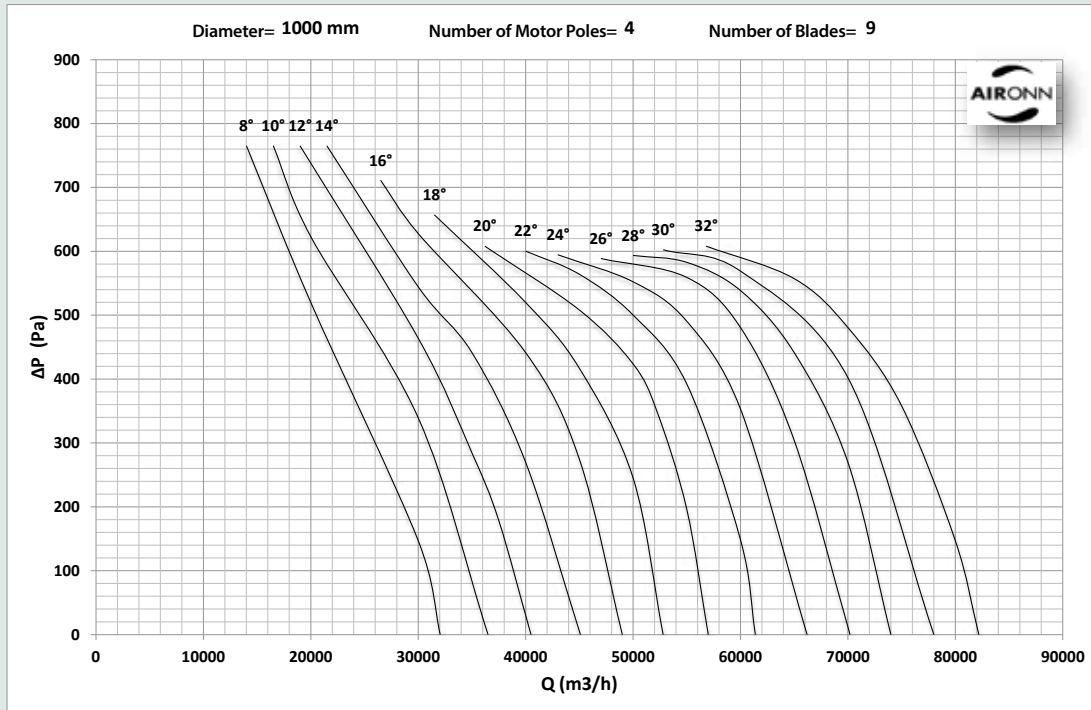

# Lobby Type Axial Smoke Exhaust Fan Series for Roofs

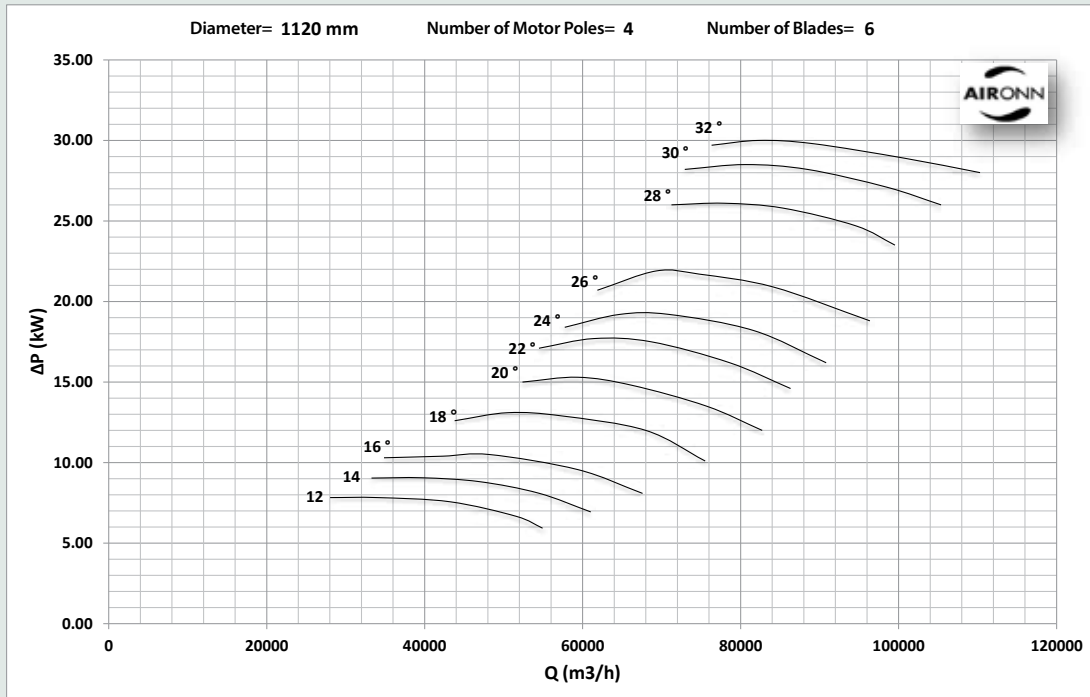
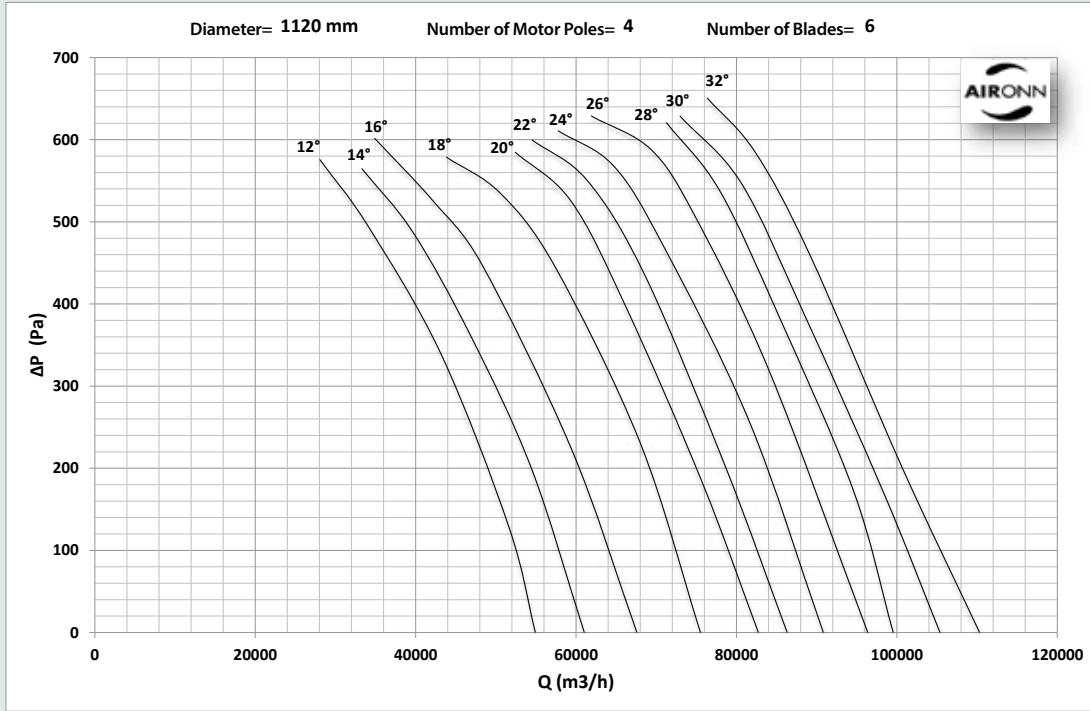

# Lobby Type Axial Smoke Exhaust Fan Series for Roofs

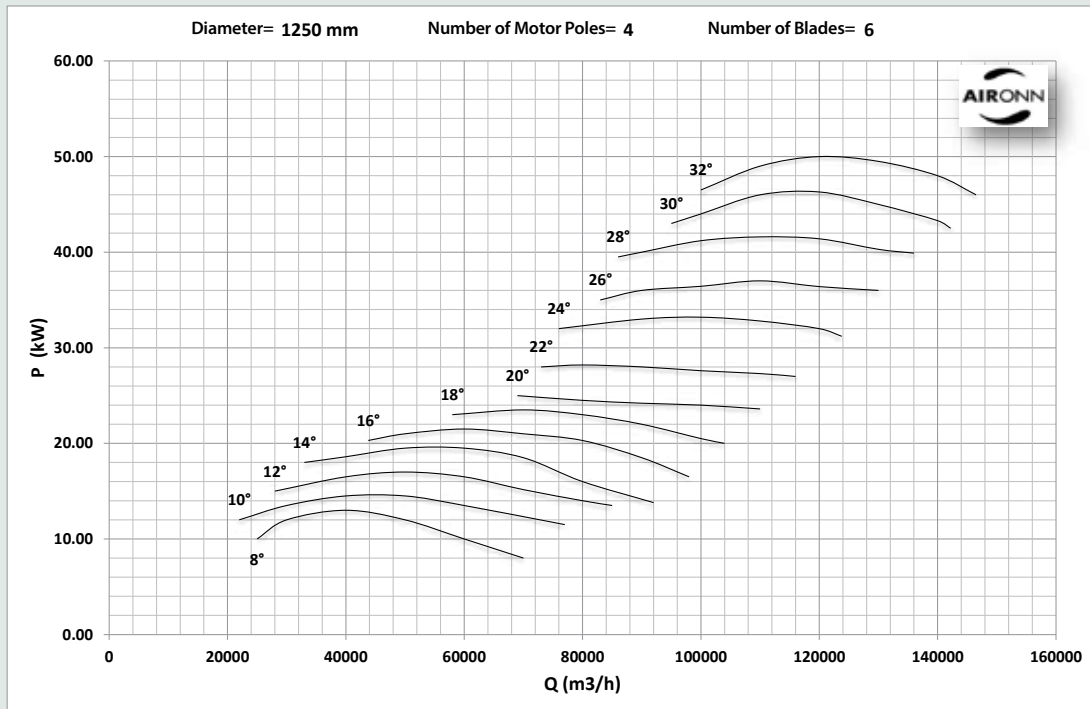
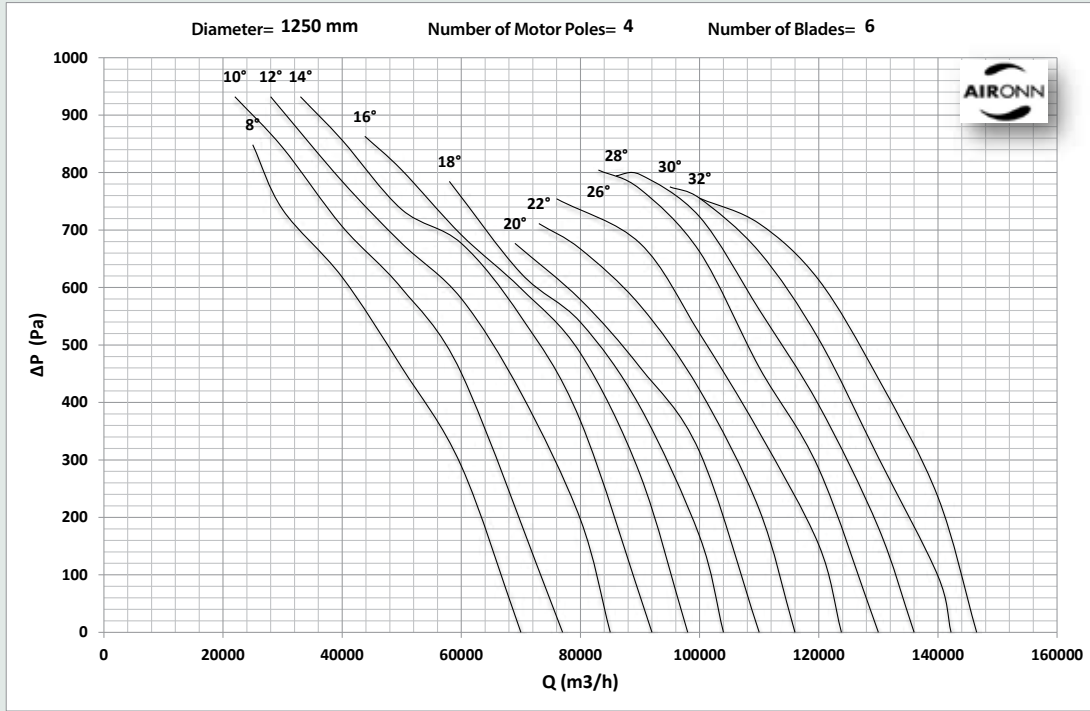

# Lobby Type Axial Smoke Exhaust Fan Series for Roofs

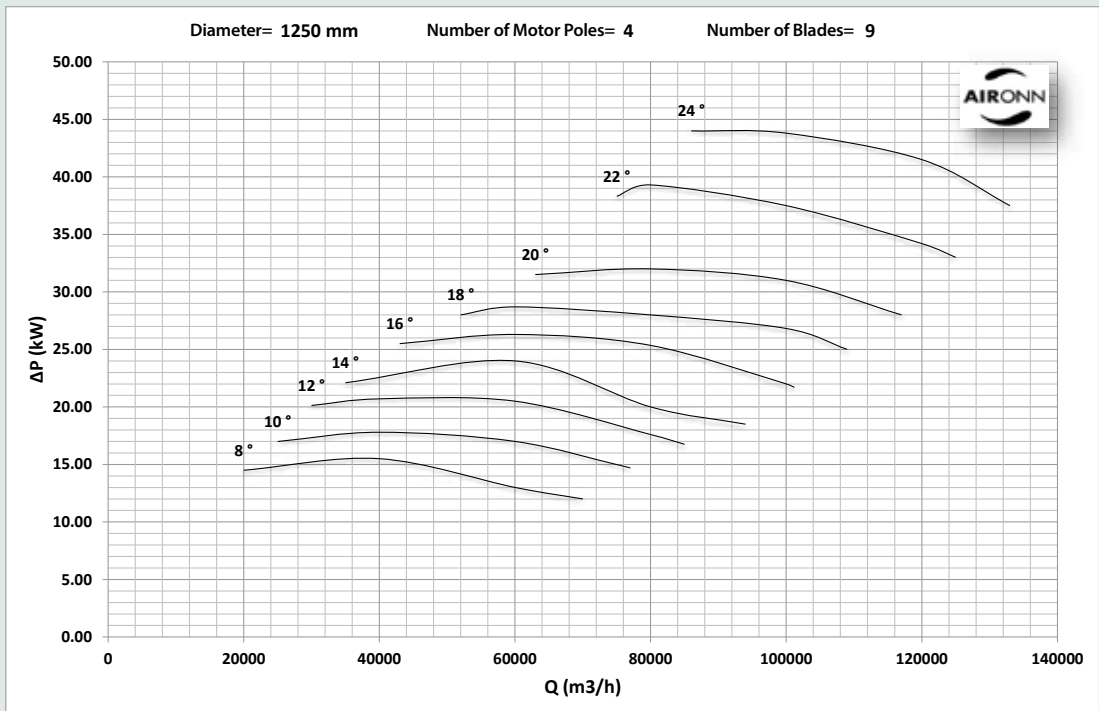
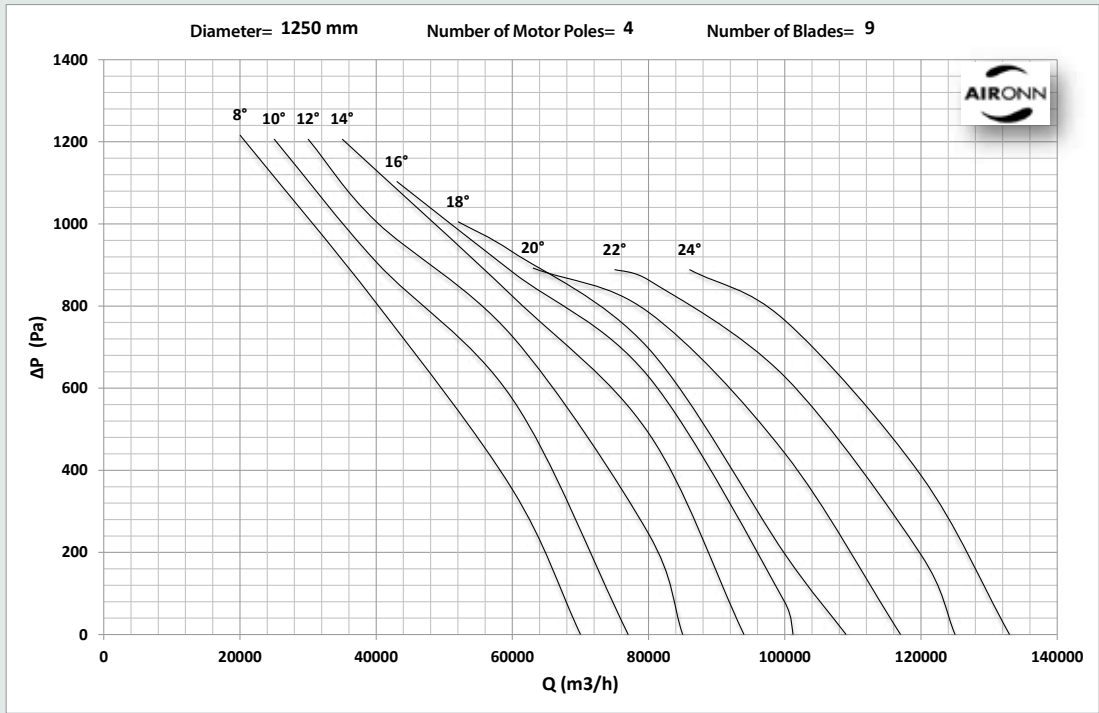



# Axial Type Silencer Body Smoke Exhaust Fan

Aironn Axial Type Silencer Body Smoke Exhaust Series fans with utility model patent have 300 °C-2 hours and 400 °C-2 hours certificates in compliance with EN 12101-3. Adjustable edge angle of the series in the range of diameters between 400 mm and 1250 mm presents a broad performance range. It also provides an advantage by precisely ensuring the required flow. Performance of the fans in Axial Type Silencer Body Smoke Exhaust Fan Series have been tested in accordance with AMCA 210-07 standard.

## Fan Body

Fan bodies are made of high quality galvanized coated sheet metal. 70 kg/m<sup>3</sup> density nonflammable stone wool placed inside the double-walled fan body provides high sound absorption performance.

## Fan Blades

Aerodynamic fan blades are made of ETIAL 171 with injection moulding method. They are statically and dynamically balanced in compliance with ISO 1940/1-2003.

## Motor

IP 55 motors with class H insulation are available in single cycle or double cycle options. If requested, single cycle motors can be used with inverters.

## Electricity

IP 55 electric terminal box made of aluminium is standard.

## Accessories

Horizontal Mount Foot, Vertical Mount Foot, Silencer (50), Silencer (100), Silencer with Pod (100), Counter Flange, Back Draft Damper, Protection Grill, Spring Insulator, Inlet Cone, Flexible Coupling, Pacco (Package) Switch, Vibration Sensor, Inverter



# Axial Type Silencer Body Fresh Air Fan

Aironn Utility model patented Axial Type Silencer Body Smoke Exhaust Fans are suitable to operate at maximum 55 °C. Adjustable edge angle of the series in the range of diameters between 400 mm and 1250 mm presents a broad performance range. It also provides an advantage by precisely ensuring the required flow. Performance of the fans in Axial Type Silencer Body Smoke Exhaust Fan Series have been tested in accordance with AMCA 210-07 standard.

## Fan Body

Fan bodies are made of high quality galvanize coated sheet metal. 70 kg/m<sup>3</sup> density nonflammable stone wool placed inside the double-walled fan body provides high sound absorption performance.

## Fan Blades

Aerodynamic fan blades are made of ETIAL 171 with injection moulding method. They are statically and dynamically balanced in compliance with ISO 1940/1-2003.

## Motor

IP 55 motors with class F insulation are available in single cycle or double cycle options. If requested, single cycle motors can be used with inverters.

## Electricity

IP 55 electric terminal box made of plastic is standard.

## Accessories

Horizontal Mount Foot, Vertical Mount foot, Silencer (50), Silencer (100), Silencer with Pod (100), Counter Flange, Back Draft Damper, Protection Grill, Spring Insulator, Inlet Cone, Flexible Coupling, Pacco (Package) Switch, Vibration Sensor, Inverter

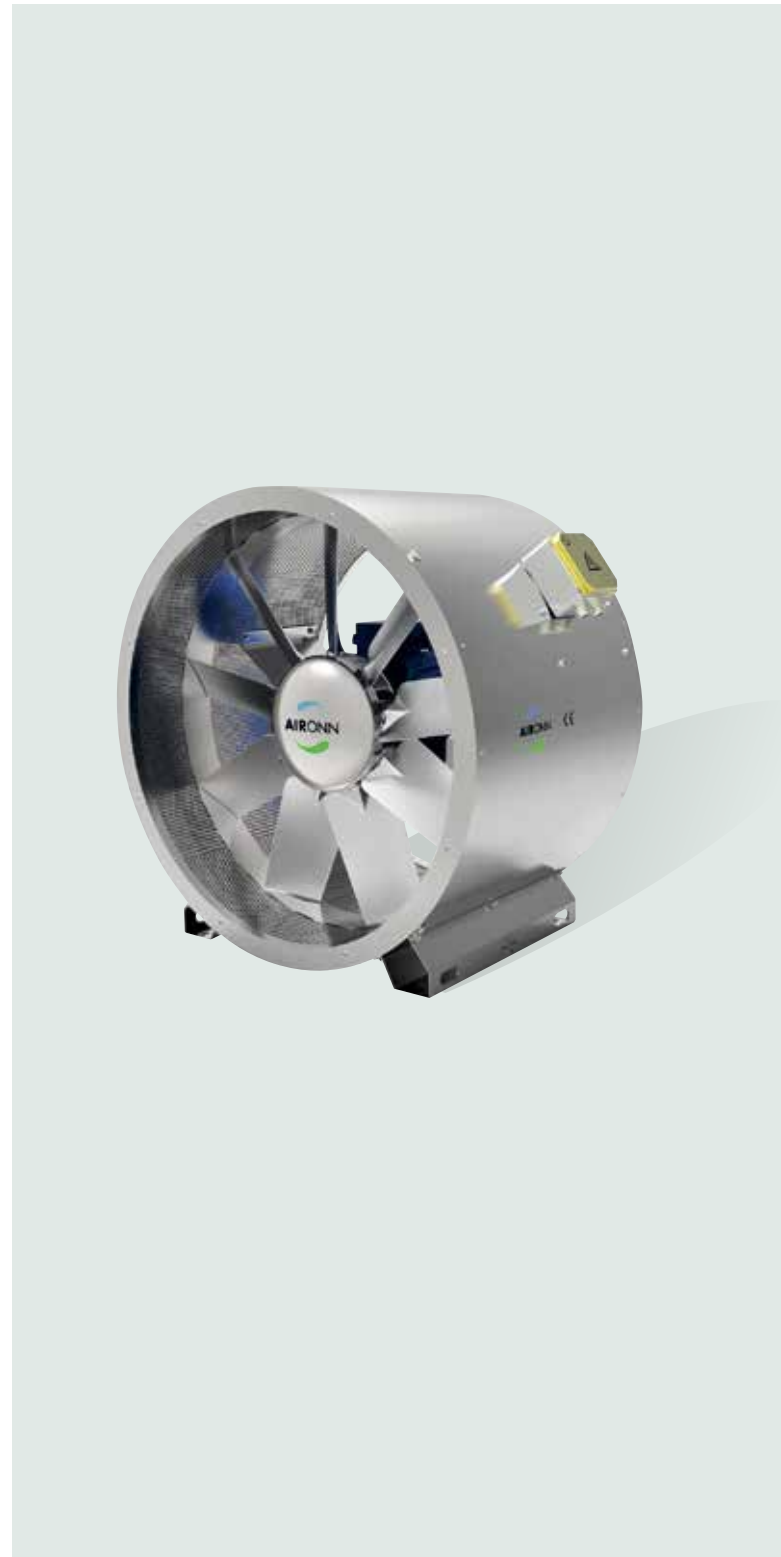

## Axial Type Silencer Body Smoke Exhaust & Fresh Air Fan

### Dimensions

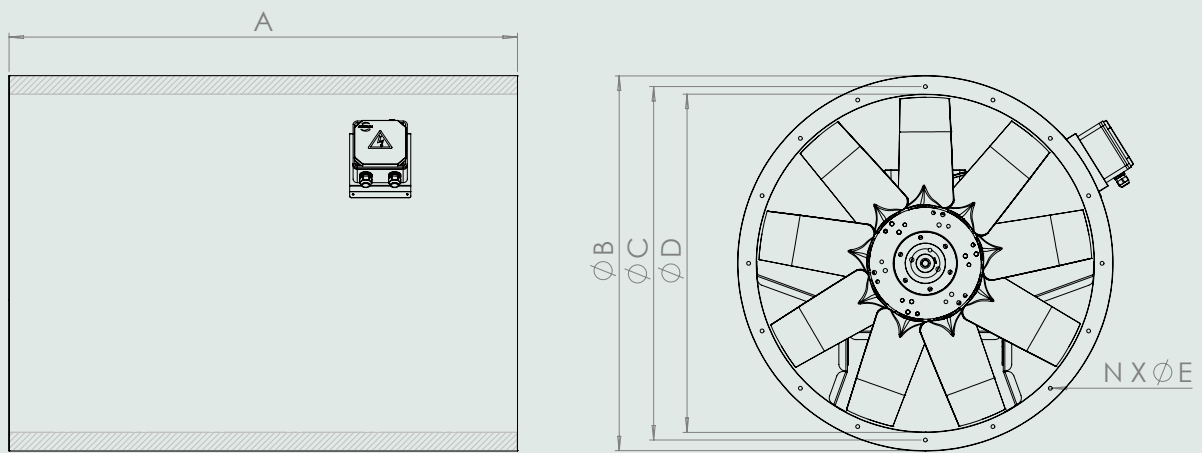

	A	B	C	D	N X Ø E
400	800	500	430	400	8 x 11
450	1000	550	484	450	8 x 11
500	1000	600	537	500	8 x 11
560	1000	660	597	560	8 x 11
630	1250	730	667	630	8 x 11
710	1250	810	747	710	8 x 11
800	1250	900	844	800	16 x 11
900	1250	1000	944	900	16 x 13
1000	1500	1100	1044	1000	16 x 13
1250	1500	1350	1294	1250	16 x 13



## Axial Type Silencer Body Fresh Air Fan

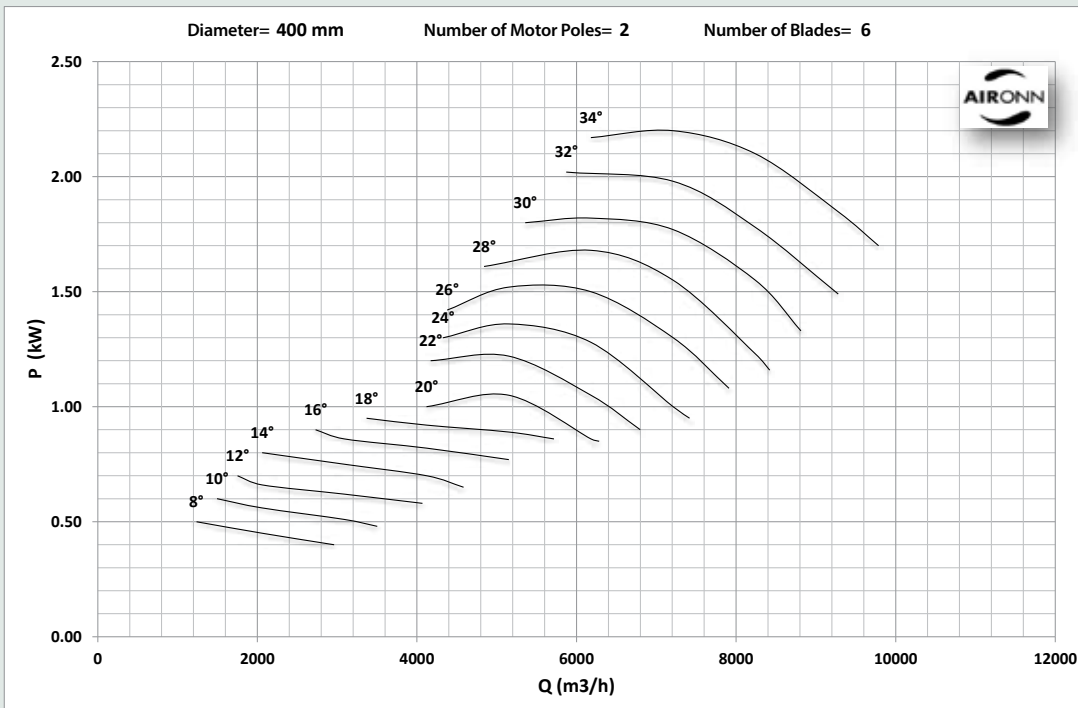
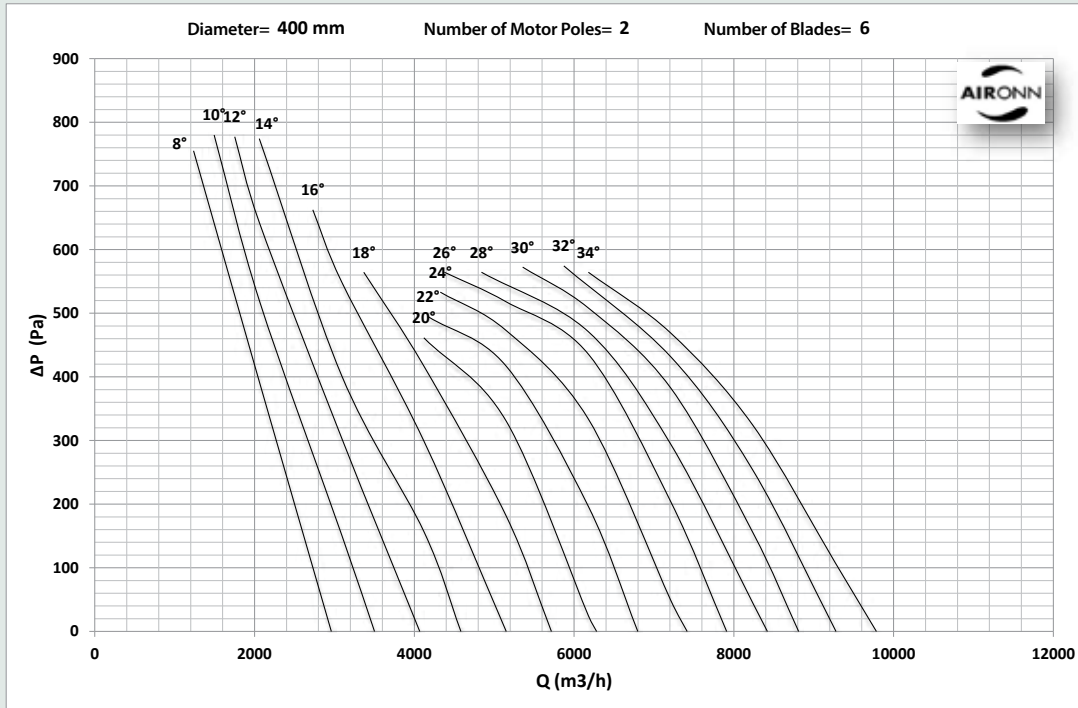

## Axial Type Silencer Body Fresh Air Fan

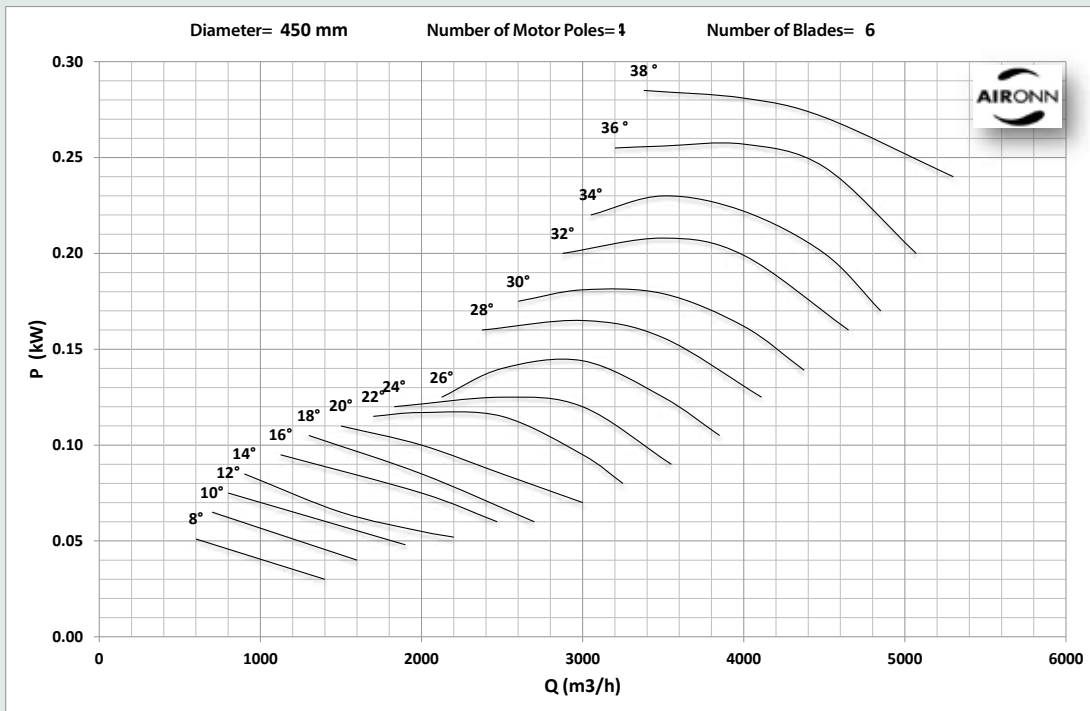
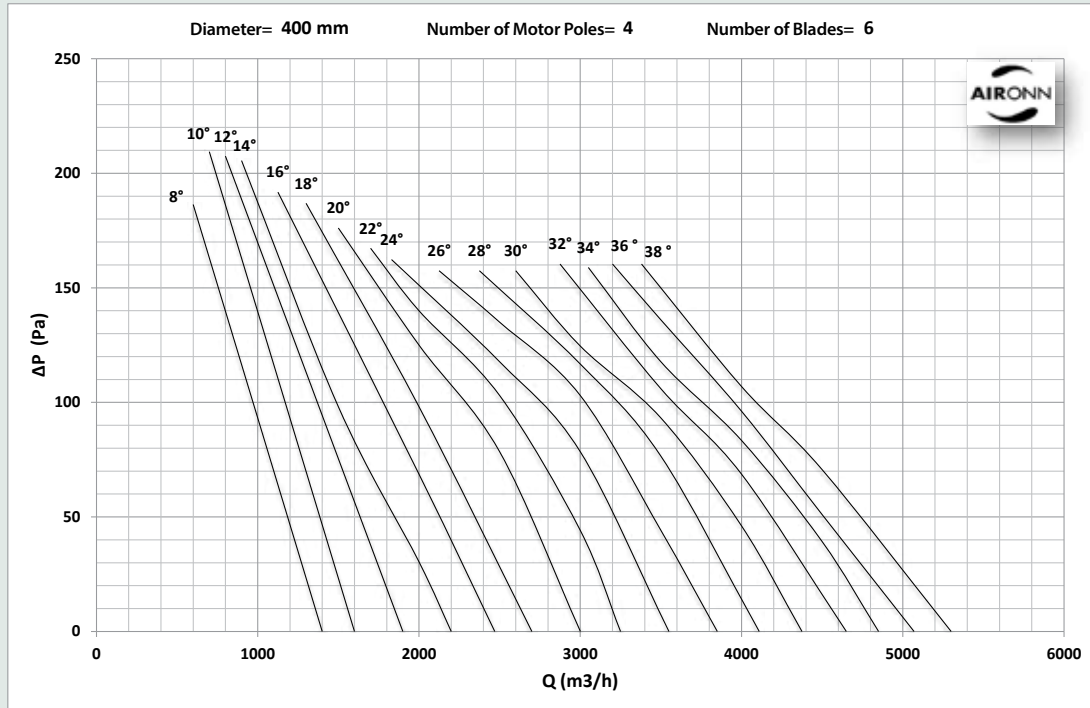

## Axial Type Silencer Body Fresh Air Fan

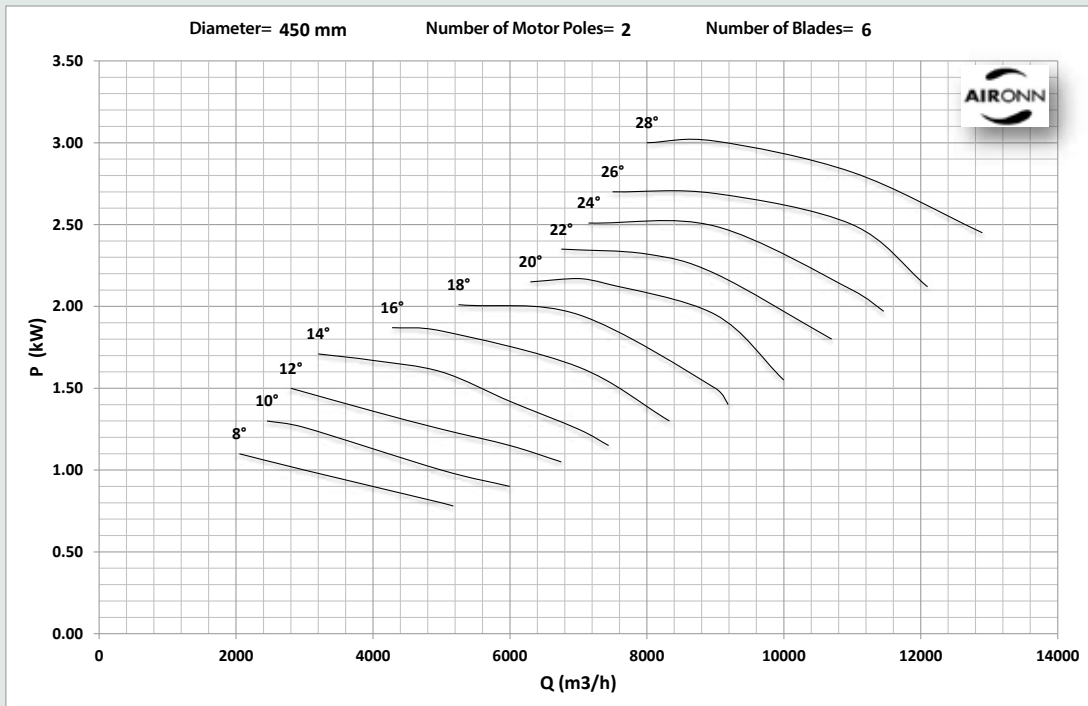
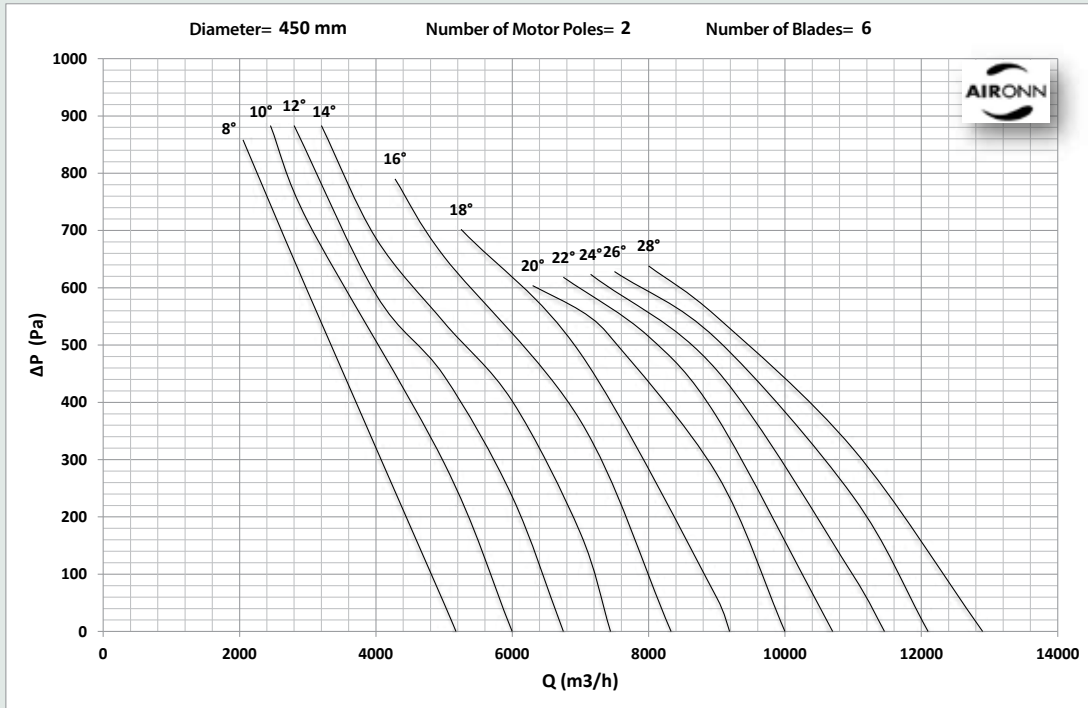

## Axial Type Silencer Body Fresh Air Fan

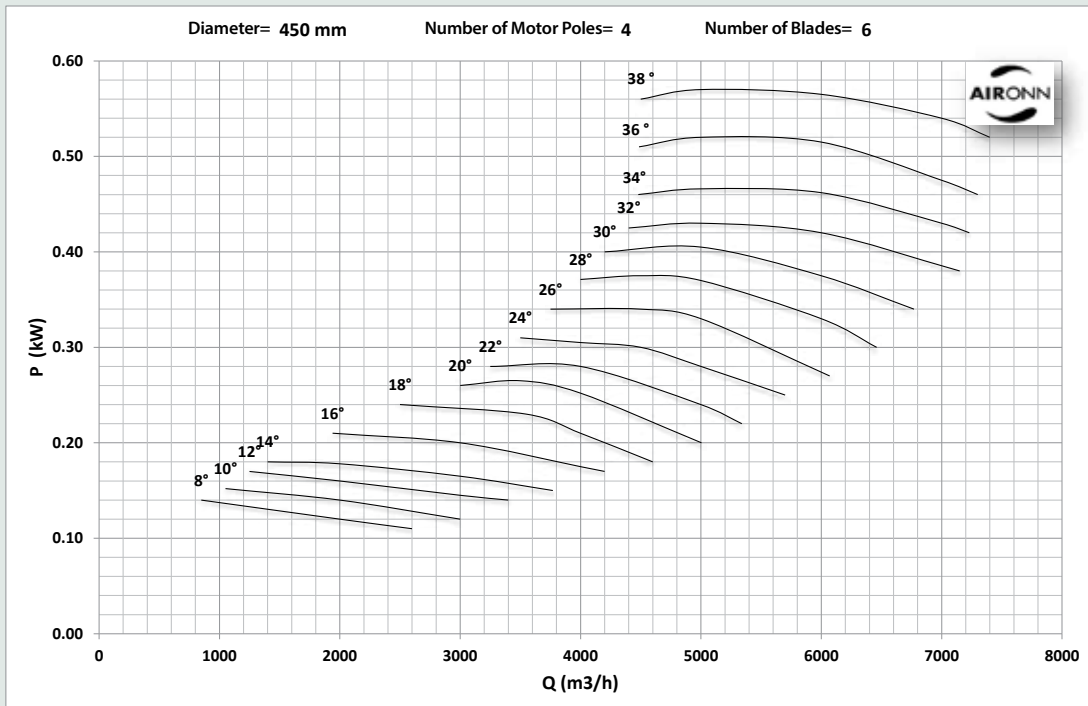
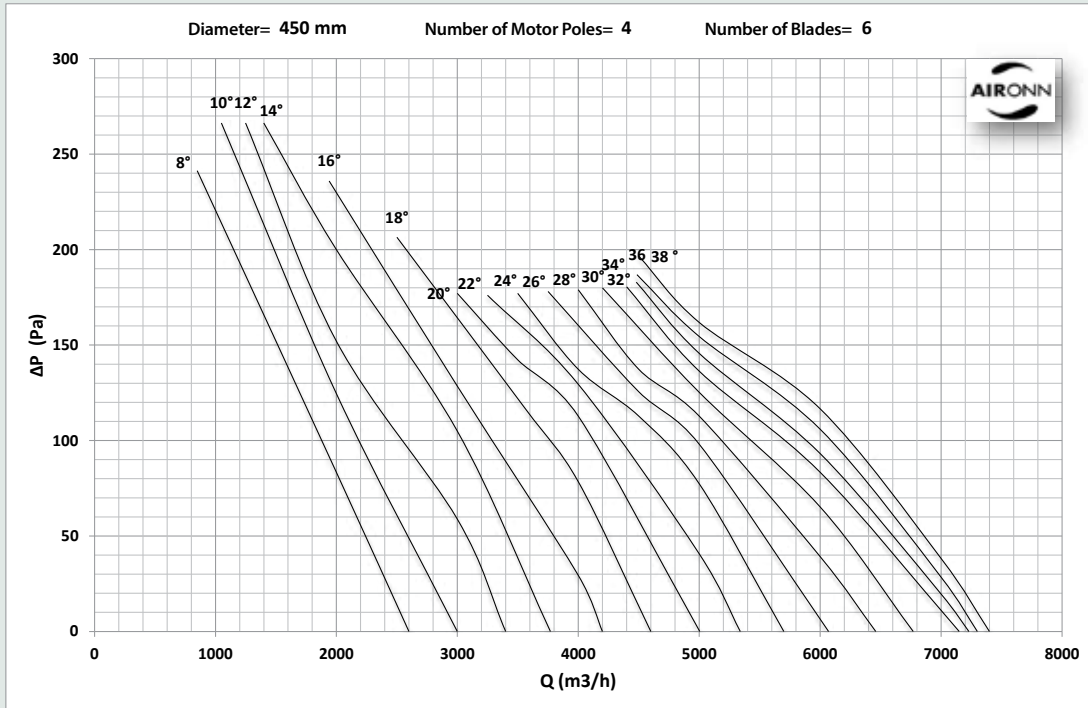

# Axial Type Silencer Body Fresh Air Fan

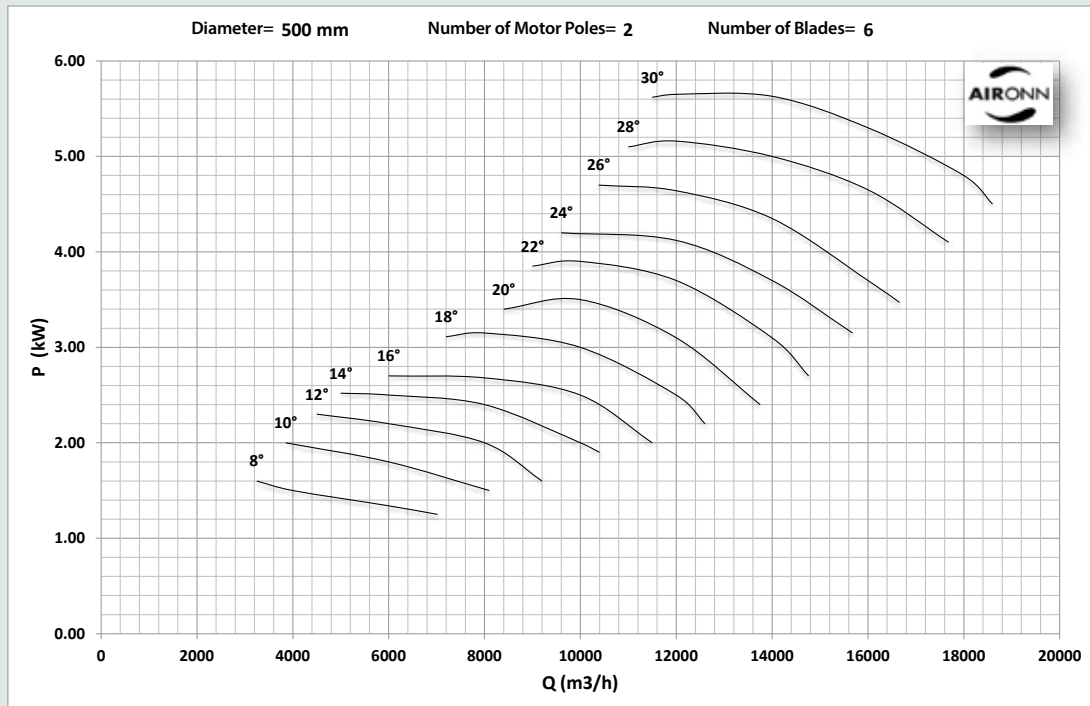
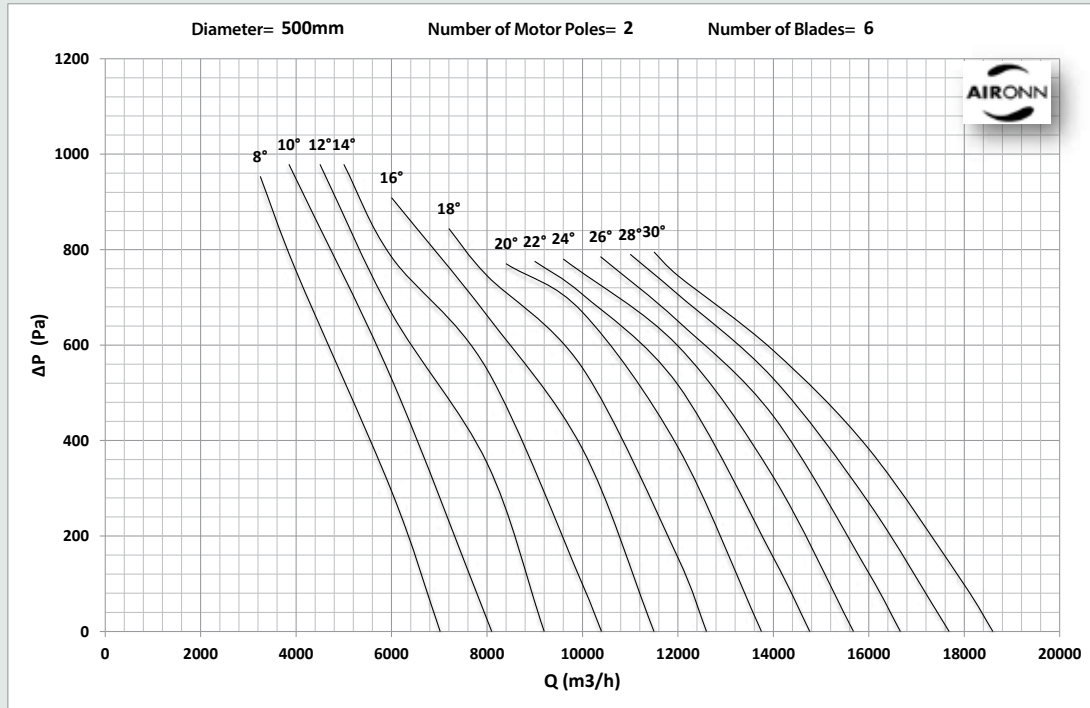

## Axial Type Silencer Body Fresh Air Fan

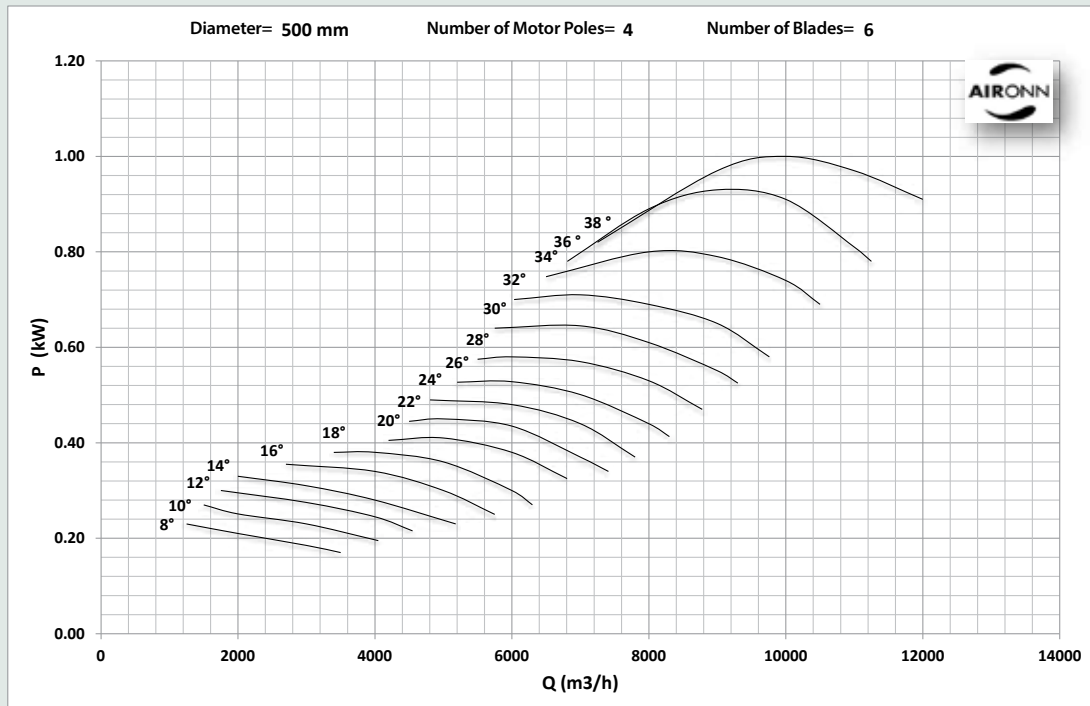
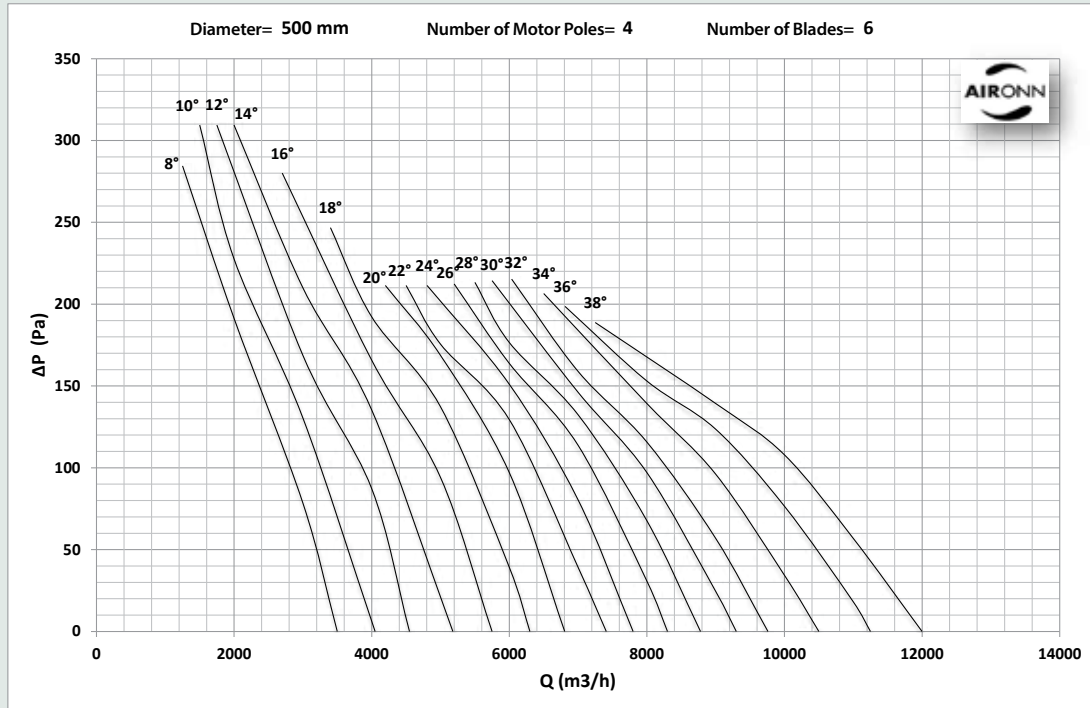

# Axial Type Silencer Body Fresh Air Fan

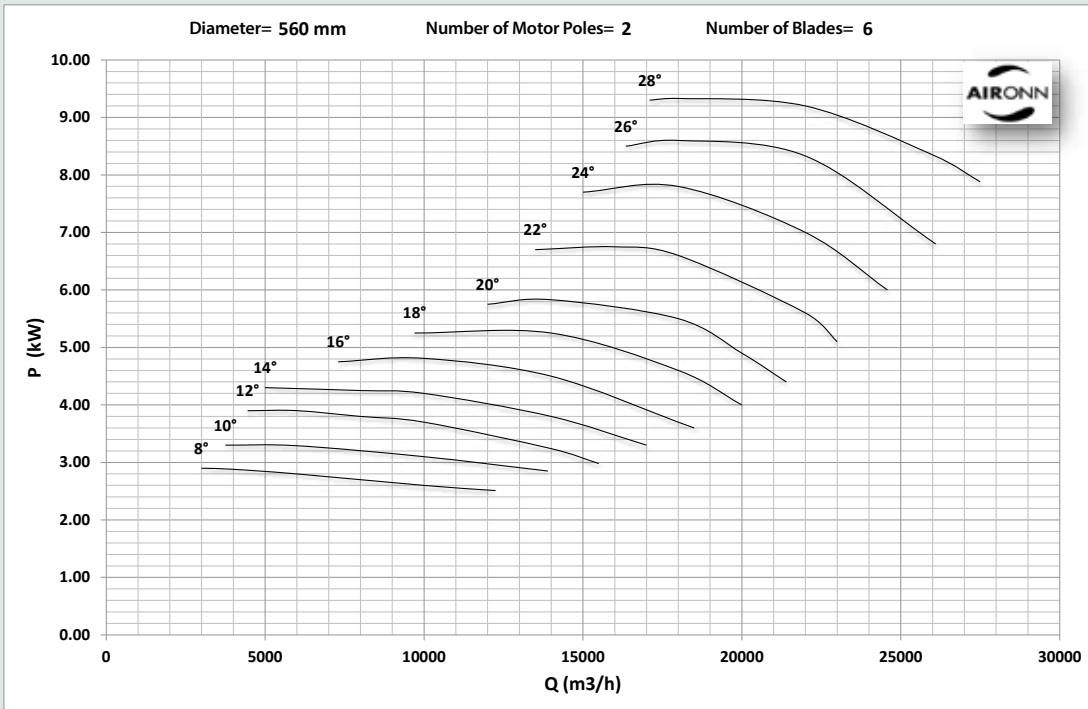
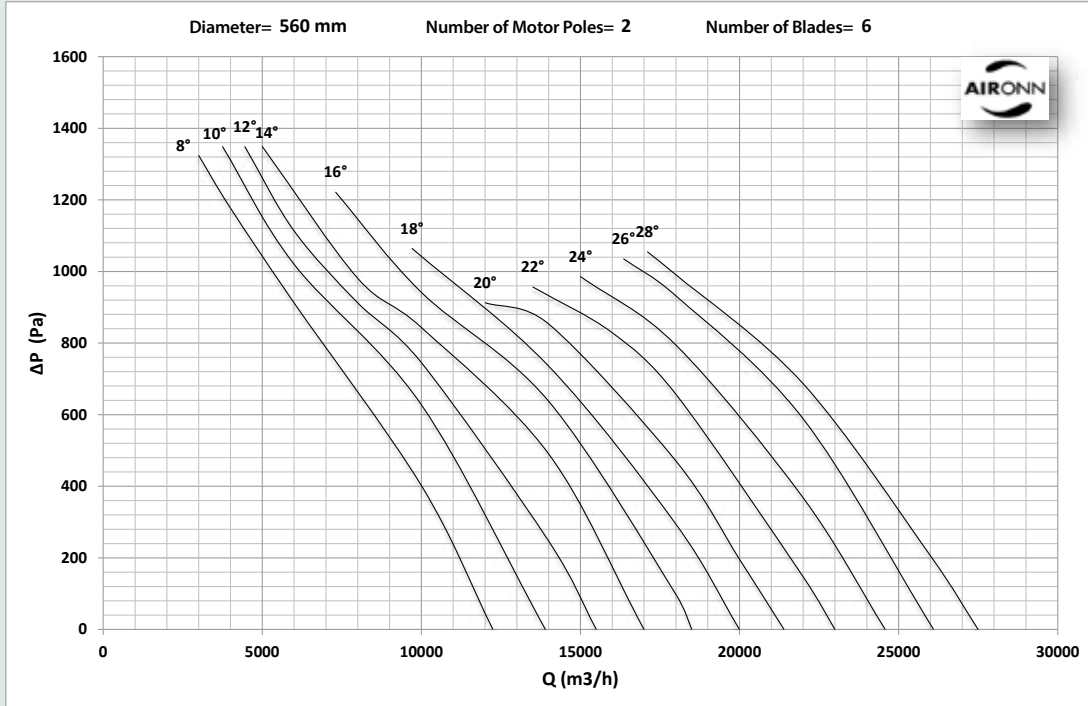

## Axial Type Silencer Body Fresh Air Fan

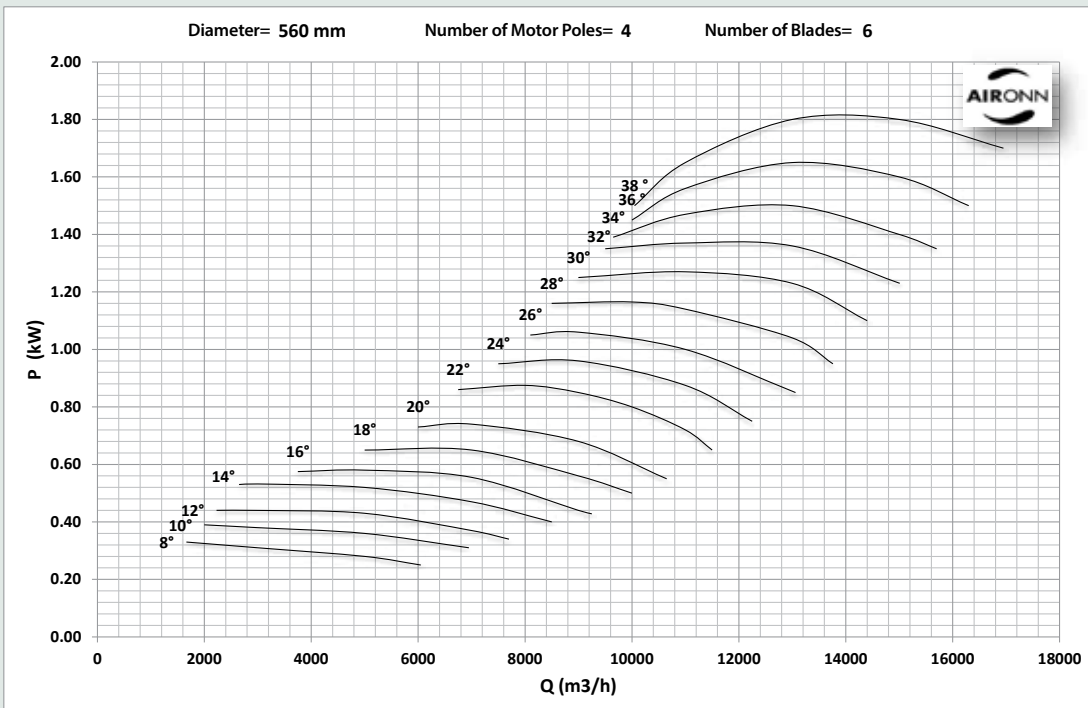
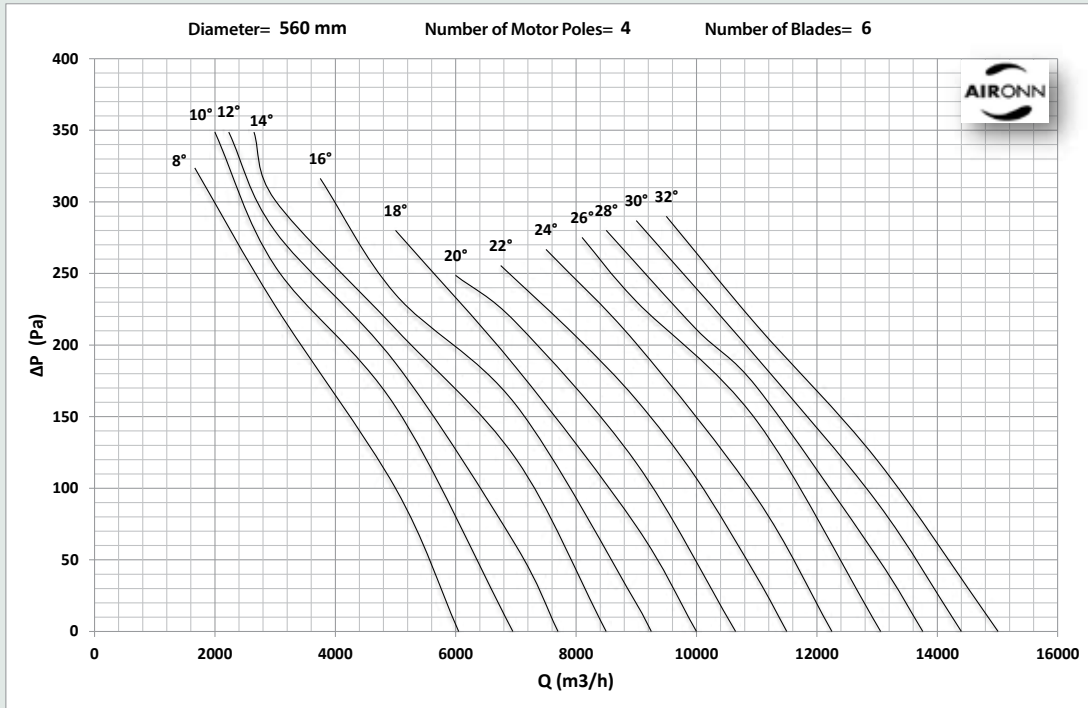



## Axial Type Silencer Body Fresh Air Fan

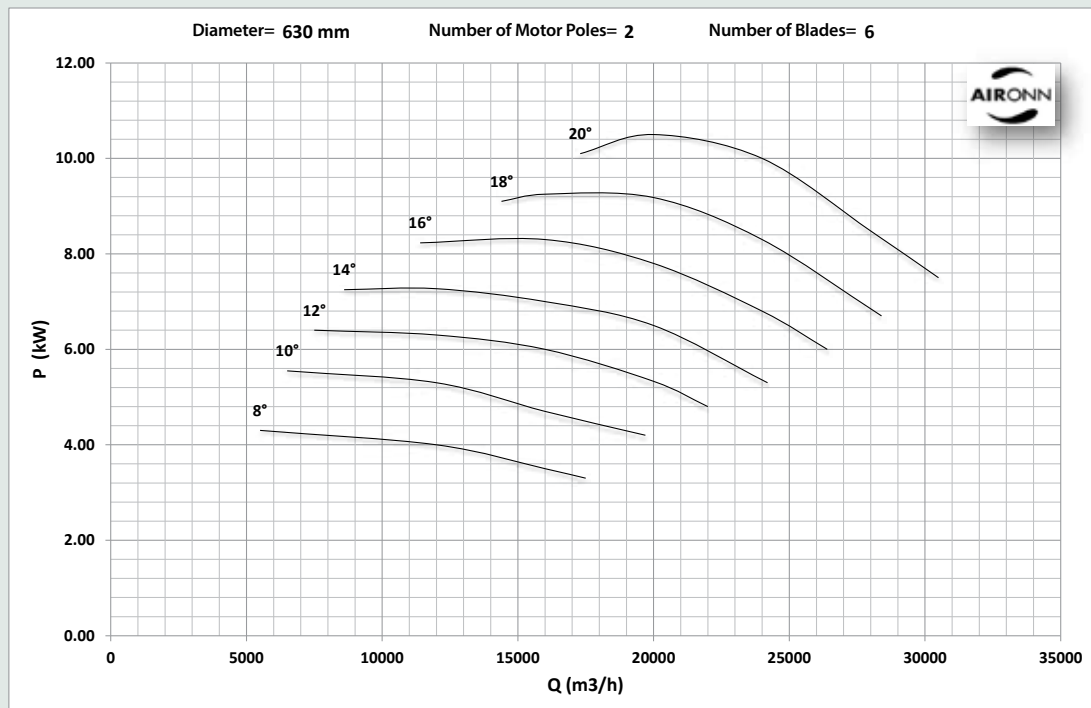
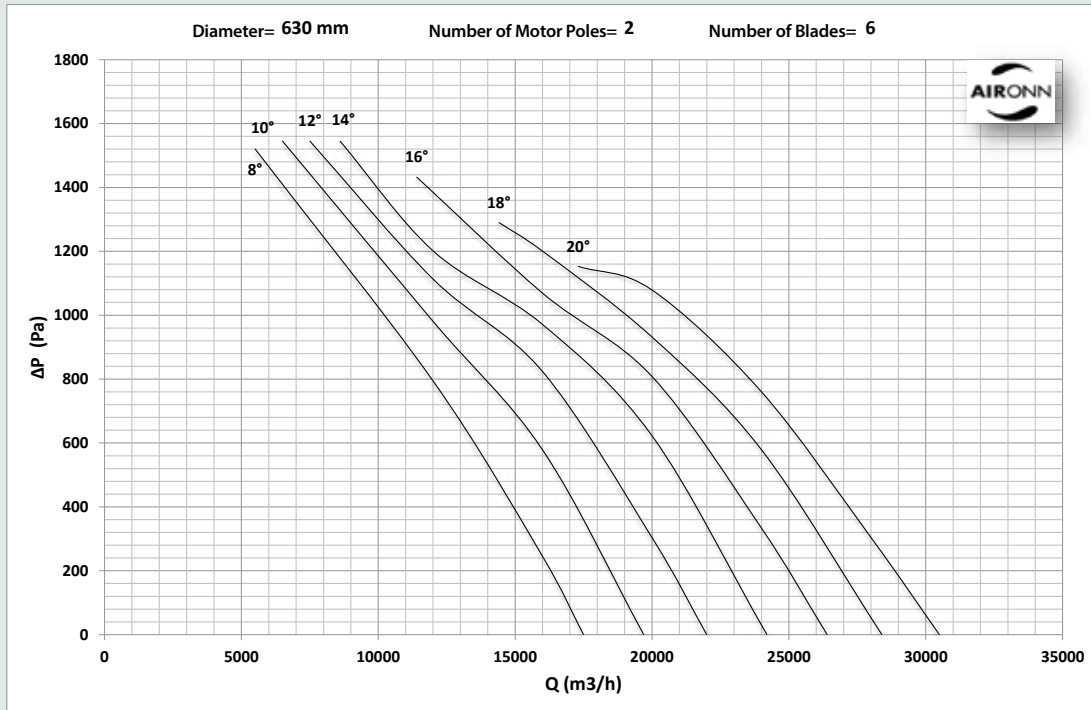

## Axial Type Silencer Body Fresh Air Fan

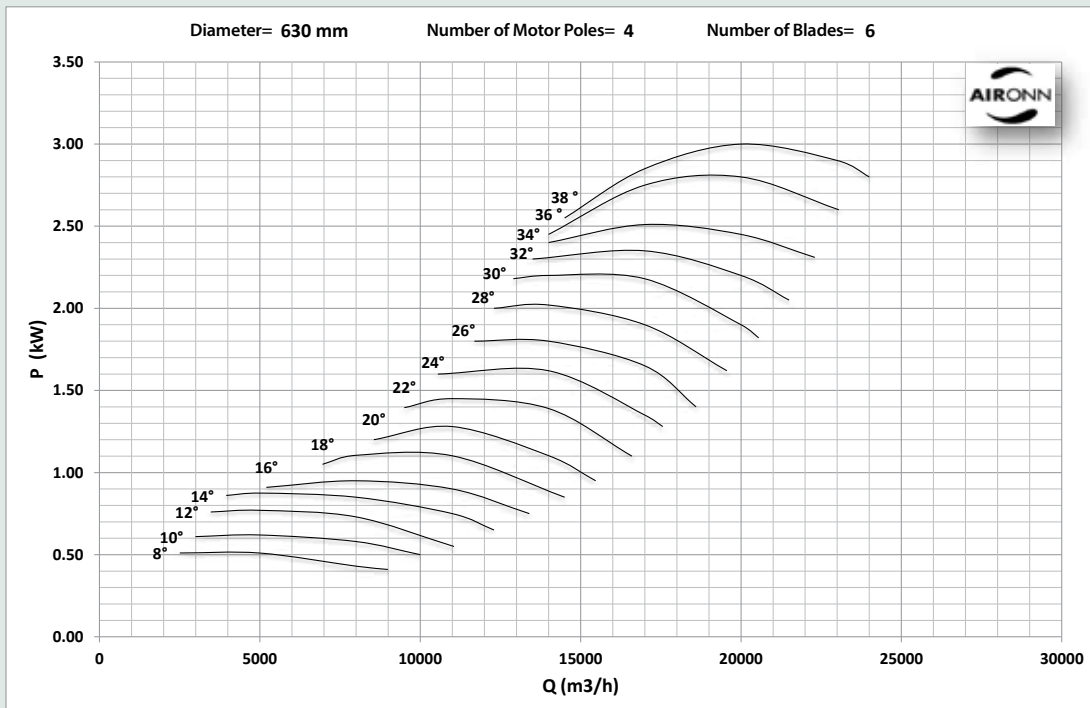
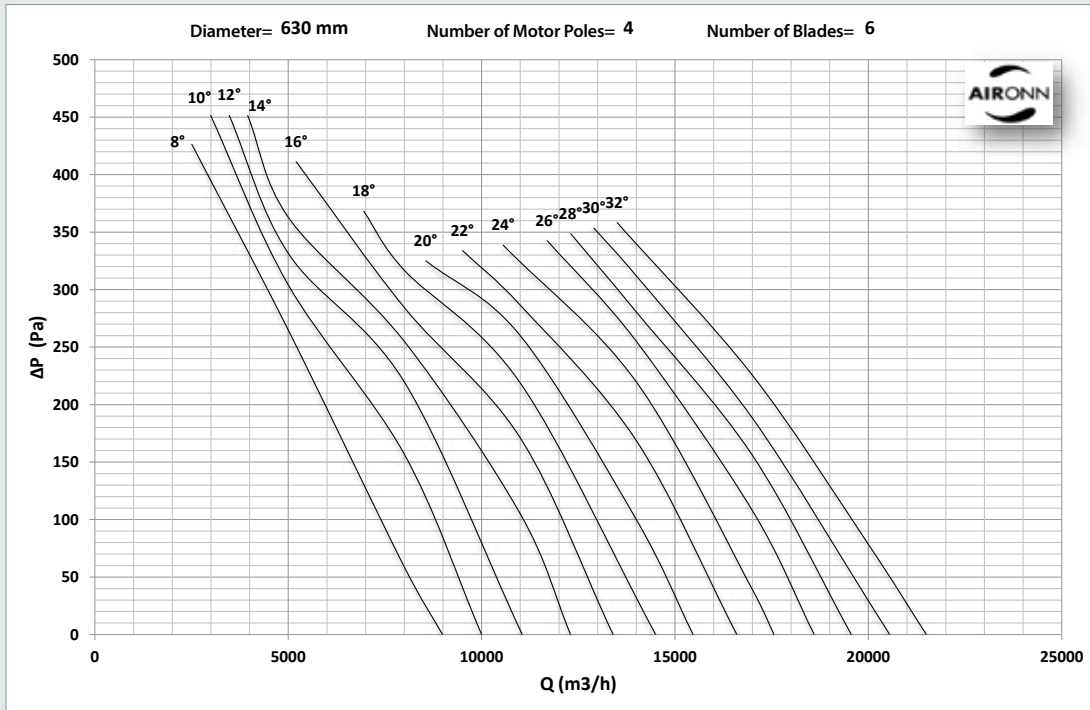

## Axial Type Silencer Body Fresh Air Fan

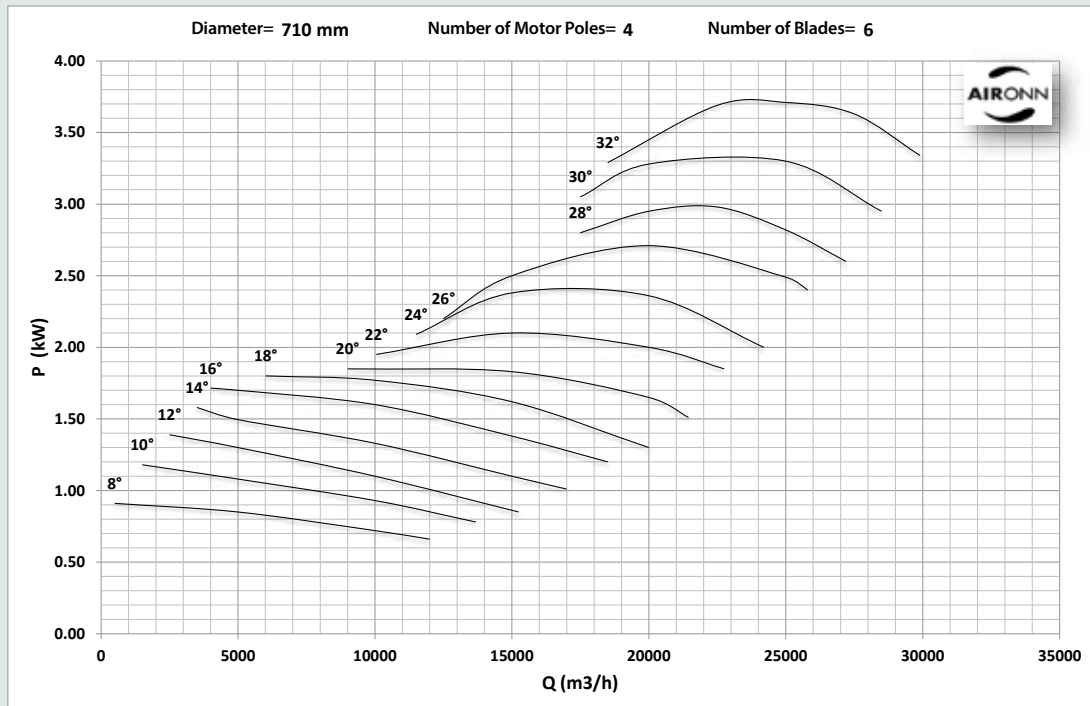
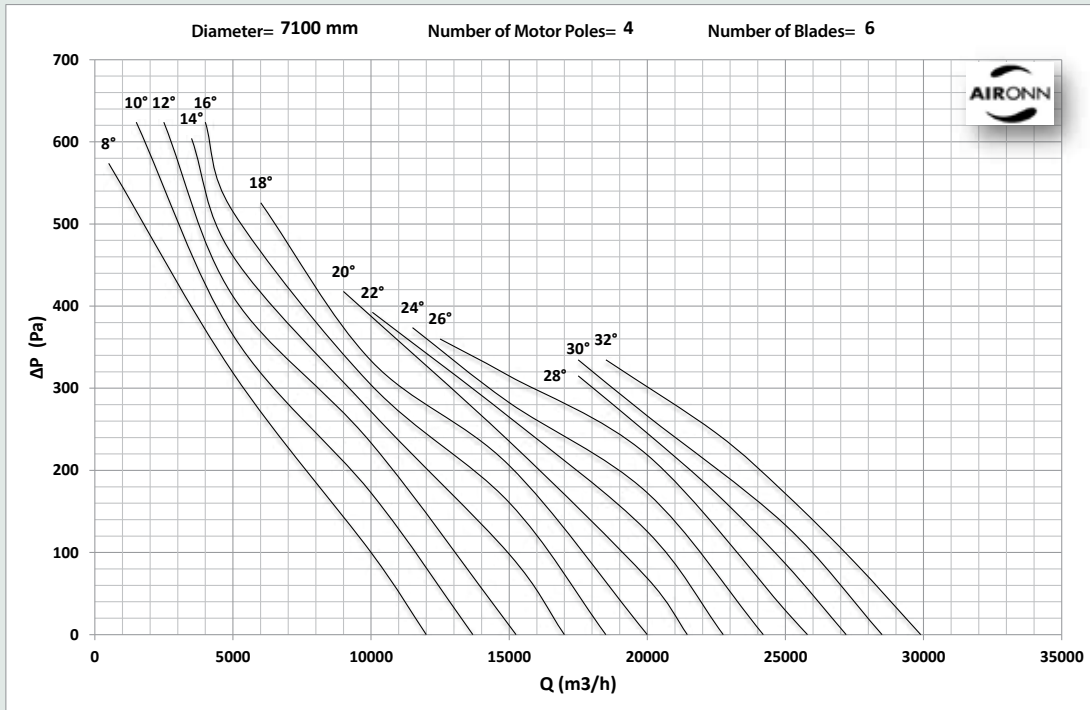

## Axial Type Silencer Body Fresh Air Fan

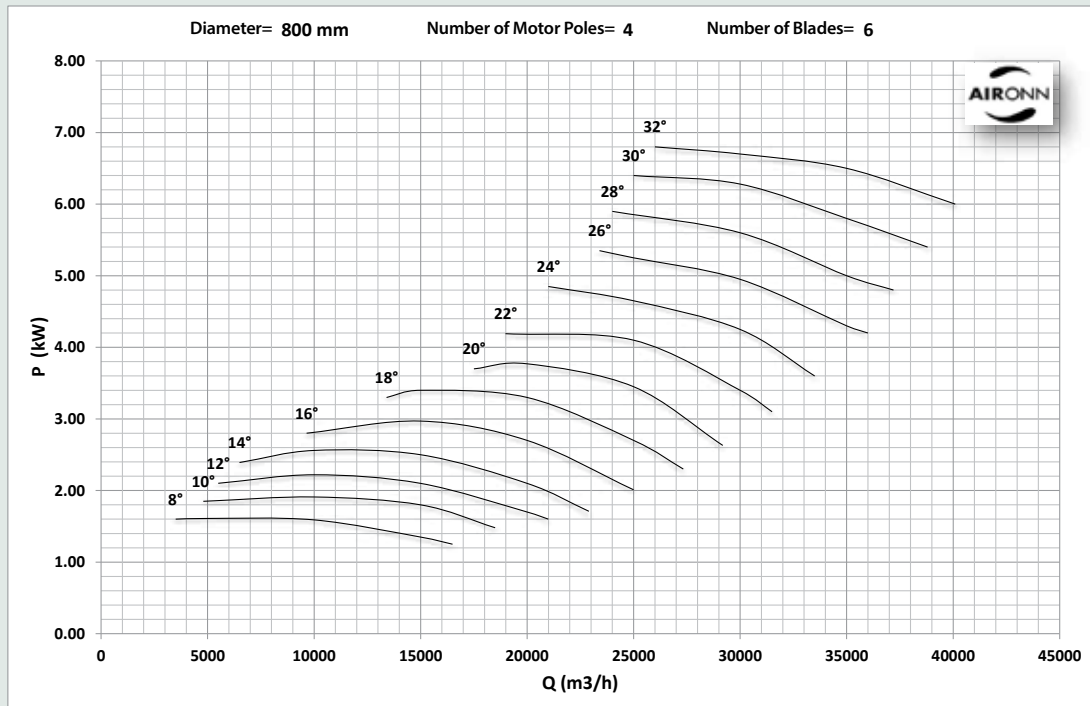
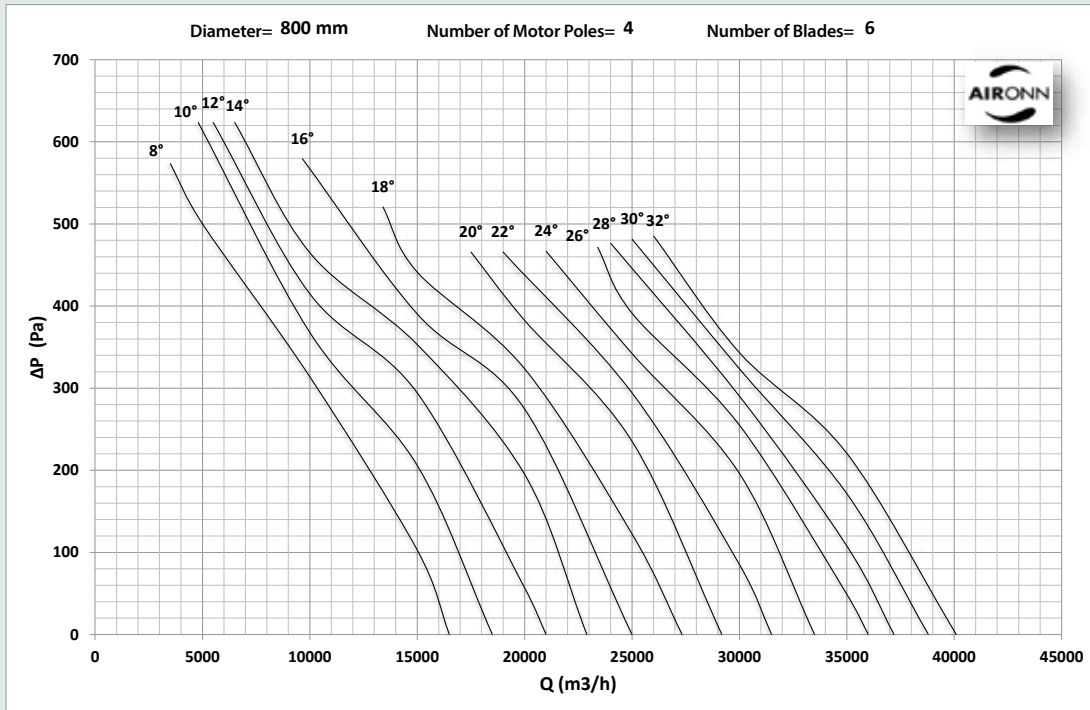

## Axial Type Silencer Body Fresh Air Fan

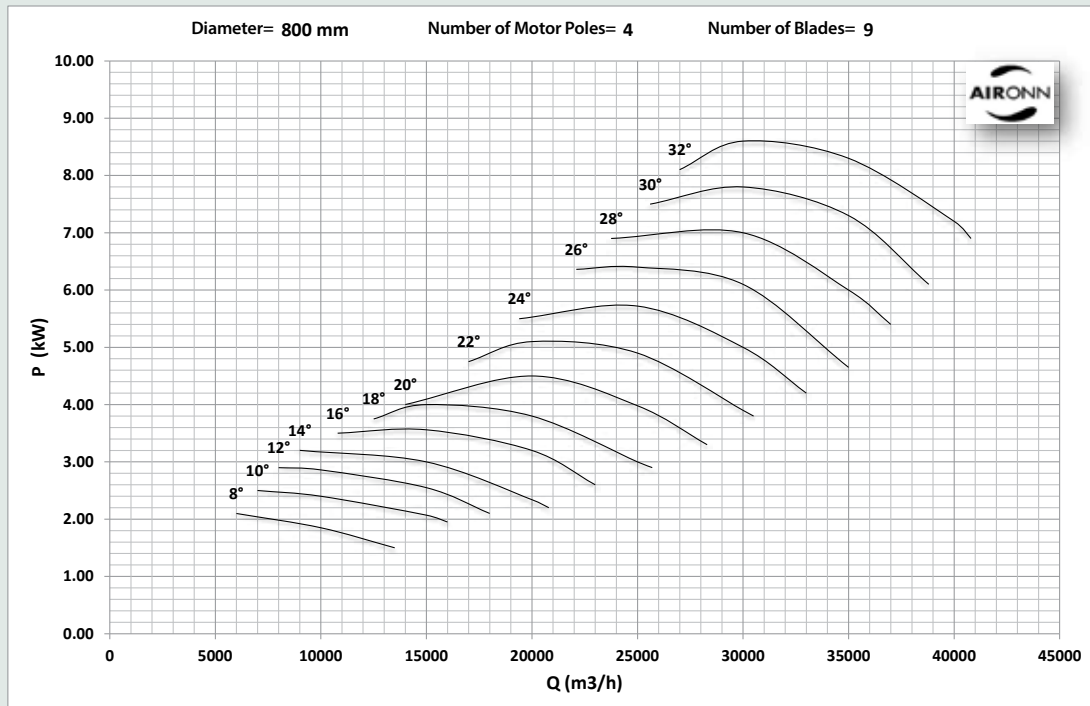
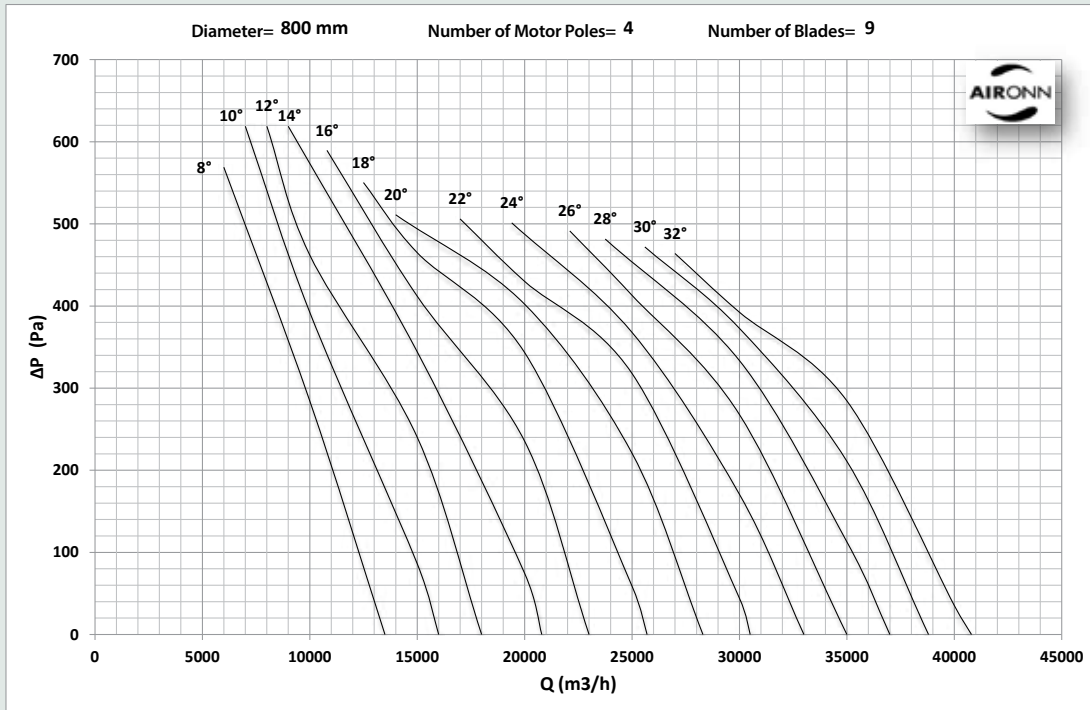

# Axial Type Silencer Body Fresh Air Fan

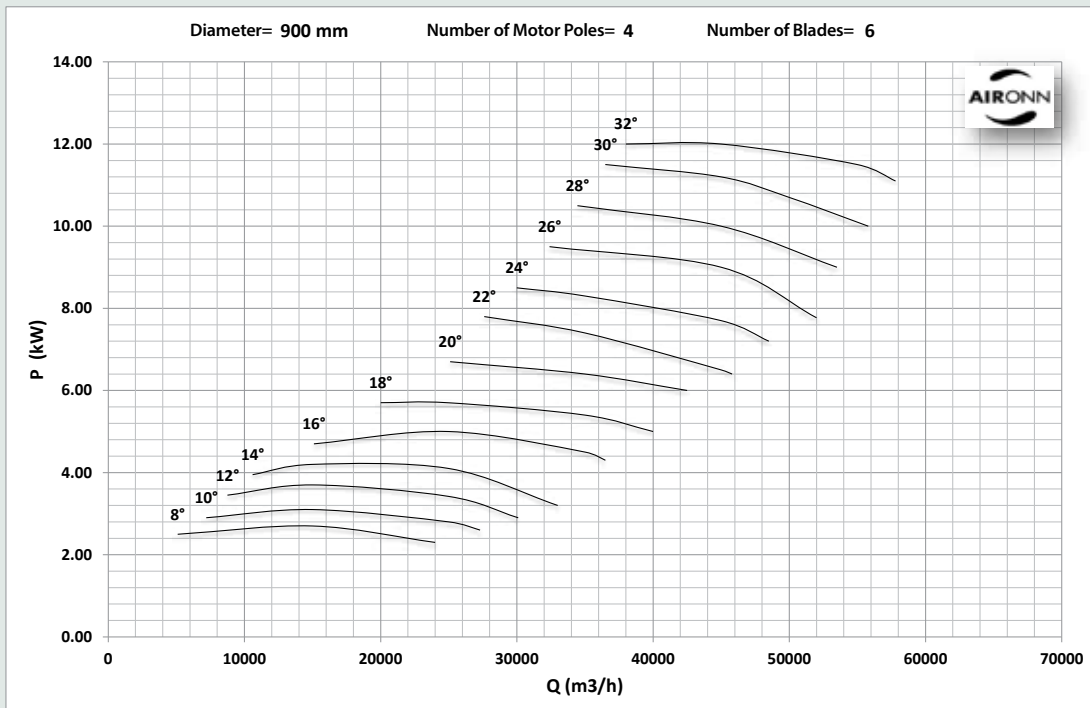
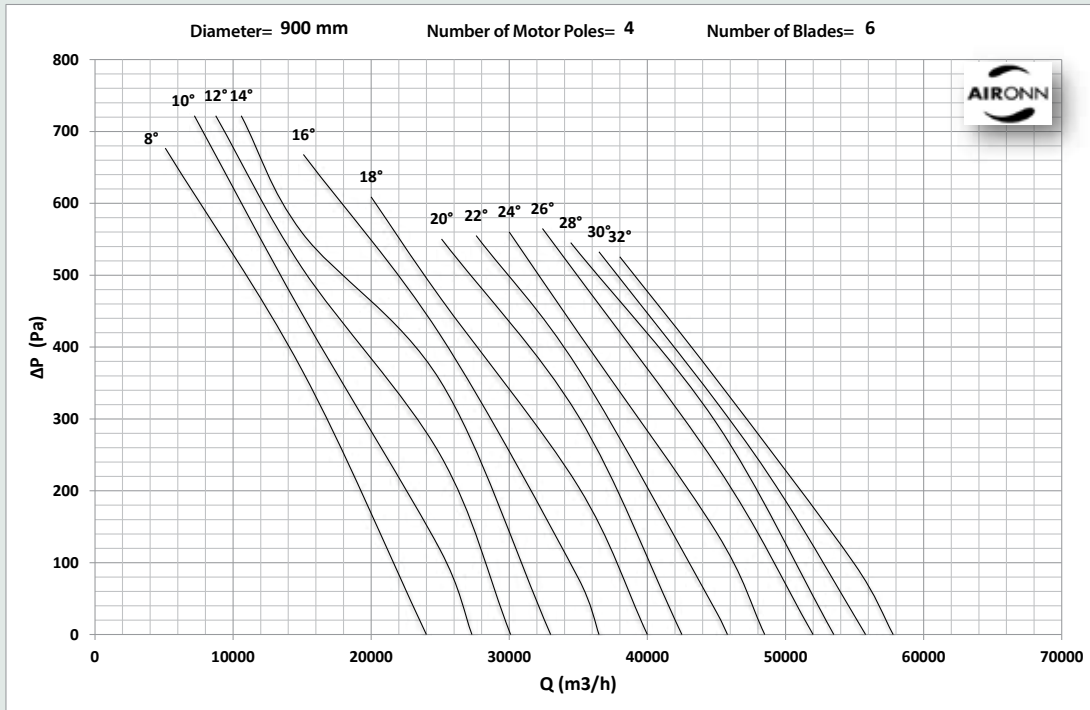

## Axial Type Silencer Body Fresh Air Fan

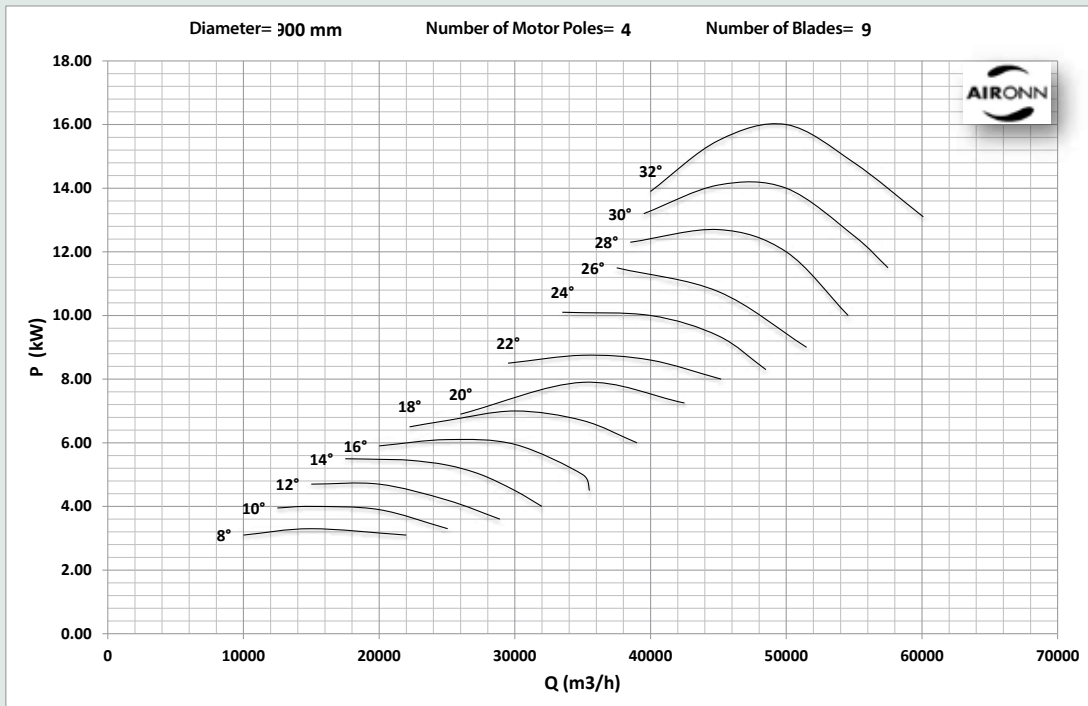
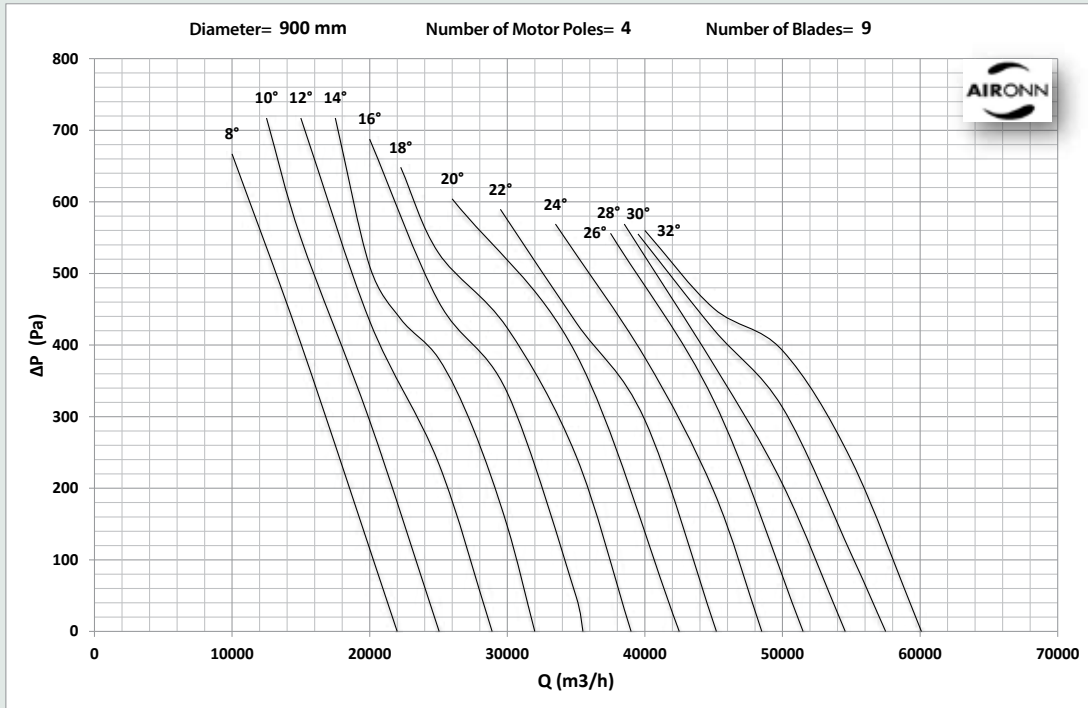

## Axial Type Silencer Body Fresh Air Fan

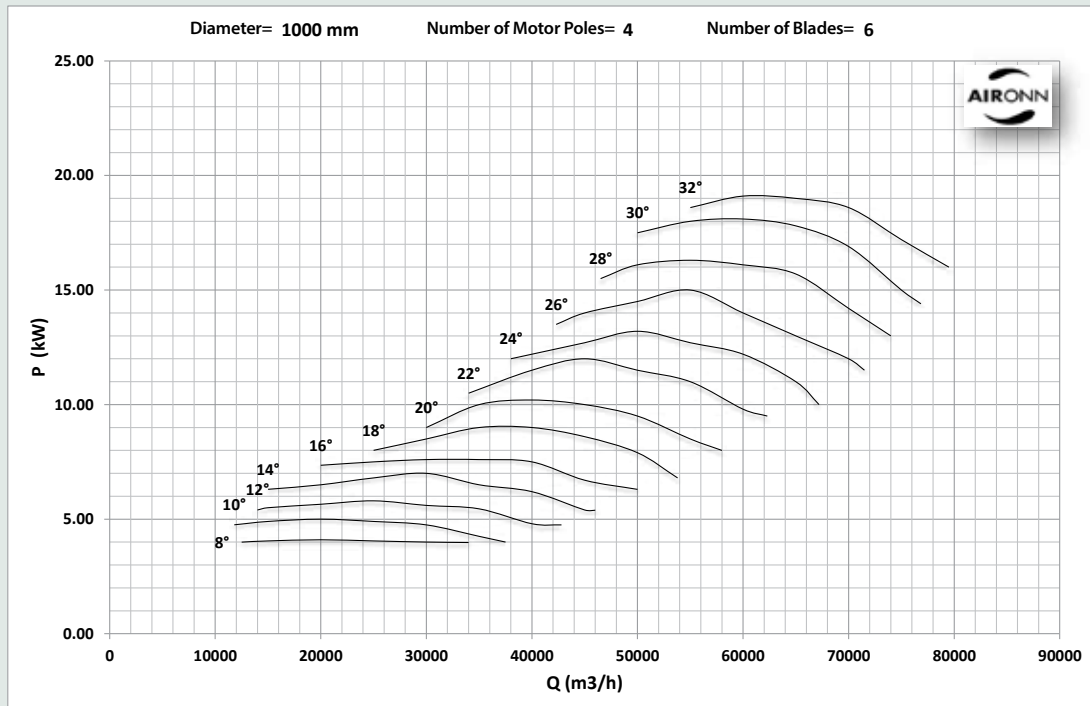
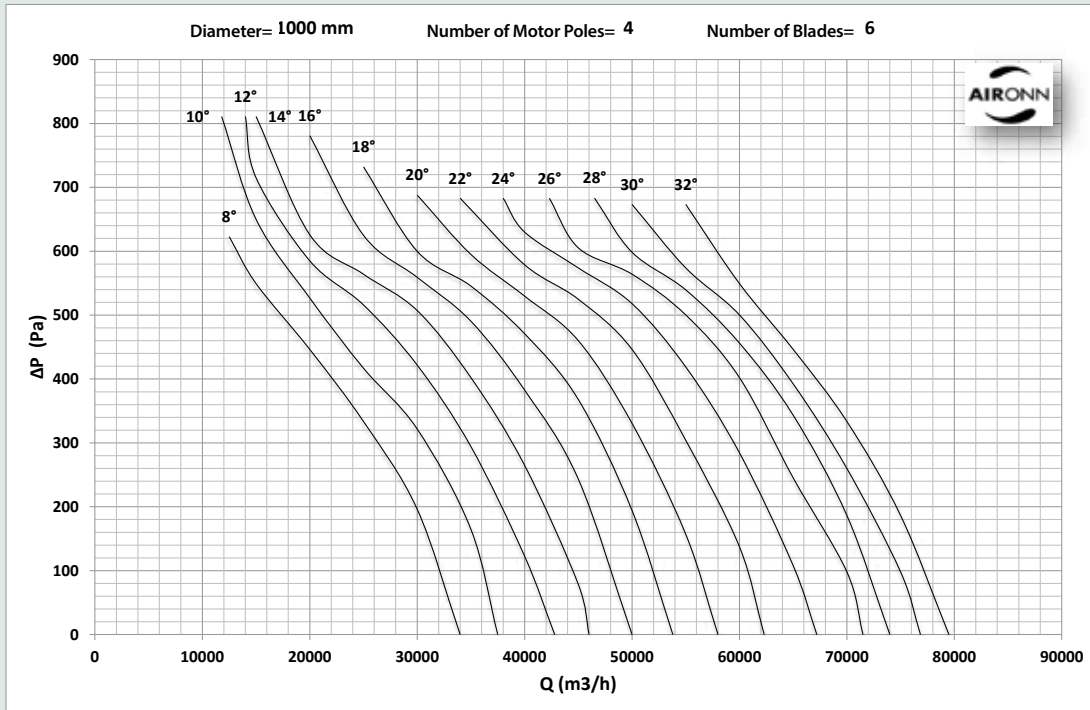



## Axial Type Silencer Body Fresh Air Fan

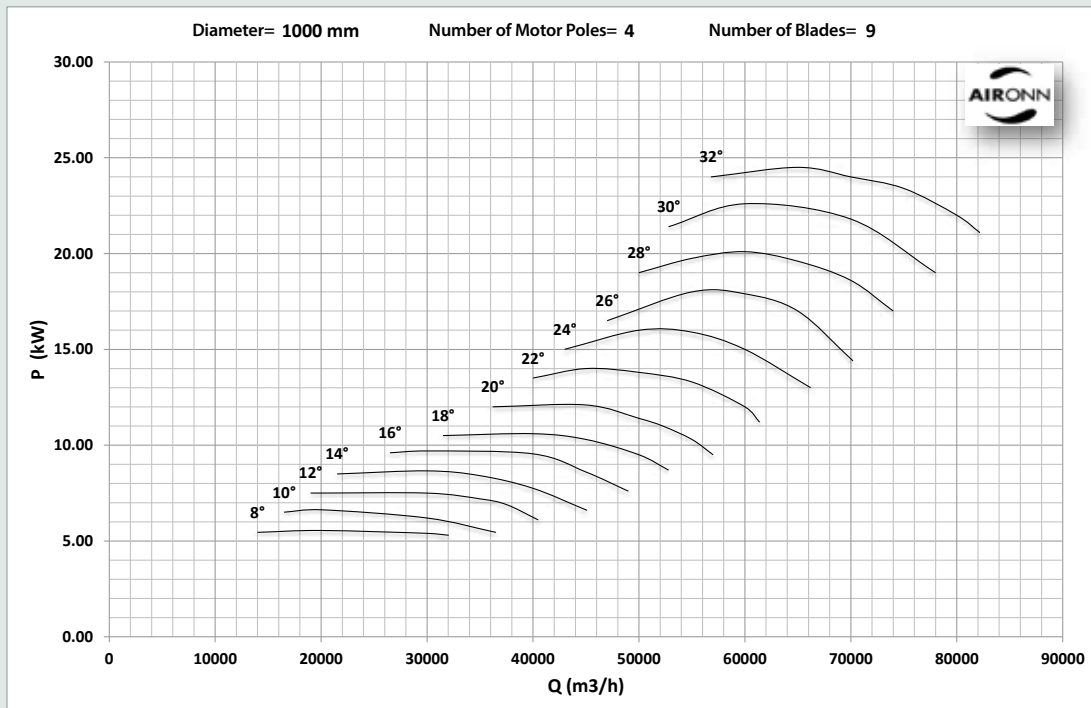
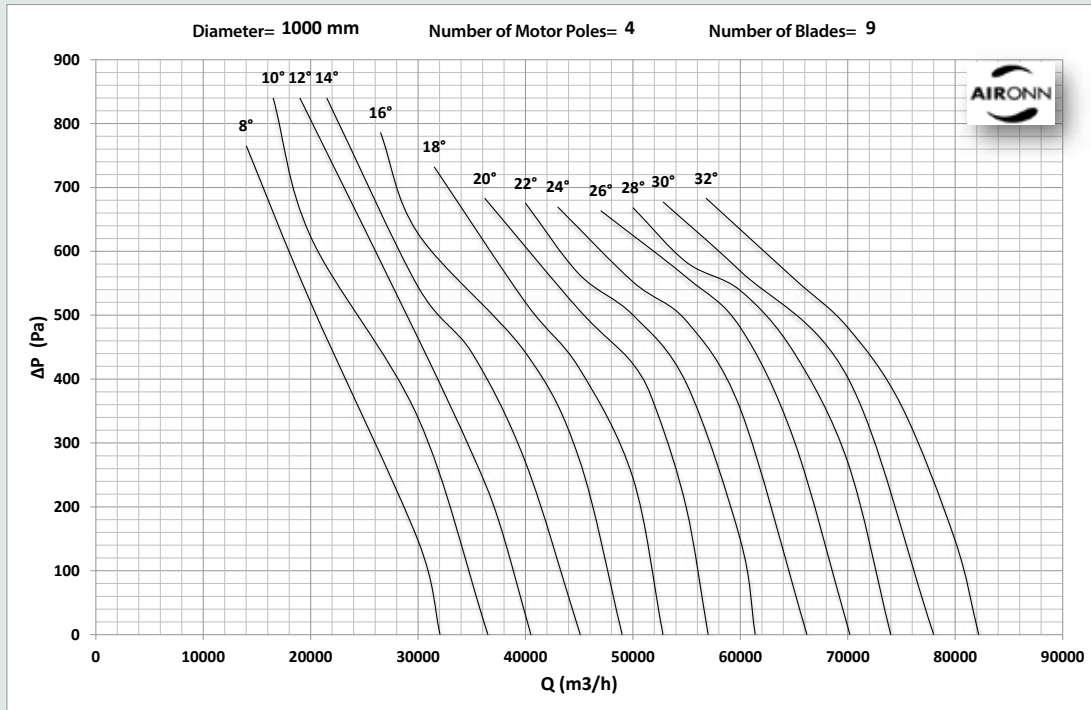

## Axial Type Silencer Body Fresh Air Fan

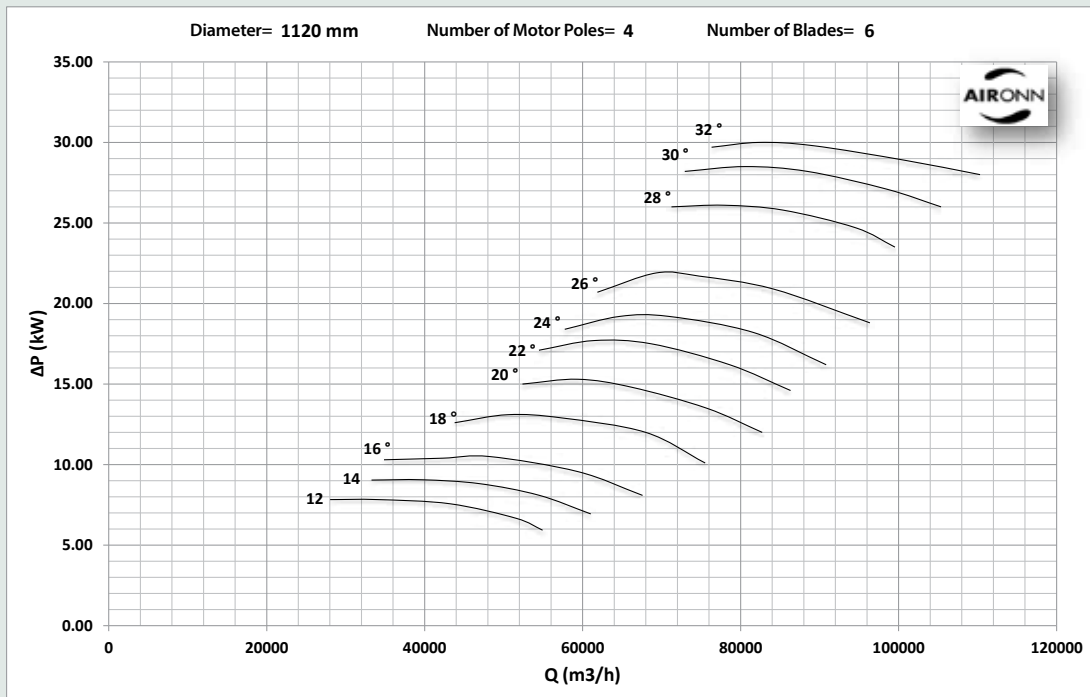
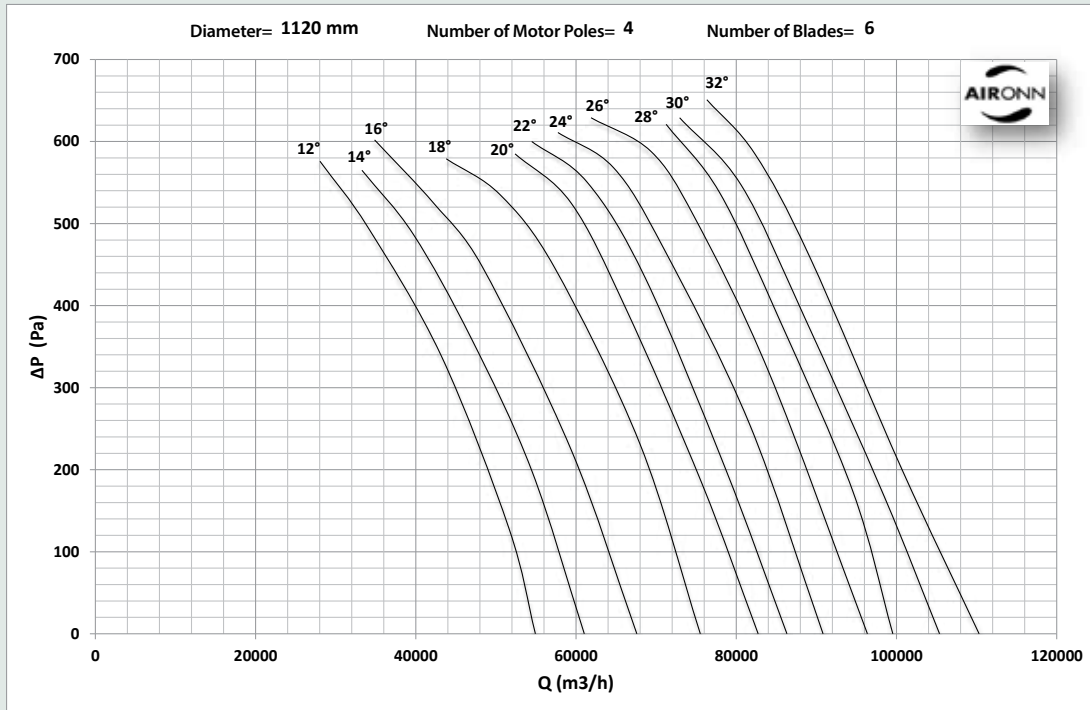

## Axial Type Silencer Body Fresh Air Fan

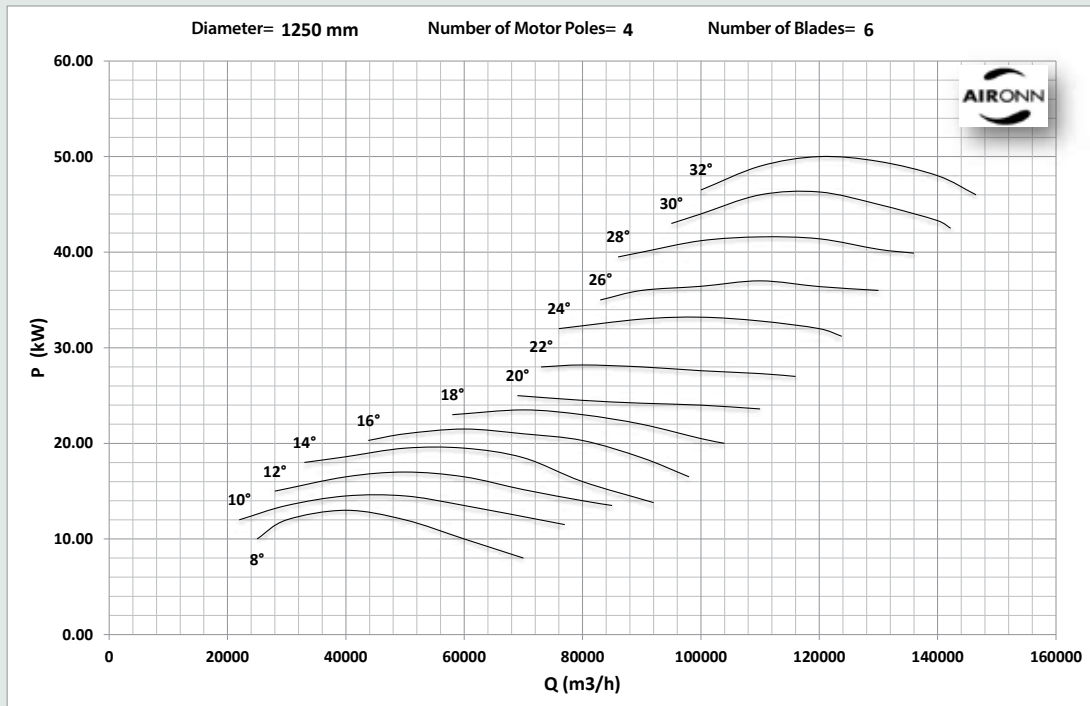
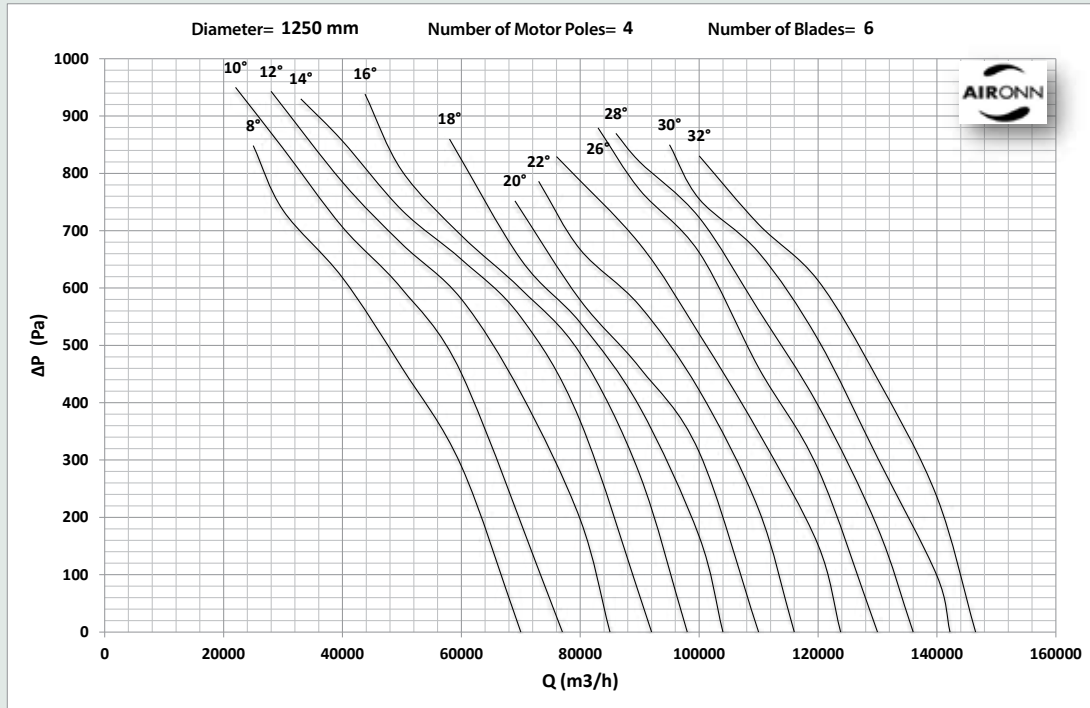

## Axial Type Silencer Body Fresh Air Fan

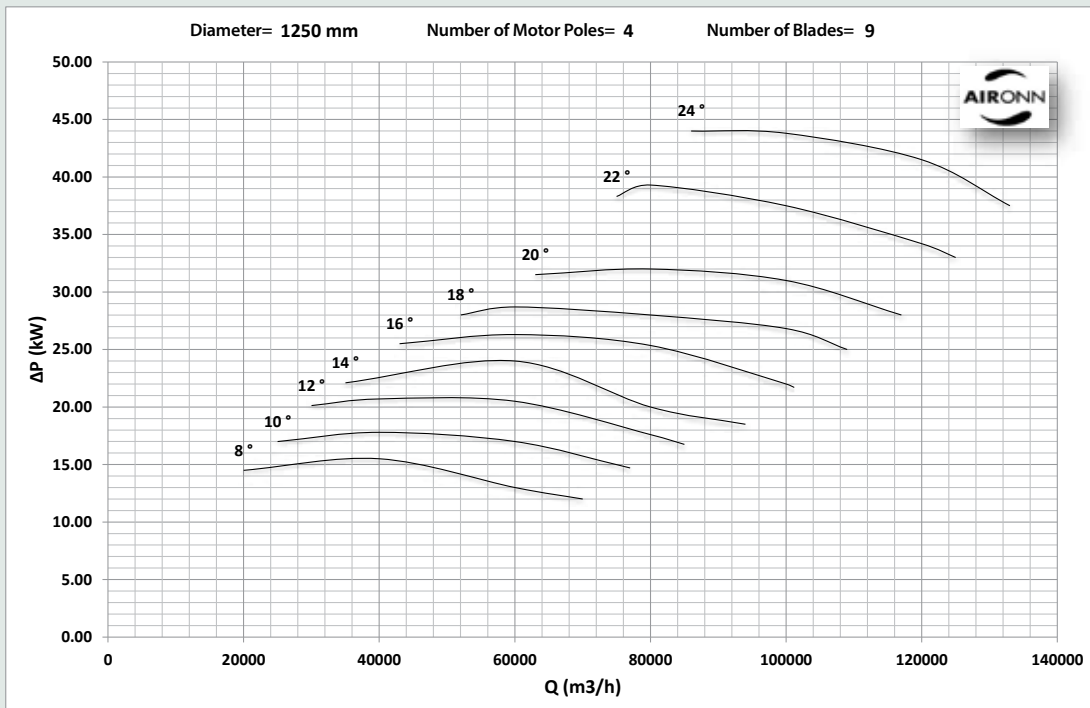
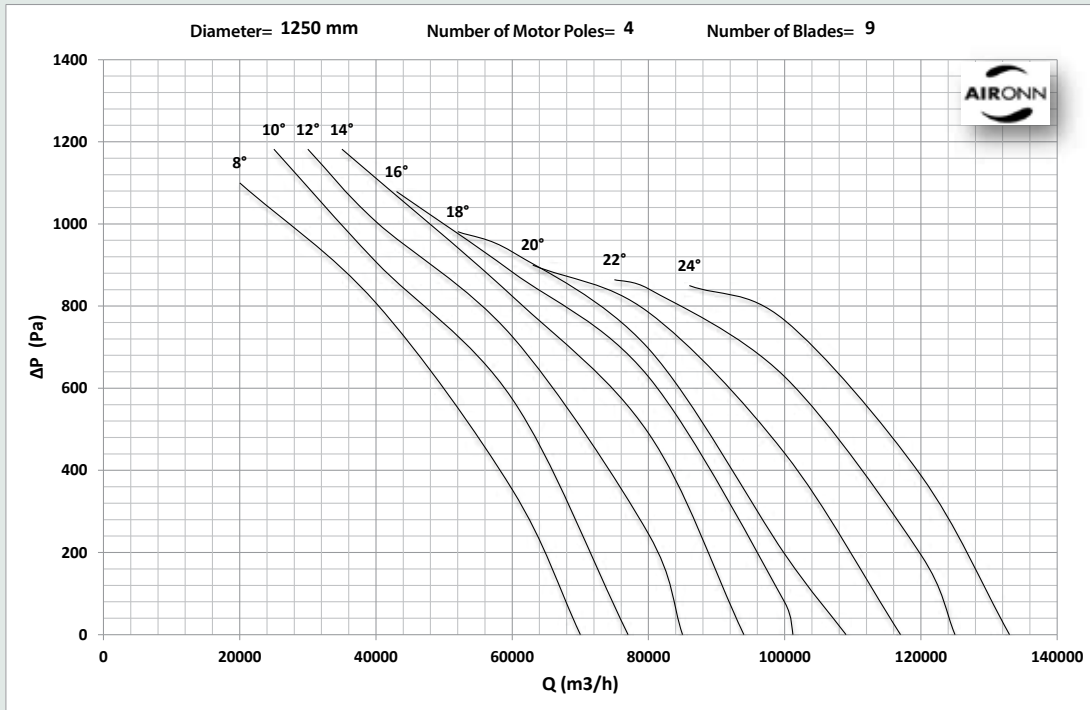

# Axial Type Silencer Body Smoke Exhaust Fan

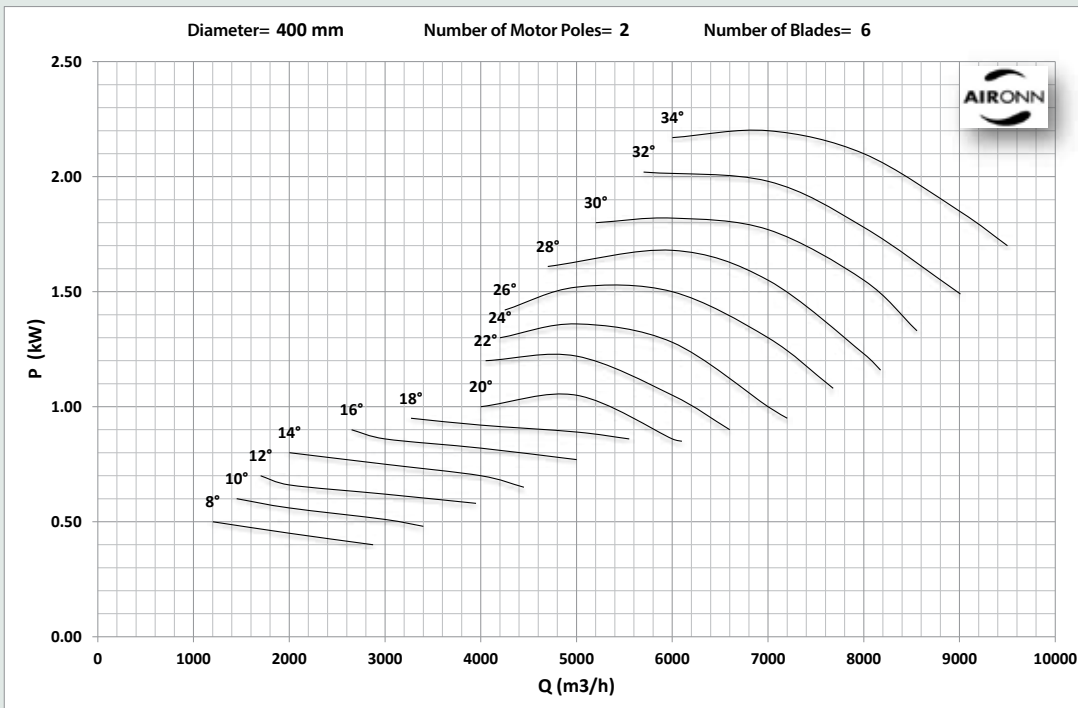
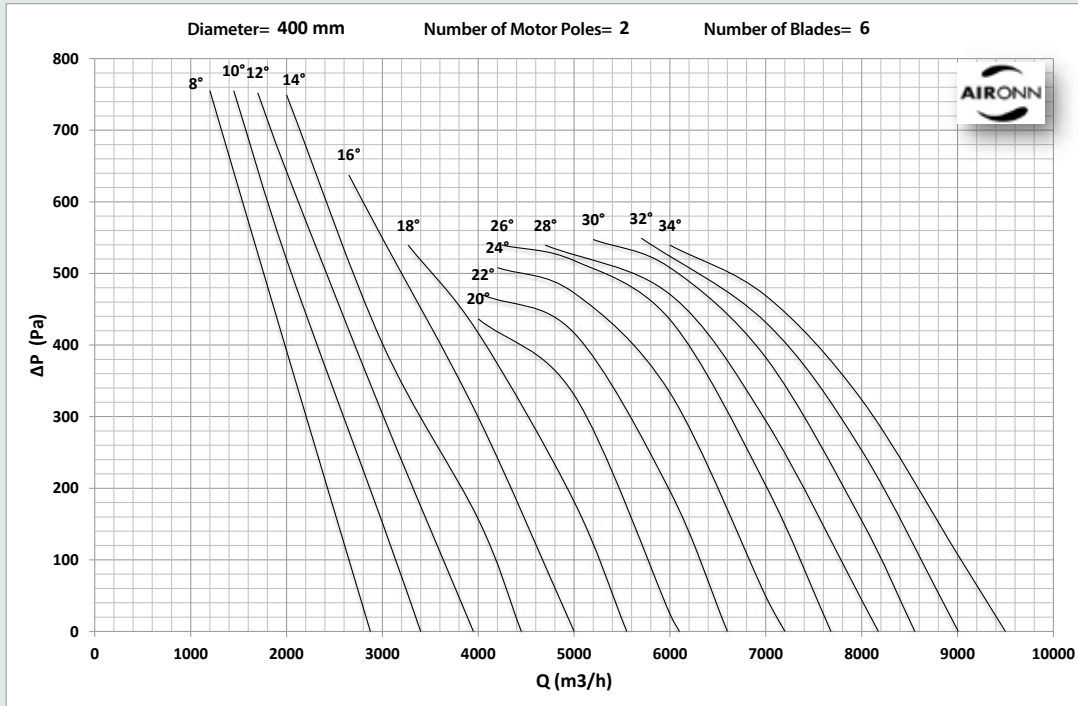

# Axial Type Silencer Body Smoke Exhaust Fan

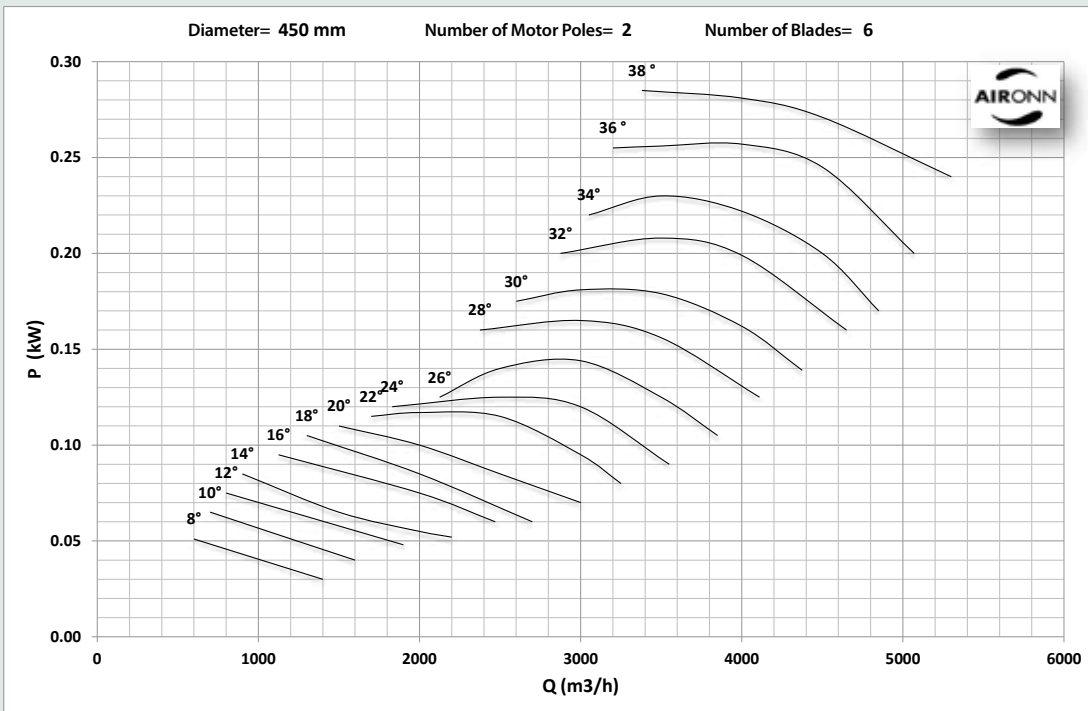
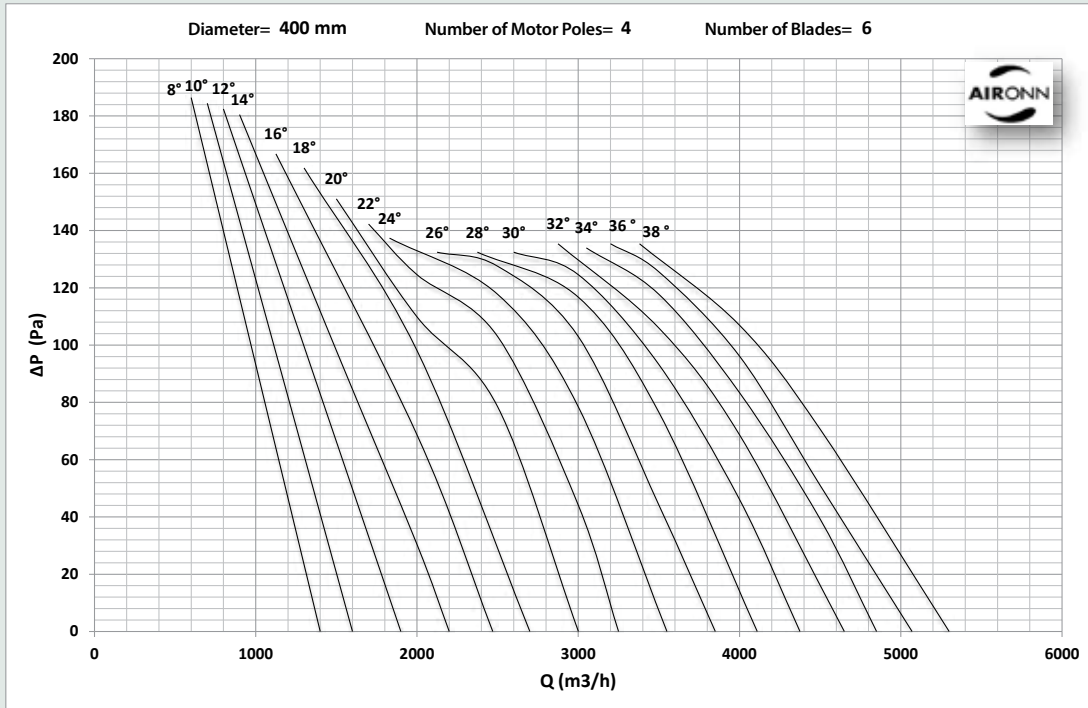

# Axial Type Silencer Body Smoke Exhaust Fan

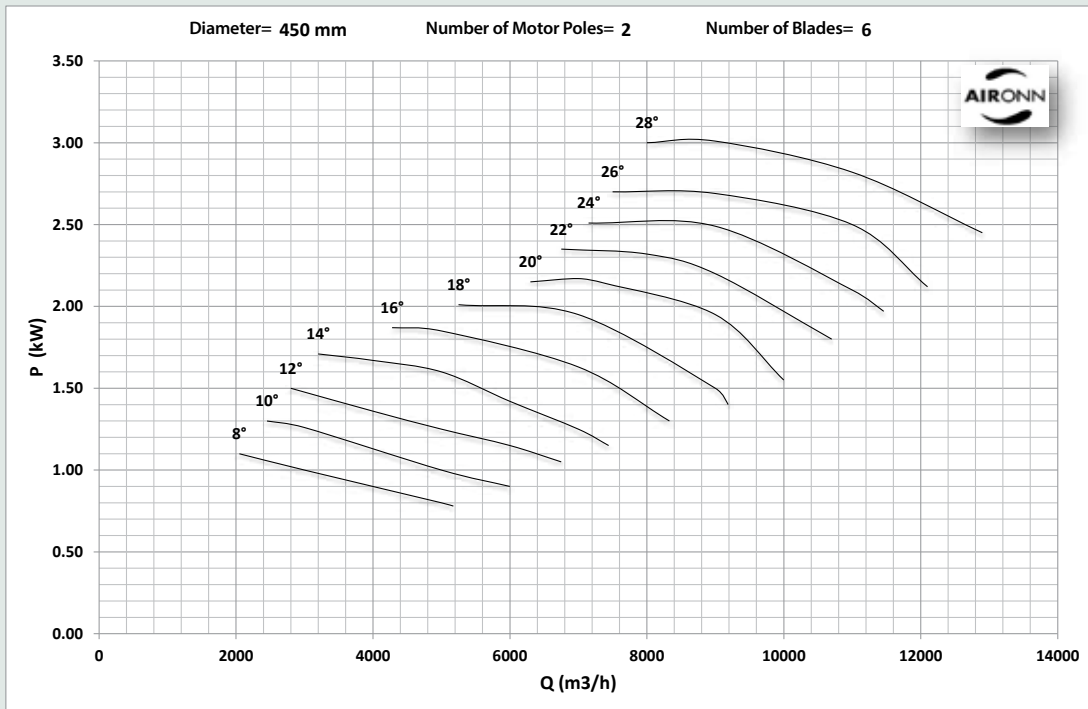
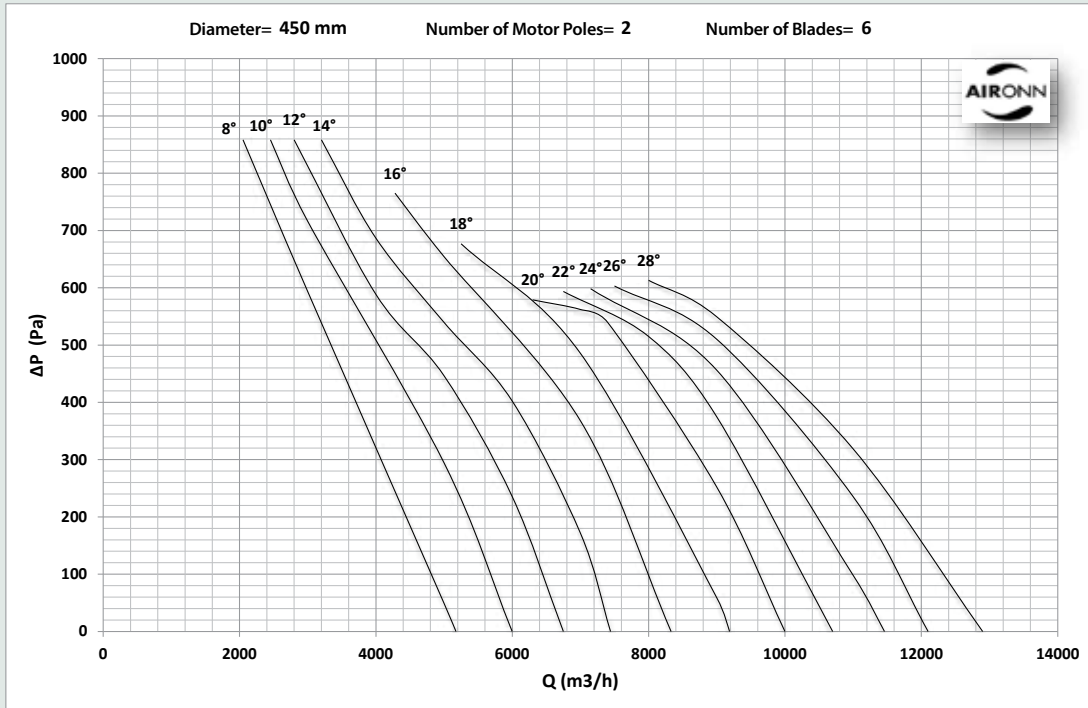

# Axial Type Silencer Body Smoke Exhaust Fan

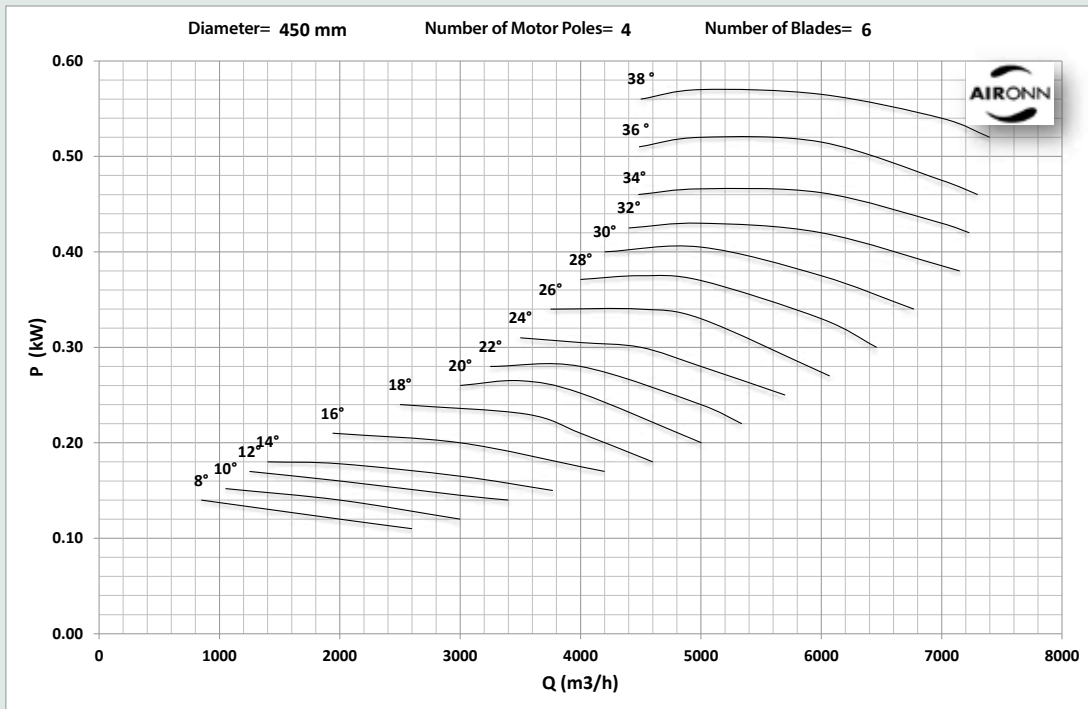
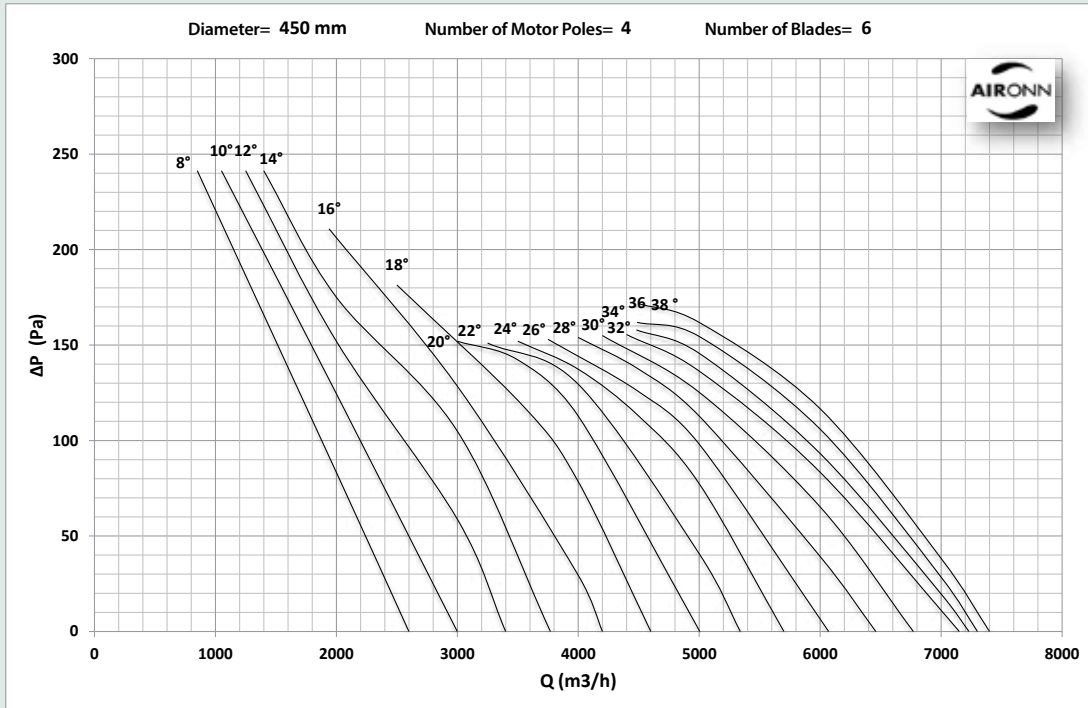



# Axial Type Silencer Body Smoke Exhaust Fan

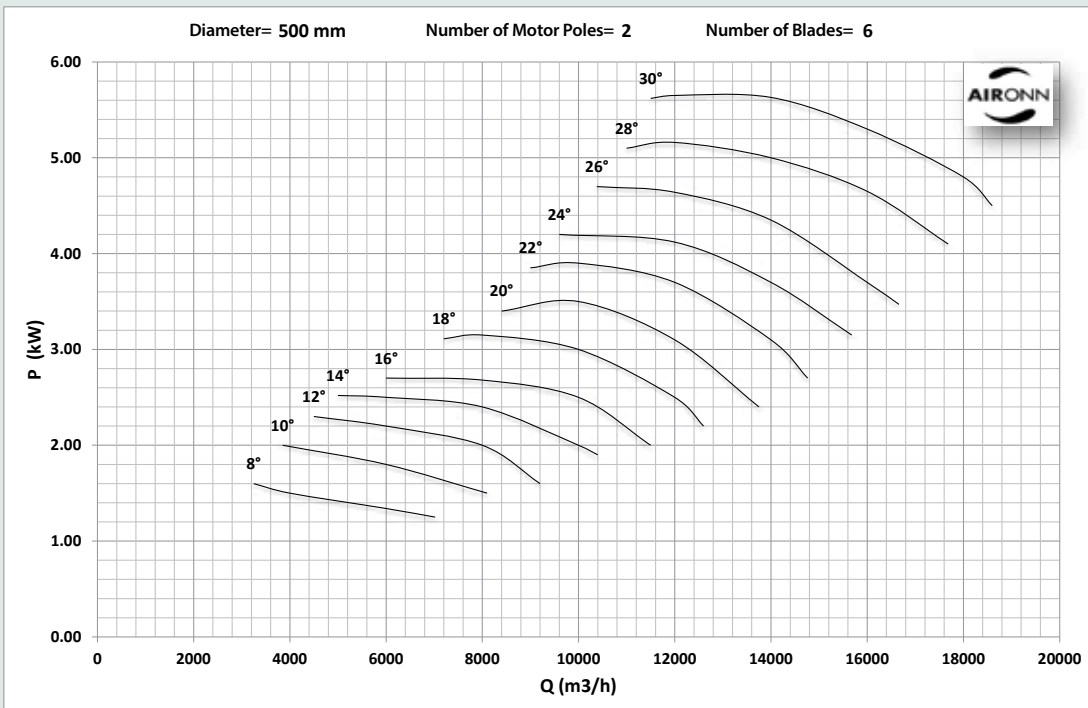
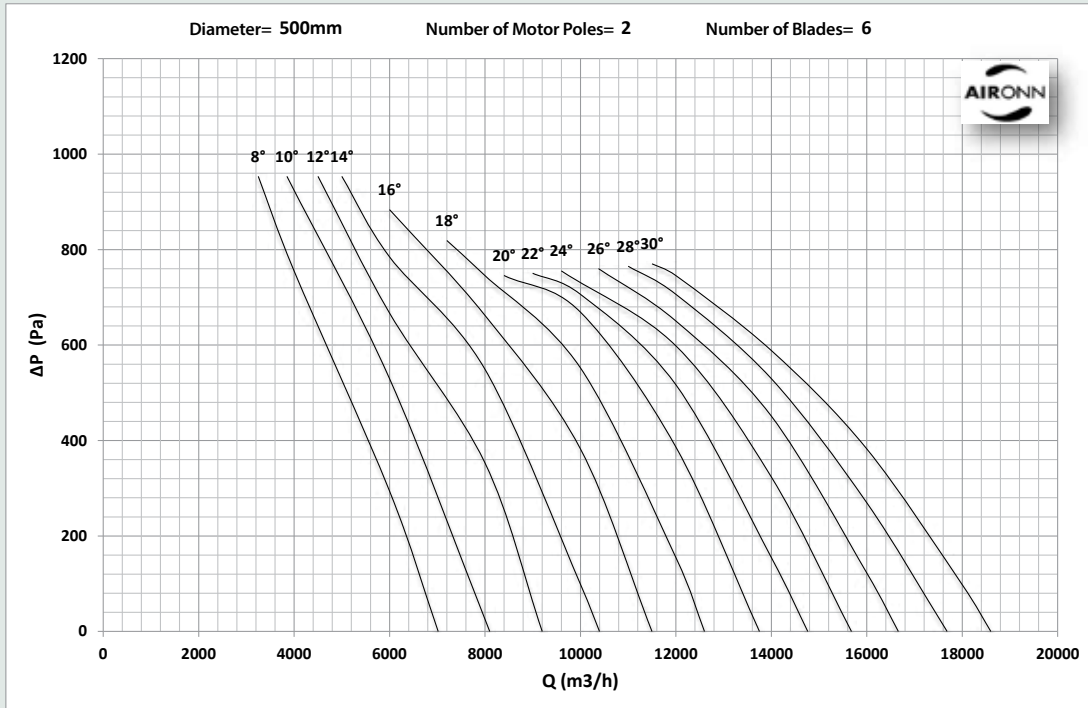

# Axial Type Silencer Body Smoke Exhaust Fan

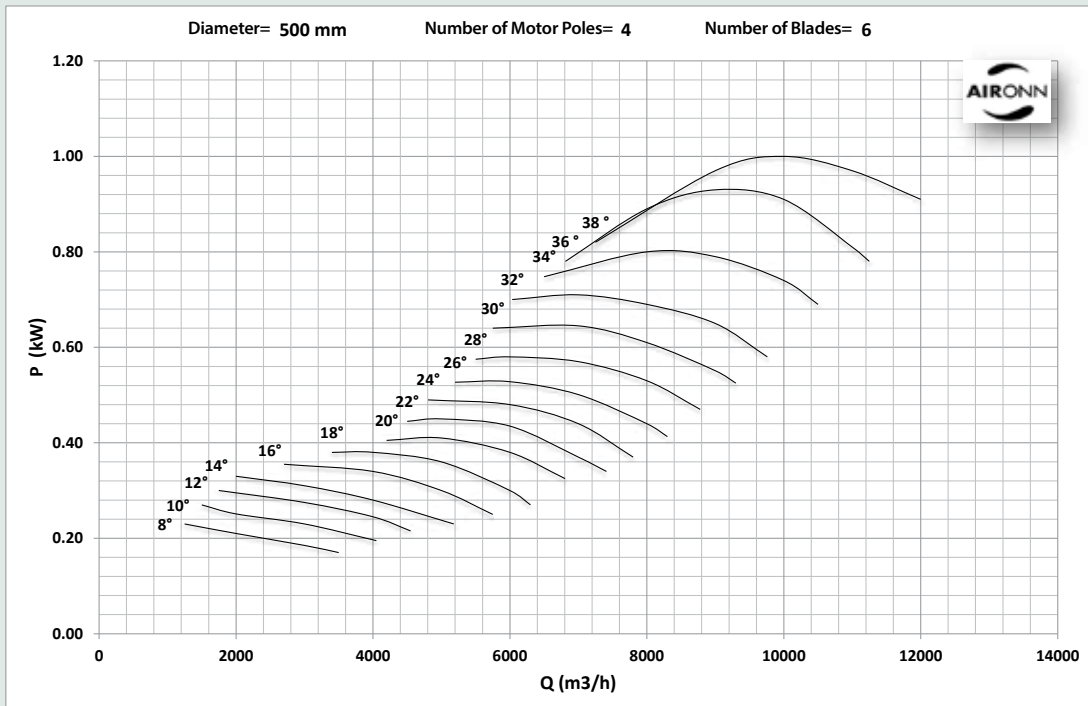
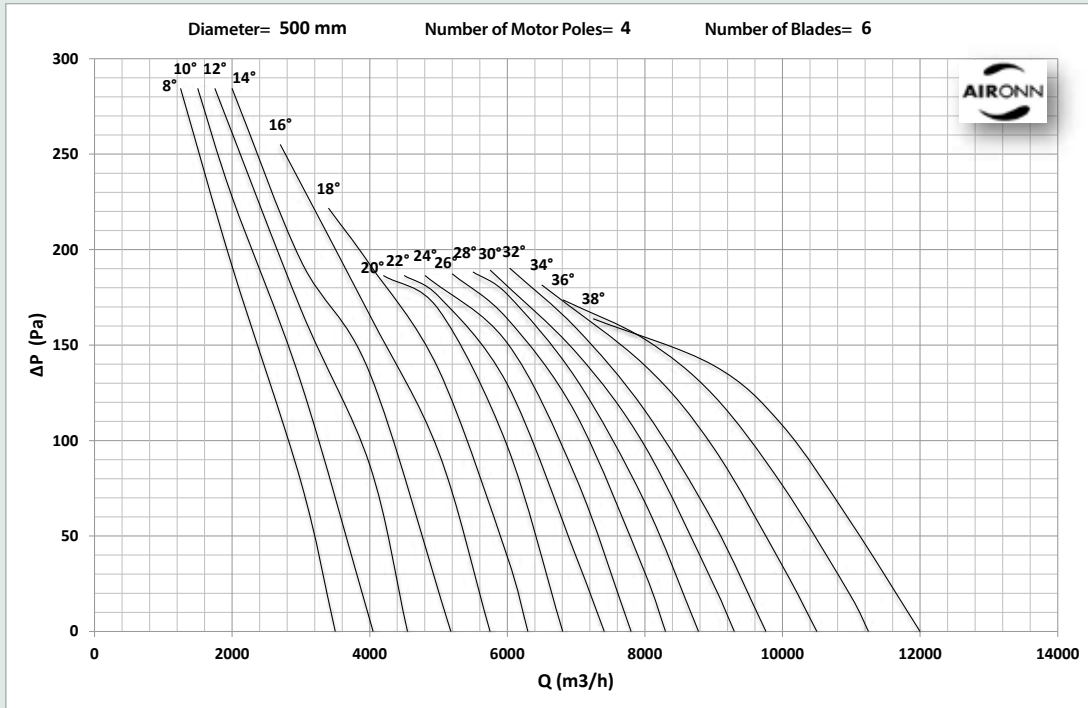

# Axial Type Silencer Body Smoke Exhaust Fan

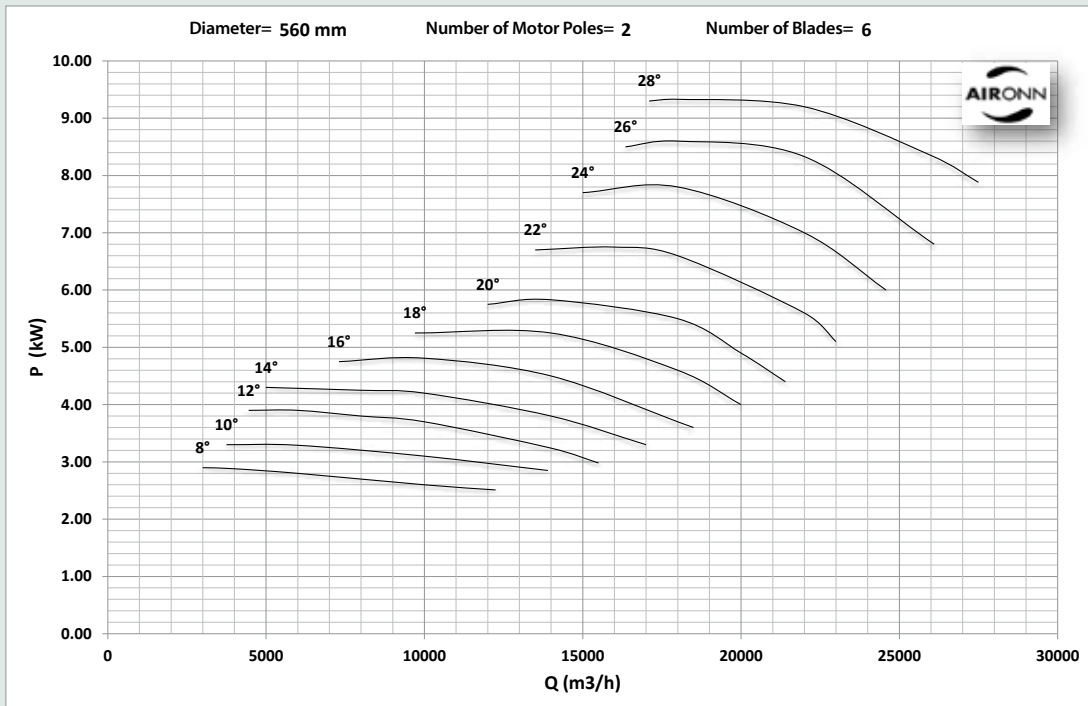
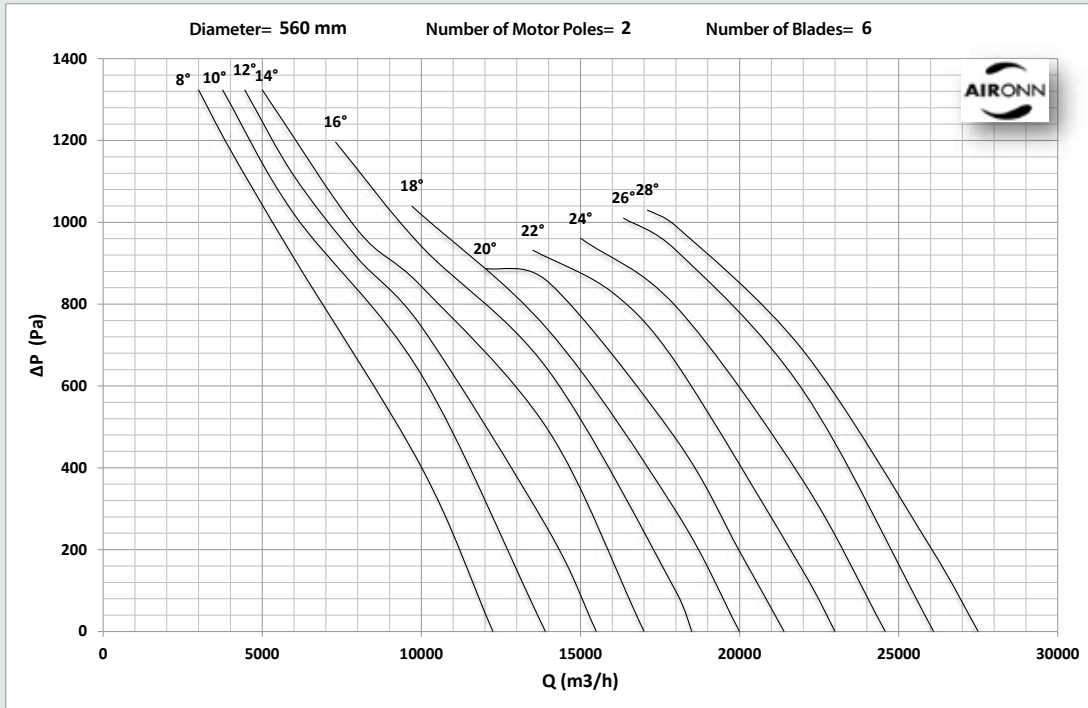

# Axial Type Silencer Body Smoke Exhaust Fan

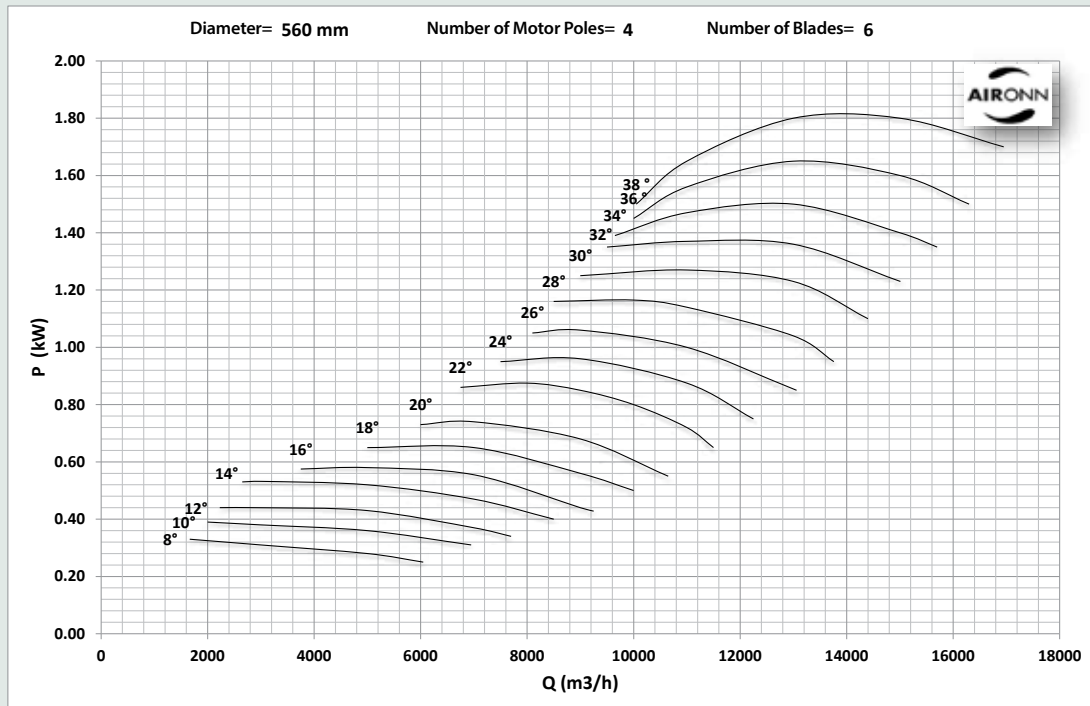
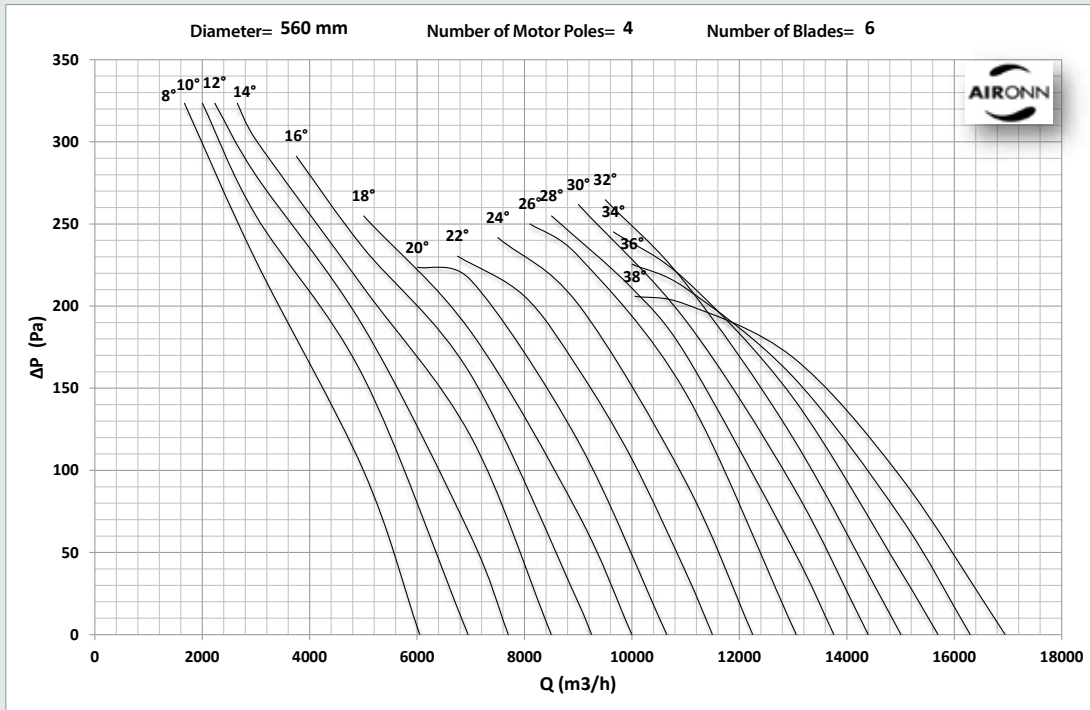

# Axial Type Silencer Body Smoke Exhaust Fan

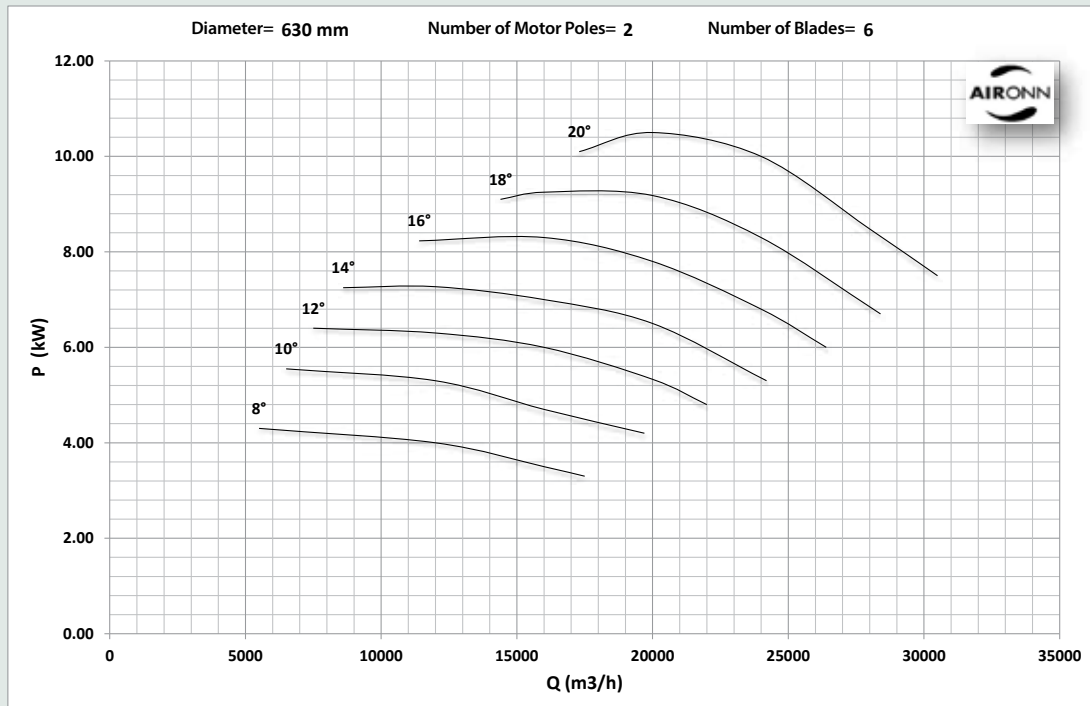
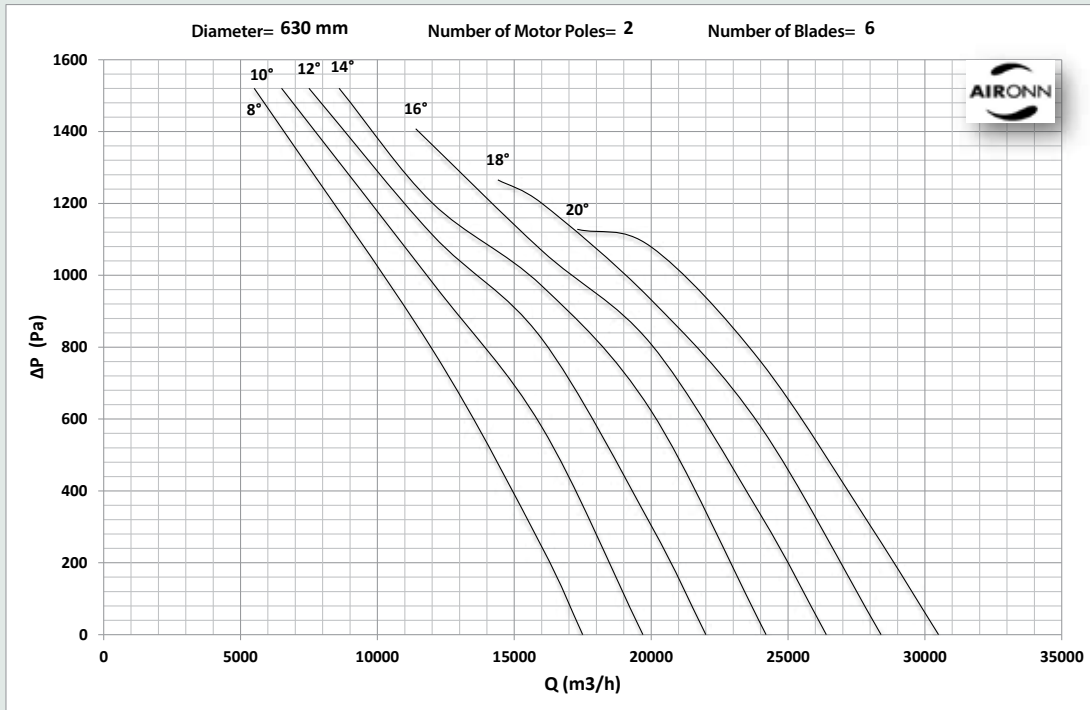

# Axial Type Silencer Body Smoke Exhaust Fan

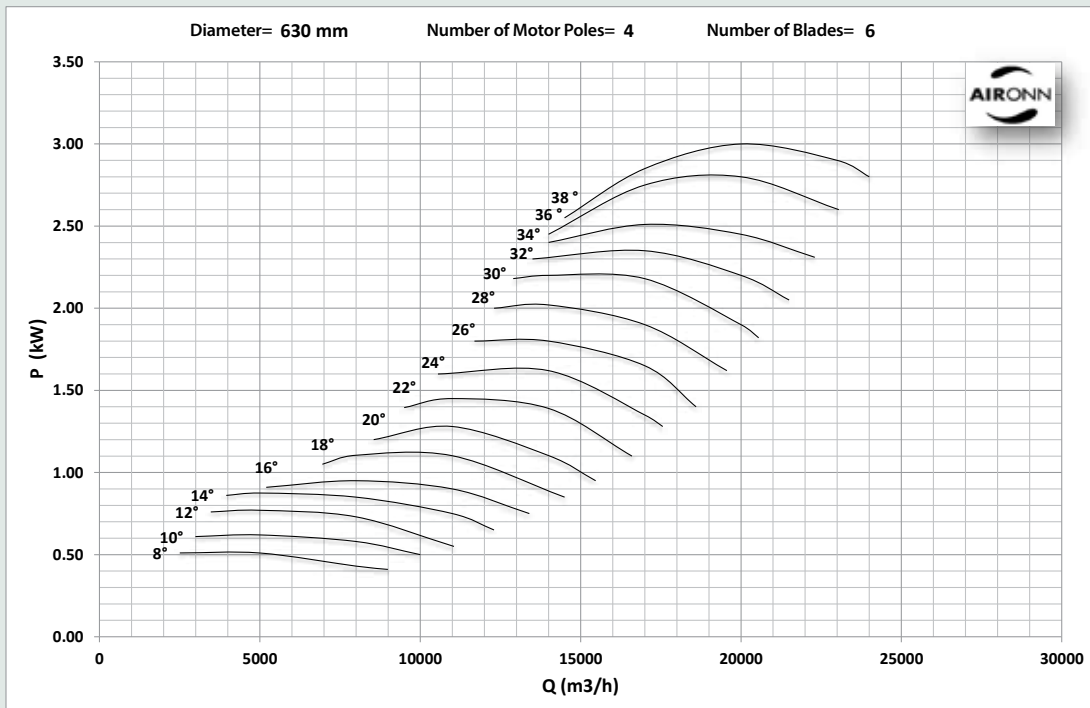
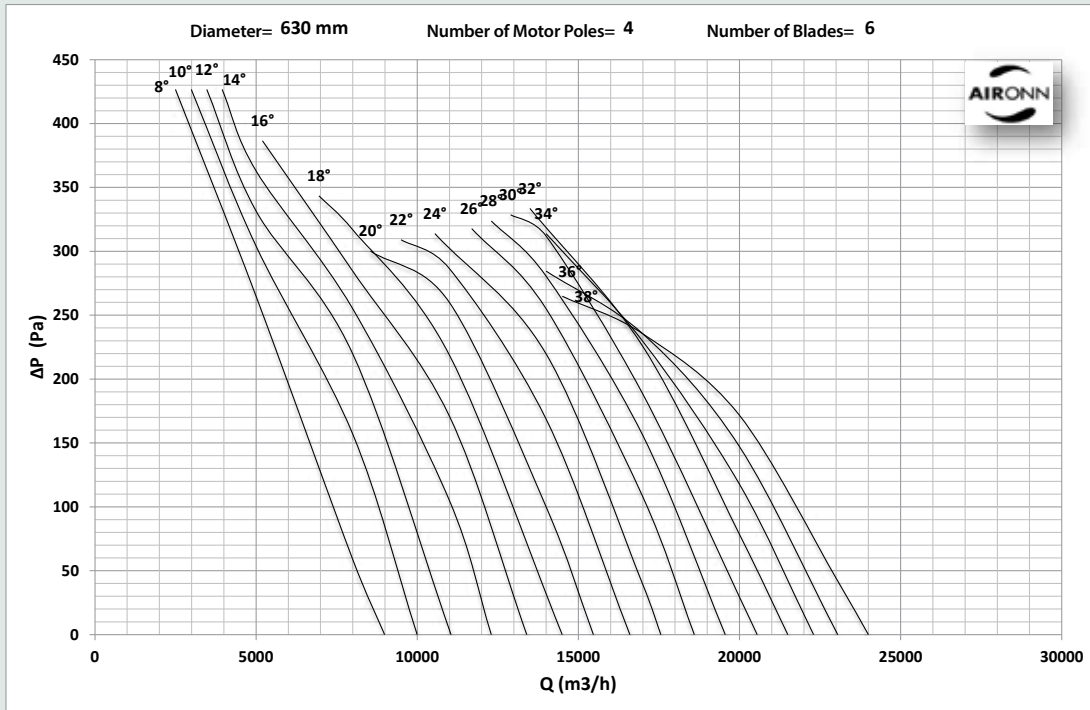

# Axial Type Silencer Body Smoke Exhaust Fan

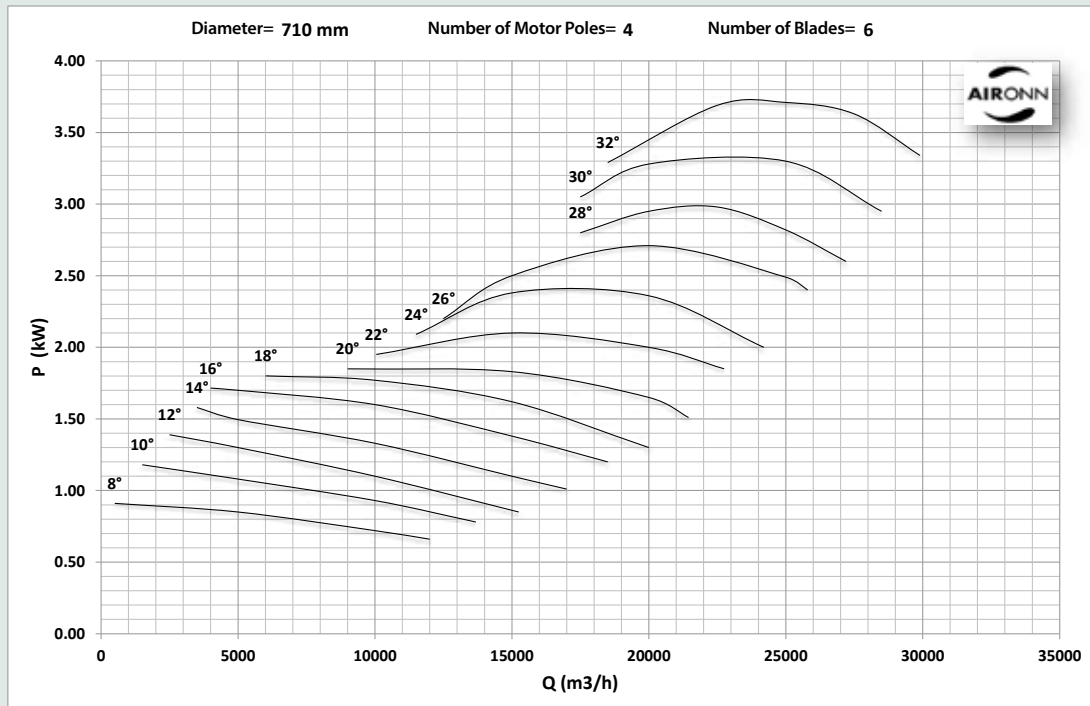
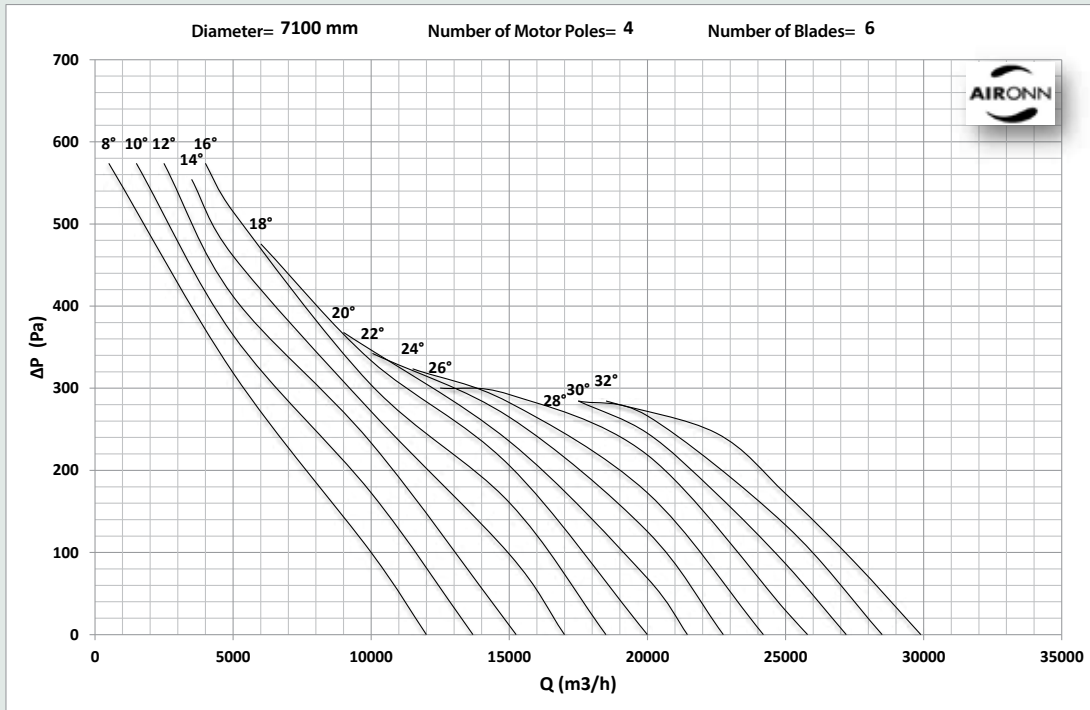

# Axial Type Silencer Body Smoke Exhaust Fan

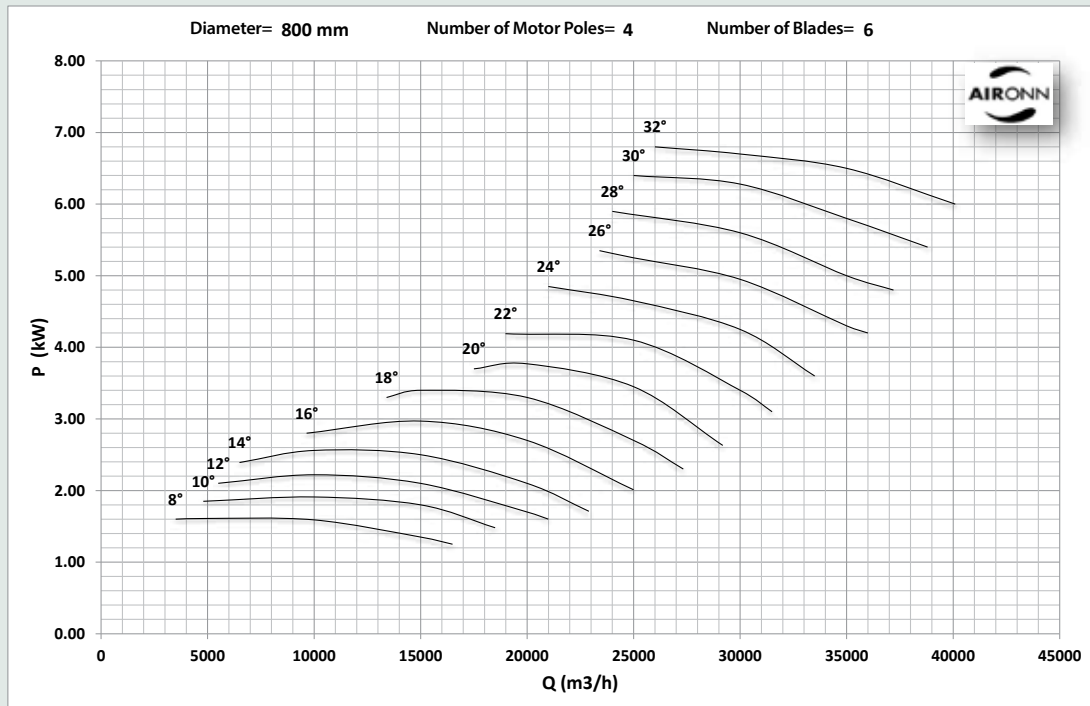
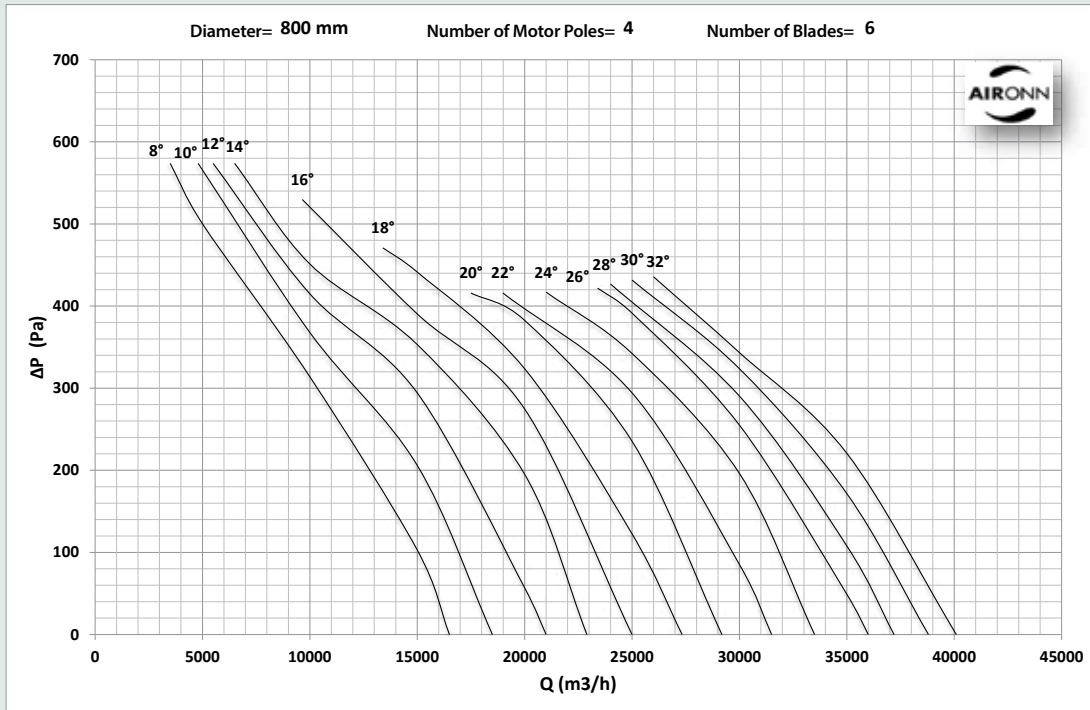



# Axial Type Silencer Body Smoke Exhaust Fan

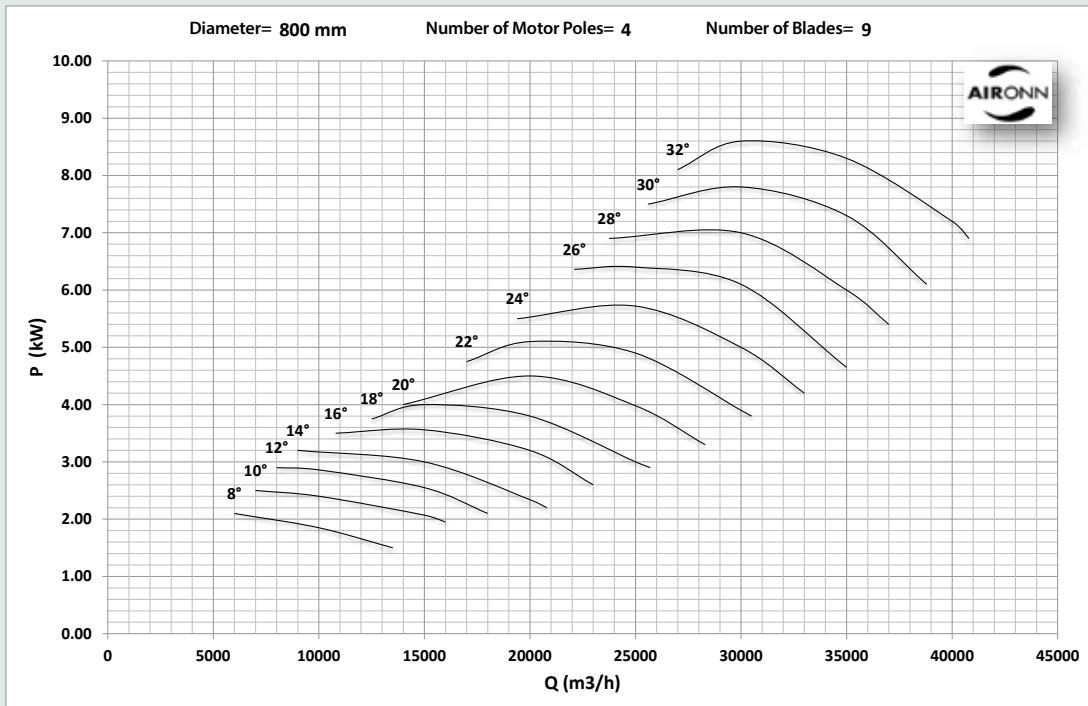
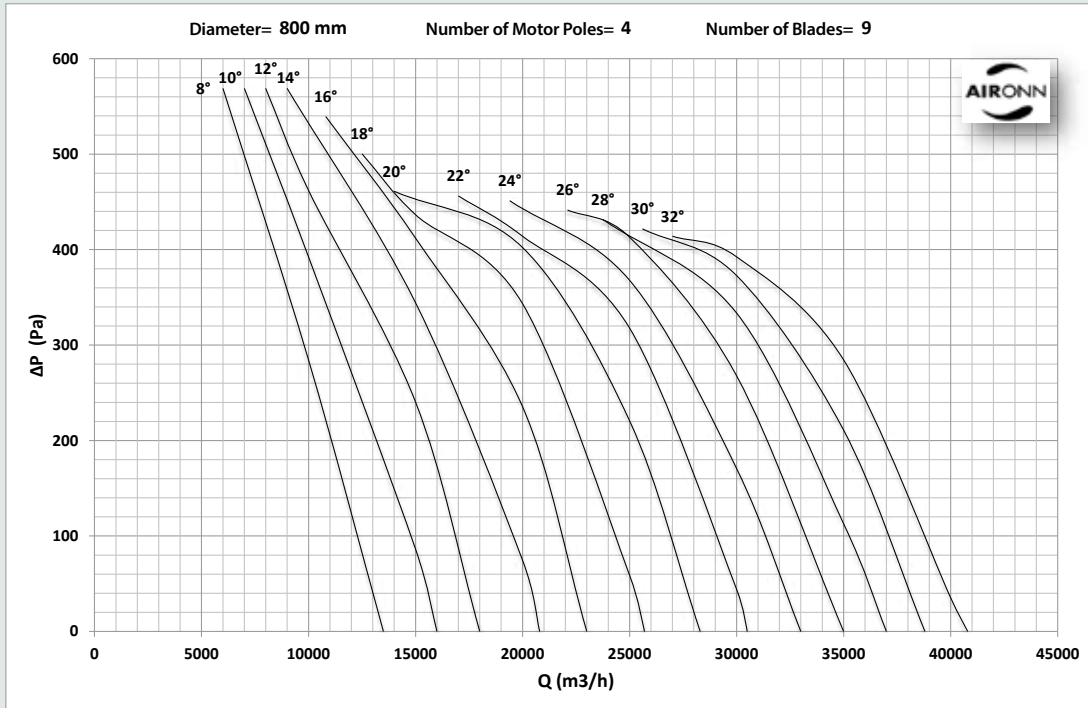

# Axial Type Silencer Body Smoke Exhaust Fan

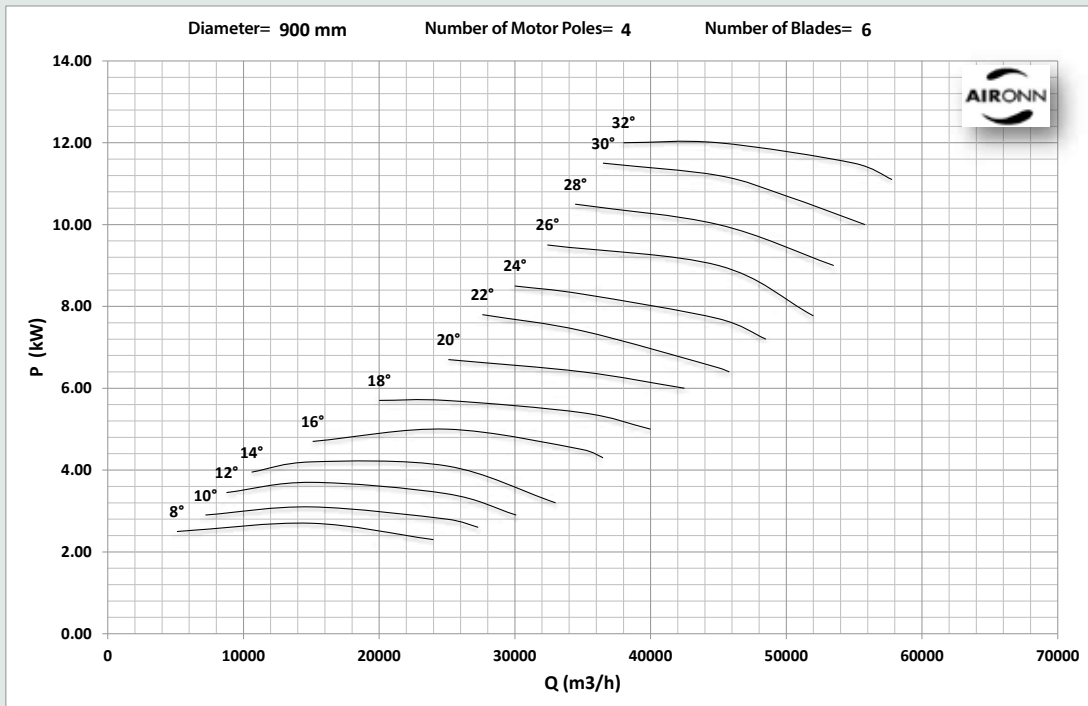
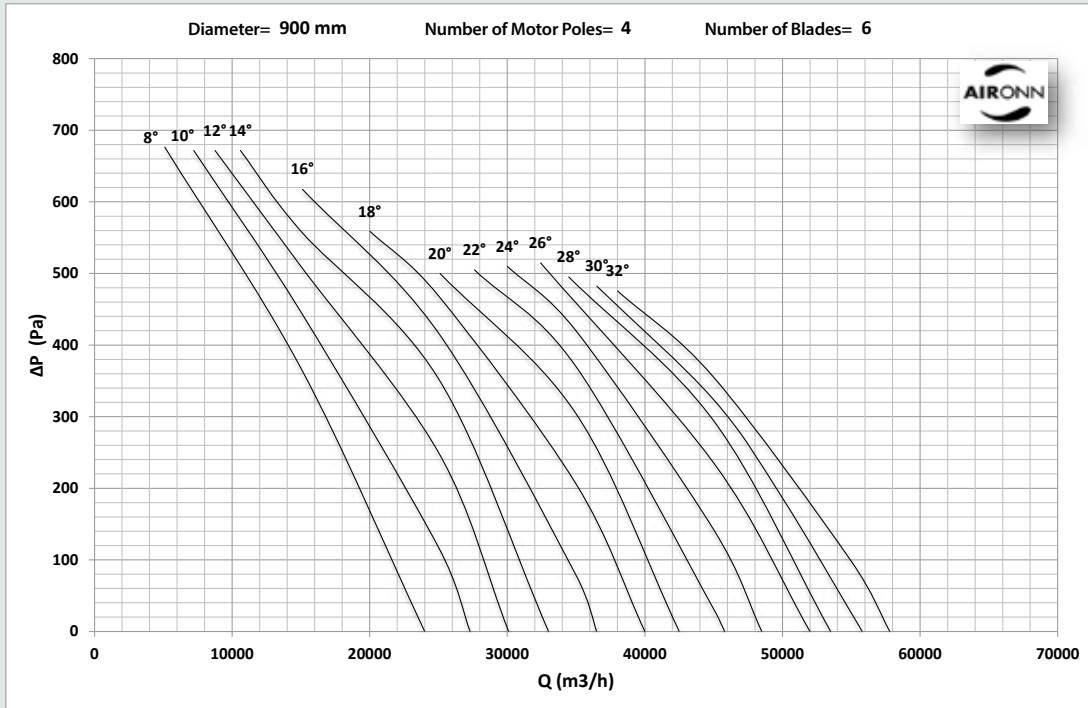

# Axial Type Silencer Body Smoke Exhaust Fan

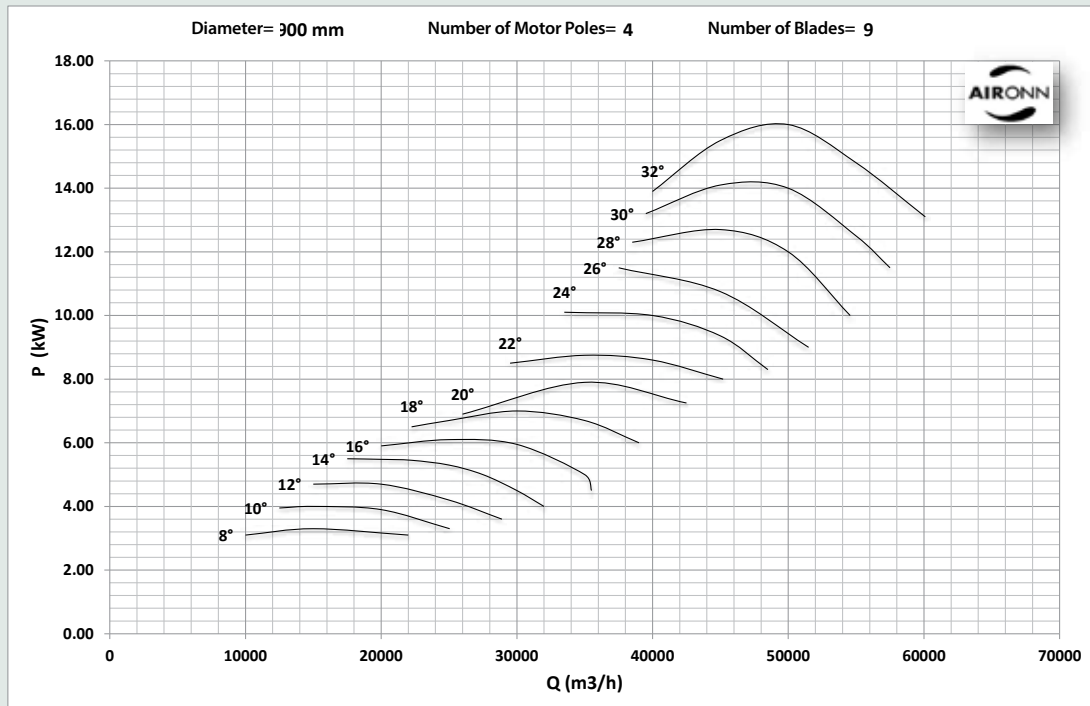
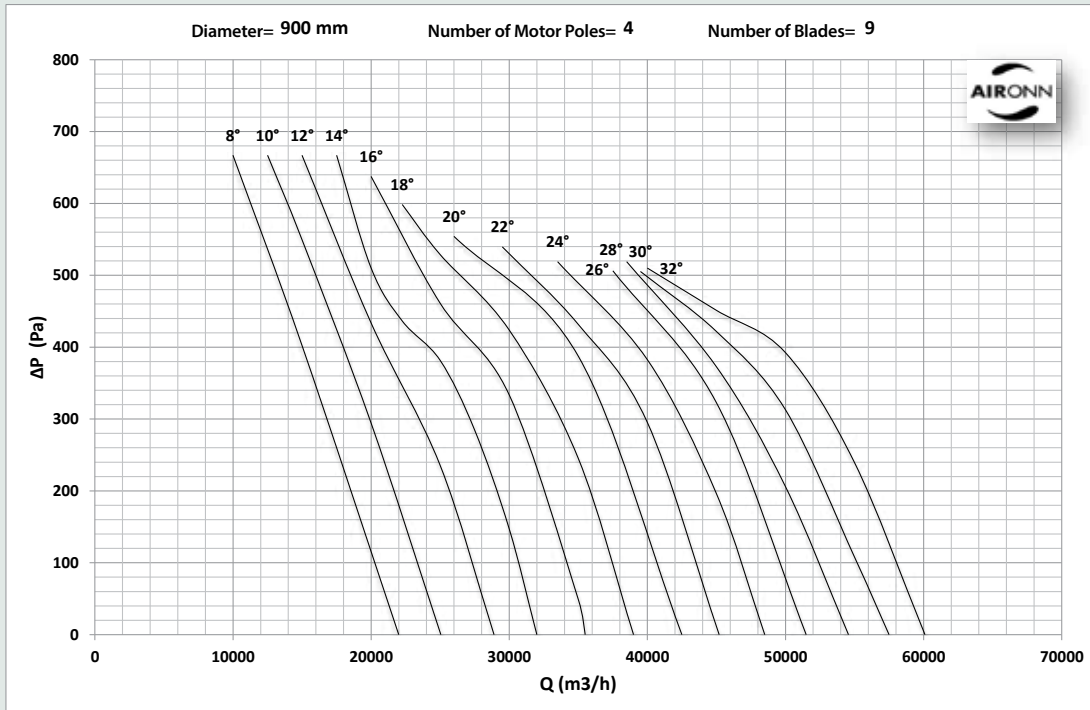

# Axial Type Silencer Body Smoke Exhaust Fan

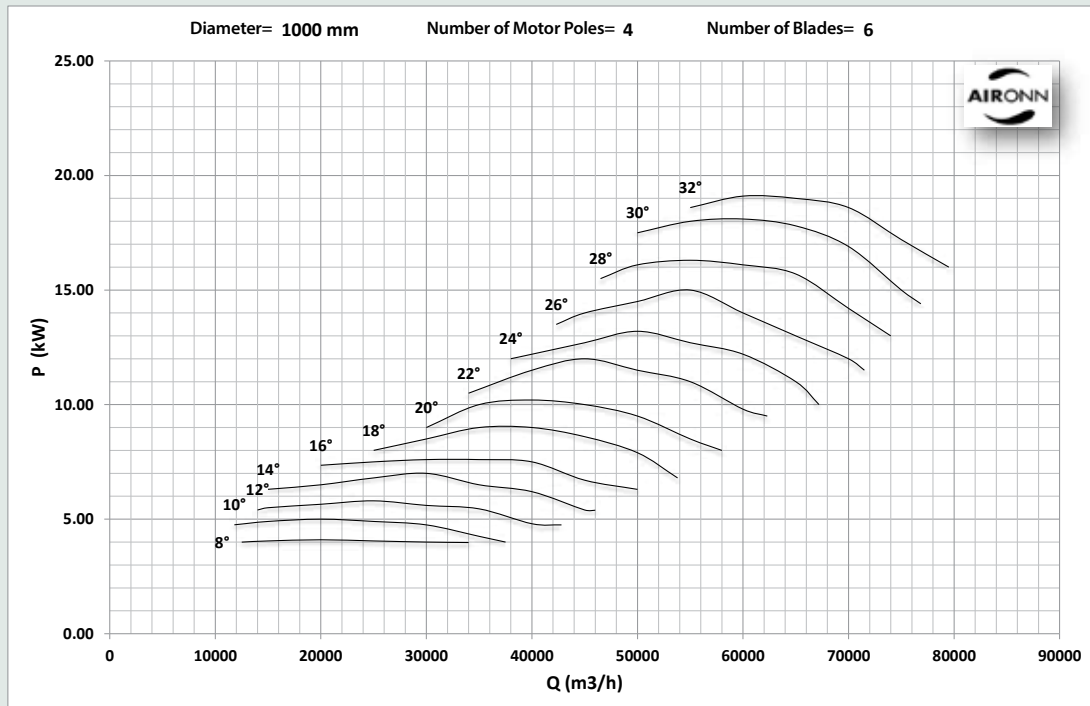
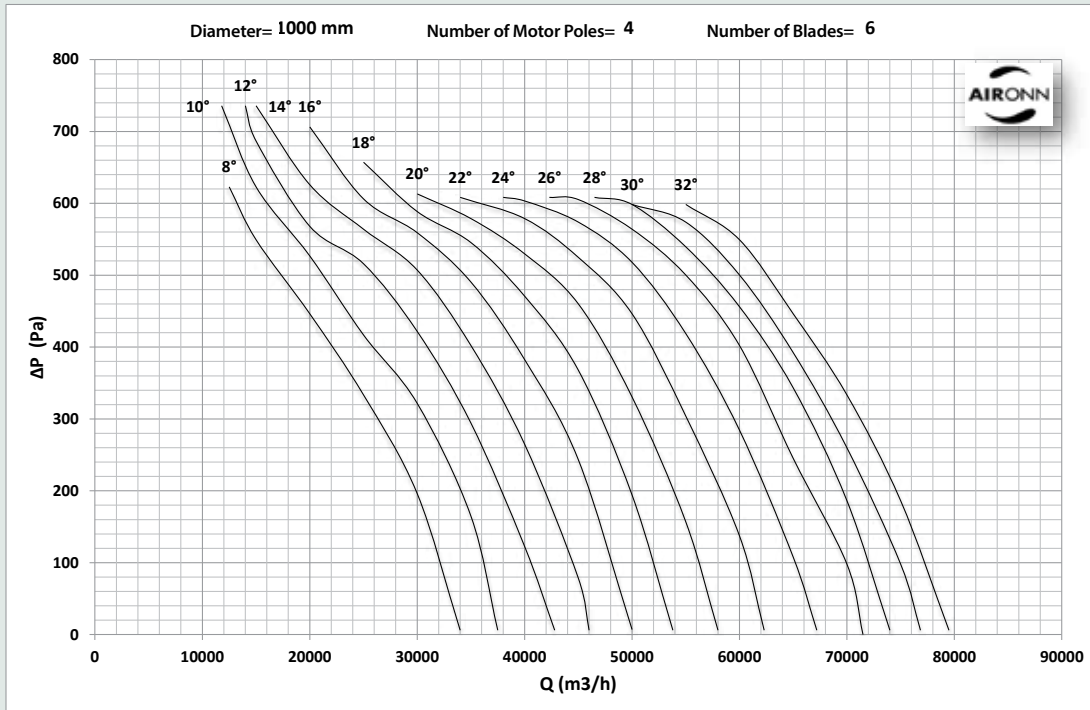

# Axial Type Silencer Body Smoke Exhaust Fan

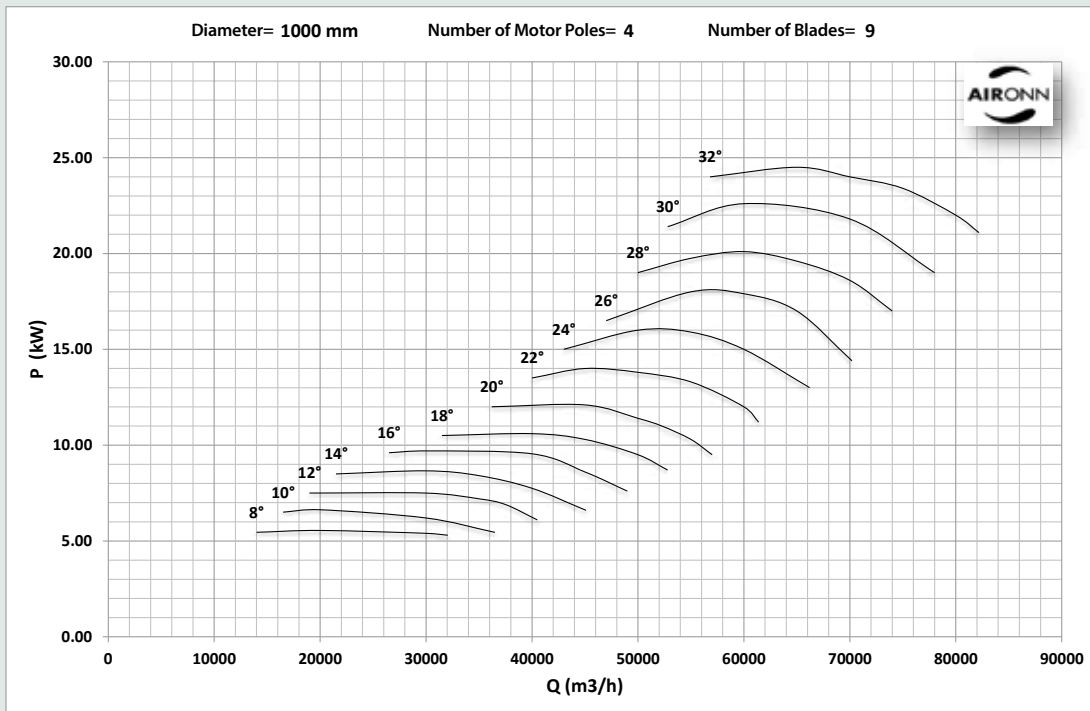
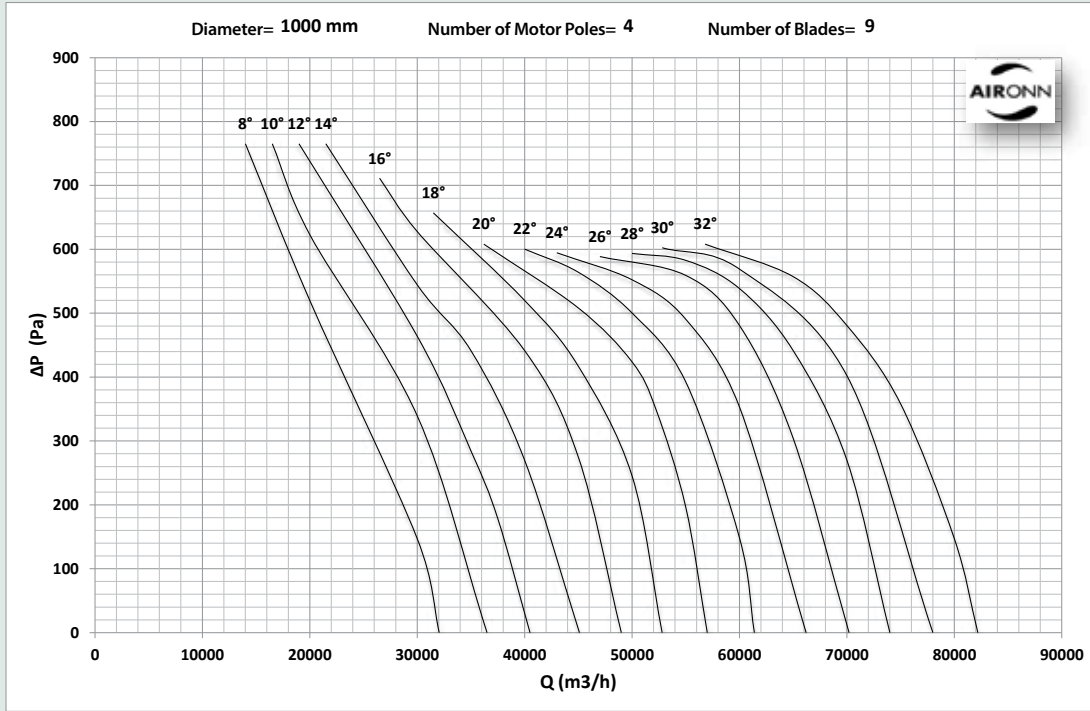

# Axial Type Silencer Body Smoke Exhaust Fan

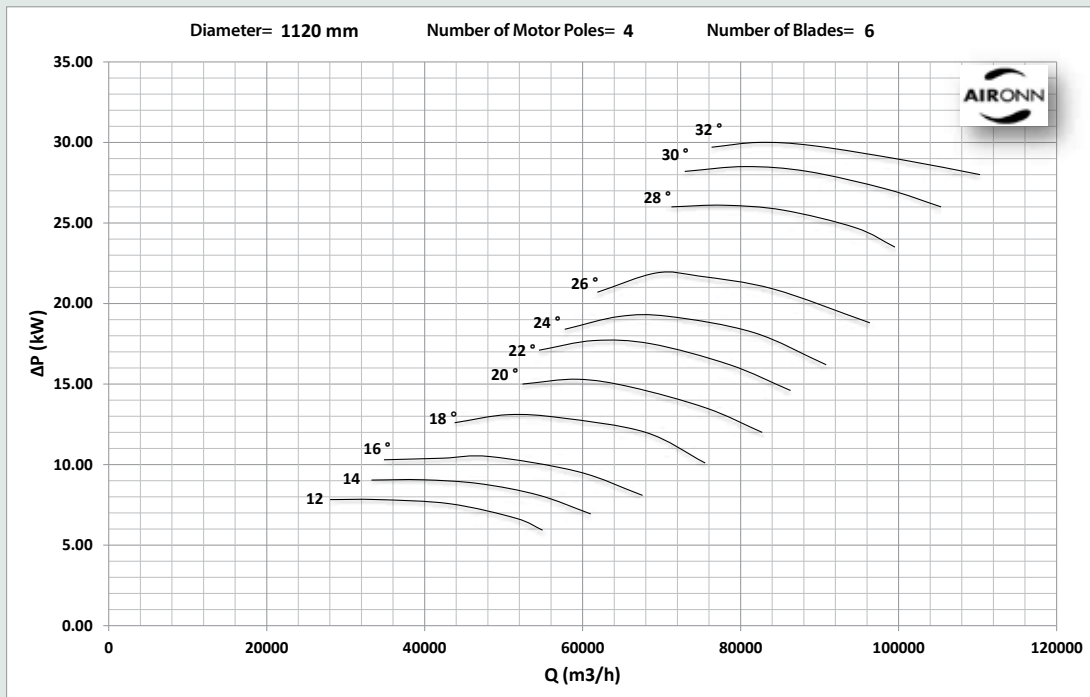
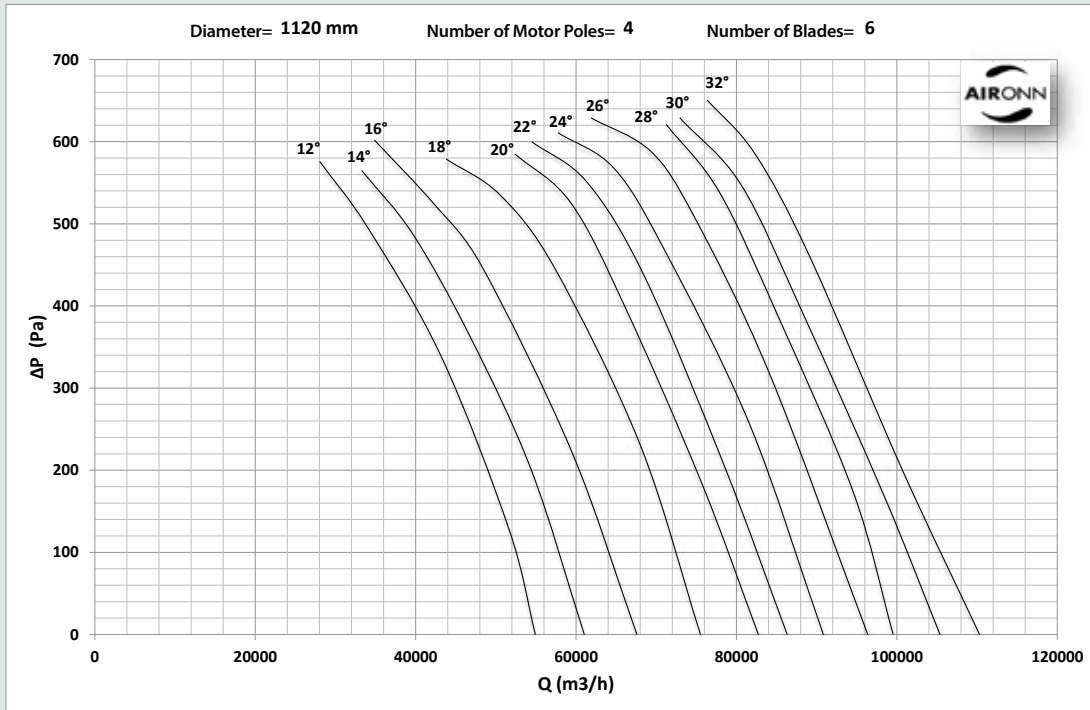

# Axial Type Silencer Body Smoke Exhaust Fan

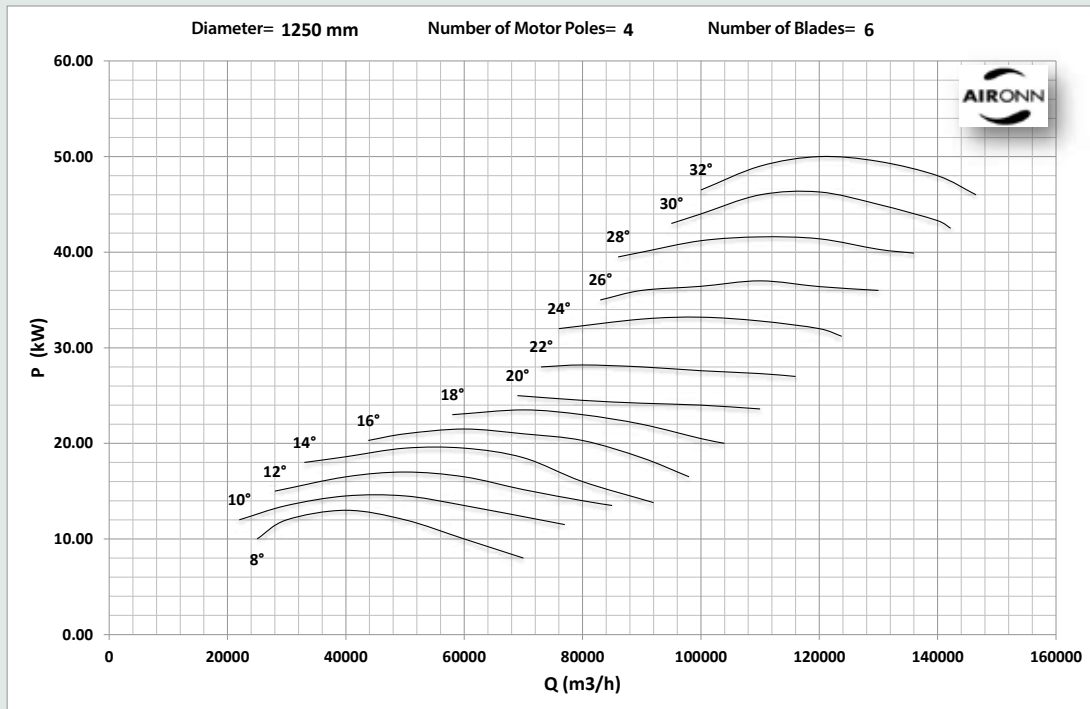
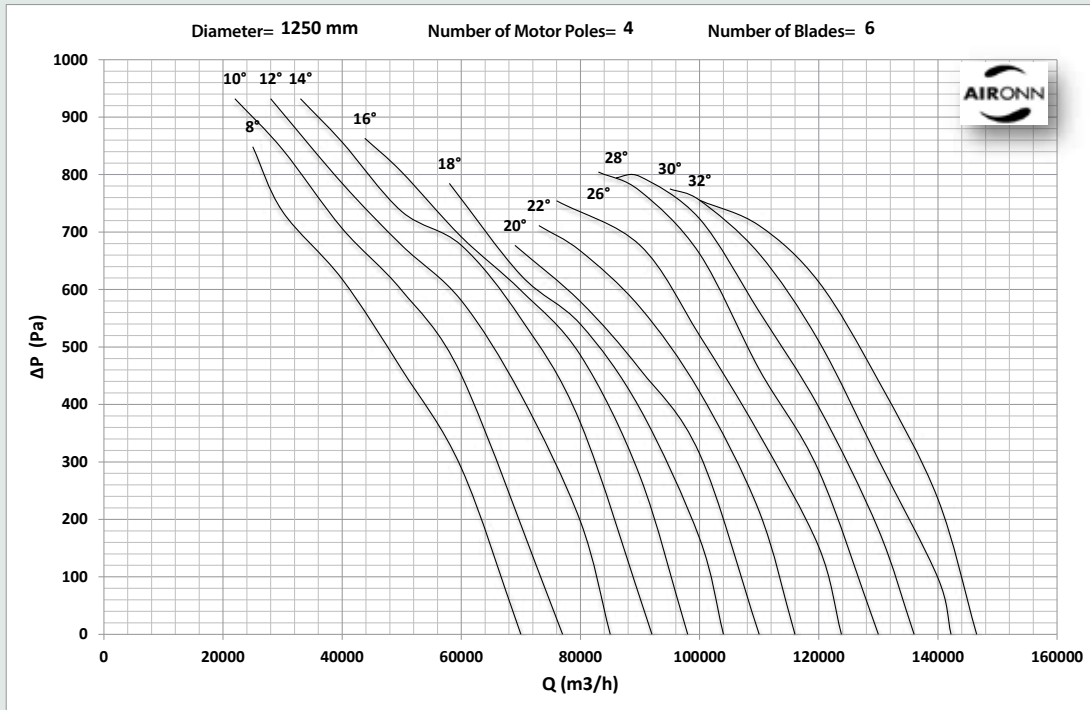

# Axial Type Silencer Body Smoke Exhaust Fan

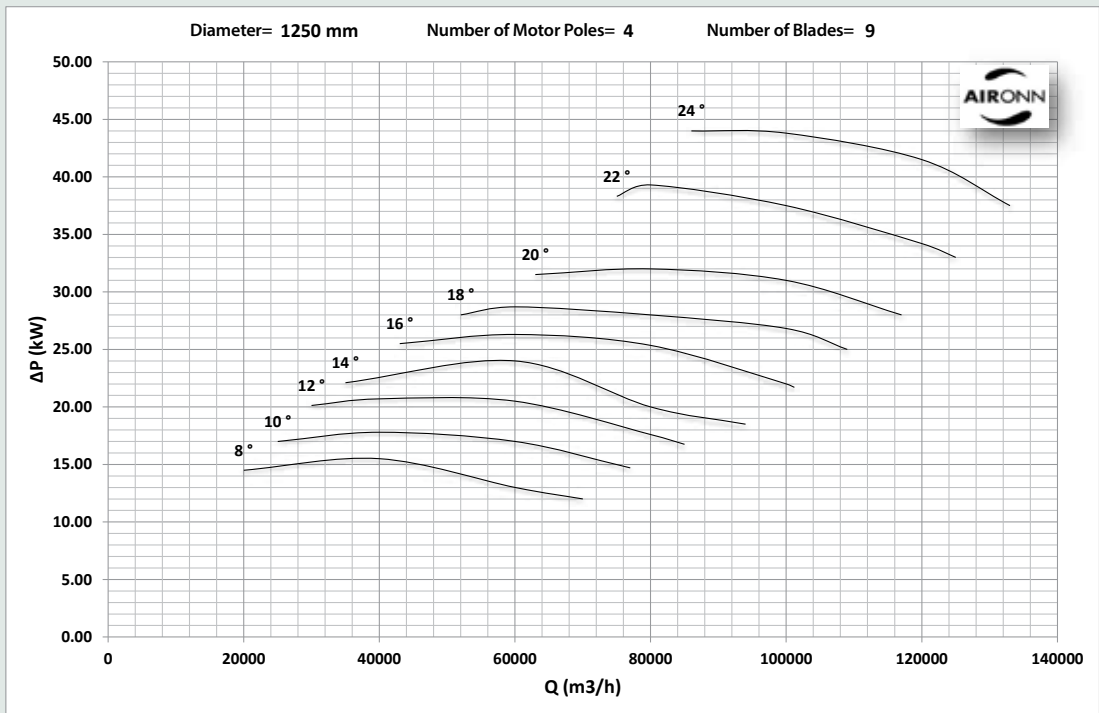
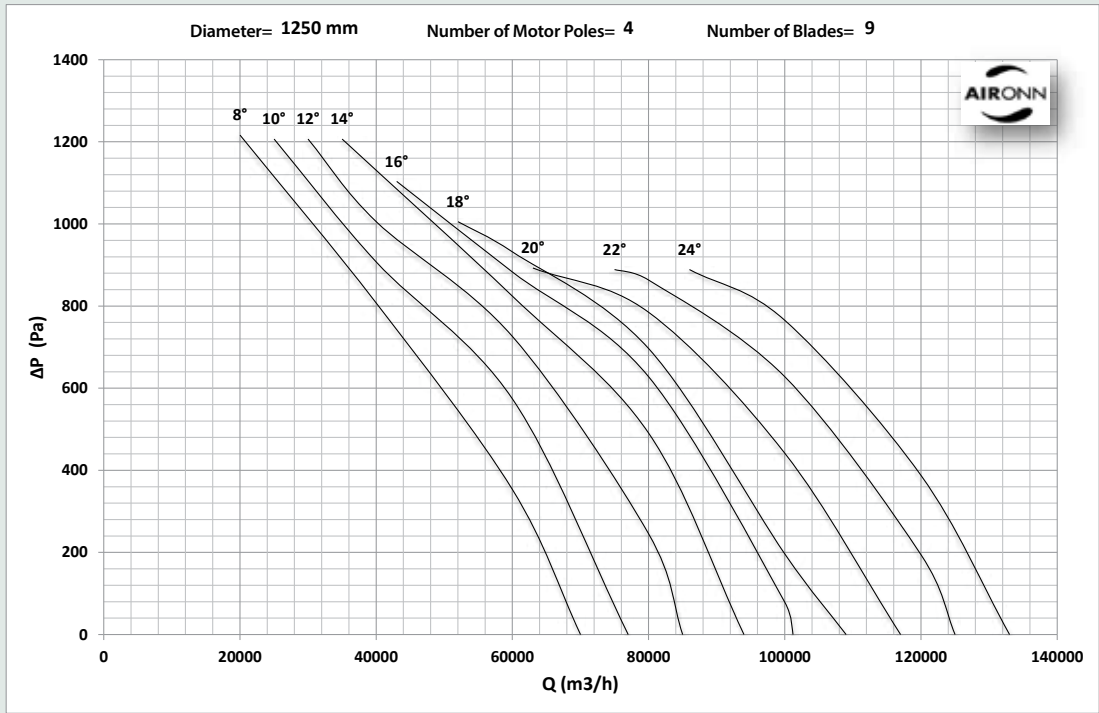



# Axial Type Silencer Body Smoke Exhaust Fan

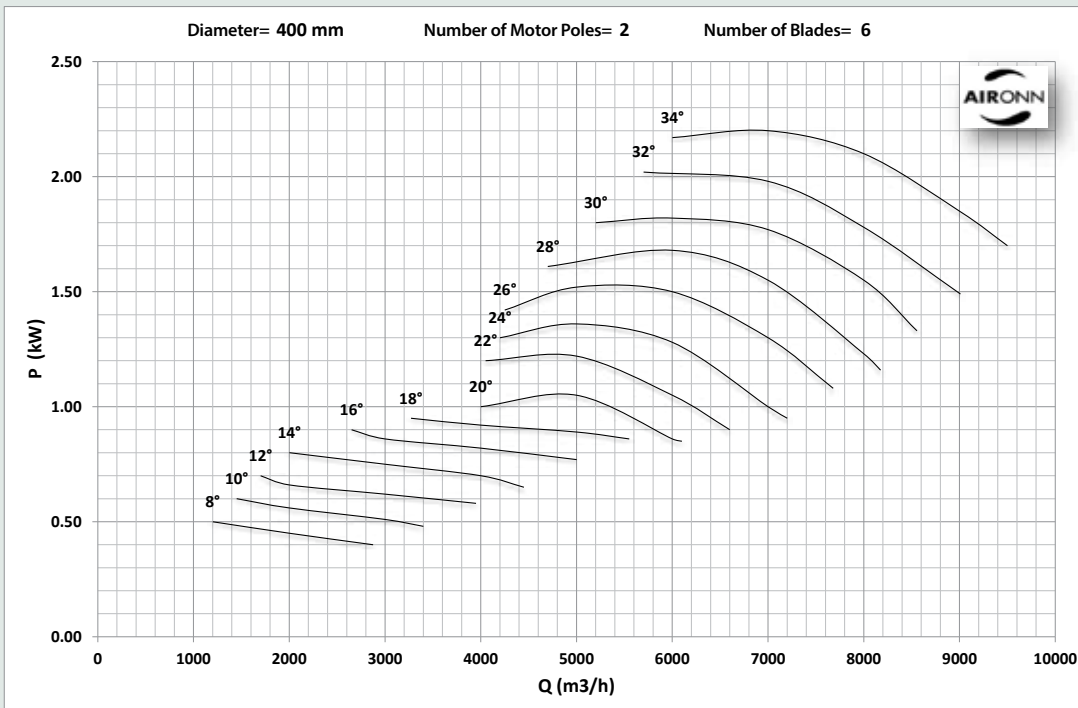
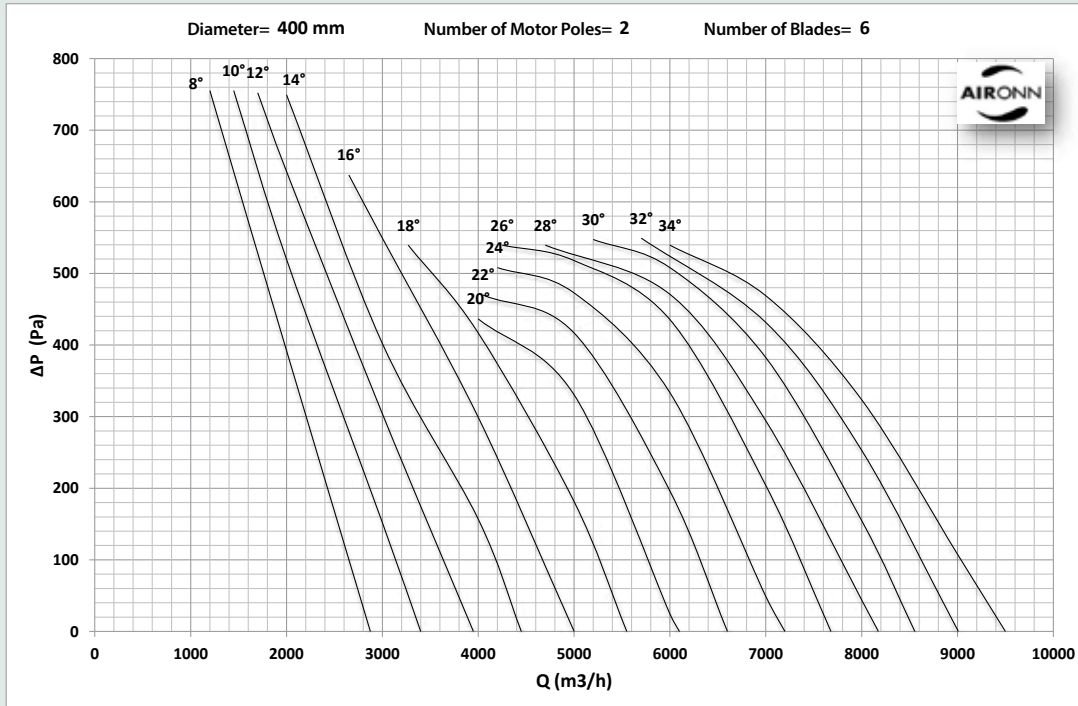

# Axial Type Silencer Body Smoke Exhaust Fan

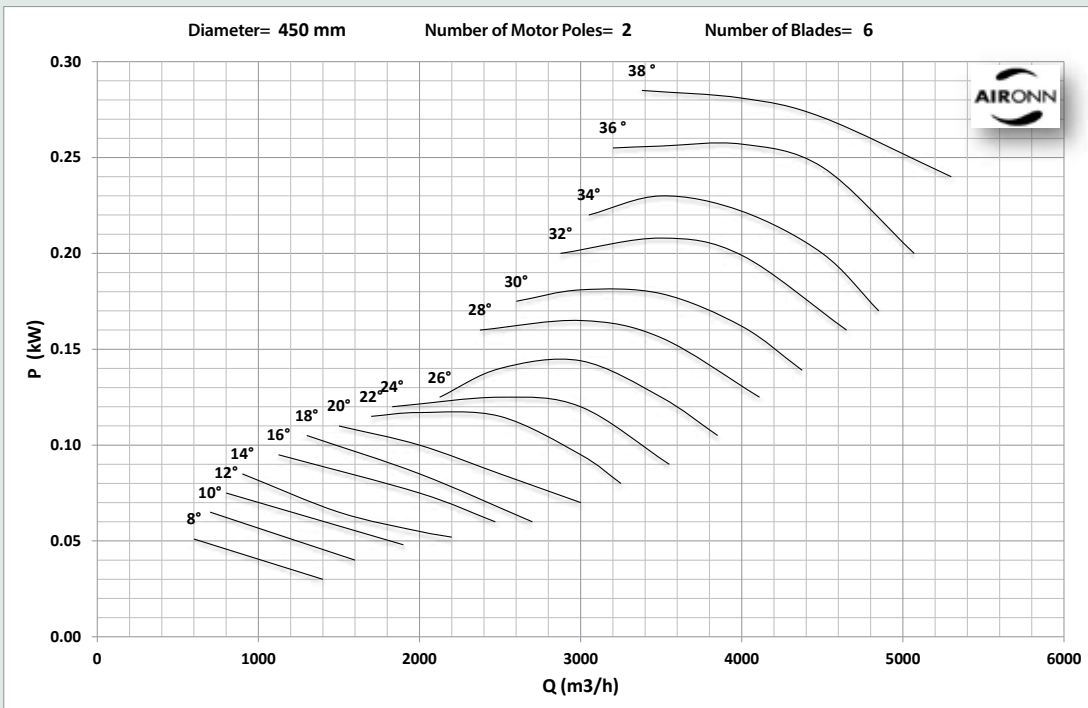
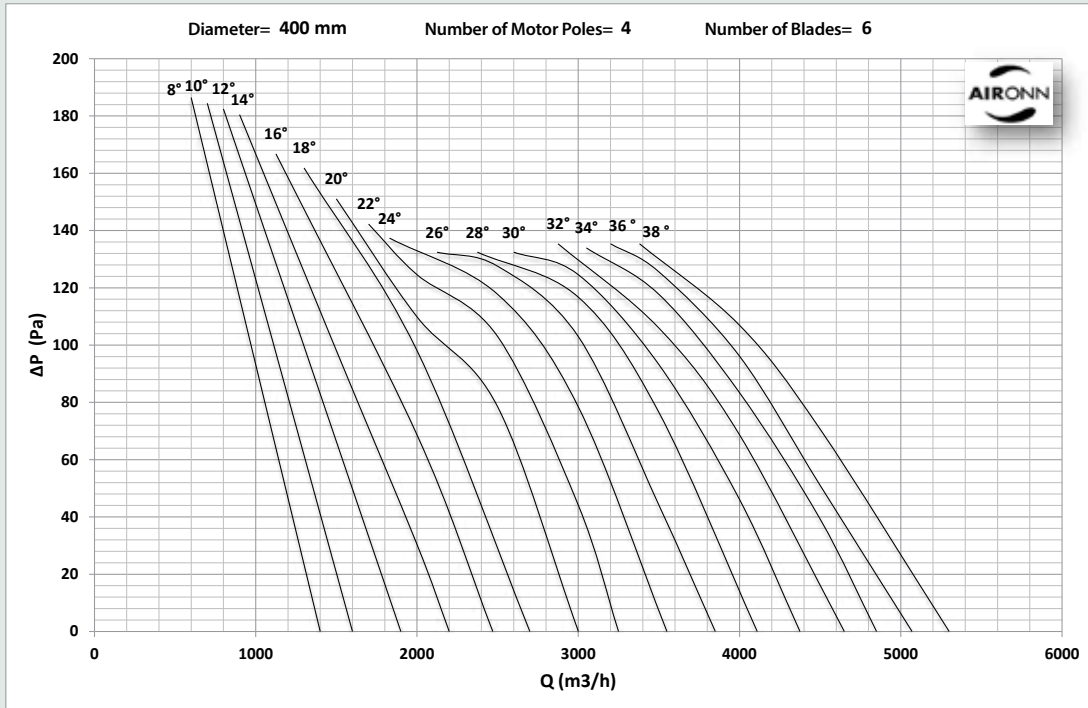

# Axial Type Silencer Body Smoke Exhaust Fan

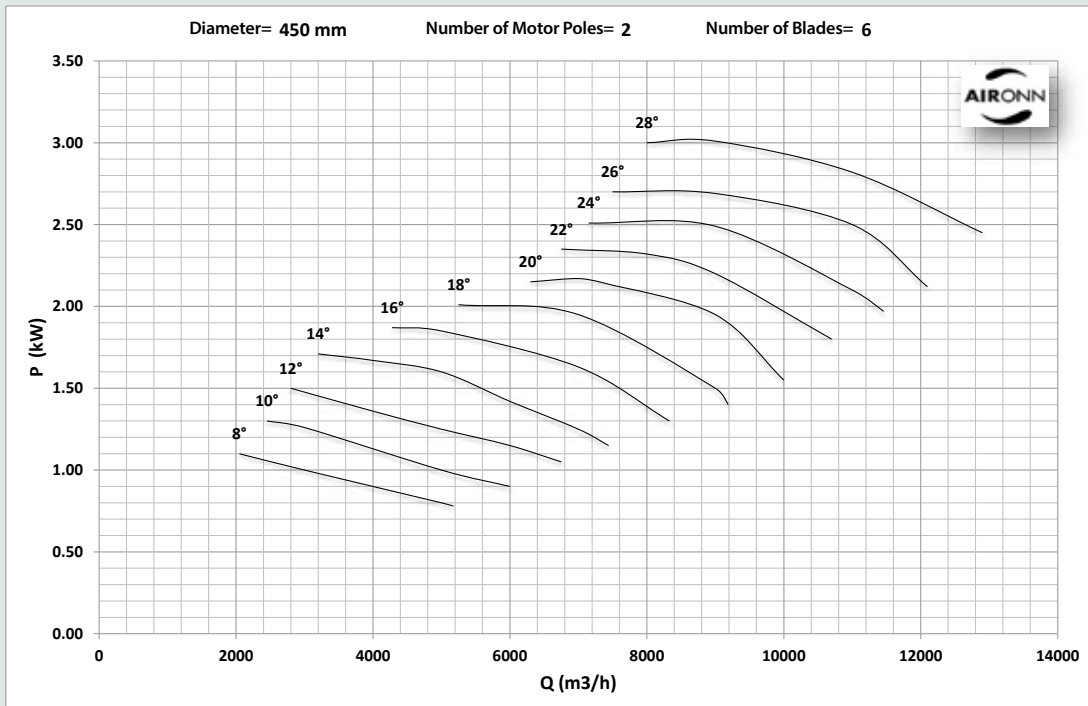
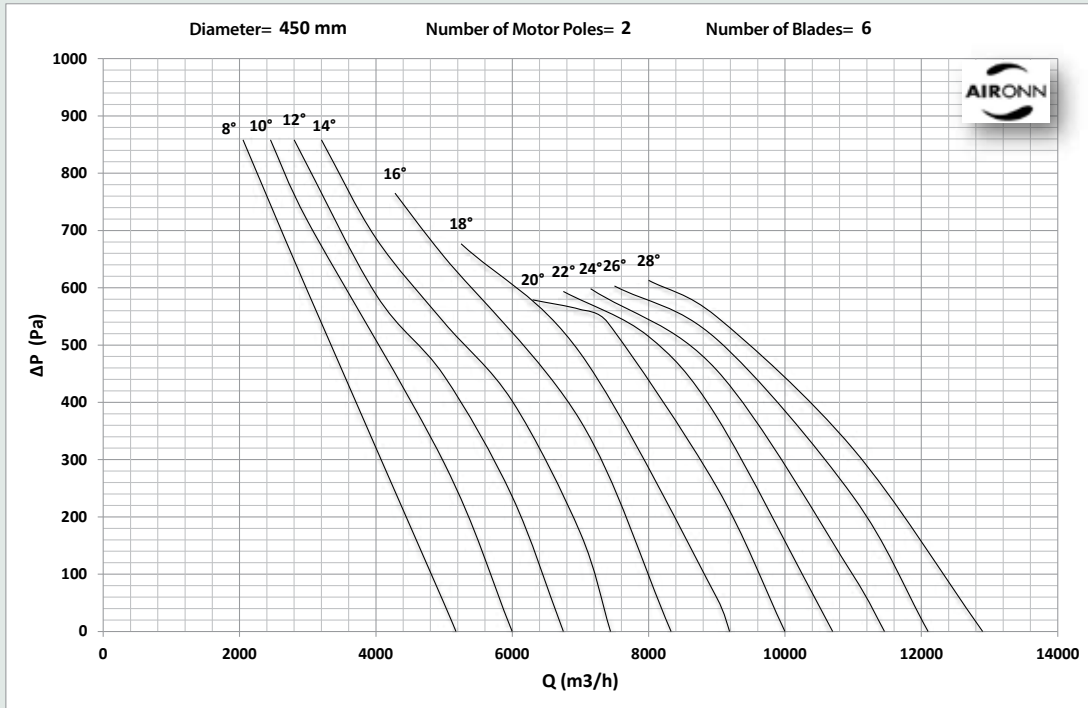

# Axial Type Silencer Body Smoke Exhaust Fan

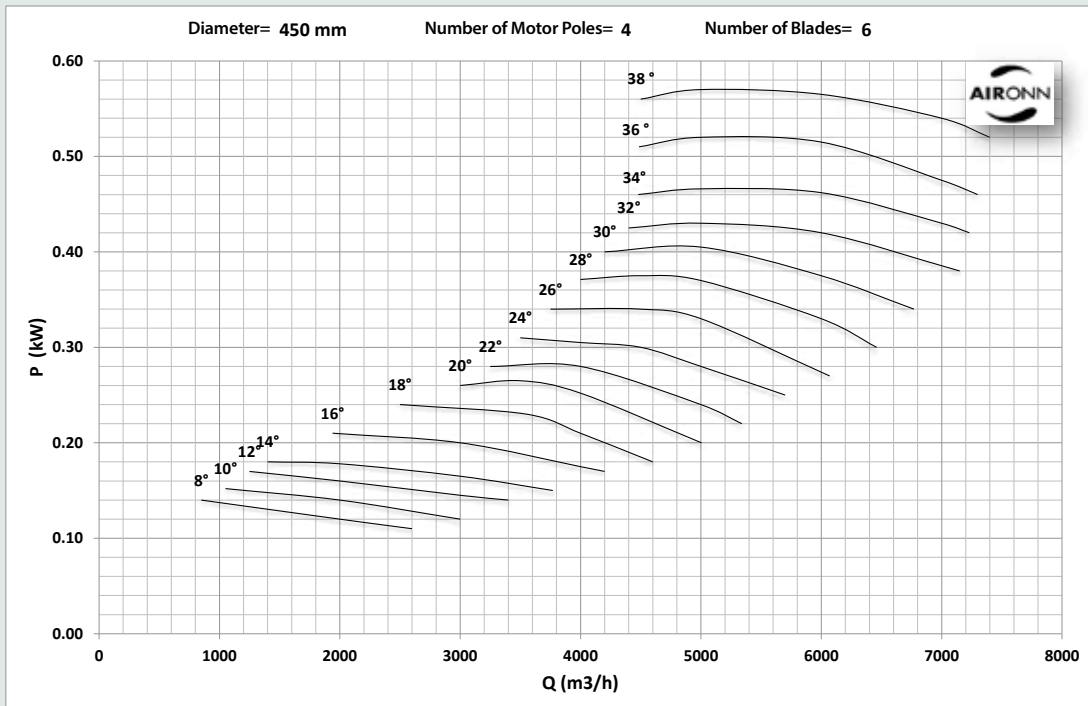
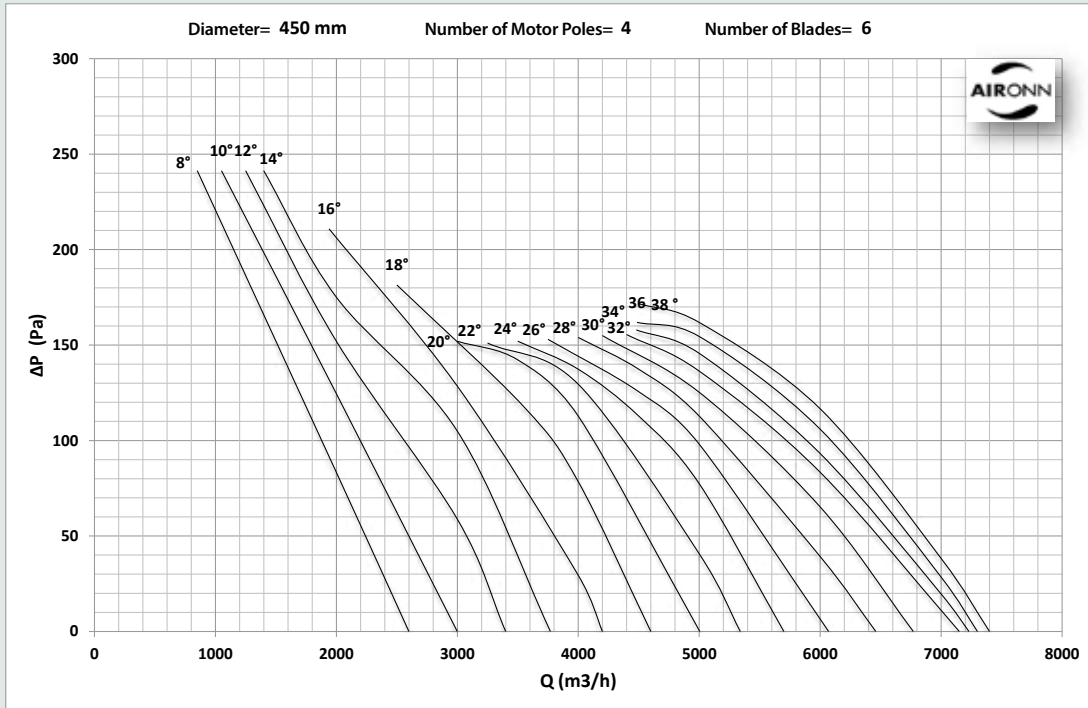

# Axial Type Silencer Body Smoke Exhaust Fan

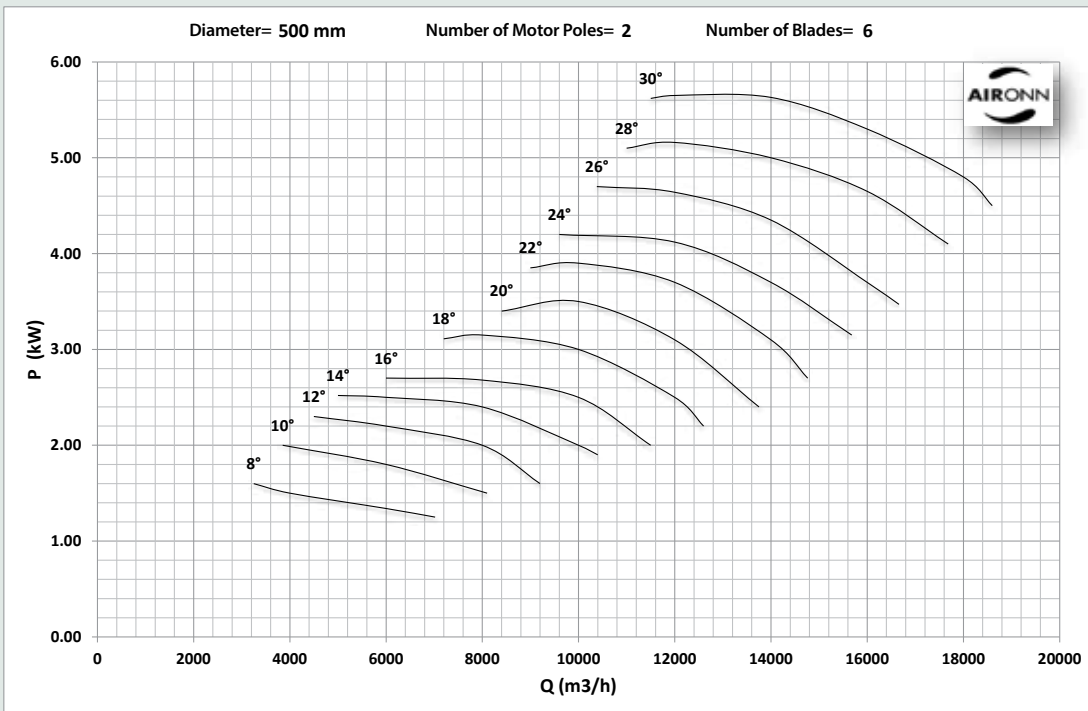
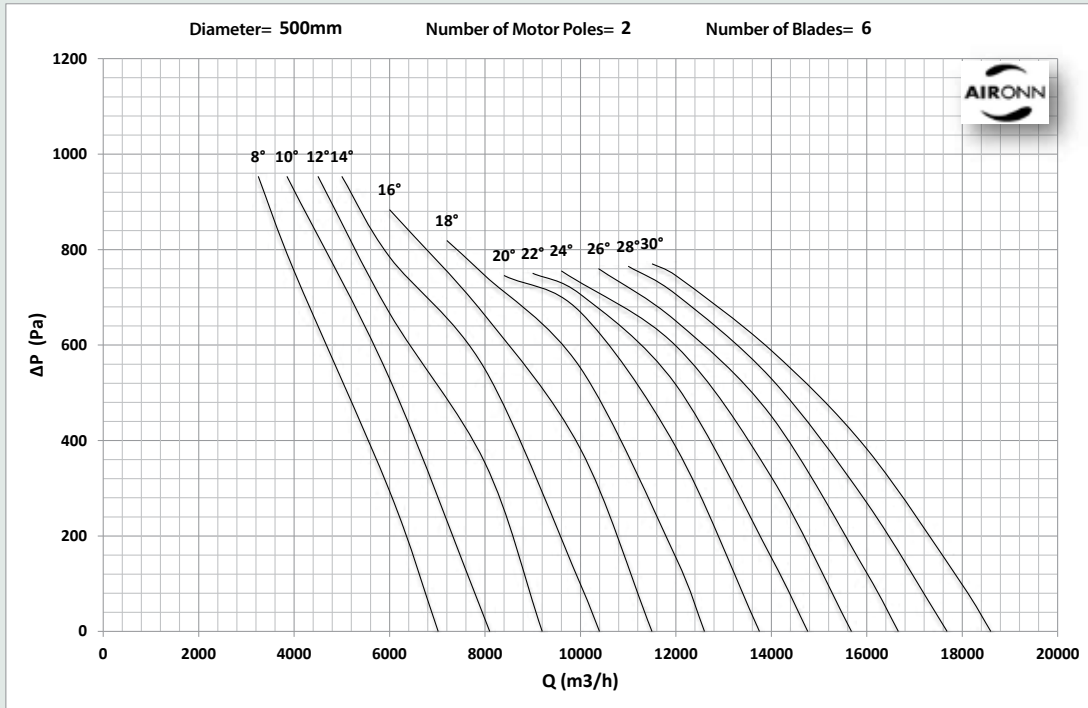

# Axial Type Silencer Body Smoke Exhaust Fan

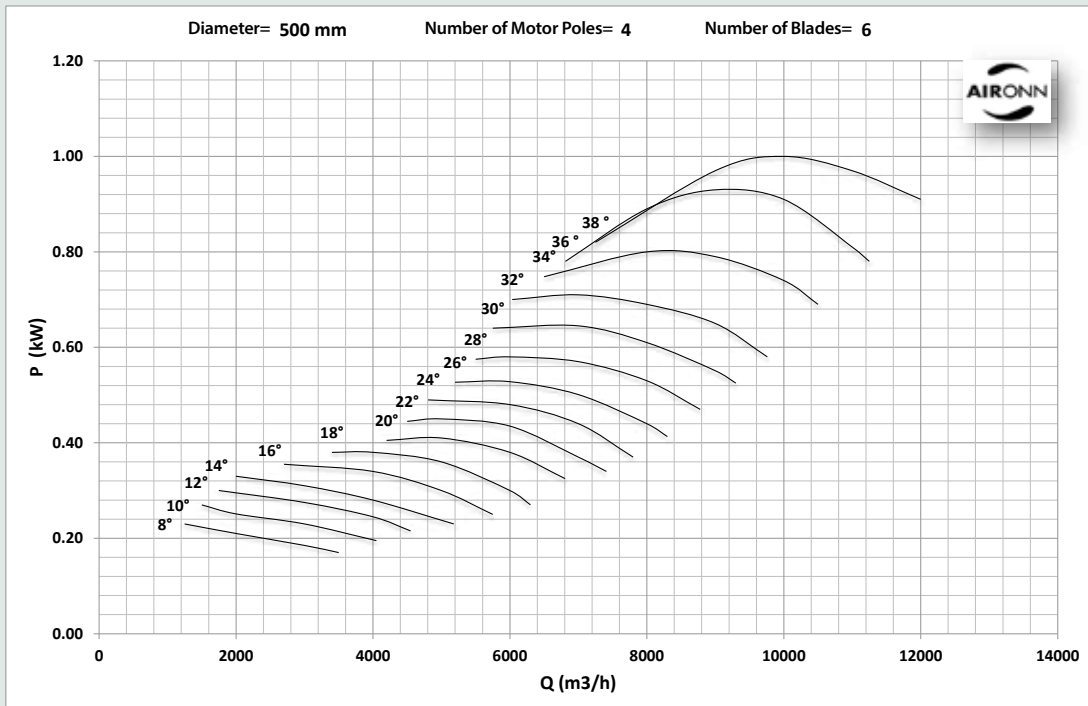
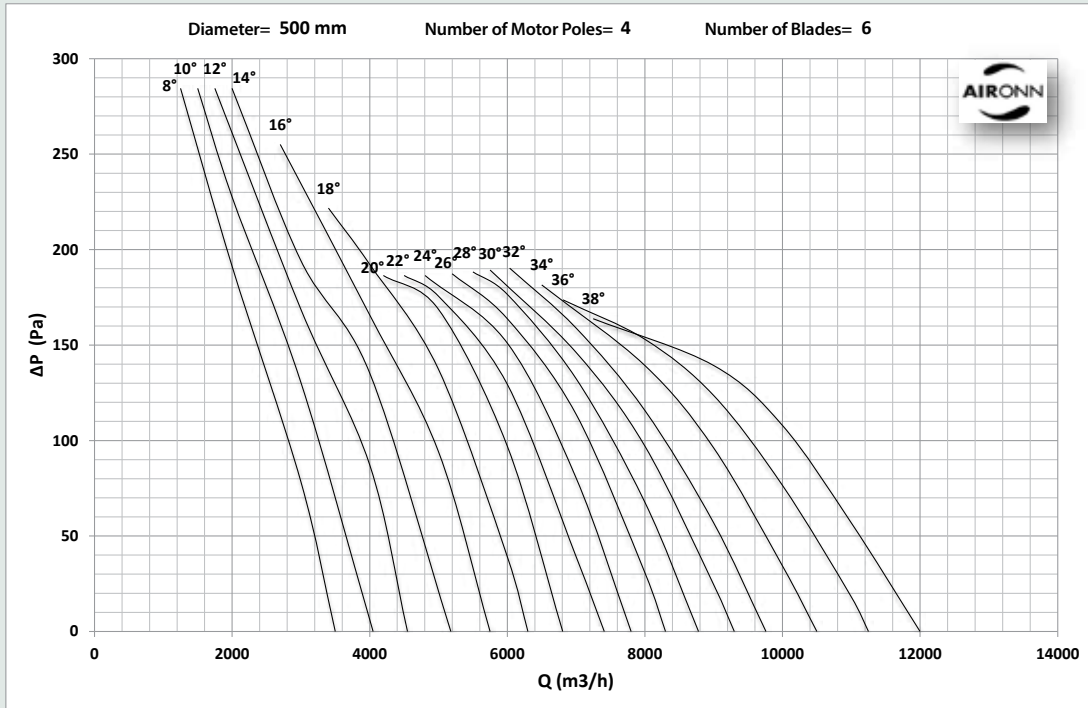

# Axial Type Silencer Body Smoke Exhaust Fan

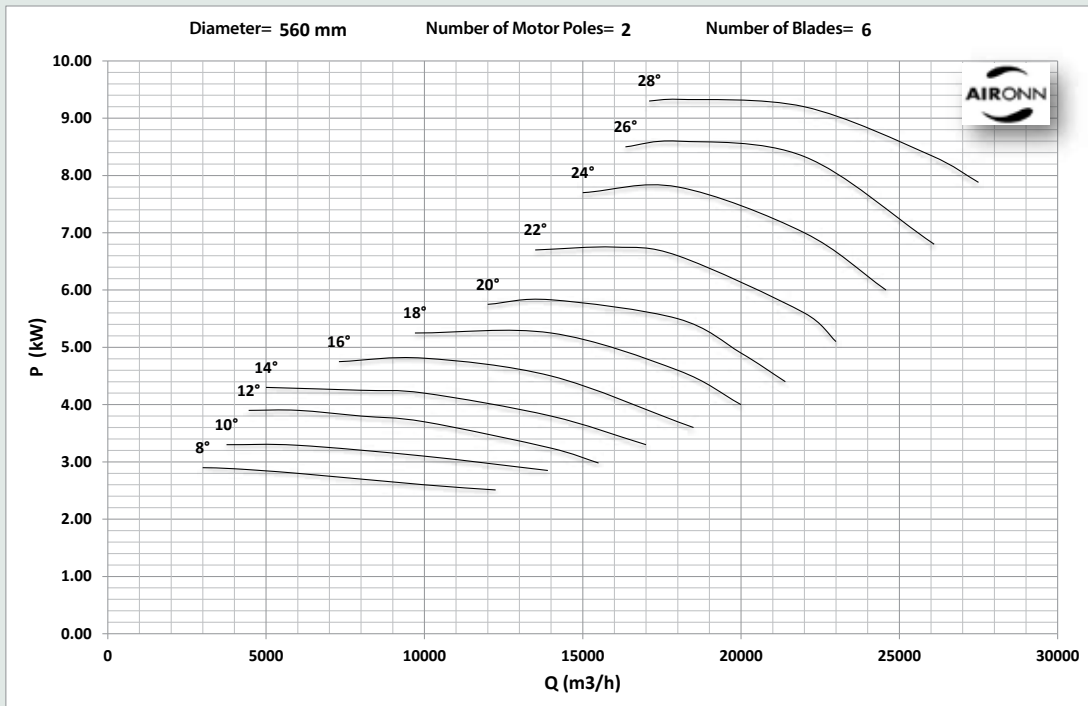
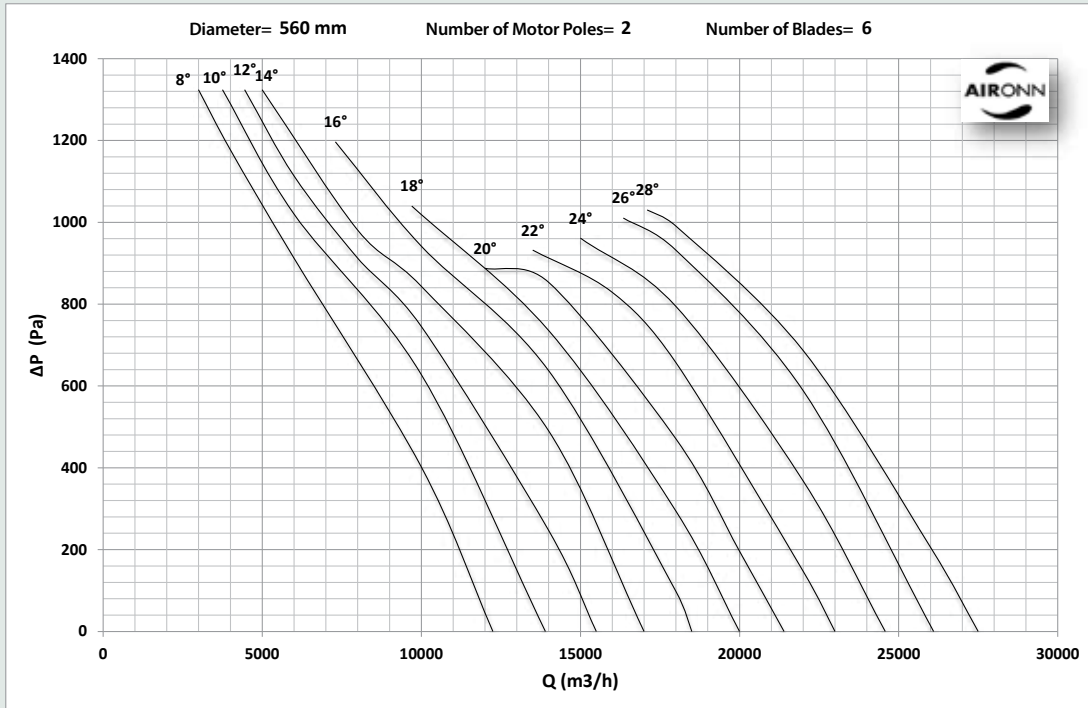

# Axial Type Silencer Body Smoke Exhaust Fan

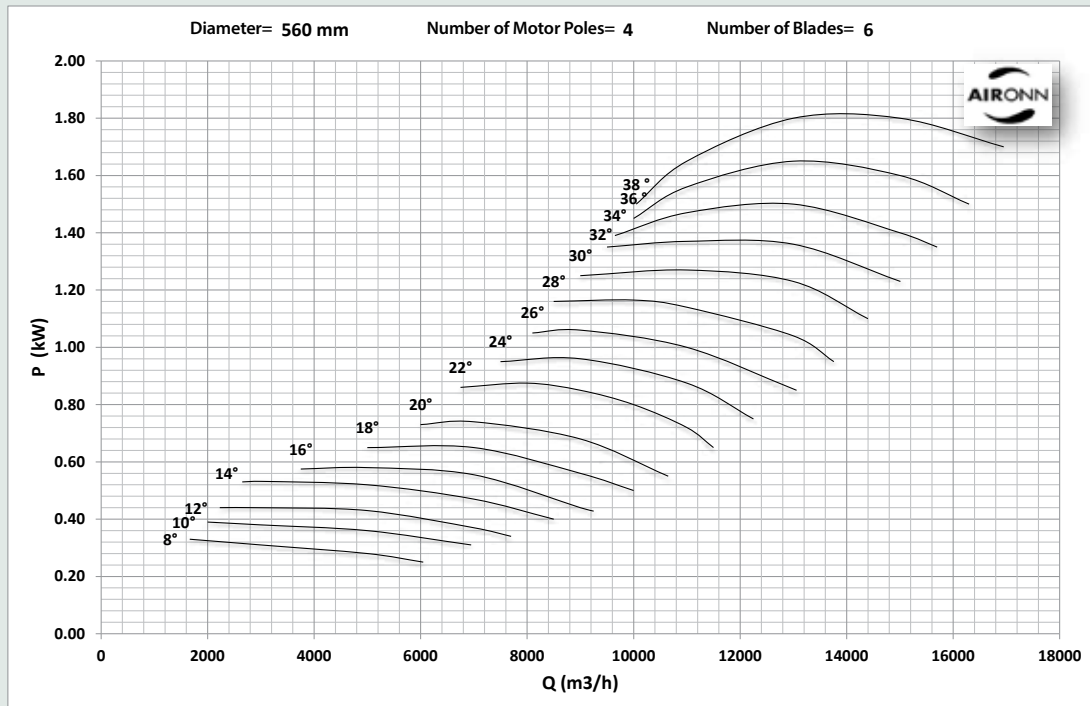
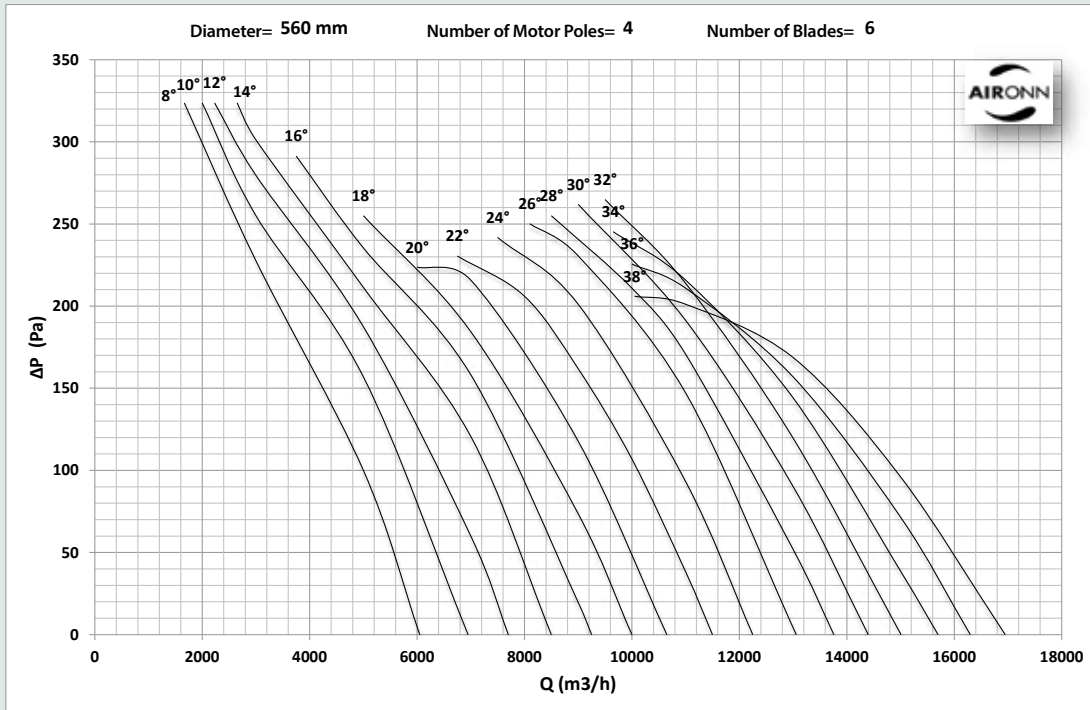



# Axial Type Silencer Body Smoke Exhaust Fan

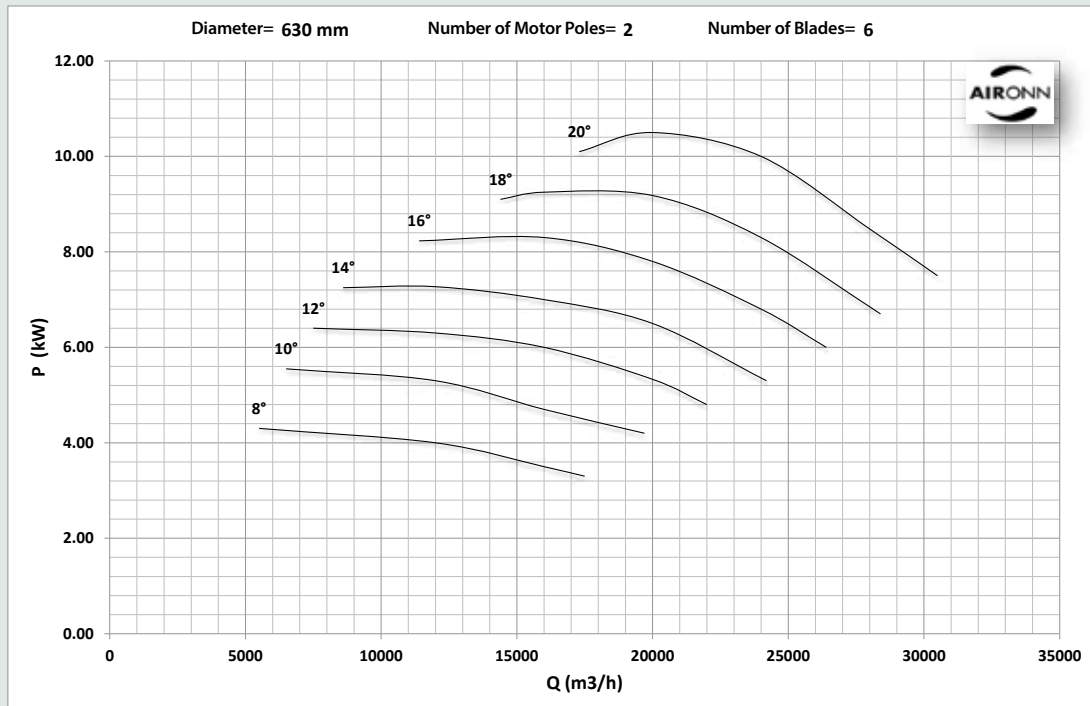
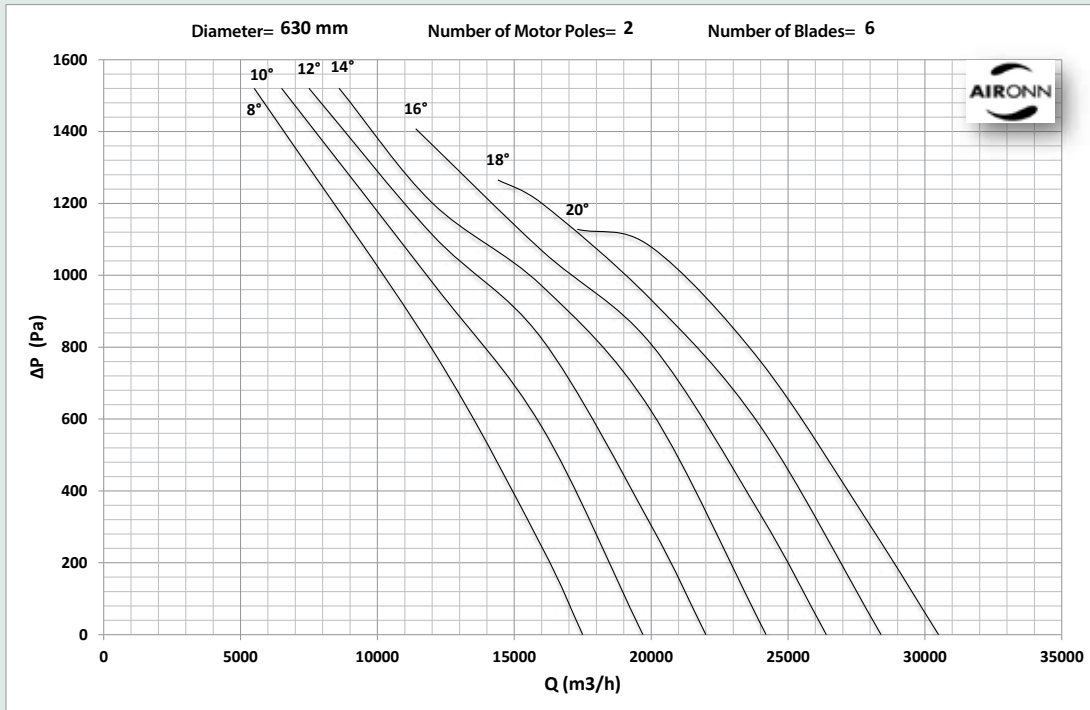

# Axial Type Silencer Body Smoke Exhaust Fan

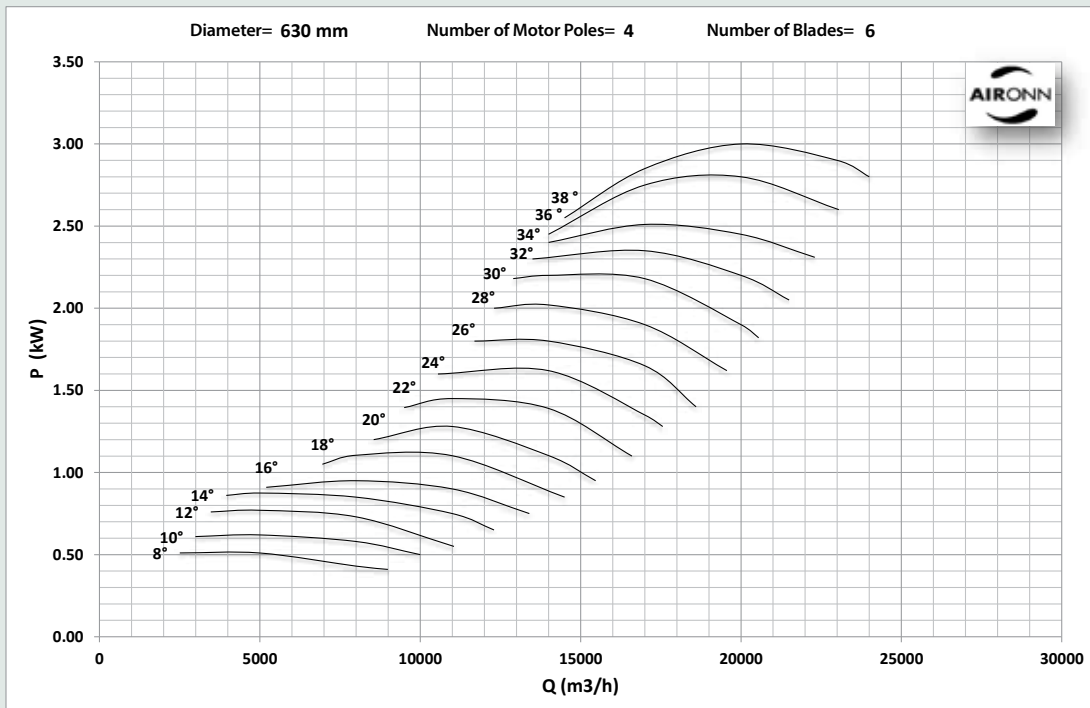
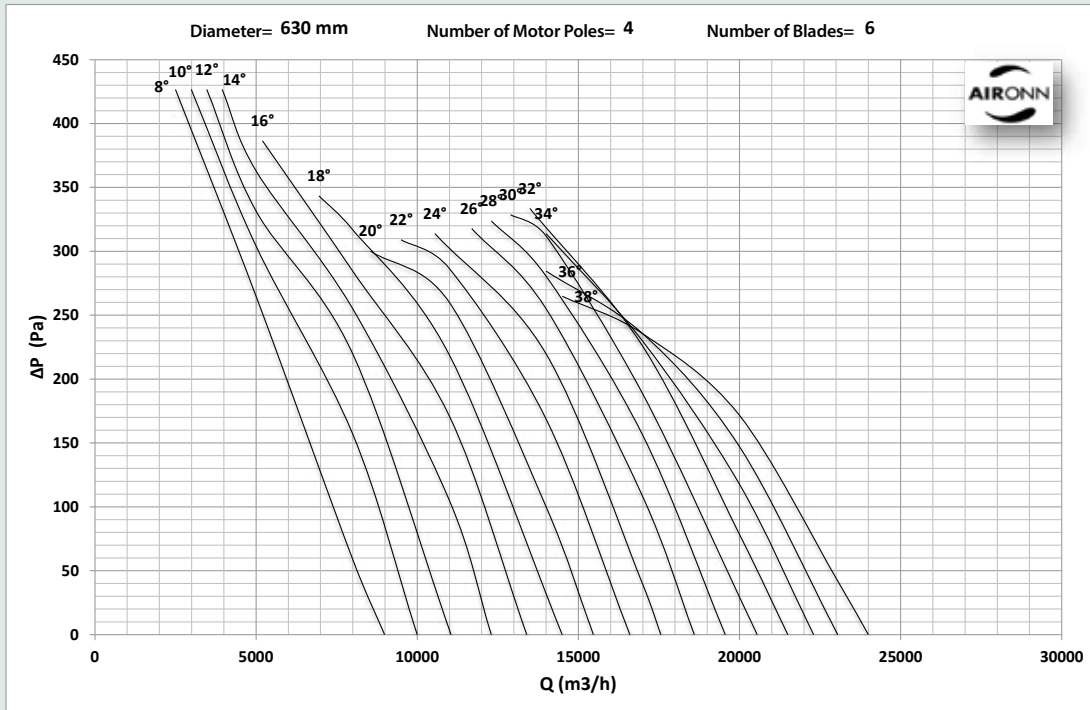

# Axial Type Silencer Body Smoke Exhaust Fan

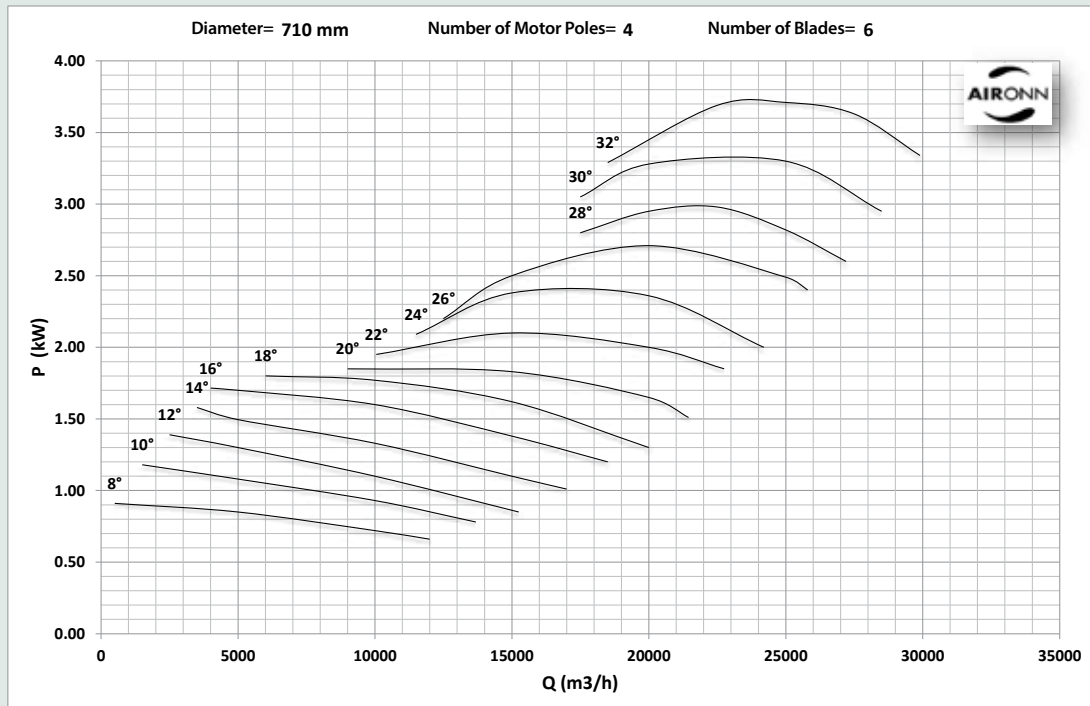
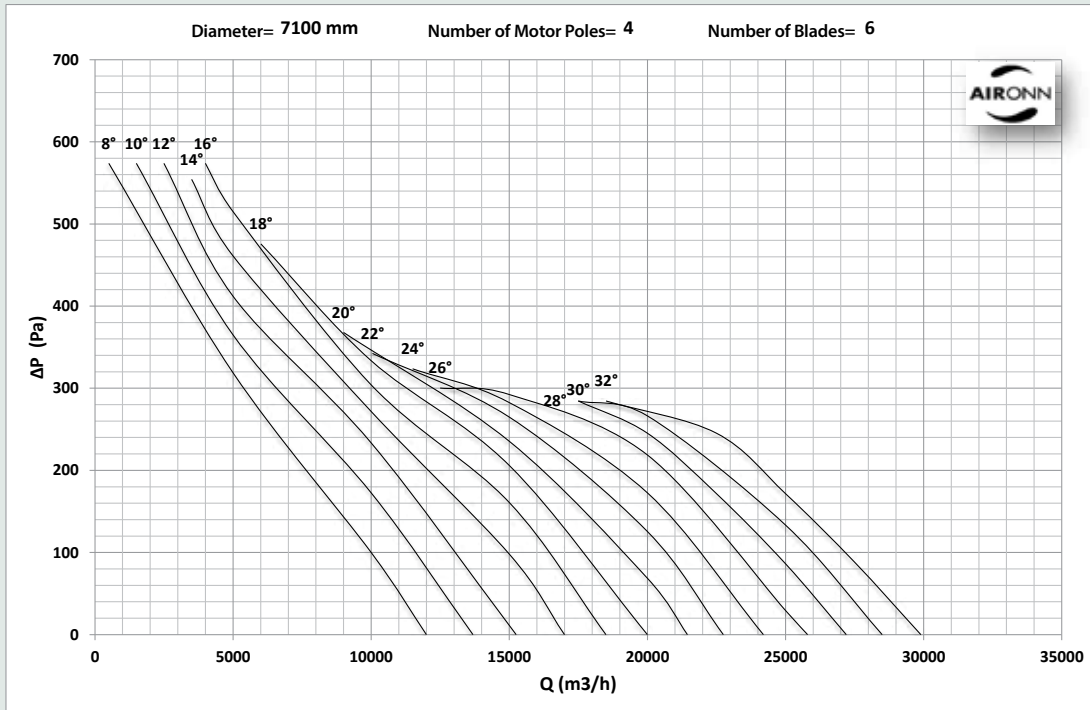

# Axial Type Silencer Body Smoke Exhaust Fan

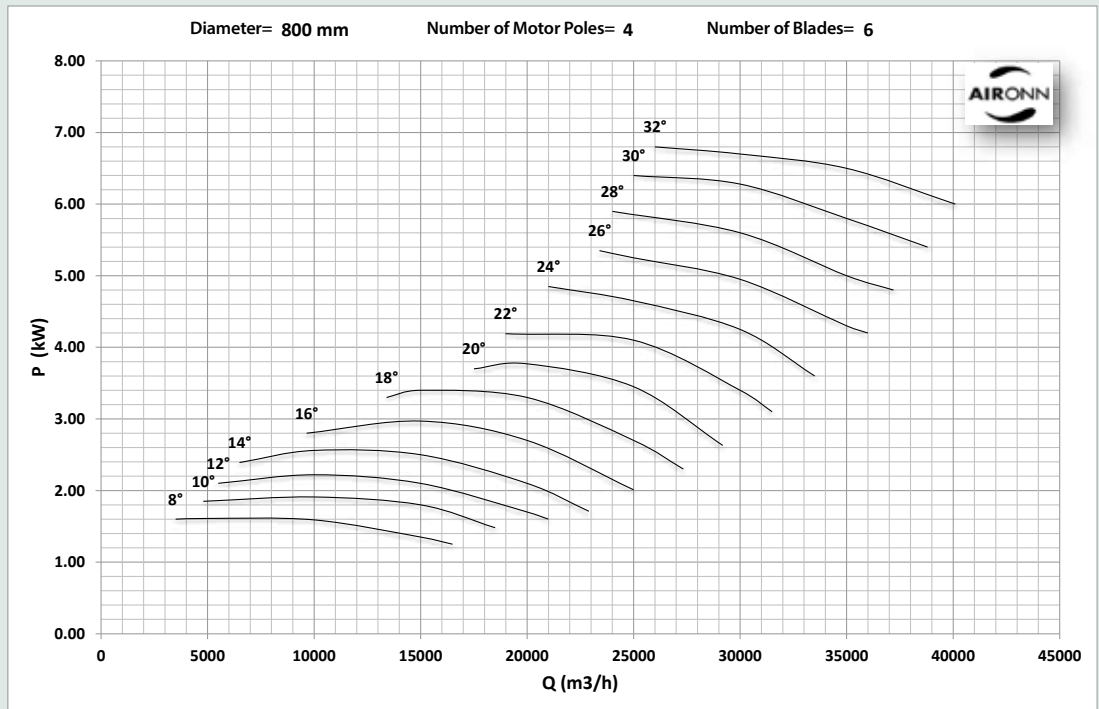
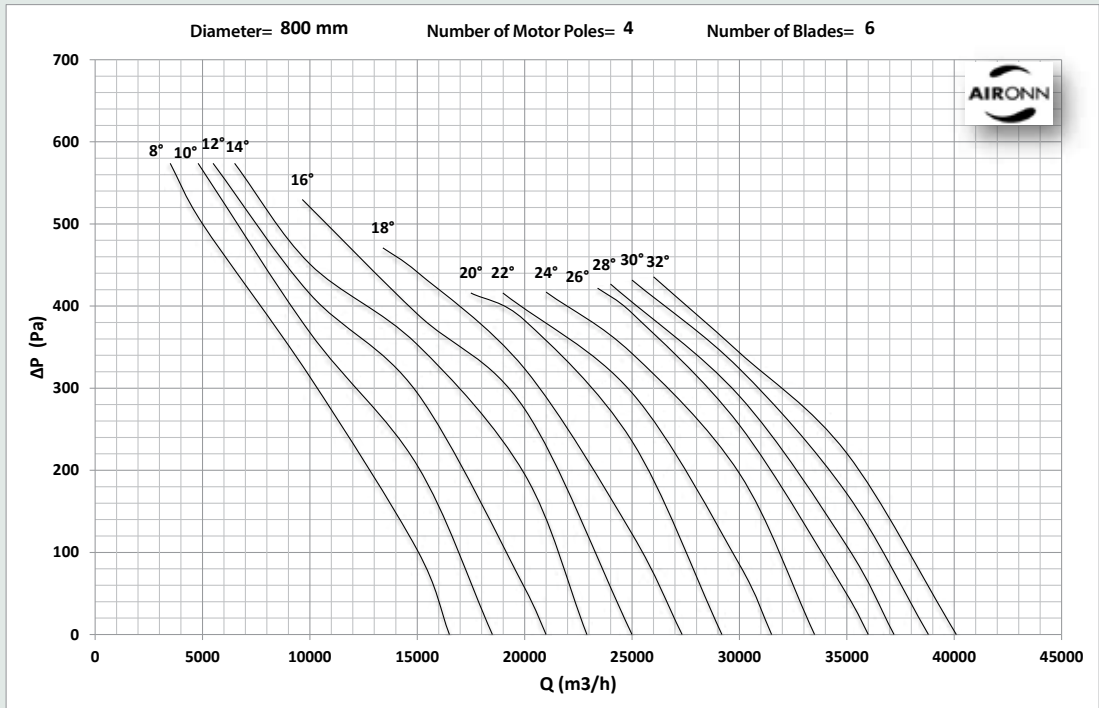

# Axial Type Silencer Body Smoke Exhaust Fan

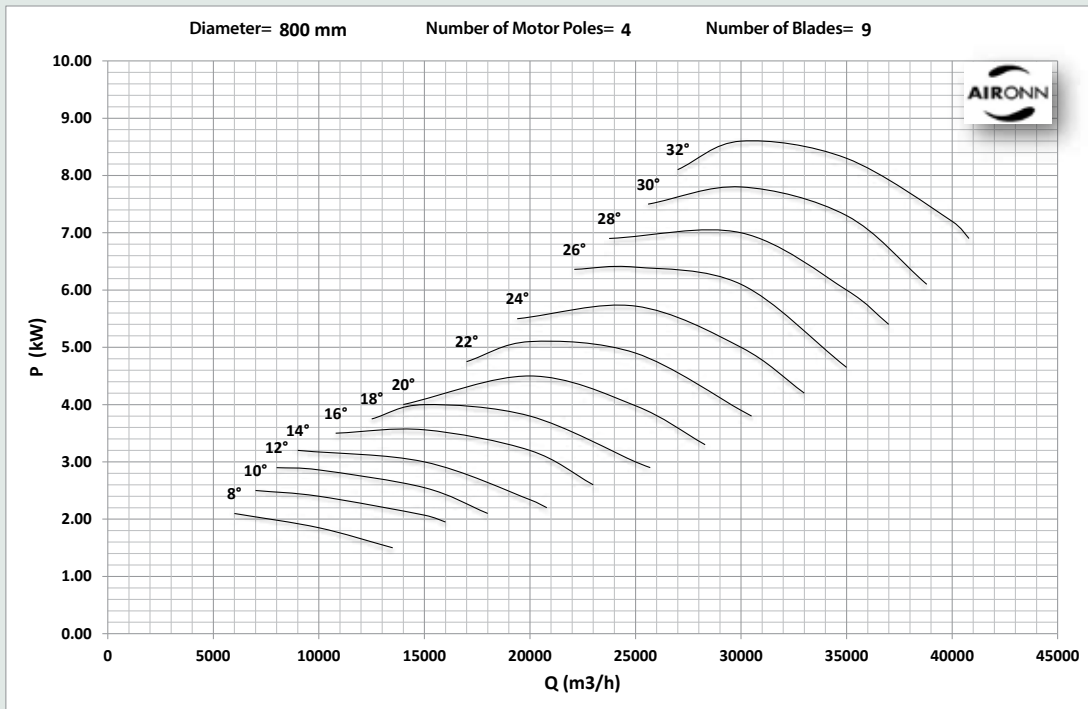
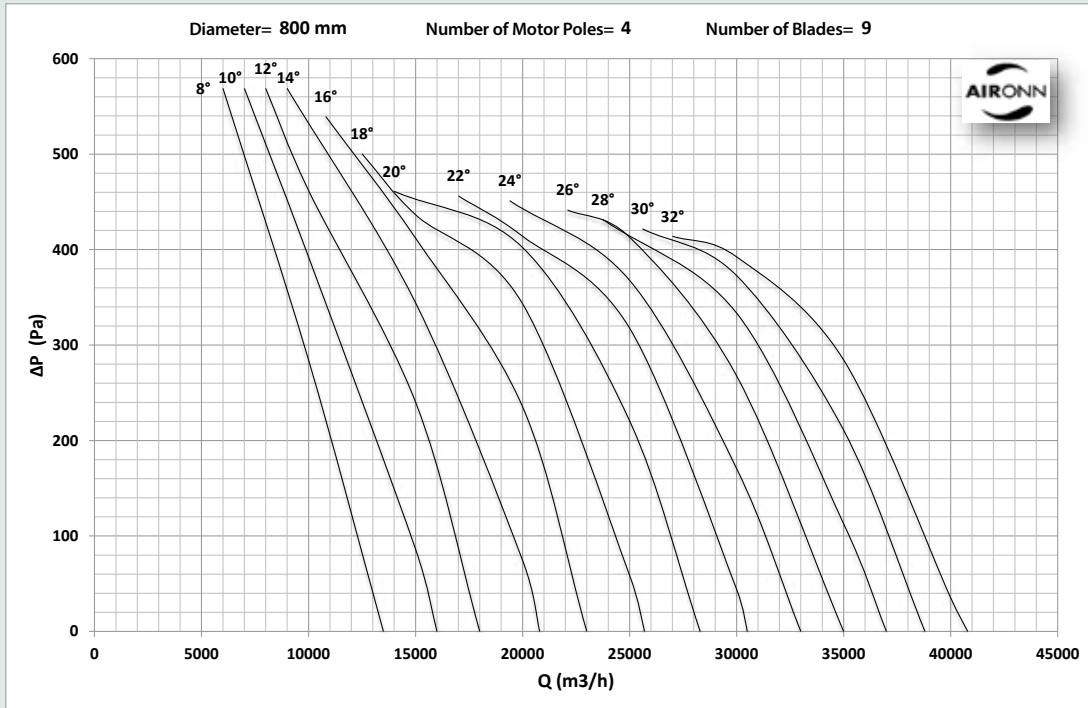

# Axial Type Silencer Body Smoke Exhaust Fan

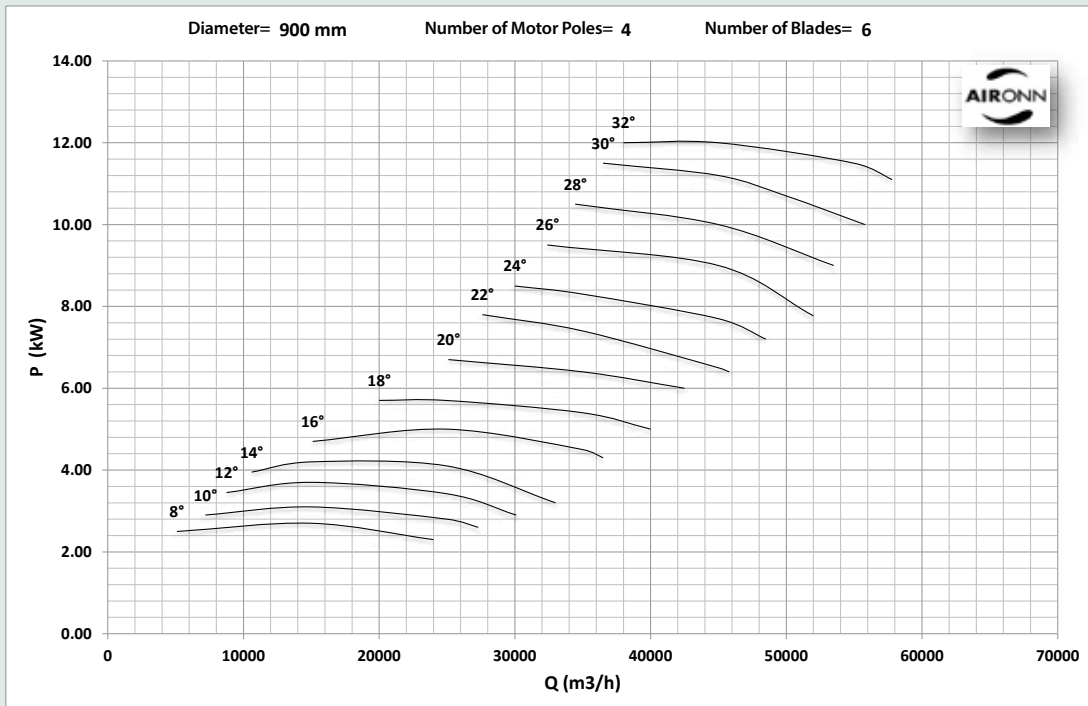
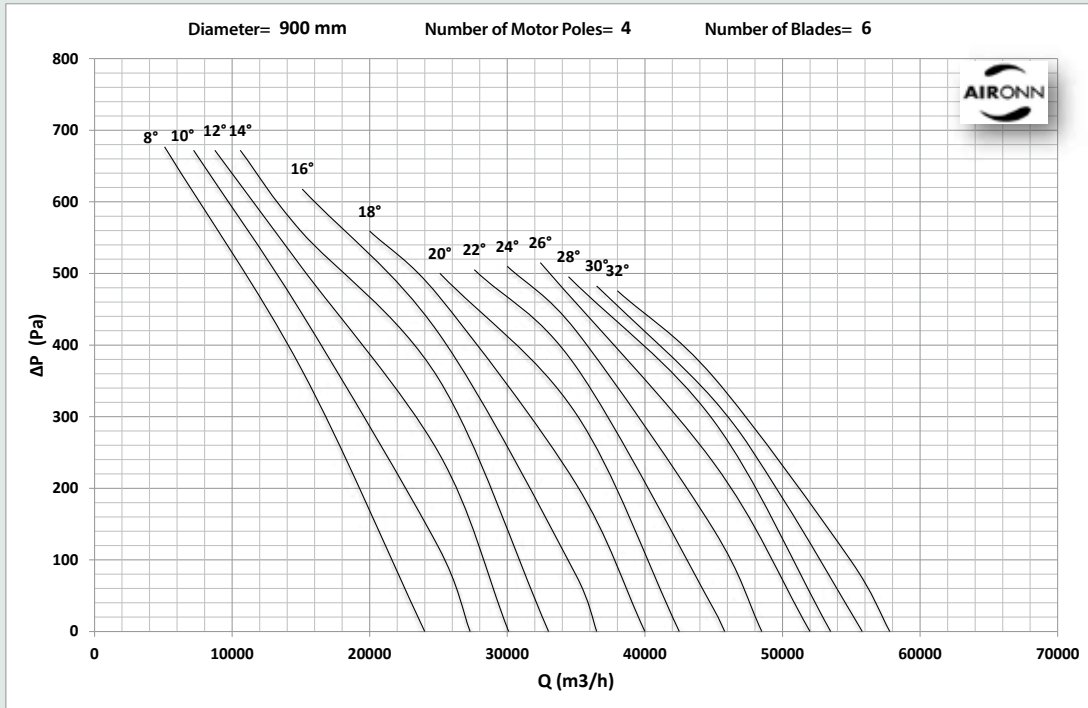

# Axial Type Silencer Body Smoke Exhaust Fan

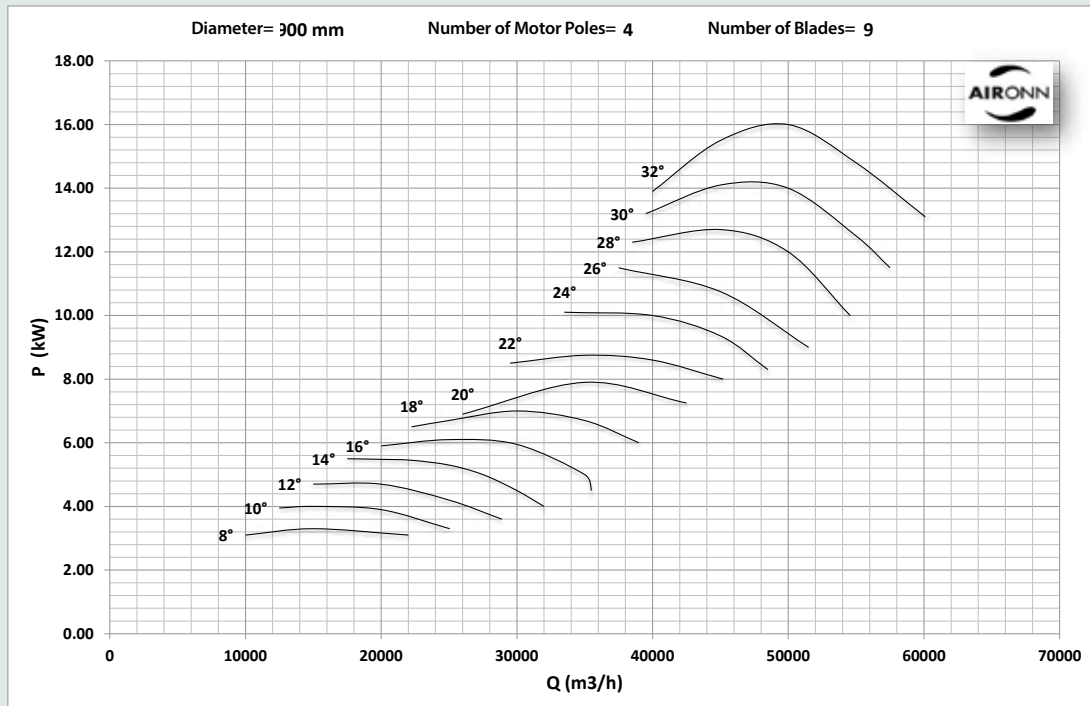
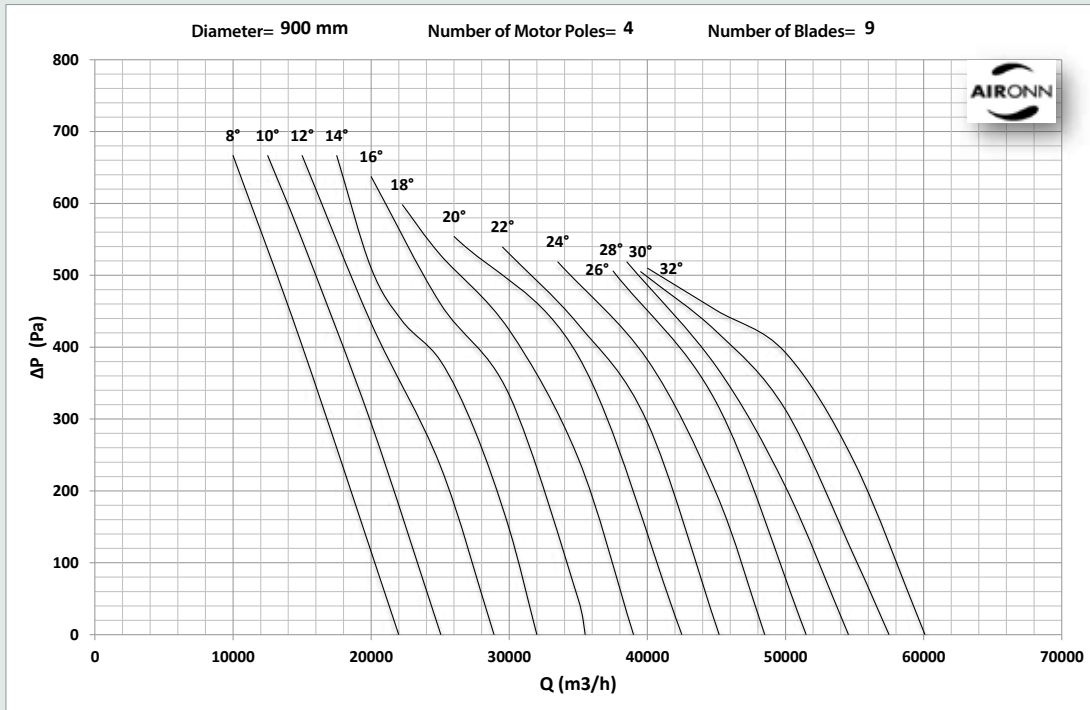

# Axial Type Silencer Body Smoke Exhaust Fan

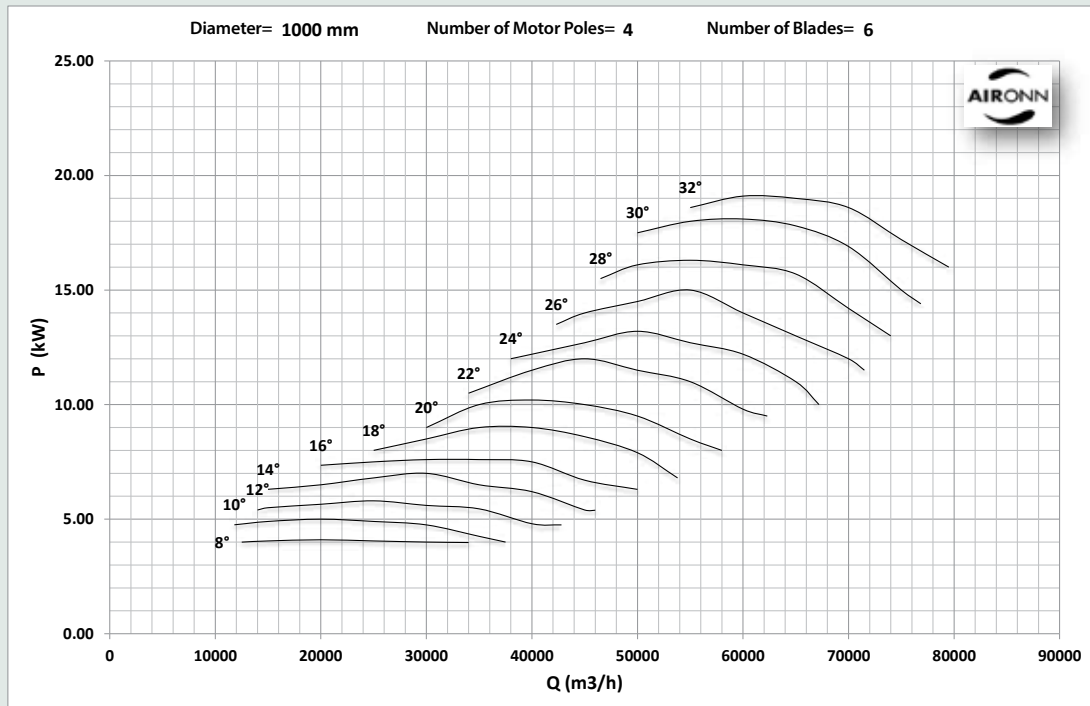
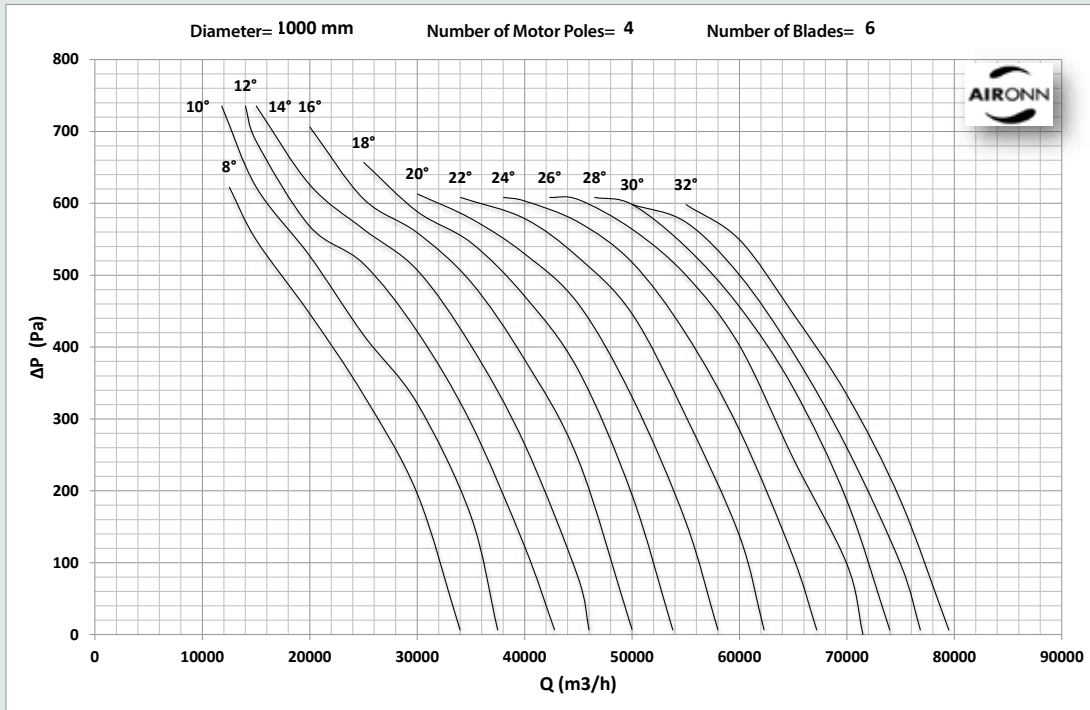



# Axial Type Silencer Body Smoke Exhaust Fan

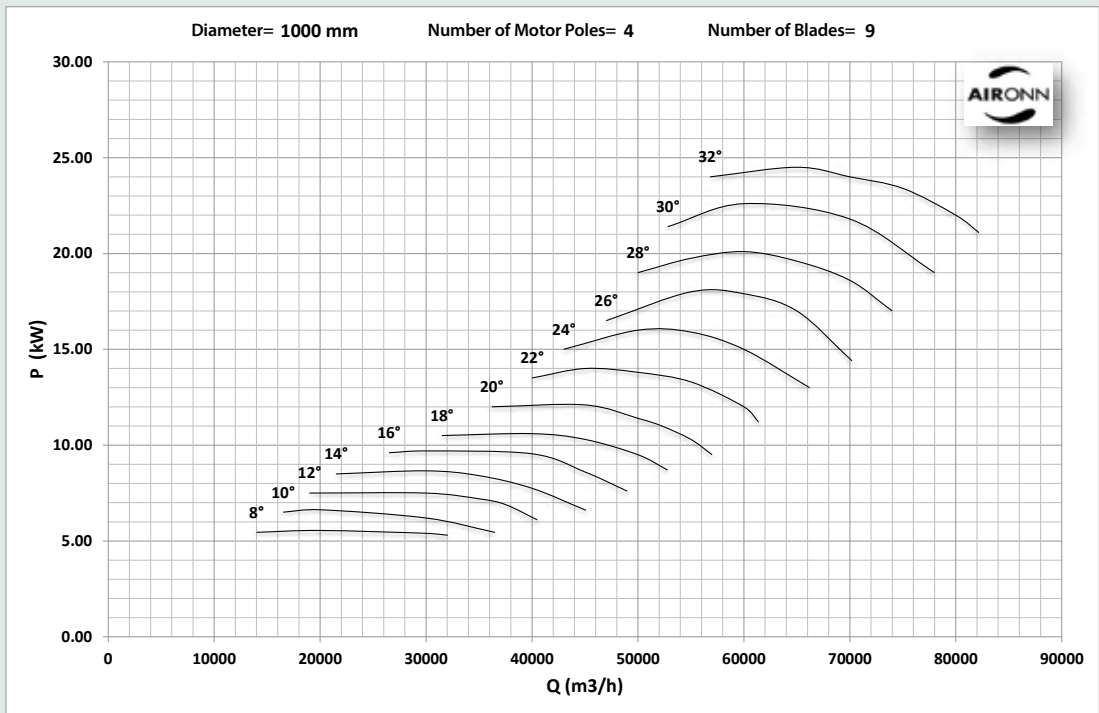
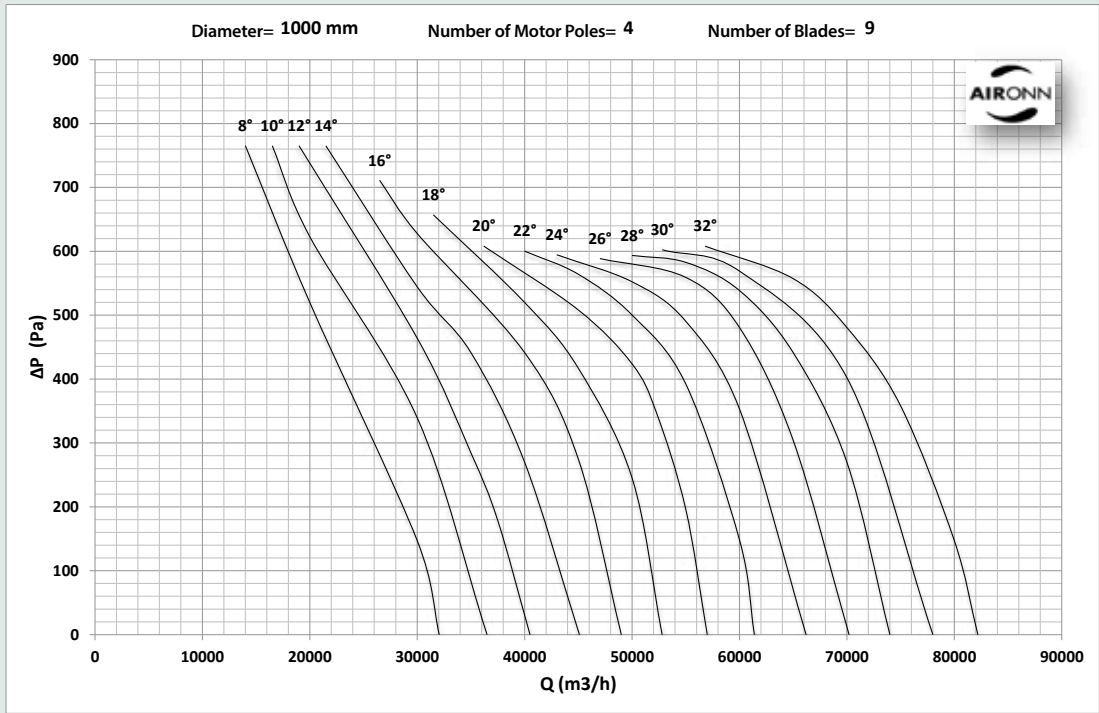

# Axial Type Silencer Body Smoke Exhaust Fan

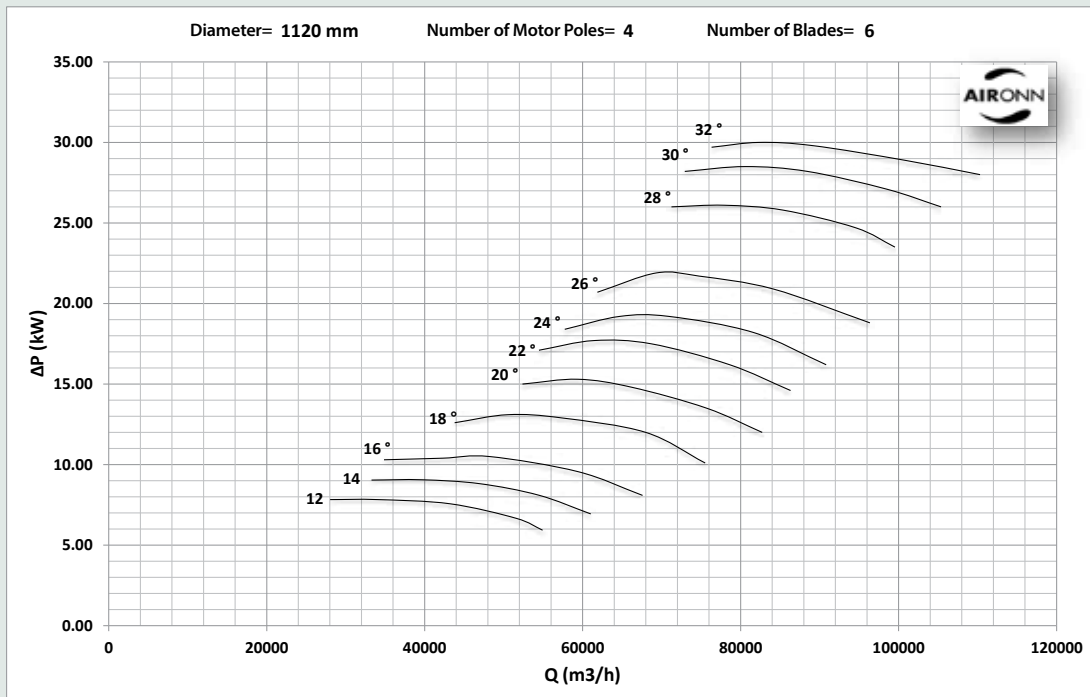
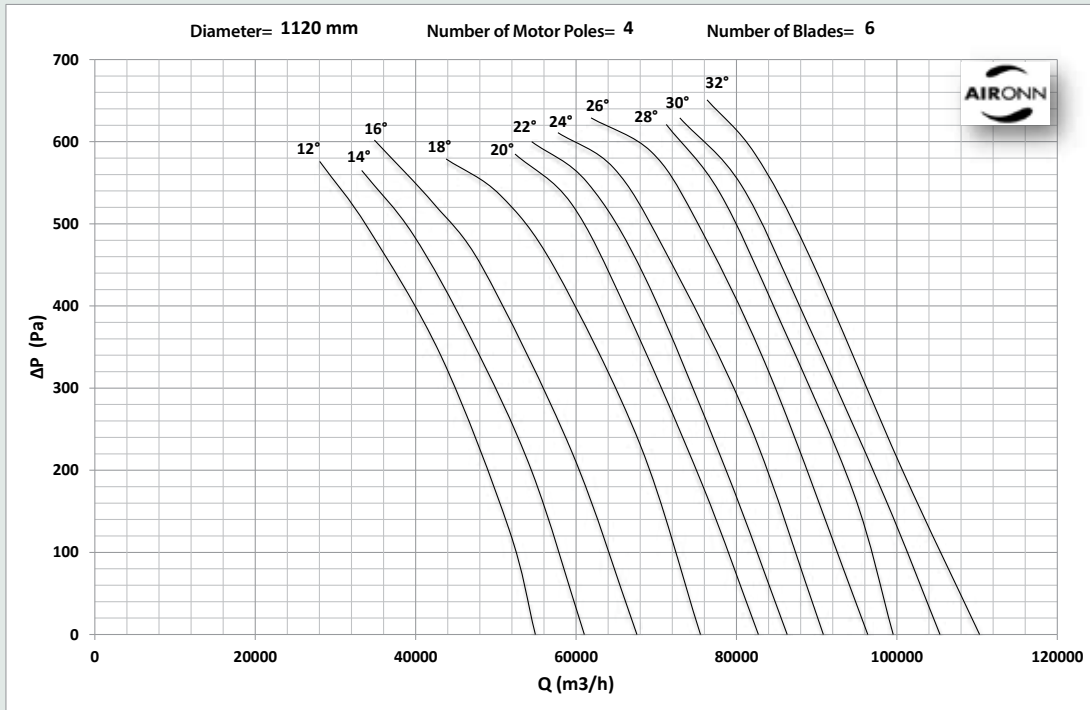

# Axial Type Silencer Body Smoke Exhaust Fan

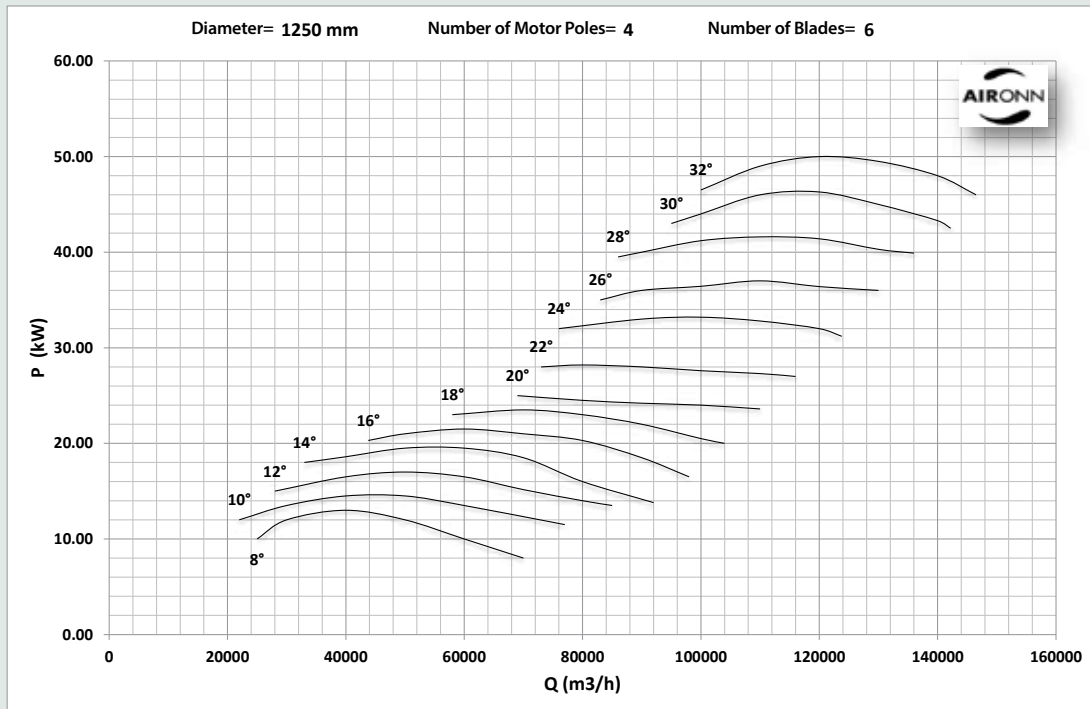
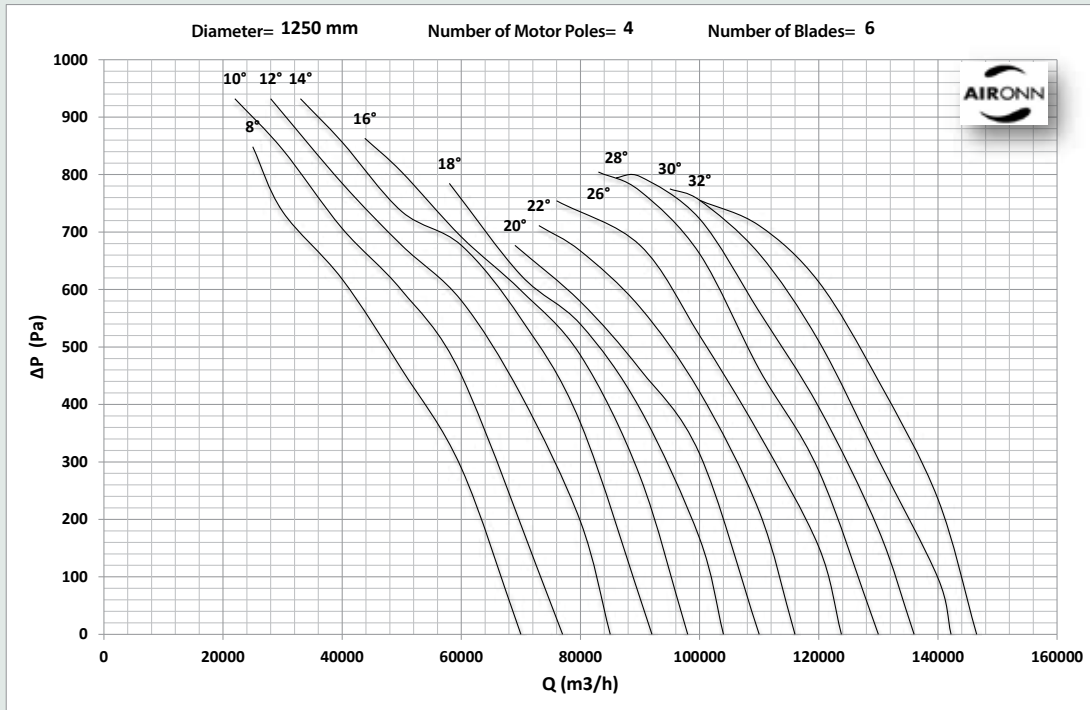

# Axial Type Silencer Body Smoke Exhaust Fan

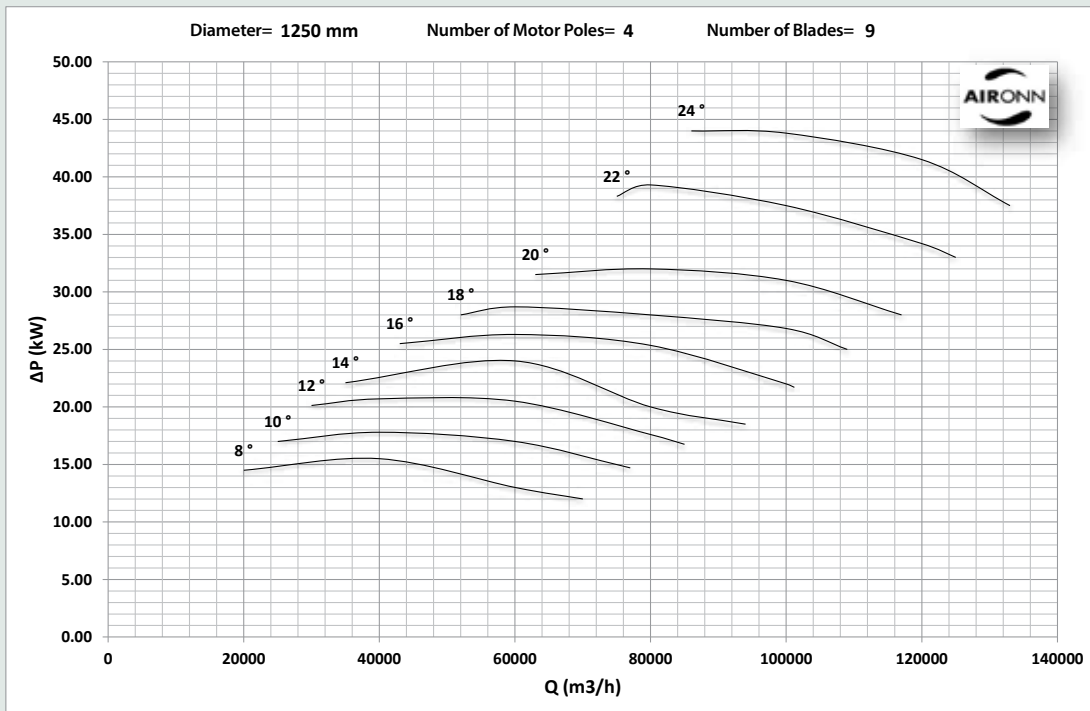
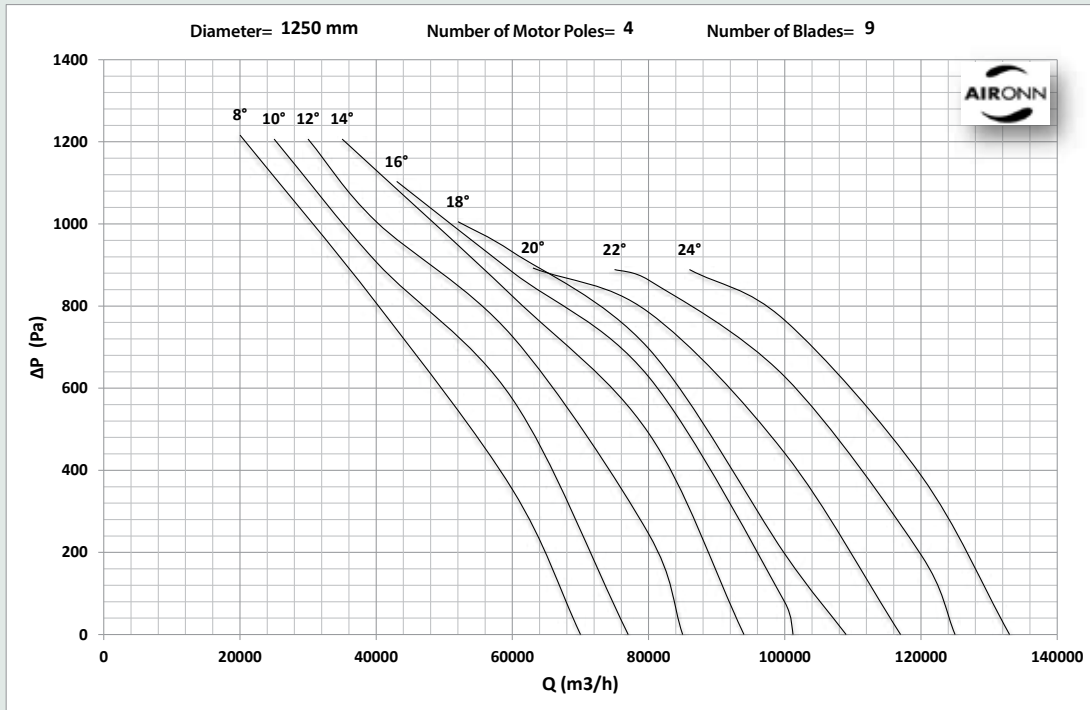









“FAN ENGINEERING”

AIRONN HAVALANDIRMA VE KLİMA SİSTEMLERİ SAN. DIŐ TİC. LTD. ŐTİ.

Tatlısu Mah. Őenol GneŐ Bulvarı Mira Tower K: 3 D: 16 Őerifali, AtaŐehir - İstanbul / Turkey

Phone: +90 216 594 56 96 Fax: +90 216 594 57 17 E-mail: info@aironn.com.tr

[www.aironn.com.tr](http://www.aironn.com.tr)